



ELEVATOR CABLING SYSTEMS

Power and data for modern elevators

TRADITION ♦ INNOVATION ♦ PASSION





CONTENTS

	page
<hr/>	
Elevator cabling systems	4
Product overview	6
Quality from first to last millimeter	8
Product features: explanation of pictograms	10
The most important test procedures and their functions	11
<hr/>	
Flat cables	
Product overview and selection criteria for Datwyler elevator cables	12
Datwyler Module Concept	14
Elevator suspension cables – PVC	16
Module Concept – PVC	24
<hr/>	
Accessories	
Suspension devices	36
Installation tools	38
<hr/>	
Information	
Harnessing	39
Logistics	40
<hr/>	



Office buildings



Shopping centres



Industry & Manufacturing



DELIVERING EXCELLENCE EVERY TIME, EVERYWHERE

The “lifeblood” of a modern public or commercial building is the functionality and reliability of the system solutions for communications, power supply, safety and elevator.

This is true of any such construction, irrespective of whether it is an office block, a hotel, a sports stadium, a television studio or a tunnel.



Public buildings



Data centres



Fibre to the Home

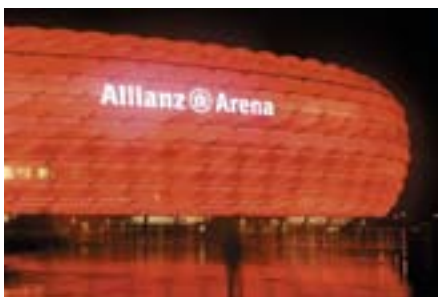

Event arenas



Hospitals

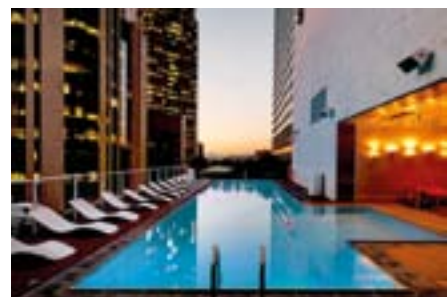

Hotels & Resorts



Transport hubs



Tunnels

Choose a reliable
system partner
right from the start:

choose Datwyler

POWER AND DATA
for modern elevators

ELEVATOR CABLING SYSTEMS



Unnoticed by elevator passengers, elevator cables from Datwyler Cabling Solutions do their job around the world every day. They reliably transfer power and data between the elevator cabin and the control system. Withstanding great mechanical stress, they provide faultless operation round the clock. No wonder Datwyler elevator cables are installed in the fastest elevators and the highest buildings in the world.

Space in cities is limited. High-rises are being erected around the globe. Elevators with ever greater performance are providing rapid access to the upper floors of these tall buildings. And so the requirements for the materials used are becoming increasingly tougher.

As a leading manufacturer of elevator cable systems, Datwyler knows the needs. Not only international standards must be met, but knowledge of customers' specific needs is essential. Our reliable elevator cable systems are known for smooth operation that adds significant comfort to the ride.

Leading know-how

Using various test methods, some of which were developed by Datwyler, we produce elevator cables for service under the toughest conditions. Our specialists define materials and designs that even under permanent dynamic loading show no signs of fatigue. We also offer halogen-free materials for special fire safety concepts.



Spinnaker Tower, Portsmouth

Selected reference projects

Shanghai Oriental Pearl Tower	Shanghai	Post Tower, German Post headquarters	Bonn
Canary Wharf	London	Torre Major	Mexiko City
Capital Towers	Dubai	Spinnaker Tower	Portsmouth
New World Trade Center	New York		

Diverse applications

Datwyler elevator cable systems meet every requirement for electrical connections to the elevator cabin. Aside from power cables, high-quality data cables are being increasingly requested. Integral fibre optic cable can easily handle large volumes of data. These modern system solutions connect the elevator cabin to the controls and to the local data network – so passengers can enjoy television and video services in the elevator.

Customer value in focus

Datwyler has developed innovative solutions for all current needs. Comprehensive harnessing and logistics services with modern B2B connectivity round off the service offering.

PRODUCT OVERVIEW

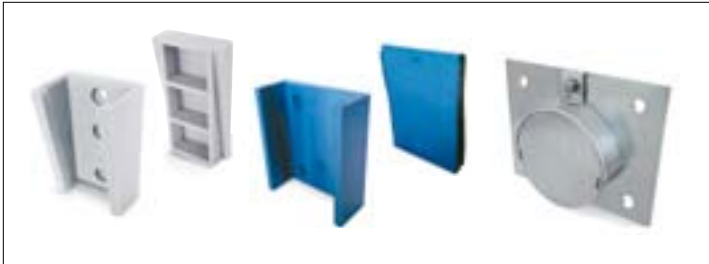

Suspension devices
for Datwyler FL, FM, FH



Installation tools
for simple installation
of FL, FM and FH cables

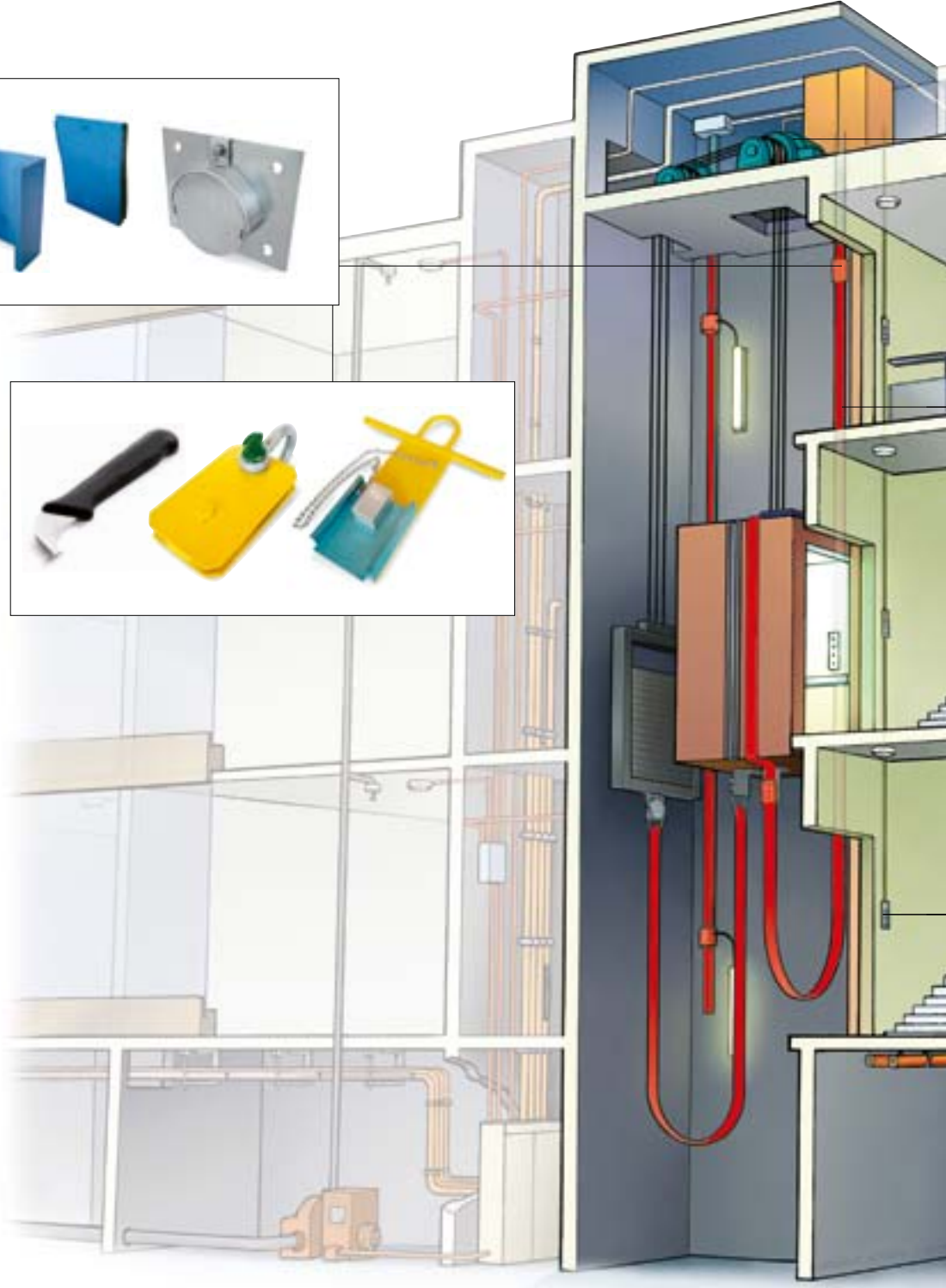



Pre-assembled machine room cabling (MRC)
ready for installation



Flat cables
FL, FM, FH
and Module Concept,
PVC and Low Fire Hazard

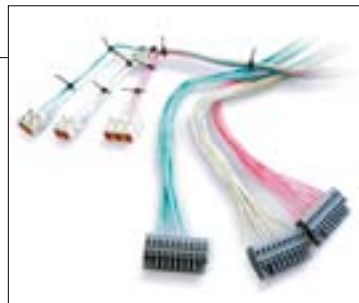

Pre-assembled hoistway cables/wires (HW)
ready for connection



Pre-assembled travelling cables (TC)
for all travelling heights

QUALITY FROM FIRST TO LAST MILLIMETER

Datwyler flat elevator cable - a pioneering achievement



Buildings are reaching up to the sky all around the globe. More and more people and goods must be transported faster, more comfortably and more safely in elevators. The "electronic revolution" during the past 30 years has also set entirely new standards in elevator construction. Video cameras monitor the elevator cars. Telephones provide connection with the building service and passengers are accompanied by music on their ascent or descent. What was once futuristic is now reality.

Consequently, modern elevators throughout the world are inconceivable today without well-devised electronic control systems, combined with an absolutely reliable and fault-free signal transmission and energy supply. Datwyler began addressing these requirements many years ago, and since then has clearly signalled the intention to lead the way.

It was always the aim to produce a cable which – with respect to mobility, safety, durability and silent running – was superior to any round cable and satisfied the high technical demands of elevator manufacturers. This has been achieved by the elevator cable specialists at Datwyler in close collaboration with leading elevator manufacturers. A range of flat elevator cables suitable for these applications has meanwhile been produced and proven in practice, backed by pioneering spirit, ambition and intensive research.

More security thanks to Datwyler flat cables

The unique cable design, the careful choice of high-grade raw materials, the absolutely precise workmanship with the latest production systems and the strict internal quality control guarantee Datwyler flat cable a long and trouble-free service life. This also applies to the appropriate suspension devices, fixing material and accessories. Datwyler is therefore making a decisive contribution towards the security of the entire elevator system, both in PVC as well as in zero-halogen designs.

Complete cable systems for all elevator shaft heights

Whether simple standard cables or cables with integral data, telephone and video components: Datwyler flat cables are just as versatile and efficient in elevator shafts up to 80 m high as in those up to 150 m or 400 m. In addition, all cable types can be installed very easily and quickly with the appropriate suspension devices, fixing material and accessories. The decisive factors for installation are primarily the type of cable, height of elevator shaft and free suspension length:

Cable type	Shaft height	Free suspension length	Speed
FL	up to 80 m	maximum 45 m	4 m/s
FM	up to 150 m	maximum 80 m	6.3 m/s
FH	up to 400 m	maximum 220 m	12 m/s

In parallel with the development and manufacturing of elevator cables, Datwyler has also played an active role in other fields of cable production: from power supply and safety cables to (copper and fibre optic) data cables.

In other words: know-how which will certainly benefit you as an elevator manufacturer, particularly where the total electrical package in the elevator shaft is concerned.

High quality standards

Quality cannot be dictated. Quality can only be achieved by the commitment of employees with a sense of responsibility.

Datwyler has done its utmost for many years to encourage this commitment. Year on year, we invest in even better materials and process technologies, production resources and test methods. This is why our products and system solutions always keep ahead of the current norms and repeatedly set new standards.

The important functions which our solutions must deliver in practice demand the highest possible level of safety and reliability. This is why we measure each product against stringent quality standards before it leaves the company. Of course, our management system is ISO 9001 / ISO 14001 / BS 18001 certified.

Our workforce accepts that we operate a no-compromise quality policy, which is in itself a warranty undertaking towards our customers.

In addition to general quality assurance Datwyler flat cables are subjected to additional test procedures specific to the application. For these testing procedures Datwyler has developed a whole series of high precision testing systems with the support of qualified specialists which make an exhaustive check of every type of cable. In this way we can ensure that our products comply with the high demands of our customers, with no "ifs" and "buts".

You need high-quality system solutions designed right from the start to handle the changing needs of users and future technical developments thereby guaranteeing they will have a long useful working life. Our sustainable solutions provide you with high-level operational reliability coupled with low operating costs.

The proof that Datwyler systems can deliver these benefits has been evident for many years in hundreds of installations around the world.



Check of dimensions in accordance with EN 60811

This test checks adherence to the wall thicknesses and external dimensions of the cable sheath required by the standard. Measurement is made on the basis of digital picture processing. The sheath profile of flat cables is identified, analysed and measured.

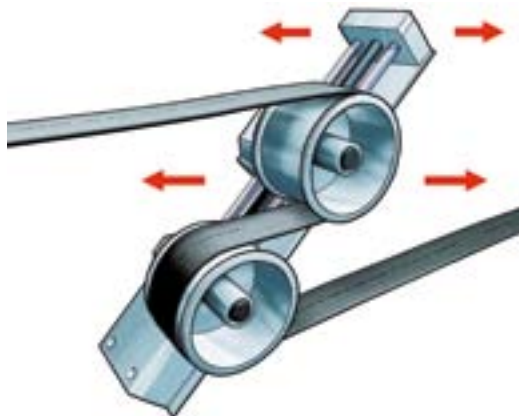

Alternating flexing test in accordance with EN 50214, HD 21.2

This test checks the flexibility of the elevator cable. The cable is moved back and forth over two metal pulleys within a section of one metre. The transmission capability of the conductors is tested electronically throughout the entire duration of the test.

PRODUCT FEATURES

The following pictograms show the essential features of our products and give an easy reference to their performance in case of fire.

They are allocated to the articles on the data sheets and provide you with a quick overview



**Zero halogen,
non corrosive gases**

Cables are halogen-free and reduce possible damage to health or material to a minimum.

IEC 60754-1 and IEC 60754-2,
EN 50267-2-1, EN 50267-2-2, EN 50267-2-3
VDE 0482-267 part 2-1, 2-2 and 2-3



Flame propagation

Cables use a high-performance, flame retardant material that is self-extinguishing.

IEC 60332-1-2,
EN 60332-1-2,
VDE 0482-332-1-2



Flame spread

Cables are flame resistant and prevent the propagation of a fire from one location to another

IEC 60332-3-22 to 25 cat. A-D,
EN 60332-3-22 bis 25 cat. A-D,
VDE 0482-332-3-22 to 25 cat. A-D



Smoke density

Cables emit minimum smoke in the event of fire. Exit routes and fire brigade access are not restricted.

IEC 61034-1 and IEC 61034-2,
EN 61034-1 and EN 61034-2,
VDE 0482-1034 part 1 and 2

Environmentally-friendly materials

The insulation and sheathing material of Datwyler low fire hazard elevator cables contain no PVC and can therefore be disposed of safely. In this way Datwyler Cabling Solutions makes a significant contribution towards a cleaner and safer environment.

THE MOST IMPORTANT TEST PROCEDURES AND THEIR FUNCTIONS



Test on gases evolved during combustion

This test procedure provides information if the insulation material of the cable sheath creates corrosive gases in the event of fire.

Halogen parts or other material in small quantities can be easily identified with this test due to the strong change of pH and conductivity. The conductivity is $< 10\text{mS/mm}$

Standards

- IEC 60754-1 and IEC 60754-2
- EN 50267-2-1, EN 50267-2-2
- EN 50267-2-3
- VDE 0482-267 part 2-1, 2-2 and 2-3



Test for vertical flame propagation (single insulated wire or cable)

This test method tests a cable sample (length: 60 cm) for burning behaviour.

The flame must extinguish itself, and the burn damage must not reach the upper end of the cable sample.

Standards

- IEC 60332-1-2
- EN 60332-1-2
- VDE 0482-332-1-2

Test for vertical flame spread (bunched wires or cables)

This test method tests a cable bundle (length: 360 cm) with regard to fire propagation.

The flames must extinguish themselves, and burn damage must not exceed a defined height.

Standards

- IEC 60332-3-22 up to 25 Cat. A-D
- EN 60332-3-22 up to 25 Cat. A-D
- VDE 0482-332-3-22 up to 25 Cat. A-D

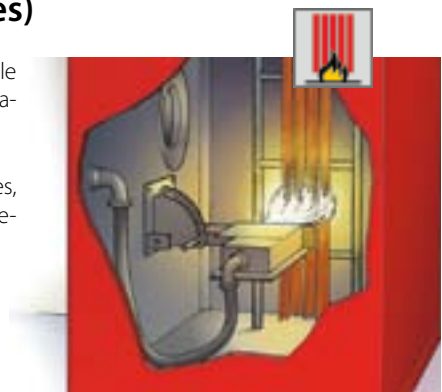

Measurement of smoke density

This test checks smoke development when burning the cable or the impairment of the visibility by burning cables.

The reduction in light transparency is measured in a standard chamber.

Standards

- IEC 61034-1 and IEC 61034-2
- EN 61034-1 and EN 61034-2
- VDE 0482-1034 part 1 and 2

Datwyler FH Module Concept

Innovative Datwyler Module Concept

for the simplest, safest and best choice of cable for shaft heights up to 400 m

Datwyler offers the best conditions for a choice of a functionally suitable cable with the new and unique Module Concept: quick, individual and economical.

Datwyler basic modules (4 to 8 bundle elements)

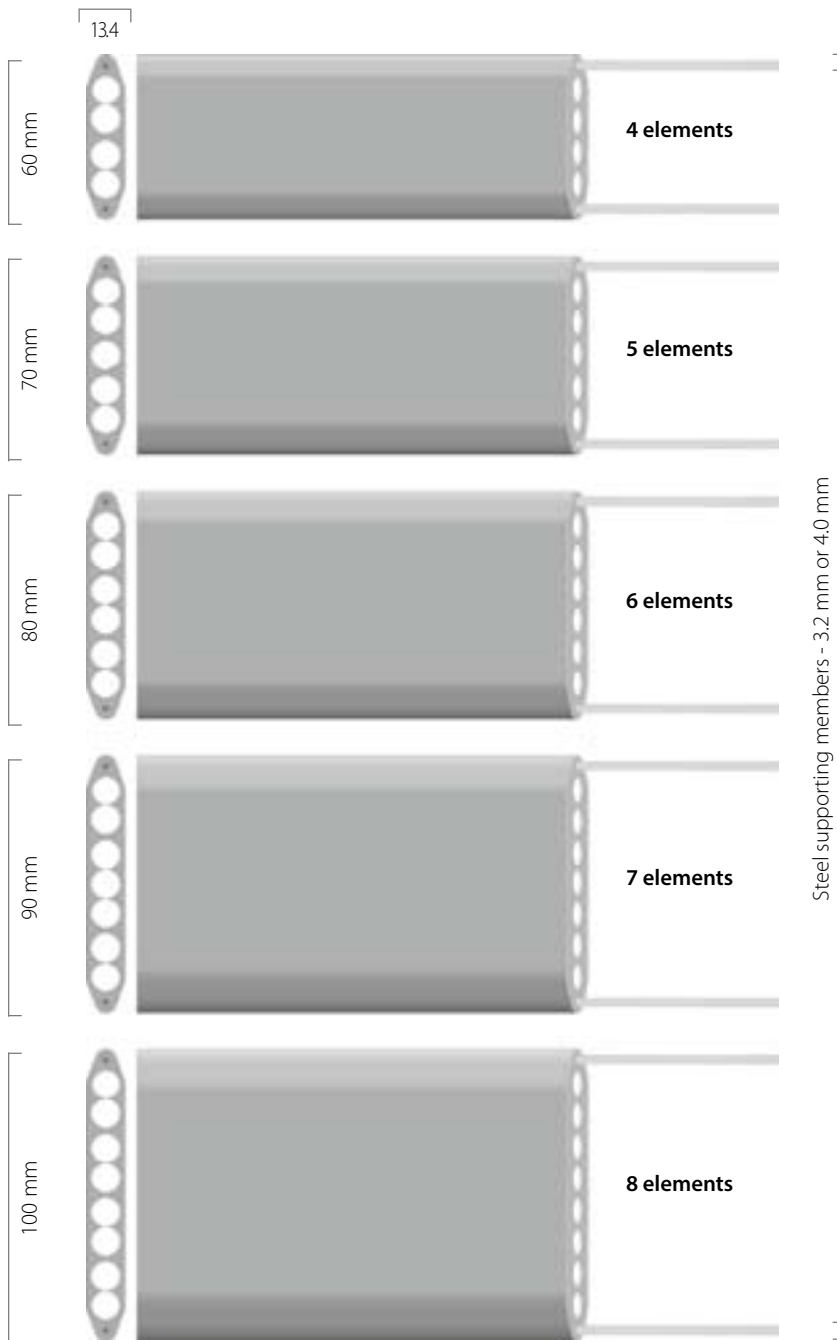

Module Concept:

PVC or LFH
(Safety - Low Fire Hazard)















For a range of active constructions
see pages 24/25 and 32/33

Advantages:

- Only one or maximum two cables are required even for the most complex functions
- Shorter installation times
- Less logistics expenditure
- Customized solutions

Innovative Datwyler Module Concept

Possible elements

Module type		Possible elements (international)	Dimensions	Integrated data elements
M1		CH-N05V-F 6240-F CH-N05Z-F 8570-F	12 x 0.75 mm ²	
M2		CH-N05V-F 6240-F CH-N05Z-F 8570-F	10 x 1.00 mm ²	
M3		CH-N07V-F 6240-F CH-N07Z-F 8570-F	7 x 1.50 mm ²	
M4		CH-N07V-F 6240-F CH-N07Z-F 8570-F	6 x 2.00 mm ²	
M5		CH-N07V-F 6240-F CH-N07Z-F 8570-F	5 x 2.50 mm ²	
M6		CH-N03EC4-F 8667/2-F	3 x 4 x 0.34 mm ²	8607-F STQ
M7		CH-N03EC7-F 8061/2-F	3 x 4 x 0.50 mm ²	6347/3-F STQ
M8		CH-N03EA7-F 8662/2-F	7 x 2 x 0.50 mm ²	6651/2-F FTP
M9		CH-N03EA7-F 8662/2-F	4 x 2 x 0.75 mm ²	6651/2-F FTP
M10		CH-N05V-Z 8811-Z CH-H05Z-Z 8823/2-Z	8 x 1.00 mm ² + 2 x optical fibre	GF-2314 50 µm GF-2314 62.5 µm
M11		CH-N05V-Z 8811-Z CH-H05Z-Z 8823/2-Z	6 x 1.00 mm ² + 4 x optical fibre	GF-2314 50 µm GF-2314 62.5 µm
M12		CH-N05V-Z 8811-Z CH-H05Z-Z 8823/2-Z	6 x 0.75 mm ² + 6 x optical fibre	GF-2314 50 µm GF-2314 62.5 µm
M13		CH-N03EA7-F 8662/2-F	4 x 2 x 0.50 mm ²	6651/2-F FTP
M14		CH-N03EC7Z1-F 8871-F	3 x 4 x 0.50 mm ²	6347/3-F STQ
M15		CH-N03EA7Z1-F 8870-F	7 x 2 x 0.50 mm ²	6651/2-F FTP

Note: This is a selection of possible module elements. Please refer to manufacturer to verify feasibility of your requested combination of elements.

ELEVATOR TRAVELLING CABLES

FL – PVC – unsupported

Low rise – travelling height maximum 80 m















Drawing according to article number 148779 – Type 6777-F

PRODUCT INFORMATION



APPLICATION	Elevator suspension cable for indoor and panoramic elevators.	
INSTALLATION	To comply with the correct installation procedures please refer to the Datwyler installation manual which is available separately.	
CONSTRUCTION	Core flexible:	Class 5
	Core insulation:	PVC
	Data elements:	none
	Supporting members:	none
	Outer sheath:	PVC
ELECTRICAL PROPERTIES	Rated voltage U ₀ /U:	according to table
MECHANICAL PROPERTIES	Free suspension length:	maximum 45 m
	Travelling height:	maximum 80 m
	Running speed:	maximum 4 m/s
	Acceleration:	< 0.8 m/s ²
	Operating temperature:	-15 to +70 °C
	Recommended loop diameter:	according to table, tolerance -50/+100 mm
COLOUR CODE	Core:	black, white numbered, G = with green-yellow core(s), JIF compliant types with different colours
	Outer sheath:	grey
STANDARD	 EN 50214	

Article no.	Type	Cross sectional area [n x mm ²]	Rated voltage U _o /U [V]	Overall dimensions approx. [w x h] [mm x mm]	Data elements	Weight approx. [kg/100m]	Copper content [kg/km]	Supporting members	Loop [mm]	Suspension device	Standards
148775	6777-F	4 G 0.75	300/500	13.0 x 4.5	none	8.9	29	none	300	LZ 1006	
148776	6777-F	6 G 0.75	300/500	18.7 x 4.3	none	13.6	43	none	300	LZ 1006	
148777	6777-F	12 G 0.75	300/500	34.0 x 4.3	none	25.8	87	none	300	LZ 1006	
155412	6777-F	16 G 0.75	300/500	44.7 x 4.3	none	34.2	115	none	300	LZ 1006	
148779	6777-F	18 G 0.75	300/500	49.3 x 4.3	none	38.0	130	none	300	LZ 1006	
148780	6777-F	20 G 0.75	300/500	55.2 x 4.3	none	42.5	144	none	300	LZ 1009	
148833	6777-F	24 G 0.75	300/500	65.6 x 4.3	none	50.9	173	none	300	LZ 1009	
185282*	6488-F	40 x 0.75	300/500	57.2 x 9.4	none	94.8	309	none	450	LZ 1009	
185283*	6488-F	60 x 0.75	300/500	79.9 x 10.5	none	145.7	446	none	500	LZ 1010	
148784	6777-F	12 G 1.00	300/500	35.3 x 4.4	none	29.2	115	none	300	LZ 1006	
154005	6777-F	18 G 1.00	300/500	51.1 x 4.4	none	43.2	173	none	300	LZ 1006	
148786	6777-F	20 G 1.00	300/500	57.6 x 4.4	none	48.3	192	none	300	LZ 1009	
148814	6777-F	24 G 1.00	300/500	68.4 x 4.4	none	57.8	230	none	300	LZ 1009	

*Bundle construction G = with green-yellow core(s)

Further dimensions on request

ELEVATOR TRAVELLING CABLES

FL – PVC – unsupported

Low rise – travelling height maximum 80 m















Drawing according to article number 167046 – Type 8326-F

PRODUCT INFORMATION



APPLICATION	Elevator suspension cable for indoor and panoramic elevators.	
INSTALLATION	To comply with the correct installation procedures please refer to the Datwyler installation manual which is available separately.	
CONSTRUCTION	Core flexible:	Class 5
	Core insulation:	PVC
	Data elements:	details according to page 34/35
	Supporting members:	none
	Outer sheath:	PVC
ELECTRICAL PROPERTIES	Rated voltage U ₀ /U:	according to table
MECHANICAL PROPERTIES	Free suspension length:	maximum 45 m
	Travelling height:	maximum 80 m
	Running speed:	maximum 4 m/s
	Acceleration:	< 0.8 m/s ²
	Operating temperature:	-15 to +70 °C
	Recommended loop diameter:	according to table, tolerance -50/+100 mm
COLOUR CODE	Core:	black, white numbered, G = with green-yellow core(s), JIS compliant types with different colours
	Pair/quad:	various colours or black with white numbers
	Coaxial :	grey
	Outer sheath:	grey
STANDARD	 EN 50214	

Article no.	Type	Cross sectional area [n x mm ²]	Rated voltage U ₀ /U [V]	Overall dimensions approx. [w x h] [mm x mm]	Data elements	Weight approx. [kg/100m]	Copper content [kg/km]	Supporting members	Loop [mm]	Suspension device	Standards
181658	8304-F	3 G 1.50 + 9 x 0.75 + 3 x 2 x 0.50	450/750 300/500 300/300	48.6 x 5.5	6651-F	44.3	143	none	350	LZ 1006	
185358	8798-F	12 G 0.75 + 1 x CX 75 Ω	300/500	42.3 x 6.5	HF-2122-F	43.8	111	none	400	LZ 1006	
167046	8326-F	20 x 0.75 + 2 x 2 x 0.50	300/300 300/300	52.0 x 5.3	6651-F	46.9	169	none	350	LZ 1006	
184758	8387-F	24 G 0.75 + 2 x 4 x 0.25	300/500 300/300	73.0 x 5.5	7954/2-F	69.7	216	none	350	LZ 1009	
167577	8506-F	4 x 1.50 + 2 x 1.00 + 2 x 4 x 0.50	450/750 300/500 300/500	34.1 x 7.6	8504-F	43.4	141	none	400	LZ 1006	
182298	8822-F	4 G 2.50 + 12 x 1.00 + 2 x 2 x 0.34 + 1 x CX 75 Ω	450/750 300/500 300/300	67.7 x 6.5	7345-F HF-2122-F	77.8	254	none	400	LZ 1009	
185281	8304-F	12 G 1.00 + 2 x 2 x 0.50	300/500 300/300	46 x 5.4	6651-F	42.2	140	none	350	LZ 1006	
181023	8606-F	3 G 2.50 + 14 x 1.00 + 4 x 2 x 0.34	450/750 300/500 300/300	72.0 x 5.7	7345-F	72.6	244	none	350	LZ 1009	
173814	8548-F	4 x 1.50 + 2 x 4 x 0.50 + 1 x CX 75 Ω	450/750 300/300	32.9 x 7.4	8504-F HF-2122-F	41.1	146	none	400	LZ 1006	
167019	8216-F	2 x 1.50 + 8 x 2 x 0.50 + 1 x CX 75 Ω	450/750 300/300	46.3 x 7.0	6651-F HF-2122-F	50.5	149	none	400	LZ 1006	
167567	8447-F	10 x 2 x 0.75	300/300	46.2 x 6.4	6651-F	43.6	171	none	400	LZ 1006	
191032	8867-F	4 x 4 x 2 x AWG26 G = with green-yellow core(s)	300/300	29.4 x 8.4	HF-4367-F	31.5	71	none	500	LZ 1006	

Further dimensions on request

ELEVATOR TRAVELLING CABLES

FM – PVC – supported

Mid rise – travelling height maximum 150 m

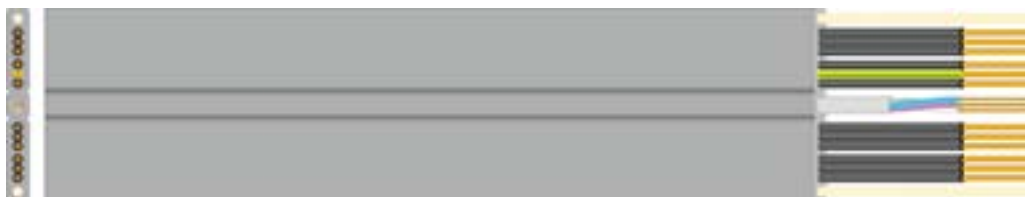

Drawing according to article number 177690 – Type 8666-F

PRODUCT INFORMATION



APPLICATION	Elevator suspension cable for indoor and panoramic elevators.	
INSTALLATION	To comply with the correct installation procedures please refer to the Datwyler installation manual which is available separately.	
CONSTRUCTION	Core flexible:	Class 5
	Core insulation:	PVC
	Data elements:	details according to page 34/35
	Supporting members:	HTF = High tensile fibre, ST = Steel, diameter in [mm]
	Outer sheath:	PVC
ELECTRICAL PROPERTIES	Rated voltage U ₀ /U:	according to table
MECHANICAL PROPERTIES	Free suspension length:	maximum 80 m
	Travelling height:	maximum 150 m
	Running speed:	maximum 6.3 m/s
	Acceleration:	< 1.2 m/s ²
	Operating temperature:	-15 to +70 °C
	Recommended loop diameter:	according to table, tolerance -50/+100 mm
COLOUR CODE	Core:	black, white numbered, G = with green-yellow core(s)
	Pair/quad:	various colours or black with white numbers
	Coax:	grey
	Outer sheath:	grey
STANDARD	 EN 50214	

Article no.	Type	Cross sectional area [n x mm ²]	Rated voltage U ₀ /U [V]	Overall dimensions approx. [w x h] [mm x mm]	Data elements	Weight approx. [kg/100m]	Copper content [kg/km]	Supporting members	Loop [mm]	Suspension device	Standards
165344	6599-F	24 G 0.75	300/500	73.1 x 4.3	none	54.9	173	HTF	300	LZ 1009	
156879	7770-F	24 G 0.75	300/500	73.2 x 4.3	none	59.0	173	ST Ø 2.5	400	LZ 1009	
176877	6900-F	6 G 1.50 + 6 x 1.00 + 1 x 4 x 0.50	450/750 300/500 300/300	53.0 x 6.4	6347/3-F	59.6	173	HTF	400	LZ 1006	
166612	7500-F	12 G 1.00 + 1 x CX 75 Ω	300/500	50.9 x 6.4	HF-2122-F	53.0	139	HTF	400	LZ 1006	
177690	8666-F	12 G 1.00 + 1 x 4 x 0.34	300/500 300/300	50.9 x 6.4	8607-F	52.5	142	HTF	400	LZ 1006	
167018	8210-F	2 x 1.50 + 1 x CX 75 Ω	450/750	54.1 x 7.1	HF-2122-F	58.0	149	HTF	450	LZ 1006	
168191	8210-F	4 x 1.50 + 2 x CX 75 Ω	450/750	64.3 x 7.0	6651-F	71.6	201	HTF	450	LZ 1009	
182058	8820-F	4 x 1.50 + 8 x 2 x 0.50 + 2 x CX 75 Ω	450/750	64.3 x 7.0	HF-2122-F 6651-F	74.5	201	ST Ø 2.5	500	LZ 1009	
168185	8507-F	12 x 2 x 0.50	300/300	54.1 x 5.6	6651-F	44.9	147	HTF	400	LZ 1006	
192360	8854/3-H	4 x 2 x 0.50	300/300	28.0 x 9.0	6651/3-H	31.1	56	ST Ø 2.5	450	LZ 1006	
191093	8512-F	3 G 2.50 + 14 x 1.00 + 4 x 2 x 0.50	450/750 300/500 300/300	79.0 x 5.7	6651-F	80.6	232	ST Ø 2.5	400	LZ 1009	
192453	8884-F	8 x 0.75 + 4 x FO G50/125	300/500	40.8 x 4.3	GF-2314	30.2	58	ST Ø 2.5	400	LZ 1006	

G = with green-yellow core(s)

ELEVATOR TRAVELLING CABLES

FH – PVC – supported

High rise – travelling height maximum 400 m



Drawing according to article number 161448 – Type 8292-F

PRODUCT INFORMATION



APPLICATION

Elevator suspension cable for indoor and panoramic elevators.

INSTALLATION

To comply with the correct installation procedures please refer to the Datwyler installation manual which is available separately.

CONSTRUCTION

Core flexible:	Class 5
Core insulation:	PVC
Data elements:	details according page 34/35
Supporting members:	ST = Steel, diameter in [mm]
Outer sheath:	PVC

ELECTRICAL PROPERTIES

Rated voltage U ₀ /U:	according to table
----------------------------------	--------------------

MECHANICAL PROPERTIES



Free suspension length:	maximum 220 m
Travelling height:	maximum 400 m
Running speed:	maximum 12 m/s
Acceleration:	< 1.2 m/s ²
Operating temperature:	-15 to +70 °C
Recommended loop diameter:	according to table, tolerance -50/+100 mm

COLOUR CODE

Core:	black, white numbered, G = with green-yellow core(s)
Pair/quad:	various colours or black with white numbers
Coax:	grey
Outer sheath:	grey

STANDARD

 EN 50214

Article no.	Type	Cross sectional area [n x mm ²]	Rated voltage U _o /U [V]	Overall dimensions approx. [w x h] [mm x mm]	Data elements	Weight approx. [kg/100m]	Copper content [kg/km]	Supporting members	Loop [mm]	Suspension device	Standards
157219	7877-F	40 x 0.75	300/500	69.0 x 9.4	none	111.4	309	ST Ø 2.5	550	LZ 4001	
185284	7877-F	60 x 0.75	300/500	89.3 x 10.5	none	161.0	446	ST Ø 3.2	550	LZ 4001	
161448	8292-F	40 G 0.75	300/500								
		+ 2 x 4 x 0.50	300/300		6347/2-F						
		+ 1 x CX 75 Ω		81.6 x 9.6	HF-2122-F	138.1	400	ST Ø 3.2	550	LZ 4001	
		G = with green-yellow core(s)									

Further dimensions on request

FH Module Concept – PVC

High rise – travelling height maximum 400 m







Drawing according to article number 185372 – Type 8847-F

PRODUCT INFORMATION



APPLICATION	Elevator suspension cable for indoor and panoramic elevators.	
INSTALLATION	To comply with the correct installation procedures please refer to the Datwyler installation manual which is available separately.	
CONSTRUCTION	Core flexible:	class 5
	Core insulation:	PVC
	Data elements:	details according to page 34/35
	Supporting members:	ST = Steel, diameter in [mm]
	Outer sheath:	PVC
ELECTRICAL PROPERTIES	Rated voltage U ₀ /U:	according to table
MECHANICAL PROPERTIES	Free suspension length:	maximum 220 m
	Travelling height:	maximum 400 m
	Running speed:	maximum 12 m/s
	Acceleration:	< 1.2 m/s ²
	Operating temperature:	-15 to +70 °C
	Recommended loop diameter:	approx. 600 mm, Tolerance -50/+150 mm
SUSPENSION DEVICE	LZ 4001	
COLOUR CODE	Core:	black, white numbered, G = with green-yellow core(s)
	Pair/quad:	various colours or black with white numbers
	Coax:	grey
	Optical fibres:	orange 50 µm, grey 62.5 µm
	Outer sheath:	grey
STANDARD		EN 50214

ELEVATOR TRAVELLING CABLES
FH Module Concept – PVC
 High rise – travelling height maximum 400 m

Article no.	Type	Cross sectional area [n x mm ²]	Rated voltage U ₀ /U [V]	Bundle type p. 17	No. of elements	Data elements	Overall dimensions approx. [w x h] [mm x mm]	Supporting members	Weight approx. [kg/100m]	Copper content [kg/km]	Standards
184646	8847-F	5 G 2.50 + 7 x 1.50 + 16 x 1.00 + 4 x 2 x 0.75 + 2 x FO G50/125 + 2 x FO G62.5/125	450/750 450/750 300/500 300/300	M5, M2, M9, M11, M3	5	6651/2-F GF-2314	70.0 x 13.4	ST Ø 4.0	152.5	448	
185372	8847-F	10 G 2.50 + 18 x 1.00 + 12 x 2 x 0.75 + 2 x FO G62.5/125	450/750 300/500 300/300	M5, M2 M9, M9 M9, M10, M5	7	6651/2-F GF-2314	90.0 x 13.4	ST Ø 4.0	198.7	629	
186276	8858-F	12 G 2.00 + 30 x 1.00 + 7 x 2 x 0.50 + 3 x 4 x 0.50	450/750 300/500 300/300	M4 M2, M8 M2, M7, M2, M4	7	6651/2-F 6347/3-F	88.7 x 13.4	ST Ø 4.0	196.8	698	
188337	8680-F	10 G 2.50 + 20 x 1.00 + 4 x 2 x 0.75 G = with green-yellow core(s)	450/700 300/500 300/300	M5, M2, M9, M2, M5	5	6651/2-F	70.0 x 13.4	ST Ø 4.0	155.7	513	

Further dimensions on request

Flat cables

Accessories

Information

ELEVATOR TRAVELLING CABLES

FL – Low Fire Hazard – unsupported

Low rise – travelling height maximum 80 m

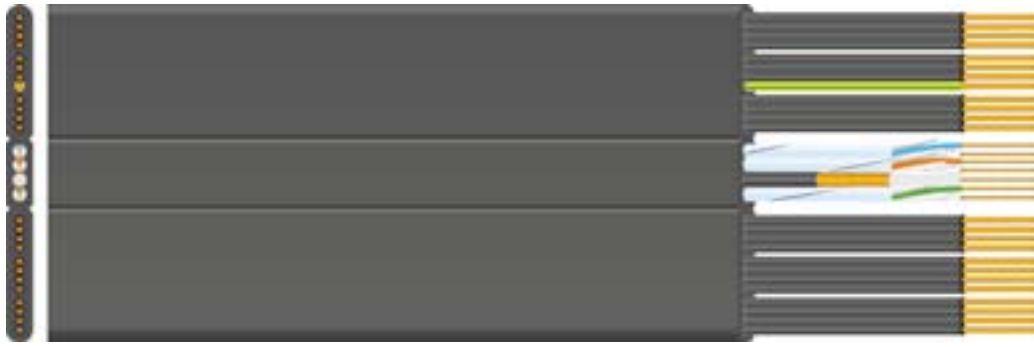

Drawing according to article number 191113 – Type 8582-F



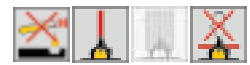



PRODUCT INFORMATION



APPLICATION	Elevator suspension cable for indoor and panoramic elevators.	
INSTALLATION	To comply with the correct installation procedures please refer to the Datwyler installation manual which is available separately.	
CONSTRUCTION	Core flexible:	Class 5
	Core insulation:	low fire hazard
	Data elements:	details according to page 34/35
	Supporting members:	none
	Outer sheath:	low fire hazard
ELECTRICAL PROPERTIES	Rated voltage U ₀ /U:	according to table
MECHANICAL PROPERTIES	Free suspension length:	maximum 45 m
	Travelling height:	maximum 80 m
	Running speed:	maximum 4 m/s
	Acceleration:	< 0.8 m/s ²
	Operating temperature:	-15 to +70 °C
	Recommended loop diameter:	according to table, tolerance -50/+100 mm
COLOUR CODE	Core:	black, white numbered, G = with green-yellow core(s)
	Pair/quad:	various colours or black with white numbers
	Coax:	black
	Outer sheath:	black
STANDARD	 EN 50214	

FL – Low Fire Hazard – unsupported

Low rise – travelling height maximum 80 m

Article no.	Type	Cross sectional area [n x mm ²]	Rated voltage U ₀ /U [V]	Overall dimensions approx. [w x h] [mm x mm]	Data elements	Weight approx. [kg/100m]	Copper content [kg/km]	Supporting members	Loop [mm]	Suspension device	Standards
191110	8511-F	12 G 0.75	300/500	34.3 x 4.4		26.0	87	none	300	LZ 1006	
185125	8511-F	18 G 0.75	300/500	49.4 x 4.4		38.4	130	none	300	LZ 1006	
191112	8511-F	24 G 0.75	300/500	66.7 x 4.4		51.4	173	none	300	LZ 1009	
191111	8636-F	12 G 0.75	300/500								
		+ 3 x 2 x 0.50	300/300	47.4 x 5.4	6651-F	42.7	123	none	400	LZ 1006	
182205	8827-F	3 G 2.50	450/750								
		+ 14 x 1.00	300/500								
		+ 4 x 2 x 0.34	300/300	72.3 x 5.8	7345-F	75.4	244	none	400	LZ 1009	
191113	8582-F	24 G 1.00	300/500								
		+ 3 x 2 x 0.75	300/300		6651-F						
		+ 1 x CX 75 Ω		87.3 x 6.5	HF-2123-F	97.4	306	none	400	LZ 1010	
190491	8582-F	2 x 1.50	450/750								
		+ 8 x 2 x 0.50	300/300		6651-F						
		+ 1 x CX 75 Ω		47.8 x 7.1	HF-2123-F	54.0	149	none	450	LZ 1006	
		G = with green-yellow core(s)									

Further dimensions on request

FM – Low Fire Hazard – supported

Mid rise – travelling height maximum 150 m

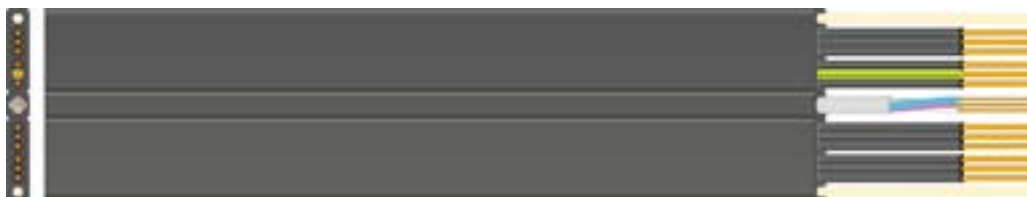

Drawing according to article number 185124 – Type 8696-F



PRODUCT INFORMATION



APPLICATION	Elevator suspension cable for indoor and panoramic elevators.	
INSTALLATION	To comply with the correct installation procedures please refer to the Datwyler installation manual which is available separately.	
CONSTRUCTION	Core flexible:	Class 5
	Core insulation:	low fire hazard
	Data elements:	details according to page 34/35
	Supporting members:	HTF = High tensile fibre
	Outer sheath:	low fire hazard
ELECTRICAL PROPERTIES	Rated voltage U ₀ /U:	according to table
MECHANICAL PROPERTIES	Free suspension length:	maximum 80 m
	Travelling height:	maximum 150 m
	Running speed:	maximum 6.3 m/s
	Acceleration:	< 1.2 m/s ²
	Operating temperature:	-15 to +70 °C
	Recommended loop diameter:	according to table, tolerance -50/+100 mm
COLOUR CODE	Core:	black, white numbered, G = with green-yellow core(s)
	Pair/quad:	various colours or black with white numbers
	Coax:	black
	Outer sheath:	black
STANDARD	 EN 50214	

FM – Low Fire Hazard – supported

Mid rise – travelling height maximum 150 m

Article no.	Type	Cross sectional area [n x mm ²]	Rated voltage U _o /U [V]	Overall dimensions approx. [w x h] [mm x mm]	Data elements	Weight approx. [kg/100m]	Copper content [kg/km]	Supporting members	Loop [mm]	Suspension device	Standards
185127	8622-F	12 G 1.00 + 1 x CX 75 Ω	300/500	48.4 x 6.0	HF-2123-F	49.8	139	HTF	400	LZ 1006	
185124	8696-F	12 G 1.00 + 1 x 4 x 0.34	300/300	48.4 x 6.0	8607-F	50.1	142	HTF	400	LZ 1006	
191094	8872-F	3 G 2.50 + 14 x 1.00 + 4 x 2 x 0.50	450/750 300/500 300/300	79.0 x 5.7	6651-F	83.8	232	HTF	400	LZ 1009	
G = with green-yellow core(s)											

Further dimensions on request

ELEVATOR TRAVELLING CABLES

FH – Low Fire Hazard – supported

High rise – travelling height maximum 400 m

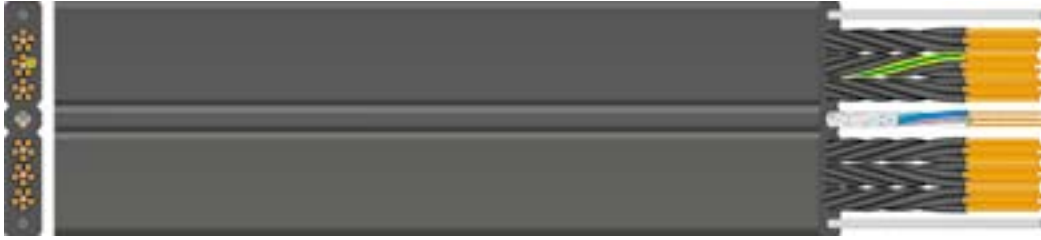

Drawing according to article number 185126 – Type 8585-F

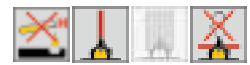

PRODUCT INFORMATION



APPLICATION	Elevator suspension cable for indoor and panoramic elevators.	
INSTALLATION	To comply with the correct installation procedures please refer to the Datwyler installation manual which is available separately.	
CONSTRUCTION	Core flexible:	Class 5
	Core insulation:	low fire hazard
	Data elements:	details according to page 34/35
	Supporting members:	ST = Steel, diameter in [mm]
	Outer sheath:	low fire hazard
ELECTRICAL PROPERTIES	Rated voltage U ₀ /U:	according to table
MECHANICAL PROPERTIES	Free suspension length:	maximum 220 m
	Travelling height:	maximum 400 m
	Running speed:	maximum 12 m/s
	Acceleration:	< 1.2 m/s ²
	Operating temperature:	-15 to +70 °C
	Recommended loop diameter:	according to table, tolerance -50/+100 mm
COLOUR CODE	Core:	black, white numbered, G = with green-yellow core(s)
	Pair/quad:	various colours or black with white numbers
	Outer sheath:	black
STANDARD	 EN 50214	

FH – Low Fire Hazard – supported

High rise – travelling height maximum 400 m

Article no.	Type	Cross sectional area [n x mm ²]	Rated voltage U _o /U [V]	Overall dimensions approx. [w x h] [mm x mm]	Data elements	Weight approx. [kg/100m]	Copper content [kg/km]	Supporting members	Loop [mm]	Suspension device	Standards
185126	8585-F	30 G 1.00 + 1 x 4 x 0.34	300/500 300/300	61.8 x 9.7	8607-F	106.8	335	ST Ø 2.5	550	LZ 4001	
192313	8880-F	12 G 0.75 + 24 x 2 x 0.75 + 1 x CX 75 Ω G = with green-yellow core(s)	300/500 300/300	98.5 x 14.5	6651/2-F HF-2123-F	188.3	532	ST Ø 4.0	550	LZ 4001	

Further dimensions on request

FH Module Concept – Low Fire Hazard

High rise – travelling height maximum 400 m



Drawing according to article number 191114 – Type 8859-F



PRODUCT INFORMATION



APPLICATION	Elevator suspension cable for indoor and panoramic elevators.	
INSTALLATION	To comply with the correct installation procedures please refer to the Datwyler installation manual which is available separately.	
CONSTRUCTION	Core flexible:	Class 5
	Core insulation:	low fire hazard
	Data elements:	details according to page 34/35
	Supporting members:	ST = Steel, diameter in [mm]
	Outer sheath:	low fire hazard
ELECTRICAL PROPERTIES	Rated voltage U ₀ /U:	according to table
MECHANICAL PROPERTIES	Free suspension length:	maximum 220 m
	Travelling height:	maximum 400 m
	Running speed:	maximum 12 m/s
	Acceleration:	< 1.2 m/s ²
	Operating temperature:	-15 to +70 °C
	Recommended loop diameter:	approx. 650 mm, tolerance -50/+150 mm
SUSPENSION DEVICE	LZ 4001	
COLOUR CODE	Core:	black, white numbered, G = with green-yellow core(s)
	Pair/quad:	various colours or black with white numbers, bundle with black sheath
	Coax:	black
	Optical fibres:	orange 50 µm, grey 62.5 µm
	Outer sheath:	black
STANDARD	 EN 50214	











FH Module Concept – Low Fire Hazard

High rise – travelling height maximum 400 m

Article no.	Type	Cross sectional area [n x mm ²]	Rated voltage U ₀ /U [V]	Bundle type p. 17	No. of elements	Data elements	Overall dimensions approx. [w x h] [mm x mm]	Supporting members	Weight approx. [kg/100m]	Copper content [kg/km]	Standards
191114	8859-F	12 G 2.00 + 30 x 1.00 + 7 x 2 x 0.50 + 3 x 4 x 0.50	450/750 300/500 300/300 300/300	M4, M2, M15, M2, M14, M2, M4	7	6651/2-F 6347/3-F	90.7 x 14.0	ST Ø 4.0	199.8	698	
191483	8866-F	10 G 2.50 + 7 x 1.50 + 6 x 1.00 + 12 x 2 x 0.75 + 4 x FO G50/125	450/750 450/750 300/500 300/300	M3 M5, M9 M5, M9 M11, M9	7	6651/2-F GF-2314	94.0 x 14.0	ST Ø 4.0	215.5	616	
G = with green-yellow core(s)											











Further dimensions on request

Data elements for Datwyler travelling cables

	Data element	Cross section	Colour code	Construction
1	 HF-4367-F	4 x 2 x AWG26 S/FTP	white/blue, red/orange, black/green, yellow/brown	PE cores Al/PETP foil per pair Overall tinned Cu wire braid PVC sheath
2	 7954/2-F	2 x 0.25 STP	white/blue	PE cores PE filler (2x) PETP tape Tinned Cu wire spiral PETP tape
3	 7345-F	2 x 0.34 FTP	various colours	PE cores PP filler (2x) PETP tape Tinned Cu drain wire Al/PETP foil
4	 7067/2-F (unshielded)	2 x 0.50 UTP	various colours	PE cores PP filler (2x) PETP tape
5	 6651-F	2 x 0.50 FTP	various colours	PE cores Tinned Cu drain wire with PP centre PP filler Al/PETP foil
6	 6651/2-F	2 x 0.50 FTP	black, white numbered	PE cores Tinned Cu drain wire with PP centre PP filler Al/PETP foil PP tape
7	 6651/3-H	2 x 0.50 FTP	black, white numbered	PE cores Tinned Cu drain wire with PP centre PP filler Al/PETP foil PP tape
8	 7954/2-F	2 x 0.50 STP	various colours	PE cores PE filler (2x) PETP tape Tinned Cu wire spiral PETP tape
9	 6651-F	2 x 0.75 FTP	various colours	PE cores Tinned Cu drain wire with PP centre PP filler Al/PETP foil
10	 6651/2-F, 6651/3-F	2 x 0.75 FTP	black, white numbered	PE cores Tinned Cu drain wire with PP centre PP filler Al/PETP foil PP tape

Note: All data elements on page 34/35 are semi-finished products and not available for individual sale.

Data elements for Datwyler travelling cables

	Data element	Cross section	Colour code	Construction
11	 7067/2-F (unshielded)	4 x 0.25 UTQ	various colours	PP centre PE cores PETP tape
12	 7954/2-F	4 x 0.25 STQ	various colours	PP centre PE cores PETP tape Tinned Cu wire spiral PETP tape (2x)
13	 8607-F	4 x 0.34 STQ	various colours	PE cores PP foam tape Tinned Cu wire braid PP tape
14	 6347/2-F	4 x 0.50 STQ	various colours	PE cores PP tape Tinned Cu wire spiral PP tape
15	 6347/3-F	4 x 0.50 STQ	various colours	PE cores PP tape Tinned Cu wire spiral PP tape (2x)
16	 8504-F	STQ	various colours	PE cores PETP tape Tinned Cu wire spiral PETP tape PVC sheath
17	 HF-2122-F (Coaxial cable 75 Ω)	n/a	grey	Bare Cu strand PE dielectric Al/PETP foil Tinned Cu wire braid PVC sheath
18	 HF-2123-F (Coaxial cable 75 Ω)	n/a	black	Bare Cu strand PE dielectric Al/PETP foil Tinned Cu wire braid Low fire hazard sheath
19	 GF-2314 (G50/125)	n/a	orange	Multimode fibre G50/125 µm OM2 Tight buffer Aramid yarn Low fire hazard sheath
20	 GF-2314 (G62.5/125)	n/a	grey	Multimode fibre G62.5/125 µm OM1 Tight buffer Aramid yarn Low fire hazard sheath

ACCESSORIES

Suspension devices
for FL and FM cables



Figure 1:
Suspension device LZ 1006



Figure 2:
Suspension device LZ 1009

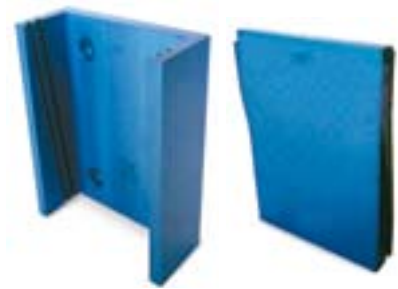

Figure 3:
Suspension device LZ 1010

PRODUCT INFORMATION

APPLICATION

Suspension devices for Datwyler FL and FM elevator travelling cables.

The cable width, the number of cables (cable combinations) to be mounted and the travelling height determine the selection of the correct cable suspension device(s).

To this end, please note the maximum clamping thickness of the individual suspension parts.

MATERIAL

Nylon PA6
Aluminium

LZ 1006 / LZ 1009
LZ 1010

grey
blue anodised

DIMENSIONS

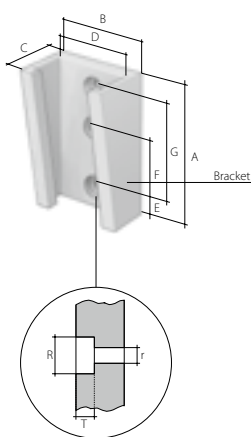

LZ 1006

- A = 100 mm
- B = 65 mm
- C = 47 mm
- D = 55 mm
- E = 13,5 mm
- F = 43 mm
- G = 73 mm
- R = Ø 13,9 mm
- r = Ø 6,45 mm
- T = 5,2 mm

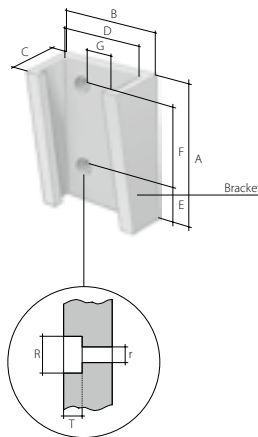

LZ 1009

- A = 120 mm
- B = 92 mm
- C = 51,5 mm
- D = 79 mm
- E = 27 mm
- F = 73 mm
- G = 40 mm
- R = Ø 13,9 mm
- r = Ø 6,45 mm
- T = 5,2 mm

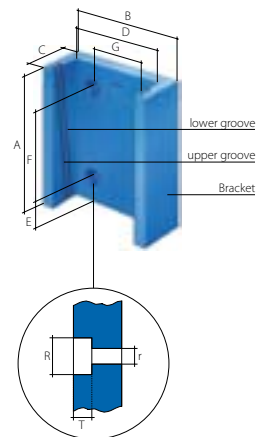

LZ 1010

- A = 140 mm
- B = 120 mm
- C = 50 mm
- D = 100 mm
- E = 22 mm
- F = 96 mm
- G = 60 mm
- R = Ø 15,0 mm
- r = Ø 9,0 mm
- T = 6,0 mm

Article no.	Type	Colour	Cable clamping range maximum	Width of cable	Screw holes	Figure
179813	LZ 1006	grey	3 - 12 mm	≤ 55 mm	3	1
179814	LZ 1009	grey	3 - 15 mm	≤ 56 - 79 mm	4	2
163354	LZ 1010	blue	3 - 22 mm	≤ 80 - 100 mm	4	3

**Suspension device
for FH cables**



Figure 1:
Suspension device LZ 4001
for FH cables



Figure 2:
Screw set M12x40
for car/counter weight



Figure 3:
Hilti HSL-3 M8/20
for shaft wall

PRODUCT INFORMATION

APPLICATION

Steel suspension device for a maximum of two Datwyler FH elevator travelling cables.

INSTALLATION

The following installation screw sets are available for LZ 4001:

- Elevator car or counter weight: 4 bolts M12x40 including spring-washer, washer and nut (see figure 2), bolt: property class 8.8/8 (nut)
- Shaft wall: 4 Hilti HSL-3 M8/20 (see figure 3), (minimum concrete strength required: $b_w = 30 \text{ N/mm}^2$)

DIMENSIONS

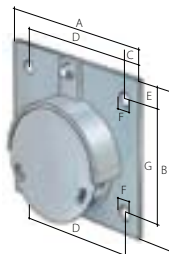

LZ 4001

- A = 220 mm
 - B = 170 mm
 - C = 30 mm
 - D = 160 mm
 - E = 25 mm
 - F = $\varnothing 13 \text{ mm}$
 - G = 120 mm
- thickness of ground plate = 5 mm

CRIMPING SLEEVE

For recommended crimping sleeves see "Installation tools" (page 38).

Suspension device LZ 4001 for FH cables:

Article no.	Type	Figure
184606	LZ 4001	1

Installation kits:

Article no.	Type	Application	Figure	PU
185214	Screw set M12x40	for fixing to elevator car or counter weight	2	2 pcs.
185215	Hilti HSL-3 M8/20	for fixing to shaft wall	3	2 pcs.

ACCESSORIES

Installation tools

Fig. 1: AV 150



Fig. 2: AV 400

Fig. 3: FH tool box (Fig. 2-11: contents)



PRODUCT INFORMATION

DESCRIPTION

AV 150 and AV 400 installation aid:

Datwyler flat cables are most easily and quickly drawn in using the AV installation aid. The AV 150 is suitable for elevator shaft heights up to 150 m. The AV 400 is suitable for elevator shaft heights up to 400 m. The AV 400 indispensable component is also part of the FH tool box (Article no. 179278) which contains all the tools and accessories necessary for installing Datwyler FH cables.

Professional FH tool box:

with indispensable tools and accessories for installation of FH cables

- Contents:
- 4. Wire rope cutter, big cuts steel wire ropes up to diameter of 8 mm
 - 5. Wire rope cutter, small cuts steel wire ropes up to diameter of 4 mm
 - 6. Stripping knife special knife to commence the removal of the cable jacket
 - 7. Crimping tool tool for splicing of steel wire ropes
 - 8. Crimping sleeves for rope diameters from 2.5 to 6 mm
 - 2. Two auxiliary devices AV 400 for elevator shaft heights up to 400 m
 - 9. Universal scissors
 - 10. Steel wire ropes

Cutters, crimping tool, crimping sleeves, etc.:

The above mentioned accessories are also available separately.

Article no.	Figure	Type	Description
176812	1	AV 150	for elevator shaft heights up to 150 m
176811	2	AV 400	for elevator shaft heights up to 400 m
179278	3	FH tool box	
184575	4	Wire rope cutter, big	cuts steel wire ropes up to diameter of 8 mm
166670	5	Wire rope cutter, small	cuts steel wire ropes up to diameter of 4 mm
163358	6	Stripping knife	special knife to commence the removal of the cable jacket
166667	7	Crimping tool	tool for splicing of steel wire ropes
166668	8	Crimping sleeves SL 2-3	for rope diameter of 2.5 mm Set of 10 pieces
166669	8	Crimping sleeves SL 2-4	for rope diameter of 3.0 mm Set of 10 pieces
166669	8	Crimping sleeves SL 2-4	for rope diameter of 3.2 mm Set of 10 pieces
182059	8	Crimping sleeves SL 2-5	for rope diameter of 4.0 mm Set of 10 pieces
182060	8	Crimping sleeves SL 2-6	for rope diameter of 5.0 mm Set of 10 pieces
182061	8	Crimping sleeves SL 2-7	for rope diameter of 6.0 mm Set of 10 pieces
179472	9	Universal scissors	

We provide the following services:

- **Harnessing**
- **Logistics**
- **Consulting and engineering**

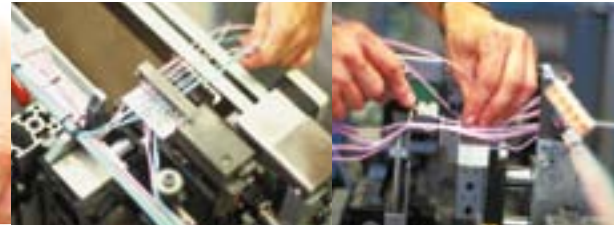

Harnessing

Solutions for elevator manufacturers (100% tested, ready for plug and play):

- Paper-free CIM production
- Shaft wiring/cabling
- Machine room and drive cables
- Cabin terminal boxes
- Travelling cables
- Additional components:
door cables, bells, horns, position tracking systems

Solutions for industry:

Paper-free CIM production,
single cables, cable groups, complex cabling

We can provide a suitable system solution for most applications.

With harnessing plants in different locations we are in the position to offer small, medium and large production runs at very competitive prices.

Communication

Order transmission and order confirmation by B2B via Internet.

Example of elevator B2B process

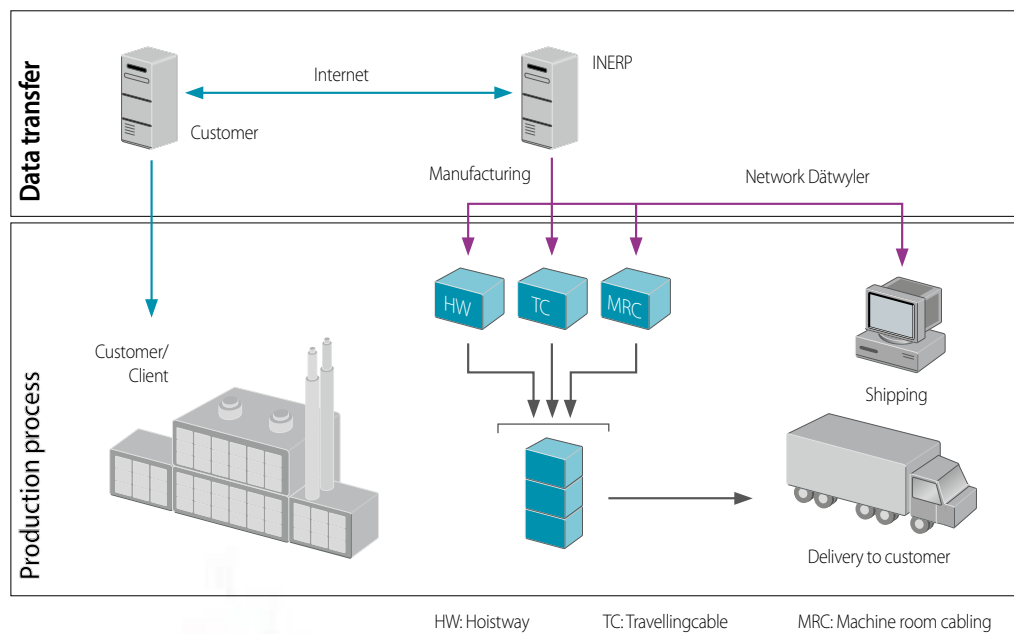

Our services include

- Comprehensive consulting and engineering in harnessing
- EDI order communication, B2B via Internet
- Procurement and inclusion of additional components
- Complete packing and dispatch logistics

Logistics

- Component packing
- Barcode labels
- Loose parts commissioned
- Just-in-time delivery, world-wide

FURTHER DATWYLER PRODUCT LINES

Are you interested in Datwyler's high-quality products and solutions?
Then please visit our home page at www.cabling.datwyler.com.

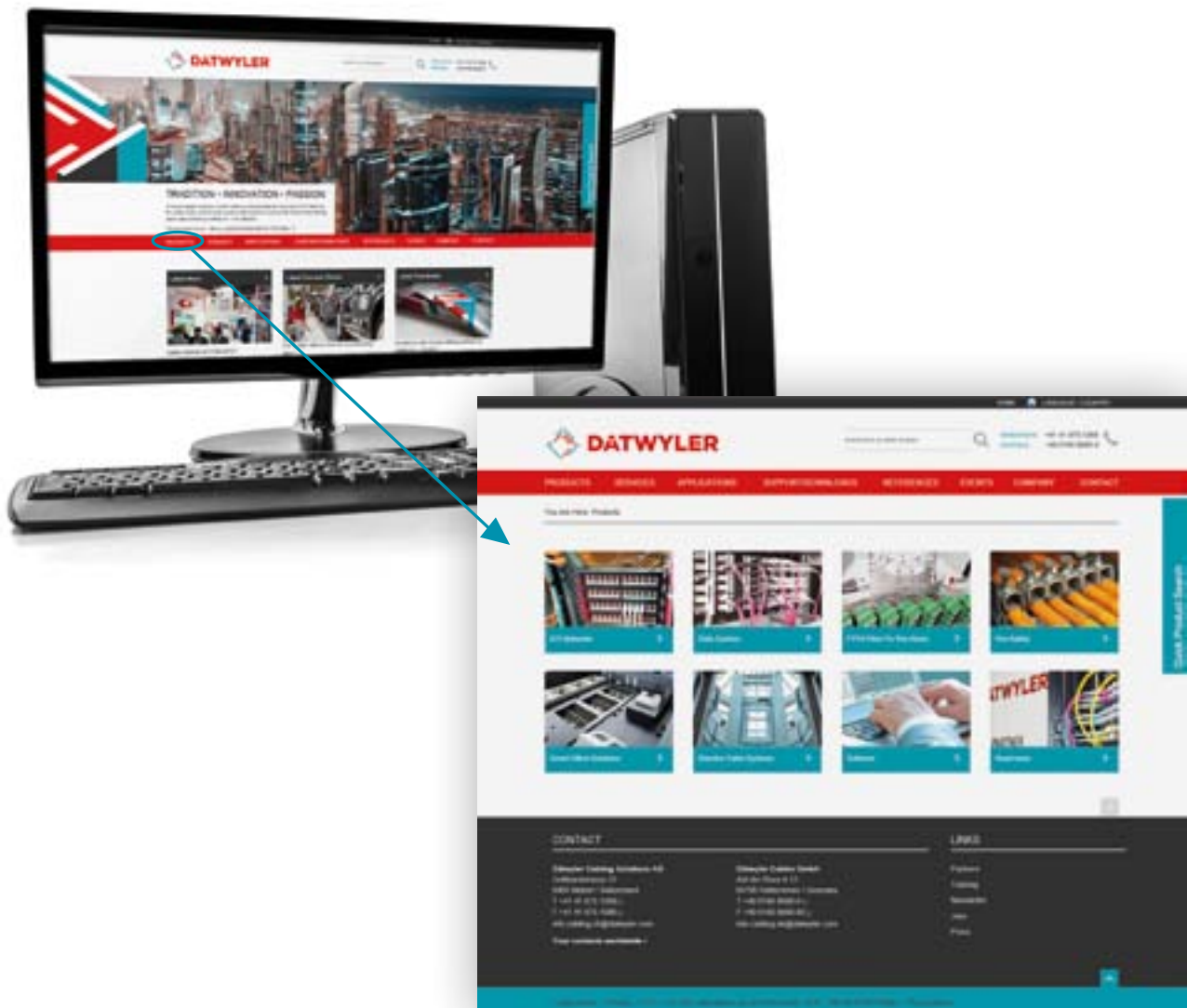





www.cabling.datwyler.com

LOCATIONS

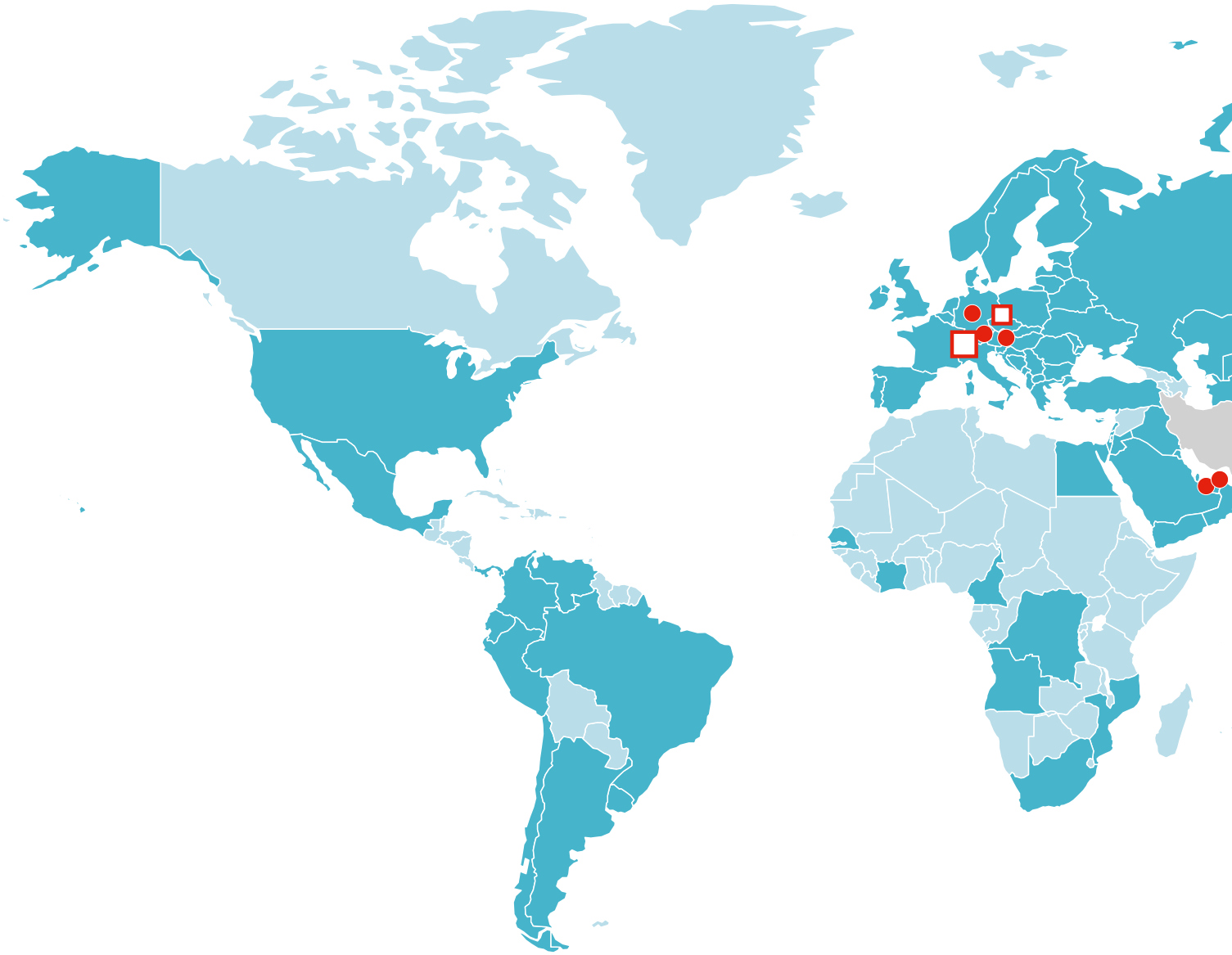
Offices and distribution partners

GLOBAL MARKET COMPETENCE



-  Datwyler Headquarters and Manufacturing Plant
-  Datwyler Manufacturing Plants
-  Datwyler Offices
-  Active Market Presence: Datwyler and its Distribution Partners

Are you searching for a distribution partner in your vicinity?
Please visit www.cabling.datwyler.com for details of our partners
or contact our relevant branches.



EUROPE / CENTRAL ASIA / TRANSCAUCASIA / AMERICA

Dätwyler Cabling Solutions AG
Gotthardstrasse 31, 6460 Altdorf / Switzerland
T +41 41 875-1268, F +41 41 875-1986
info.cabling.ch@datwyler.com

Dätwyler Cables GmbH
Auf der Roos 4-12, 65795 Hattersheim / Germany
T +49 6190 8880-0, F +49 6190 8880-80
info.cabling.de@datwyler.com

Dätwyler Cables GmbH, Office Austria
Liebermannstraße A02 403, 2345 Brunn am Gebirge / Austria
T +43 1 8101641-0, F +43 1 8101641-35
info.cabling.at@datwyler.com

SOUTH EAST ASIA / PACIFIC

Datwyler (Thelma) Cables+Systems Pte Ltd
30 Toh Guan Road # 01-01A
608840 Singapore
T +65 68631166, F +65 68978885
info.cabling.sg@datwyler.com

CHINA

Datwyler (Suzhou) Cabling Solutions Co., Ltd.
No. 218, East Beijing Road
Taicang Economic Development Zone
Jiangsu Province, 215413 / P. R. China
T +86 512 3306-8066, F +86 512 3306-8049
info.cabling.cn@datwyler.com

MIDDLE EAST / AFRICA

Datwyler Middle East FZE
Jabel Ali Free Zone
LB 15, Second Floor, Room #10 & 11
P.O. Box 263480
Dubai / United Arab Emirates
T +971 4 4228129, F +971 4 4228096
info.cabling.ae@datwyler.com

Datwyler Cabling Solutions LLC
Unit 1004 & 1005, 10th Floor, IB Tower
Business Bay
Dubai / United Arab Emirates
T +971 4 4228129, F +971 4 4228096
info.cabling.ae@datwyler.com



DATWYLER

SWITZERLAND

Dätwyler Cabling Solutions AG

Gotthardstrasse 31
6460 Altdorf
T +41 41 875-1268
F +41 41 875-1986
info.cabling.ch@datwyler.com
www.cabling.datwyler.com

GERMANY

Dätwyler Cables GmbH

Auf der Roos 4-12
65795 Hattersheim
T +49 6190 8880-0
F +49 6190 8880-80
info.cabling.de@datwyler.com
www.cabling.datwyler.com

Dätwyler Cables GmbH
Lilienthalstraße 17
85399 Hallbergmoos
T +49 811 998633-0
F +49 811 998633-30
info.cabling.de@datwyler.com
www.cabling.datwyler.com

AUSTRIA

Dätwyler Cables GmbH Office Austria

Liebermannstraße A02 403
2345 Brunn am Gebirge
T +43 1 8101641-0
F +43 1 8101641-35
info.cabling.at@datwyler.com
www.cabling.datwyler.com

UNITED ARAB EMIRATES

Datwyler Middle East FZE

Jabel Ali Free Zone
LB 15, Second Floor, Room #10 & 11
P.O. Box 263480
Dubai
T +971 4 4228129
F +971 4 4228096
info.cabling.ae@datwyler.com
www.cabling.datwyler.com

Datwyler Cabling Solutions LLC

Unit 1004 & 1005, 10th Floor, IB Tower
Business Bay
Dubai
T +971 4 4228129
F +971 4 4228096
info.cabling.ae@datwyler.com
www.cabling.datwyler.com

CHINA

Datwyler (Suzhou) Cabling Solutions Co., Ltd.

No. 218, East Beijing Road
Taicang Economic Development Zone
Jiangsu Province, 215413
T +86 512 3306-8066
F +86 512 3306-8049
info.cabling.cn@datwyler.com
www.cabling.datwyler.cn

SINGAPORE

Datwyler (Thelma) Cables+Systems Pte Ltd

30 Toh Guan Road #01-01A
608840 Singapore
T +65 68631166
F +65 68978885
info.cabling.sg@datwyler.com
www.cabling.datwyler.com