



ICT NETWORKS

Scalable solutions for high performance network infrastructures

TRADITION ♦ INNOVATION ♦ PASSION



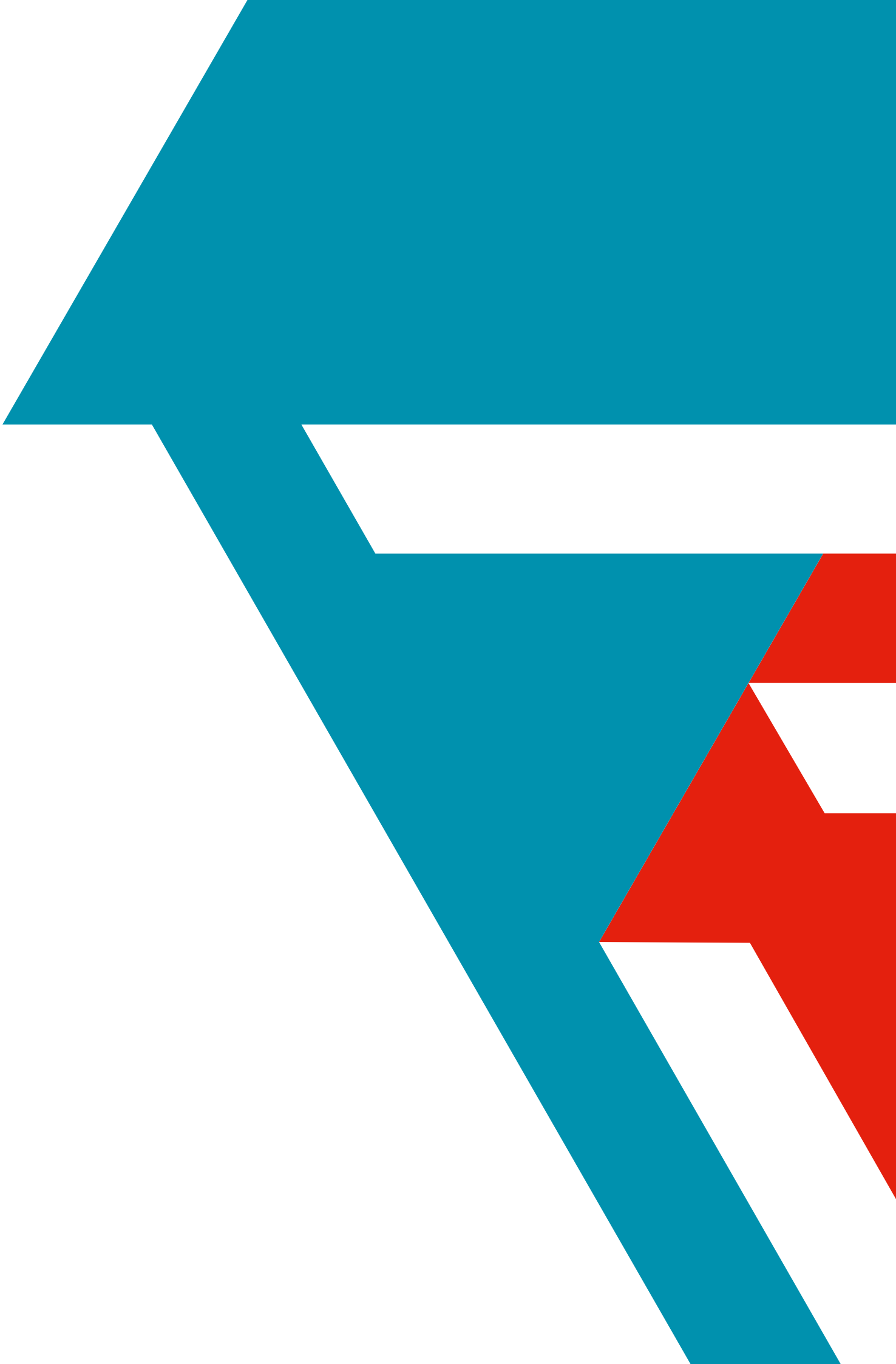

CONTENTS

	page		page
About us	2	Product features: Legend of pictographs	14
ICT Networks	7	The most important test procedures and their functions	16
ICT Product Overview	10	ROHS – WEEE – REACH	20

COPPER TECHNOLOGY

Product overview and selection guide for copper data cables	21	Connecting technology Cat.6/E _A shielded	112
At a glance guide: Copper data cables, by Category	22	Connecting technology Cat.6, shielded	116
At a glance guide: Copper connecting hardware, by Category	24	Connecting technology Cat.5e, shielded	119
Data cables, shielded	26	Connecting technology Cat.6, unshielded	120
Data cables, unshielded	76	Connecting technology Cat.3, unshielded	123
Telephone cables	82	Faceplates	124
Trunks	88	Patch panels	143
Patch cords	93	Industrial	157
Connecting technology Cat.7 _A shielded	104	Accessories	169
Connecting technology Cat.6 _A shielded	106	Subfloor systems	177

FIBRE OPTIC TECHNOLOGY

Product overview and selection guide for optical fibres	182	Product overview and selection guide for outdoor cables	219
Checklist: Fibre types, applications and maximum link lengths	183	Outdoor cables	220
Singlemode fibres	184	Trunks	242
Multimode fibres	189	Pigtails	246
Fibre optic cables - product overview	194	Patch cords	247
Product overview and selection guide for indoor and universal cables	196	Connectors	256
Indoor cables	197	Faceplates	259
Universal cables	206	Panels & enclosures	260
		Accessories	272

DATA CABINETS & RACKS

Data cabinets & racks	275
Cold aisle containment	281
Data cabinet & rack accessories	284

DATA CENTRE

Datwyler Data Centre Solution	289
-------------------------------	-----

WIRELESS

Wireless solutions	321
--------------------	-----

MULTIMEDIA

Multimedia solution	329
---------------------	-----

GENERAL INFORMATION

Copper technology	333
Fibre optic technology	344
Technical terms used in data cable technology	350
Index of article numbers	356

DELIVERING EXCELLENCE – EVERY TIME, EVERYWHERE

The “lifeblood” of a modern public or commercial building is the functionality and reliability of the system solutions for communications (data, voice, video/TV), fire safety and lifts. This is true of any such construction, irrespective of whether it is an office block, hotel, hospital, sports stadium, television studio or a tunnel. Choose a reliable system partner right from the start: choose Datwyler!



Hotels, hospitals

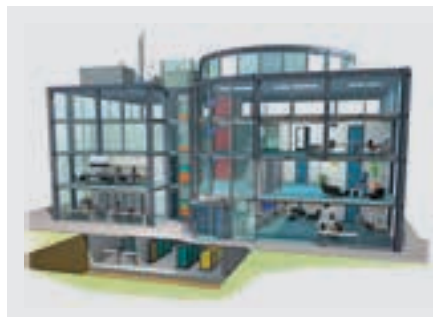

Office blocks

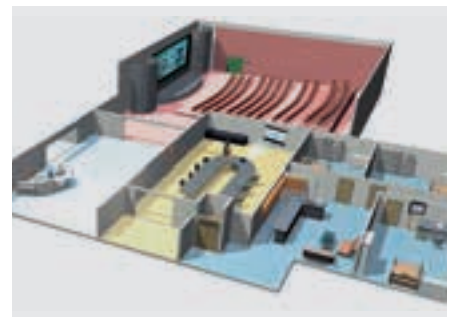

Government buildings, universities

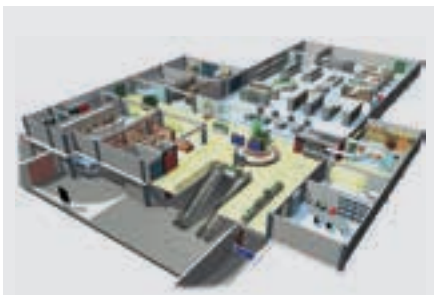

Shopping centres

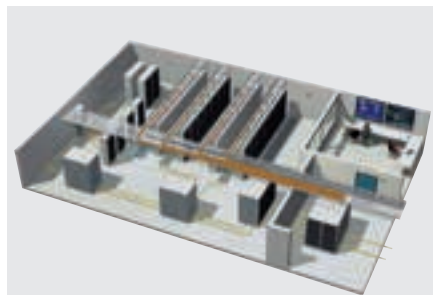

Data centres



Tunnels

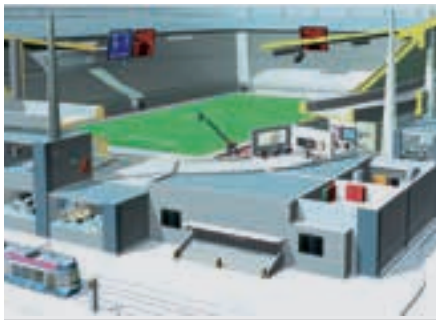

Event arenas



FTTx projects

Datwyler Cabling Solutions is an internationally operating supplier of premium-quality products, system solutions and services for electrical and communications infrastructures in public and commercial buildings and data centres as well as for Fibre to the home (FTTH) networks.

Being a well-established company which will shortly celebrate its centenary, Datwyler leads the way in innovations for applications such as ICT networks, fire safety, building automation and lifts.

Datwyler is a one-stop source of customised solutions for all your specific applications – with all the necessary test certificates, authorisations and approvals as well as long-term warranties.

Datwyler successfully operates in the market not only as a reliable supplier of innovative products and systems, but also provides – in close cooperation with experienced local partners – premium quality services for its customers: from site surveys, conception and system engineering through installation, logistics and turnkey supply to documentation and system maintenance.

TURNKEY INSTALLATIONS

Datwyler Cabling Solutions does not only supply integrated system solutions, but has positioned itself successfully as a complete solutions partner: for all manner of purpose-built constructions including multi-site projects, for data centres and for FTTx projects. Our successful processing of projects derives from our high-level skills in developing and manufacturing the required products and solutions, our comprehensive applications expertise, our international presence and our globally established partner network.

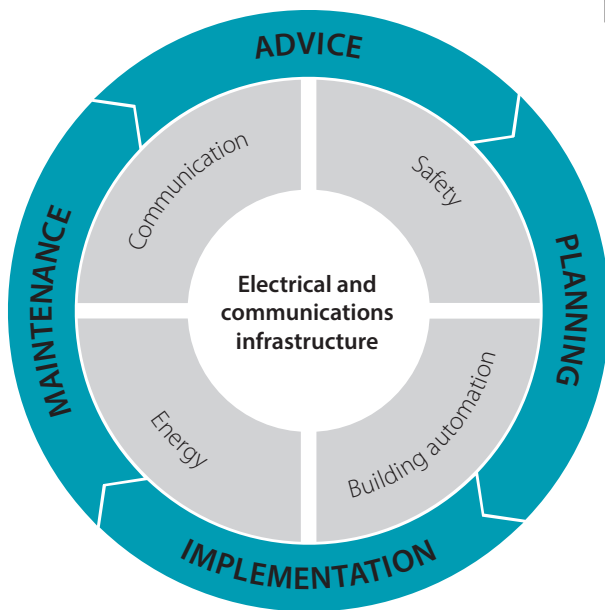

Our international presence and our worldwide, actively managed and certified partner network have also proved invaluable in the multi-site projects of major clients. National and international companies rely on Datwyler on-the-spot site audits. Using the site surveys as a base, our engineering experts work out customised solutions with uniform standards for all the sites concerned. Our total solutions package is rounded off by the implementation and assurance of regular operations. While operations are running, we provide servicing and maintenance work to optimise your infrastructure solution. These MAC (move, add, change) services increase the performance and working life of your equipment.

High-quality solutions for all your applications

Year on year, Datwyler invests in even better materials and process technologies, production resources and test methods. This is why our system solutions always keep ahead of the current standards and repeatedly set new standards. The important functions which our solutions must deliver in practice demand the highest possible level of safety and reliability.

This is why we measure each product against stringent quality standards before it leaves the company. Of course, all our processes are ISO 9001:2008 / ISO 14001:2004 certified.

Our sustainable solutions provide you with high-level operational reliability coupled with low operating costs. The proof that Datwyler systems can deliver these benefits has been evident for many years in thousands of installations around the world. In addition, we have a particularly keen eye for consistent, intelligent solutions that simplify planning, sourcing and installation and shorten your construction times.

We have the solutions for all your applications, whatever they are – high-speed communications networks, modern energy distribution, monitoring and control services, fire alarm systems or lift cabling. Or you may want to integrate new systems, interconnect and automate existing systems or simply ensure a reliable power supply. All this is possible with our carefully thought out, pre-assembled and prefabricated subsystems.

Just tell us how, when and where

Besides quality and product price, the logistics performance capability of suppliers is a decisive factor in the successful handling of construction projects. This is particularly true of major projects. With its years of experience and high logistics competences, Datwyler can handle even time-critical major projects smoothly and to the complete satisfaction of customers. Just-in-time deliveries at the right place are all in a day's work for us and our partners.



Besides delivering straight to the construction site, we also offer additional logistics services (time slots, pre-fitted and pre-assembled products etc.). Many customers and suppliers have a direct link to our IT system for rapid and flexible order processing.

As regards cable pre-assembly, Datwyler also has wide-ranging expertise, the product of decades of experience. In our modern cable cutting centre, the engineering department passes the cutting orders electronically without any media discontinuity straight to the production area. Our efficient order communication system with all our customers is due to years of experience with B2B interfaces.

In many countries Datwyler Cabling Solutions work in close co-operation with independent distribution partners. Thus, our customers can rely on the consistently high quality standard of all Datwyler products and solutions whilst benefiting from local contacts and logistics services.

We support you in realising your infrastructure project – reliably, capably, complete and with the highest quality!

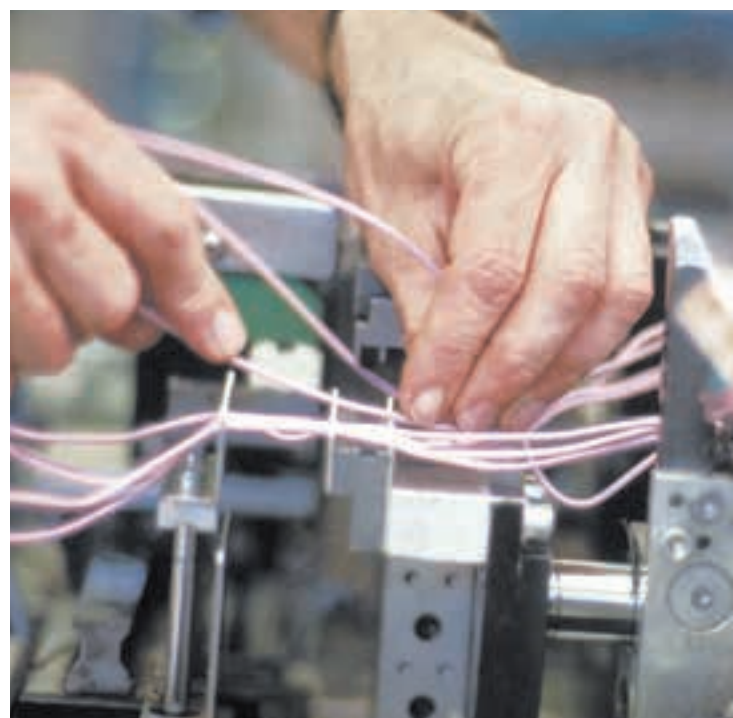

HIGHSPEED COMMUNICATION





From analogue telephony up to 10/40/100G; from Local Area Network and high-density Data Centre cabling to entire carrier and Fibre to the home networks – Datwyler is your preferred partner for top-quality, reliable and future-proof ICT networks in copper and fibre optics. With outstanding products and system solutions, Datwyler set standards for quality, performance and investment protection.



Media convergence in communications is an irreversible trend. IP technology merged media such as telephone, television and Internet. Multimedia is already reality.

However, technologies continue to develop, and the demand for ever increasing bandwidth continues to boom.

Future-proof networks thanks to high-quality solutions

With the constantly increasing transfer rates, requirements for cable systems are becoming more demanding. The high-quality solutions of Datwyler exploit the full potential of networks and offer high investment security for the future. The comprehensive product range extends from single cables and components to complete end-to-end systems.

Modular solutions for every application

Datwyler modular solutions are suitable for all sizes and types of networks – from residential cabling to cabling systems for offices or industrial buildings to campus, access, or carrier networks for thousands of users.

Telecom providers rely on our experience and know-how, as do banks, insurance companies, universities, hospitals, airports, car manufacturers and industrial companies.

SYSTEM SOLUTIONS FROM A SINGLE SOURCE



Leading know-how

As a provider of total solutions for information and telecommunication networks, Datwyler possesses extensive know-how accumulated over decades:

- Almost 100 years of experience in cable production
- Leading material, production and process know-how in the fabrication of copper and fibre-optic cables and components
- Solid electro-technical competency
- Close collaboration with renowned technical universities, international standards committees, and independent testing institutes
- Broad systems competence

Diverse applications

In the field of ICT networks Datwyler concentrates on communication infrastructures for public and commercial buildings and on FTTx networks.

Some examples are:

- Office, industrial and exhibition buildings
- Data centres
- Hotels and hospitals
- Stadiums, theatres, concert halls
- Airports and train stations
- FTTx projects of public utility companies and energy supply companies

In these market segments we can also flexibly meet individual customer requirements – up to and including turnkey and multi-site projects – with our cost-effective, modular system solutions and comprehensive services.

Complete system solutions

- Screened and unshielded copper system solutions (categories 3 to 8) for the transmission of voice, data, video, CATV, control signals and remote power (power over Ethernet, PoE+)
- Innovative fibre-optic system solutions with single-mode and multimode optical fibres for indoor and outdoor applications, from LAN backbones to FTTH in-house cabling
- Software solution for building, technology and network management
- Extensive services ranging from consulting and planning via pre-fabrication, logistics and installation to system maintenance.
- Established worldwide, actively managed and certified partner network
- Rigorous training and certification programme to guarantee optimal installation quality of our systems and solutions.
- Long-term warranty covering the entire system

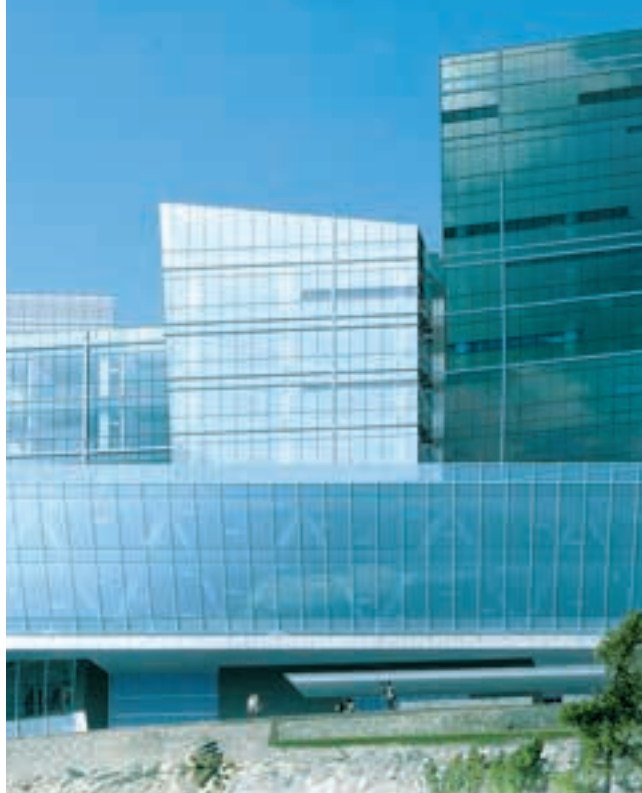

Yangshan Deepwater Port administration centre, Shanghai

Selected reference projects

The Squire - Airrail Center	Frankfurt a.M.	Rathbones	London
Party school campus	Hangzhou	Dubai Motor City	Dubai
Kunming Airport	Kunming	Swisscom IT Services	Zollikofen
UBI Banca (1,964 branch offices)	Bergamo	UBS central administration, Flurhof	Zurich
Swiss parliament building	Berne	Allianz Arena	Munich
Dexia BIL	Luxembourg	KPMG German headquarters	Berlin

Focus on customer value

Datwyler stands for more than just the fabrication and distribution of products. For your ICT networks we offer future-proof, modular, customised one-stop solutions for all your specific applications – as a uniquely attractive overall package, with all the necessary test certificates, authorizations and certificates and with long-term warranties.

The interaction of these elements creates added value. As a customer you benefit from maximum network availability and high investment protection, even with regard to future applications, expansions and changes.



Allianz Arena, Munich

PRODUCT OVERVIEW

Integrated, future-proof cabling solutions for ultimate reliability in voice, data, video and CATV applications

Performance beyond products

With the complete packages offered by Datwyler you are opting for comprehensive application-neutral and provider-independent system solutions encompassing the communication infrastructure for office and industry environments and for FTTx.

For Datwyler, quality testing and quality management begin during the cable production process. Here relevant electrical and mechanical data are recorded online and automatically compared with the predefined specifications. The performance values of our cables generally exceed current standards and standard drafts by considerable margin.

Datwyler follows the same procedure for the production of connection components such as data outlets, patch panels and patch cables for copper and fibre optic systems.

Labelling of individual components ensures that data measured up to the time of production can be called up at any point in the future. This gives end users a high degree of certainty that the products used and manufactured provide the durability demanded by them.



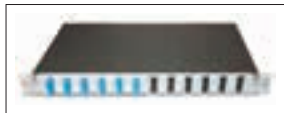

FO patch panel
OV-A

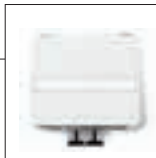

FO faceplates / data outlets



FO patch cords

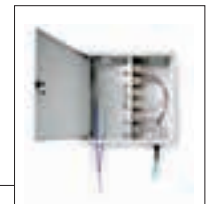

FO wall-mounted
distribution box
OV-W



FO Indoor cables



FO Universal cables
FO Safety cables

Copper data cables (solid) /
copper flexible cables



e.g.:
Cat.6 : CU 7060 4P
Cat.7: CU 7080 4P
better than Cat.7 :
CU 7150 4P

Multimedia CAT TV Balun,
active balun up to 862 MHz
for the distribution of CATV signals



Multimedia CAT TV Panel,
active distribution panel up to 862 MHz
for the distribution of CATV signals in LANs

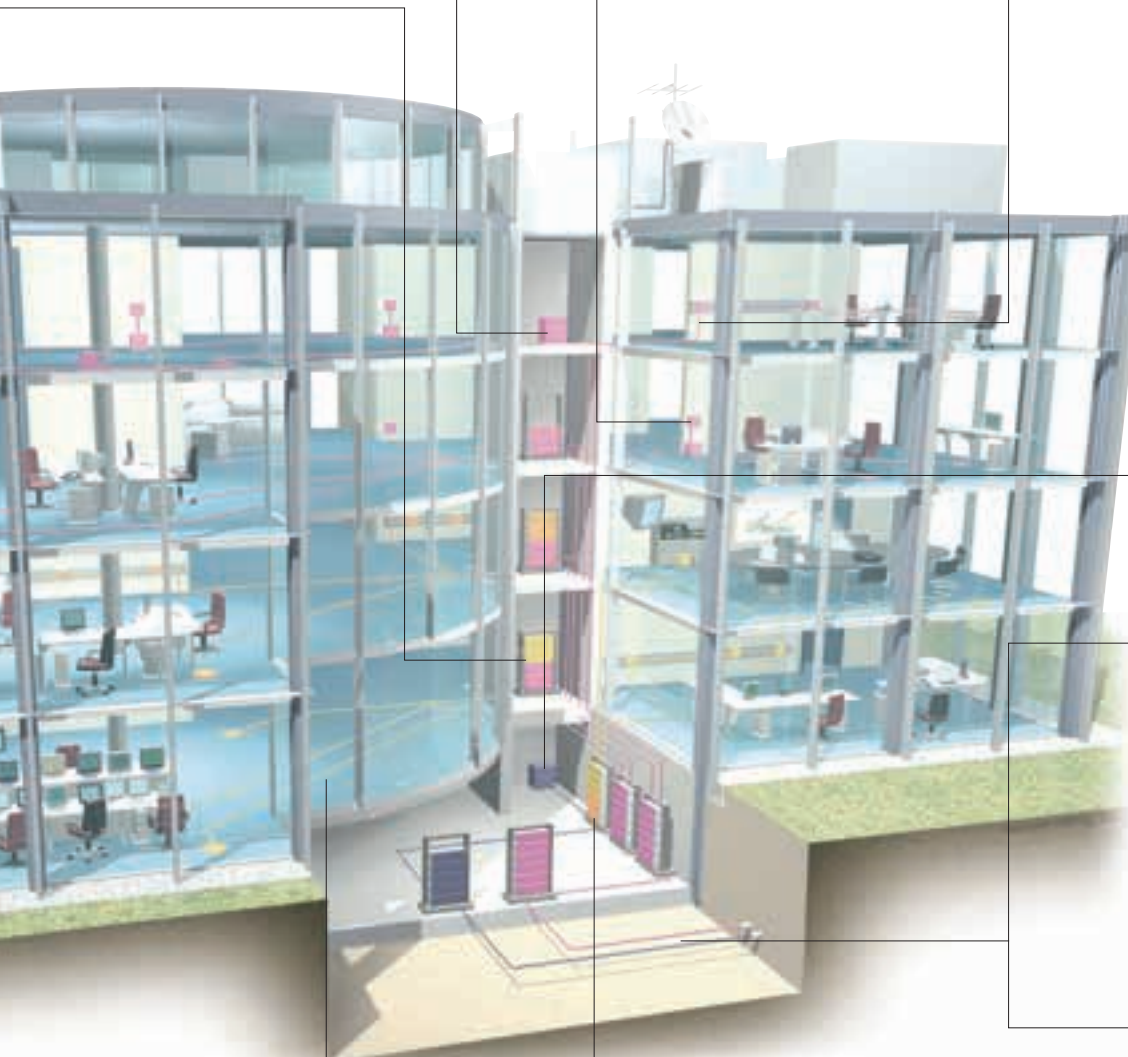

PRODUCT OVERVIEW

COPPER		FIBRE OPTICS	
Cables shielded / unshielded	Connectors shielded / unshielded	Cables	Connectors
Copper installation / flexible cables 	Copper modules 	Fibre optic indoor cables 	Fibre optic adapters and couplers 
Copper patch cords 	Copper patch panels 	Fibre optic universal and safety cables 	Fibre optic patch panels 
Copper multiple cables (trunks), highly flexible, pre-assembled 	Copper faceplates / data outlets 	Fibre optic patch and adapter cable 	Fibre optic faceplates / data outlets 
Copper multiple cable (trunk), highly flexible, pre-assembled 	Sub-floor / floor-box solutions 	Fibre optic multiple cable (trunk) 	Fibre optic wall mounted distribution boxes 
Measurement cables 	Accessories 	Fibre optic multiple cable (trunk) BreakOut 	Fibre optic accessories 

Are you looking for a building, technology and network management software which enables effective planning, management, documentation and control of all objects and processes around your infrastructure? Feel free to ask for details about "Panorama"!

RACK SYSTEMS	DATA CENTRE SOLUTIONS	WIRELESS SOLUTIONS	MULTIMEDIA
Network-/Server racks	FO-DCS High-Speed and High Density cabling system	WiFi Powerful Wireless Fidelity	Multimedia and switching
Network racks 	FO-DCS modular subrack 	WiFi Arrays 	CAT TV Panel active distribution panel up to 862 MHz for the distribution of CATV signals 
Server racks 	FO-DCS plug-in modules 	Transformers 	CAT TV Balun active balun up to 862 MHz for the distribution of CATV signals 
Wall mounted boxes 	FO-DCS MTP front panels 	Access points 	Network camera 
Miniracks 	FO-DCS fanout cables 	Management system 	Video monitoring system 
IT rack accessories 	FO-DCS mini breakout cables 	WiFi accessories 	Switches 

PRODUCT FEATURES

The following pictograms show the essential features of our products and give an easy reference.

They are allocated to the articles on the data sheets and provide you with a quick overview



Zero halogen, no corrosive gases

These Datwyler cables are halogen-free and reduce possible damage to health or material to a minimum.

IEC 60754-1 and IEC 60754-2,
EN 50267-2-1, EN 50267-2-2, EN 50267-2-3
VDE 0482-267 part 2-1, 2-2 and 2-3



Flame propagation

These Datwyler cables use a high-performance, flame retardant material that is self-extinguishing.

IEC 60332-1-2,
EN 60332-1-2,
VDE 0482-332-1-2



Flame spread

These Datwyler cables are flame resistant and prevent the propagation of a fire from one location to another

IEC 60332-3-22 to 25 cat. A-D,
EN 60332-3-22 bis 25 cat. A-D,
VDE 0482-332-3-22 to 25 cat. A-D



Smoke density

These Datwyler cables emit minimum smoke in the event of fire. Exit routes and fire brigade access are not restricted.

IEC 61034-1 and IEC 61034-2,
EN 61034-1 and EN 61034-2,
VDE 0482-1034 part 1 and 2



Circuit Integrity [FE/PH]

These Datwyler cables with circuit integrity guarantee the function of a single cable for a defined duration. (FE = flame time and influence time)

IEC 60331-1, IEC 60331-2 and part 21,23, 25,
EN 50200 with Annex E, EN 50362,
VDE 0472 part 814, VDE 0482-200,
VDE 0482-362,
BS 8434-2, BS 6387 (cat. C/W/Z)



System Circuit Integrity [E30-E90]

These Datwyler cables, together with certified Datwyler fixing systems, guarantee enhanced circuit integrity of the complete electrical cable installation for a defined time. (E30=30 minutes, E60=60 minutes, E90=90 minutes)

DIN 4102 part 12 (E30-E90)
NBN 713.020 (Rf1, Rf1½)



M

modular

Modular design of the connecting technology with changeable modules. Providing the possibility of faster maintenance and hassle-free alterations in the event of increased user demand.



EMV

shielded

Fully shielded faceplates/outlets, patch panels and data cables, ensuring the compliance with the EMC guidelines according to EN55022 and uninterrupted operation. The compatibility with other systems in the environment is guaranteed due to the excellent shielding of all cables and components.



**Power over Ethernet
PoE+ (IEEE 802.3at)**

30 W

for copper data cables with AWG 22



**Power over Ethernet
PoE+ (IEEE 802.3af)**

30 W

for copper data cables < AWG 22



**Power over Ethernet
PoE (IEEE 802.3af)**

15 W

for copper data cables



ROHS

Directive
2011/65/EU

of the European Parliament and of the Council of 8 June 2011 on the restriction of the use of certain hazardous substances in electrical and electronic equipment. (revised form)

THE MOST IMPORTANT TEST PROCEDURES AND THEIR FUNCTIONS

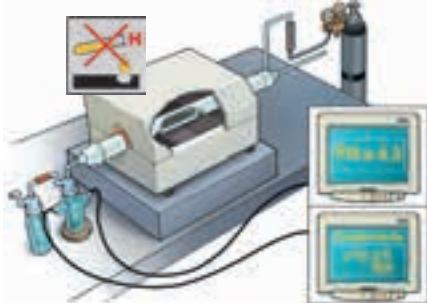

Test on gases evolved during combustion

This test procedure provides information if the insulation material of the cable sheath creates corrosive gases in the event of fire.

Halogen parts or other material in small quantities can be easily identified with this test due to the strong change of pH and conductivity. The conductivity is $< 10\text{mS/mm}$.

Standards

- IEC 60754-1 and IEC 60754-2
- EN 50267-2-1, EN 50267-2-2
- EN 50267-2-3
- VDE 0482-267 part 2-1, 2-2 and 2-3

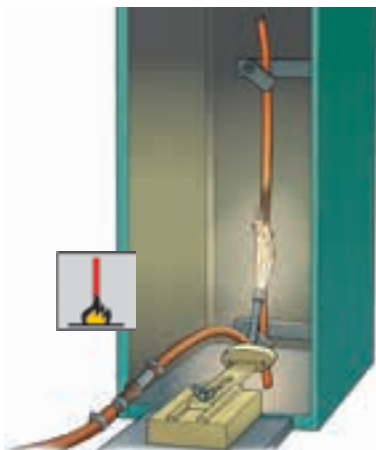

Test for vertical flame propagation (single insulated wire or single cable)

This test method tests a cable sample (length: 60 cm) for burning behaviour.

Standards

- IEC 60332-1-2
- EN 60332-1-2
- VDE 0482-332-1-2

The flame must extinguish itself, and the burn damage must not reach the upper end of the cable sample.

Test for vertical flame spread (bunched wires or cables)

This test method tests a cable bundle (length: 360 cm) with regard to fire propagation.

The flames must extinguish themselves, and burn damage must not exceed a defined height.

Standards

- IEC 60332-3-22 up to 25 Cat. A-D
- EN 60332-3-22 up to 25 Cat. A-D
- VDE 0482-332-3-22 up to 25 Cat. A-D

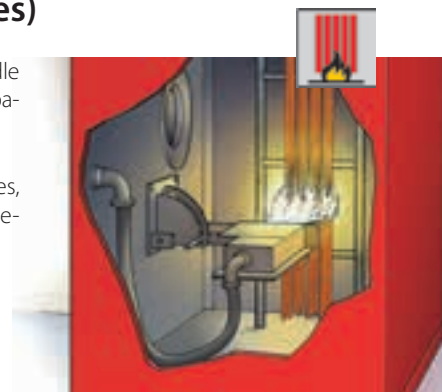

Measurement of smoke density

This test checks smoke development when burning the cable or the impairment of the visibility by burning cables.

The reduction in light transparency is measured in a standard chamber.

Standards

- IEC 61034-1 and IEC 61034-2
- EN 61034-1 and EN 61034-2
- VDE 0482-1034 part 1 and 2

THE MOST IMPORTANT TEST PROCEDURES AND THEIR FUNCTIONS

Test of Circuit Integrity (FE/PH)

This test establishes whether a single cable can maintain circuit integrity during and after exposure to a fire for a time period of at least 180 minutes. Cables that fulfil the requirements of this test are marked with "FE180" after their type designation.

There is no obligation to test the cable for Functional Integrity (System Circuit Integrity) beyond the designated period.

Remark:

This test is not equivalent to the test for Functional Integrity in accordance with DIN 4102-12

Test of Circuit Integrity (fire and water)

- BS 6387 (cat.W) [650°C, 3A]
- VdS 3423 [>830°C, 3A]
- EN 50200 Annex E [>830°C, 2A]

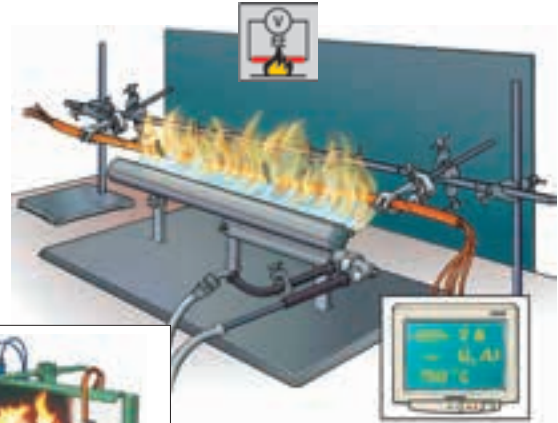

Test of Circuit Integrity (fire alone)

- IEC 60331-11/-21/-23/-25 [>750°C]
- BS 6387 (cat. C) [950°C]
- VDE 0472-814 [>750°C]

Test of Circuit Integrity (fire and mechanical shock)

- IEC 60331-1/-2 [>830°C, 2A]
- EN 50200 (PH) [>830°C, 2A]
- EN 50362 [> 830°C, 2A]
- BS 6387 (cat.Z) [950°C, 3A]

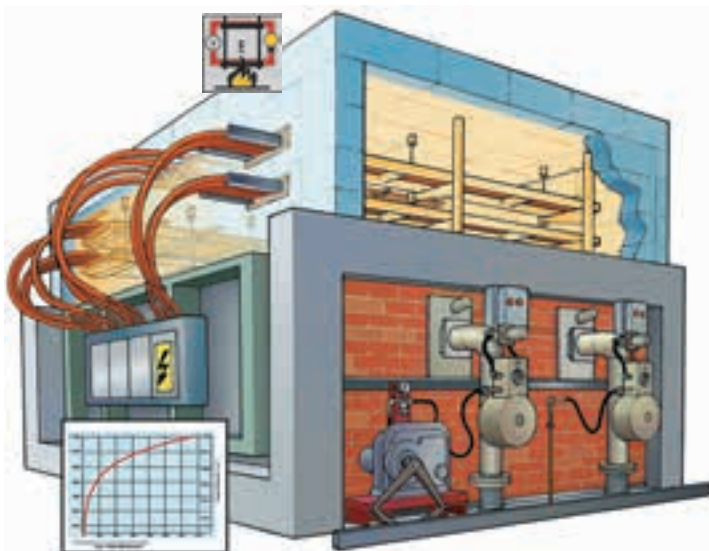

Test of Functional Integrity (E) of electrical cable installations

This standard describes the requirements and the actions to achieve enhanced circuit integrity of the complete electrical cable installation in the event of fire (System Circuit Integrity).

While the Circuit Integrity test (FE/PH) is only for single cables, in this test cables are tested together and in connection with practical fixing systems.

It is important to note that there is no connection between the two standards, Circuit Integrity (FE/PH) and enhanced or System Circuit Integrity (E).

The test is carried out and certified from state recognised institutes.

Standards

- DIN 4102 part 12 (E30-E90)
- NBN 713-020 (Rf1, Rf1½)

Better than the standard!

This test (E30-E90) is now the only worldwide standard for guaranteeing the Functional Integrity of the complete electrical cable installation, including the fixing components, under normal operating conditions.

THE MOST IMPORTANT TEST PROCEDURES AND THEIR FUNCTIONS

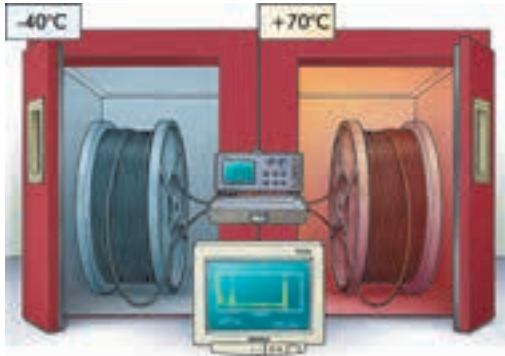

Temperature change and humidity

This test procedure checks the electrical parameters (LF and HF) of a data cable following temperature or humidity changes. Test conditions for the temperature and humidity dependent measurements must simulate the worst conditions.

Standard

- IEC 60794-1-2F1

Tensile performance

This test checks the behaviour of the electrical LF and HF parameters as a function of the pulling force of the data cable, such as that occurring during draw-in. This is not a destructive test.

This means that the cable is loaded with the maximum allowable pulling force.

Standard

- IEC 60794-1-2-E1B

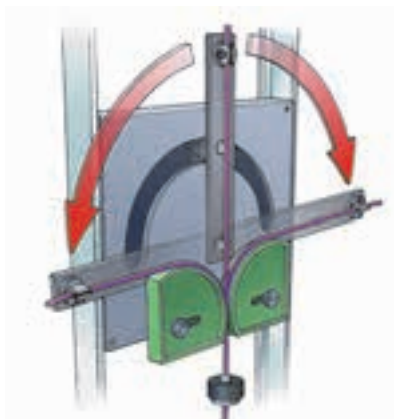
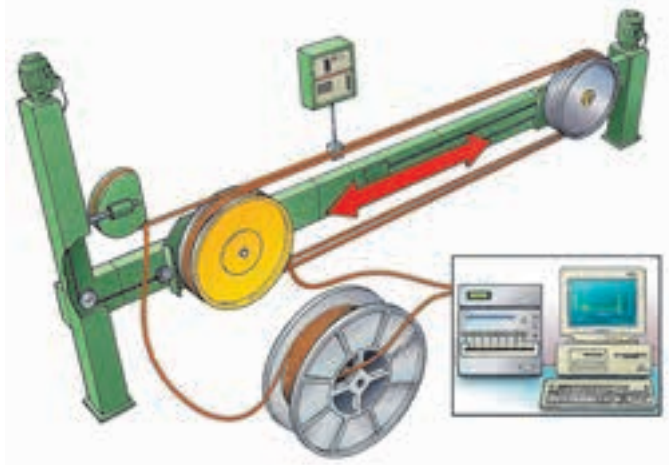

Repeated bending

The behaviour of a data cable is determined by bending a cable sample forwards and backwards 180 degrees several times. Afterwards, the cable must still fulfil the electrical LF and HF parameters according to the EN 50173 standard.

Standard

- IEC 60794-1-2-E6

Hammer blow

In order to determine the resistance of a data cable against impacts, a wedge is allowed to fall vertically onto the cable. Afterwards, the cable must still fulfil the electrical LF and HF parameters according to the EN 50173 standard.

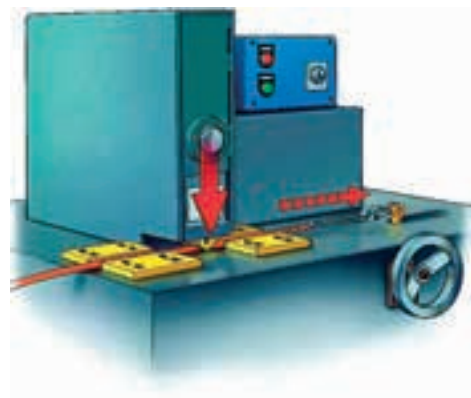

THE MOST IMPORTANT TEST PROCEDURES AND THEIR FUNCTIONS



Impact

The fall of a heavy tool, device, stone, etc. onto the cable is simulated here. The weight is allowed to fall vertically onto an intermediate steel piece that transmits the force to the cable sample. No damage to the cable sheath may occur.

Standard

- IEC 60794-1-2-E4

Crush resistance

The purpose of this test is to determine the ability of a data cable to withstand transverse pressure. After that, the electrical LF and HF parameters must still correspond to the EN 50173 standard.

Standard

- IEC 60794-1-2-E3

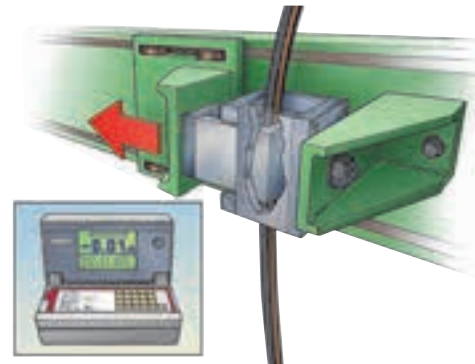

Torsion

During installation, a fibre optic cable must withstand torsion forces in addition to tension, transverse pressure and bending loads. Thus, a cable sample is turned about its own axis. Attenuation deviations are documented during the test. Neither fibre nor sheath materials may be damaged during the test.

Standard

- IEC 60794-1-2-E7

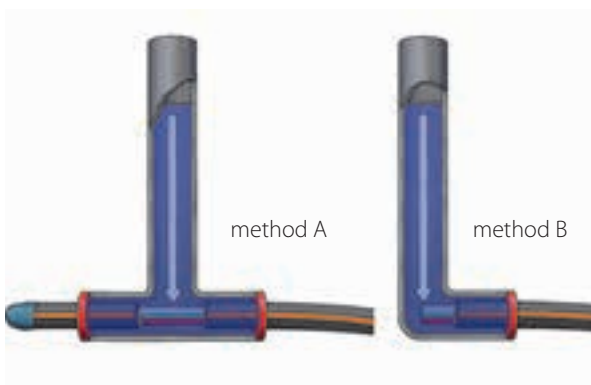
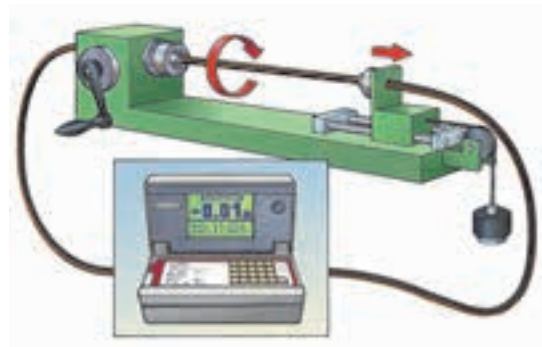

Water penetration

This method checks whether all interstices of a fibre optic outdoor cable are continuously filled with a compound that prevents water from entering the cable. Determining test criteria are the time and the maximum dispersal of the water within the sample. Datwyler uses the more demanding test method B exclusively.

Standard

- IEC 60794-1-2-F5-A/B

ROHS – WEEE – REACH

Statement from Datwyler Cabling Solutions:

As an environmentally conscious manufacturer and supplier of cabling solutions it is our concern not to use any environmentally harmful substances in our products.

Based on current information, the herein-mentioned guidelines / regulations for banned substances are fully complied with. Exceptions are noted as such on the respective data sheet.



ROHS

DIRECTIVE 2011/65/EU
OF THE EUROPEAN PARLIAMENT AND
OF THE COUNCIL
of 8 June 2011
on the restriction of the use of certain hazardous
substances in electrical and electronic equipment
(recast)

WEEE

DIRECTIVE 2012/19/EU
OF THE EUROPEAN PARLIAMENT AND
OF THE COUNCIL
of 4 July 2012
on waste electrical and electronic equipment (WEEE)
(recast)

REACH

REGULATION (EC) No 1907/2006
OF THE EUROPEAN PARLIAMENT AND OF THE COUNCIL
of 18 December 2006
concerning the Registration, Evaluation, Authorisation
and Restriction of Chemicals (**REACH**), establishing
a European Chemicals Agency, amending Directive
1999/45/EC and repealing Council Regulation (EEC)
No 793/93 and Commission Regulation (EC) No
1488/94 as well as Council Directive 76/769/EEC Com-
mission Directives 91/155/EEC, 93/67/EEC, 93/105/EC
and 200/21/EC

and

COMMISSION REGULATION (EU) No 143/2011
of 17 February 2011
amending Annex XIV to Regulation (EC) No 1907/2006
of the European Parliament and of the Council on the
Registration, Evaluation, Authorisation and Restriction
of Chemicals.

Product overview and selection guide for copper data cables

Selection criteria

The Datwyler product portfolio consists of many different cable types.

The following overview lists some of the more important criteria which will help you to decide for the cable types that meet your specific requirements.

page	cable type	Cable design	AWG = American Wire Gauge	Category / Class	Telephone, ISDN	Video signals (RGB); symmetrical transmission	Ethernet 10 BaseT / 100 BaseT	Gigabit-Ethernet 1000 BaseT	10-Gigabit Ethernet	40-Gigabit Ethernet up to 30 m	Cable Sharing	Suitable for horizontal cabling	Suitable for backbone and vertical/riser cabling	Suitable for patch / connecting cables	PimF (Pair in metal Foil)	Bundle cable	Stabilizing element (intermediate sheath for mech. stabilization)	PVC cable sheath (FR/PVC)	Halogen-free cable sheath (FRNC/LS0H)	Multimedia according to EN 50083-8	Stabilising element (Cross)	Suitable for outdoor use	Suitable for industrial applications
shielded																							
26	CU 8203 4P	S/FTP	23	8.2/II <small>(2000 MHz)</small>	•	•	•	•	•	•	•	•	•	•	•								
28	CU 7150 4P Multimedia / 2x4P F8 Multimedia	S/FTP	22	7 _A /F _A <small>(1000 MHz)</small>	•	•	•	•	•		•	•	•	•	•			•	•				
30	CU 7702 4P / 2x4P F8	S/FTP	22	7 _A /F _A <small>(1000 MHz)</small>	•	•	•	•	•		•	•	•	•	•			•	•				
32	CU 7120 4P / 2x4P F8	S/FTP	23	7 _A /F _A <small>(1000 MHz)</small>	•	•	•	•	•		•	•	•	•	•			•	•				
34	CU 7080 4P / 2x4P F8	S/FTP	23	7/F <small>(600 MHz)</small>	•	•	•	•	•		•	•	•	•	•			•	•				
36	CU 7002 4P / 2x4P F8	S/FTP	23	7/F <small>(600 MHz)</small>	•	•	•	•	•		•	•	•	•	•			•	•				
38	CU 7002 nx4P Breakout Light (BOL)	S/FTP	23	7/F <small>(600 MHz)</small>	•	•	•	•	•		•	•	•	•	•	•		•	•				
40	CU 7002 4P Industrial PUR	S/FTP	23	7/F <small>(600 MHz)</small>	•	•	•	•	•		•	•	•	•	•			•	•			•	
42	CU 7002 4P GG-PE	S/FTP	23	7/F <small>(600 MHz)</small>	•	•	•	•	•		•	•	•	•	•			•	•		•		
44	CU 7052 4P / 2x4P F8	F/FTP	23	7/F <small>(600 MHz)</small>	•	•	•	•	•		•	•	•	•	•			•	•				
46	CU 7060 4P / 2x4P F8	S/FTP	23	6 _A /E _A <small>(500 MHz)</small>	•	•	•	•	•		•	•	•	•	•			•	•				
48	CU 6552 4P	F/FTP	23	6 _A /E _A <small>(500 MHz)</small>	•	•	•	•	•		•	•	•	•	•			•	•				
50	CU 6502 4P	U/FTP	23	6 _A /E _A <small>(500 MHz)</small>	•	•	•	•	•		•	•	•	•	•			•	•				
52	CU 6052 4P / 2x4P F8	F/FTP	23	6/E <small>(250 MHz)</small>	•	•	•	•	•		•	•	•	•	•			•	•				
54	CU 6702 4P	SF/UTP	24	6/E <small>(250 MHz)</small>	•	•	•	•	•		•	•	•	•	•	•		•	•				
56	CU 6002 4P	U/FTP	23	6/E <small>(250 MHz)</small>	•	•	•	•	•		•	•	•	•	•			•	•				
58	CU 5502 4P	SF/UTP	24	5e/D <small>(100 MHz)</small>	•	•	•	•	•		•	•	•	•	•			•	•				
60	CU 5002 4P	F/UTP	24	5e/D <small>(100 MHz)</small>	•	•	•	•	•		•	•	•	•	•			•	•				
62	CU 8206 4P flex	S/FTP	26	8.2/II <small>(2000 MHz)</small>	•	•	•	•	•	•	•	•	•	•	•			•	•				
64	CU 7150 4P flex	S/FTP	26	7 _A /F _A <small>(1000 MHz)</small>	•	•	•	•	•		•	•	•	•	•			•	•				
66	CU 7702 4P flex	S/FTP	26	7/F <small>(600 MHz)</small>	•	•	•	•	•		•	•	•	•	•			•	•				
68	CU 7702 4P flex Industrial PUR	S/FTP	26	7/F <small>(600 MHz)</small>	•	•	•	•	•		•	•	•	•	•			•	•			•	
70	CU 1P flex Multimedia	S/FTP	26	7/F <small>(600 MHz)</small>	•	•	•	•	•		•	•	•	•	•			•	•				
72	CU 2P flex Multimedia	S/FTP	26	7/F <small>(600 MHz)</small>	•	•	•	•	•		•	•	•	•	•			•	•				
74	CU 5502 4P flex	S/UTP	26	5e/D <small>(100 MHz)</small>	•	•	•	•	•		•	•	•	•	•			•	•				
unshielded																							
76	CU 662 4P	U/UTP	24	6/E <small>(250 MHz)</small>	•	•	•	•	•		•	•	•	•	•			•	•		•		
78	CU 502 4P	U/UTP	24	5e/D <small>(100 MHz)</small>	•	•	•	•	•		•	•	•	•	•			•	•				
80	CU 602 4P flex	U/UTP	24	6/E <small>(250 MHz)</small>	•	•	•	•	•		•	•	•	•	•			•	•				
telephone cable																							
82	DATWYLER 25-pair Indoor	U/UTP	24	3/C <small>(16 MHz)</small>	•							•	•					•	•				
84	DATWYLER 50-pair Indoor	U/UTP	24	3/C <small>(16 MHz)</small>	•							•	•					•	•				
86	DATWYLER 100-pair Indoor	U/UTP	24	3/C <small>(16 MHz)</small>	•							•	•					•	•				

COPPER

**At a glance guide:
Copper data cables, by Category**

CATEGORY / CLASS

8.2/II
(2000 MHz)

7_A/F_A
(1000 MHz)

7/F
(600 MHz)

6_A/E_A
(500 MHz)

6/E
(250 MHz)

5e/D
(100 MHz)
1000Base-T / 100Base-T

DATA CABLE shielded



CU 8203 4P



CU 7150 4P Multimedia / 2x4P F8 Multimedia



CU 7120 4P / 2x4P F8



CU 7702 4P / 2x4P F8



CU 7080 4P / 2x4P F8



CU 7002 4P Industrial PUR



CU 7002 4P / 2x4P F8



CU 7002 4P GG-PE

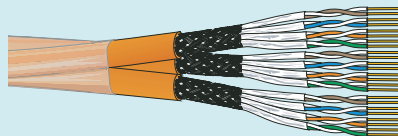

CU 7002 nx4P Breakout Light (BOL)



CU 7052 4P / 2x4P F8



CU 7060 4P / 2x4P F8



CU 6552 4P



CU 6502 4P

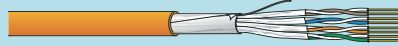

CU 6052 4P / 2x4P F8



CU 6702 4P



CU 6002 4P



CU 5502 4P



CU 5002 4P

Copper

Fibre Optics

Cabinets & Racks Optics

Cabinets & Rack Data Centre

Data Wireless

Multimedia Wireless

Multimedia

General Information

Cables with higher category fulfil all requirements of the categories below.

FLEXIBLE CABLE shielded



CU 8206 4P flex



CU 7150 4P flex



CU 7702 4P flex



CU 7702 4P flex Industrial PUR



CU 1P flex Multimedia



CU 2P flex Multimedia

DATA CABLE unshielded

FLEXIBLE CABLE unshielded

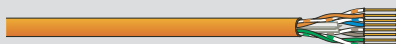

CU 662 4P

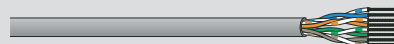

CU 602 4P flex



CU 5502 4P flex

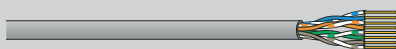

CU 502 4P

Copper

Fibre Optics

Cabinets & Racks

Data Centre















Wireless

Multimedia

General Information

**At a glance guide:
Copper connecting hardware, by Category**

CATEGORY / CLASS
<p>7_A/F_A (1000 MHz)</p> <hr/>
<p>7/F (600 MHz)</p> <hr/>
<p>6_A/E_A (500 MHz)</p> <hr/> <p>10GBase-T*</p> <p>*) In case of using these modules for 10GBase-T (Class E_A) applications we recommend Cat.7 or Cat.7_A data cables</p>
<p>6/E_A (500 MHz)</p> <hr/>
<p>6/E (250 MHz)</p> <hr/>
<p>5e/D (100 MHz)</p> <hr/> <p>1000Base-T / 100Base-T</p>

COPPER CONNECTING HARDWARE shielded
  <p>Module PS-GG45 7_A Module PS-TERA 4P Cat.7_A</p>
<p>The Cat.7 connecting hardware was optimized for the Cat.7_A requirements.</p>
    <p>RJ45 module KS-T Plus 1/8 toolless Cat.6_A (IEC) RJ45 module MS-K Plus 1/8 Cat.6_A RJ45 module MS-C6_A 1/8 Cat.6_A (IEC) 180° RJ45 module MS-C6_A 1/8 Cat.6_A (IEC) 180° - K (Keystone)</p>
    <p>RJ45 module KS-T 1/8 toolless Cat.6/E_A RJ45 module KS-TS 1/8 toolless slimline Cat.6/E_A RJ45 module MS 1/8 Cat.6/E_A RJ45 module KS-TA 1/8 45 degree angled, Cat.6/E_A</p>
   <p>Patch panel CSP 24/8 Cat.6 RJ45 Keystone coupler (RJ45-RJ45), 180°, straight RJ45 feed-trough coupler MS/KS, angled</p>
 <p>RJ45 module KS-T 5 1/8 toolless Cat.5e</p>

Please find an up-to-date matrix showing which patch panels and outlets are suitable for the insertion of the respective Datwyler module in the Support/Downloads section of our website www.cablng.datwyler.com.

Subject to technical modification.

Modules with a higher category implement all requirements of the category below.

COPPER CONNECTING HARDWARE unshielded



UP/K data outlet
CSA Plus 2/8 Cat.6_A

UP/K data outlet
CSA Plus 1/8 Cat.6_A



Patch panel CSA Plus 24/8 Cat.6_A (IEC)

Please note:

These modules also fulfil all Class E_A Channel requirements when connected to Cat.7 oder Cat.7_A data cables.



RJ45 feed-through coupler
MS/KS, straight



RJ45 module KU-T 1/8
toolless Cat.6



Patch panel CUP 24/8
Cat.6



RJ45 module KU-T 1/8
toolless Cat.5e

Data cable, S/FTP, Category 8.2, AWG23

CU 8203 4P

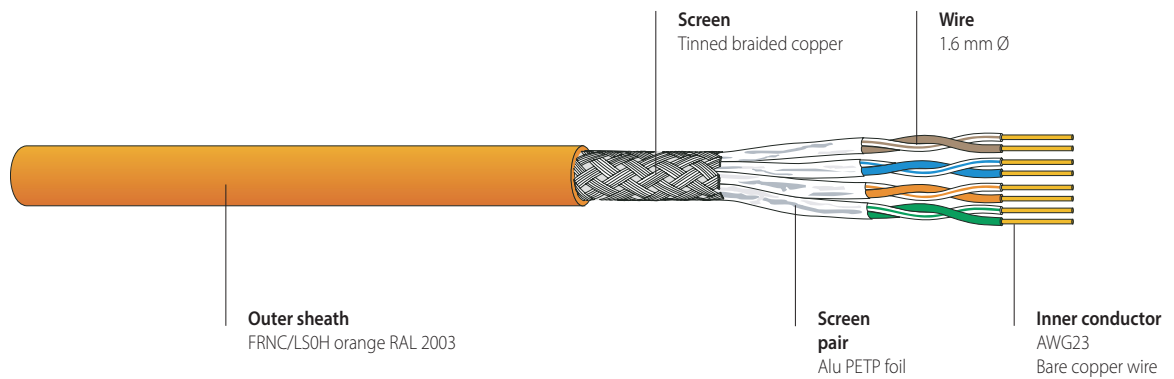

PRODUCT INFORMATION

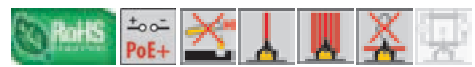

FEATURES

Electrically and mechanically high-quality Category 8.2 data cable – exceeds the requirements of ISO/IEC 11801, IEC 61156-5, EN 50173-1, EN 50288-9-1 and IEC 46C/1001/CD (draft). Excellent shielding effect due to individually screened pairs and overall copper braid. Compact cable design. Compatible with all current connecting hardware in accordance with EN 50173 and ISO/IEC 11801.

APPLICATIONS

High-end data cable for data centres. Developed particularly for 40 GBase-T transmission with maximum channel length of 30 metres in End of Row or Top of Rack (EoR / ToR) applications in data centres. For the transmission of digital and analogue voice, video and data signals. Suitable for all ICT network applications up to 2000 MHz. Applicable for Power over Ethernet (PoE / PoE+).

VERSIONS

Article No.	Dimension n x n x mm (AWG)	Sheath	Sheath Ø mm	Weight kg/km	Cu weight kg/km	Fire load kWh/m MJ/m	PU
192009	4 x 2 x 0,59 (AWG23)	FRNC/LSOH ¹⁾	8,1	67,3	33,2	0,18 0,649	1000 m drum

¹⁾ FRNC/LSOH = Flame Retardant Non Corrosive / Low Smoke Zero Halogen

ELECTRICAL CHARACTERISTICS

CATEGORY			5e	6	6 _A	7	CATV	7 _A	8.2		
Frequency [MHz]	1	4	10	100	250	500	600	862	1000	1600	2000
Attenuation [dB/30m]	0.54	0.95	1.5	5.0	8.0	11.3	12.5	15.6	16.3	21.0	23.5
NEXT [dB]	103	103	103	103	97	95	94	92	90	85	80
PS NEXT [dB]	100	100	100	100	94	92	91	89	77	82	77
ACR-N [dB]	102	102	101	98	89	84	80	77	74	64	56
PS-ACR-N [dB]	99	99	99	95	86	81	77	74	71	61	53
ACR-F [dB]	100	100	100	95	92	89	87	80	78	72	70
PS-ACR-F [dB]	97	97	97	92	89	86	84	77	75	69	67
Return loss [dB]	28	30	30	30	28	26	25	24	23	20	18

These performance data are typical measured values.

Loop resistance at 20° C: 135 Ω/km
 Mutual capacitance: 44 pF/m
 Impedance at 100 MHz: 100 Ω ±5 Ω
 Transfer impedance at 1/10/30 MHz: < 8/10/40 mΩ/m
 Coupling attenuation (limit curve of critical state - IEC 61156): > 75 dB
 Near end unbalance attenuation LCL at 1-600 MHz: > 20 dB
 Delay skew: 10 ns/100 m
 NVP: 75 %

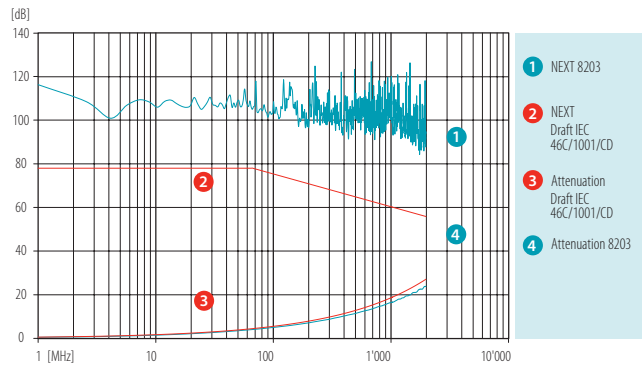

MECHANICAL CHARACTERISTICS

Bending radius (flat side)
 Tensile strength:
 Crush resistance:
 Impact resistance:
 Temperature range

during draw-in: ≥ 64 mm
 permanently installed: ≥ 32 mm ≤ 110 N
 ≥ 1000 N/10 cm
 ≥ 3 impacts
 during installation: 0 °C to +50 °C
 in operation: -20 °C to +60 °C

CU 8203 4P

GENERAL CHARACTERISTICS

Wire colour code

white-blue / blue
 white-orange / orange
 white-green / green
 white-brown / brown
 according to IEC 60189 and IEC 60708

Imprint

DATWYLER «cable type» «additional text» «batch number» «meter marks»

- Zero halogen, non corrosive gases
- Flame propagation
- Flame spread
- Smoke density
- Power over Ethernet plus
- EMC
- Cat.

IEC 60754-1/-2, EN 50267-2-1/-2-2 (VDE 0482-267-2-1/-2-2)
 IEC 60332-1-2, EN 60332-1-2 (VDE 0482-332-1-2)
 IEC 60332-3-24, EN 60332-3-24
 IEC 61034-1/-2, EN 61034-1/-2 (VDE 0482-1034-1/-2)
 IEEE 802.3at
 shielded
 Cat.8.2
 (IEC 46C/1001/CD, draft, for channel length of 30 m)

Data cable, S/FTP, Category 7_A, AWG22

CU 7150 4P Multimedia / 2x4P F8

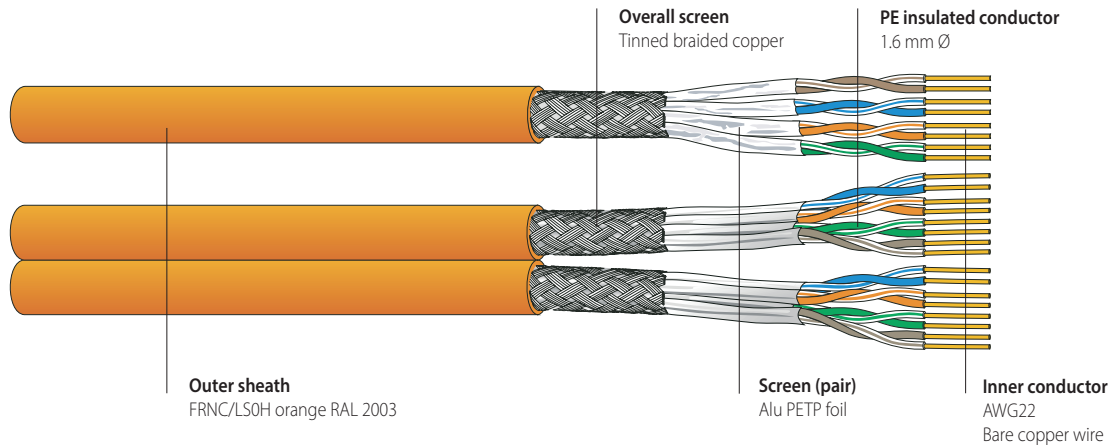

PRODUCT INFORMATION

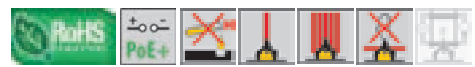

FEATURES

Electrically and mechanically high-quality Cat.7_A data cable - exceeds the requirements of ISO/IEC 11801, IEC 61156-5, IEC 61156-7, EN 50173-1 and prEN 50288-9-1.
 Excellent shielding effect due to individually screened pairs and overall copper braid.
 Easy identification of wires thanks to longitudinal colour markings.
 Compatible with all current connecting hardware in accordance with EN 50173 and ISO/IEC 11801.

APPLICATIONS

Data cable for structured premises cabling.
 For the transmission of digital and analogue voice, video and data signals.
 Suitable for all ICT network applications up to class F_A applications (1000 MHz) in accordance with EN 50173-1 and ISO/IEC 11801.
 Optimized for the transmission of broadband signals (such as cable TV) in accordance with IEC 15018.
 Due to the increased wire section eminently suited for Power over Ethernet (PoE) / PoE+.

VERSIONS

Article No.	Dimension n x n x mm (AWG)	Sheath	Sheath Ø mm	Weight kg/km	Cu weight kg/km	Fire load		PU
						kWh/m	MJ/m	
182925	4 x 2 x 0.64 (AWG22)	FRNC/LSOH ¹⁾	7.8	69.2	40.2	0.18	0.65	1000 m drum
182926	2 x (4 x 2 x 0.64 (AWG22))	FRNC/LSOH ¹⁾	7.8 x 16.4	139.2	80.4	0.36	1.30	500 m drum

¹⁾ FRNC/LSOH = Flame Retardant Non Corrosive / Low Smoke Zero Halogen

ELECTRICAL CHARACTERISTICS

CATEGORY			5e	6	6 _A	7	CATV	7 _A	61156-7		
Frequency [MHz]	1	4	10	100	250	500	600	862	1000	1200	1500
Attenuation [dB/100 m]	1.7	3.2	4.9	16.2	26	38	40	49	54	58	68
NEXT [dB]	103	103	103	103	103	98	96	92	90	85	80
PS NEXT [dB]	100	100	100	100	100	95	93	89	87	82	77
ACR-N [dB]	101	100	98	87	77	60	56	43	36	27	12
PS-ACR-N [dB]	98	97	95	84	74	57	53	40	33	24	9
ACR-F [dB]	110	108	106	94	84	71	66	58	55	46	41
PS-ACR-F [dB]	107	105	103	91	81	68	63	55	52	43	38
Return loss [dB]	26	30	33	33	28	26	25	24	23	23	20

These performance data are typical measured values.

Loop resistance at 20° C: 111 Ω/km
 Mutual capacitance: 41 pF/m
 Impedance at 100 MHz: 100 Ω ± 5 Ω
 Transfer impedance at 1/10/30 MHz: < 5/5/8 mΩ/m
 Coupling attenuation (limit curve of critical state - IEC 61156): > 85 dB
 Near end unbalance attenuation LCL at 1-600 MHz: > 40dB
 Delay skew: 17 ns/100m
 NVP: 80 %

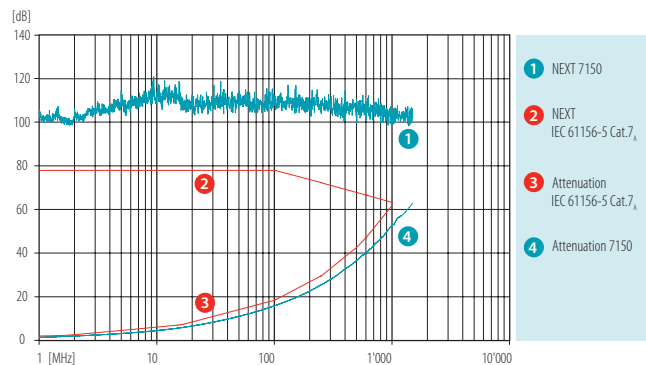

MECHANICAL CHARACTERISTICS

Bending radius (flat side)
 Tensile strength:
 Crush resistance:
 Impact resistance:
 Temperature range

during draw-in:
 permanently installed:
 during installation:
 in operation:

CU 7150 4P

≥ 64 mm
 ≥ 32 mm
 ≤ 130 N
 ≥ 1000 N/10 cm
 ≥ 10 impacts
 0° C to + 50° C
 -20° C to + 60° C

CU 7150 2x4P F8

≥ 64 mm
 ≥ 32 mm
 ≤ 260 N
 ≥ 1000 N/10 cm
 ≥ 10 impacts
 0° C to + 50° C
 -20° C to + 60° C

GENERAL CHARACTERISTICS

Wire colour code

white-blue/blue
 white-orange/orange
 white-green/green
 white-brown/brown
 (with longitudinal stripes)
 in accordance with IEC 60189 and IEC 60708

Imprint

DATWYLER «cable type» «additional text» «batch number» «meter marks»

- Zero halogen
- non corrosive gases
- Flame propagation
- Flame spread
- Smoke density
- Power over Ethernet plus
- EMC
- Segregation class
- Cat./Class

IEC 60754-1/-2, EN 50267-2-1/-2-2 (VDE 0482-267-2-1/-2-2)
 IEC 60332-1-2, EN 60332-1-2 (VDE 0482-332-1-2)
 IEC 60332-3-24, EN 60332-3-24
 IEC 61034-1/-2, EN 61034-1/-2 (VDE 0482-1034-1/-2)
 IEEE 802.3at
 shielded
 d
 Cat 7_A / Class F_A - limit values as specified by IEC 61156-5,
 IEC 61156-7 and EN 50288-9-1 guaranteed

COPPER DATA CABLES, SHIELDED

Data cable, S/FTP, Category 7_A, AWG22

CU 7702 4P / 2x4P F8

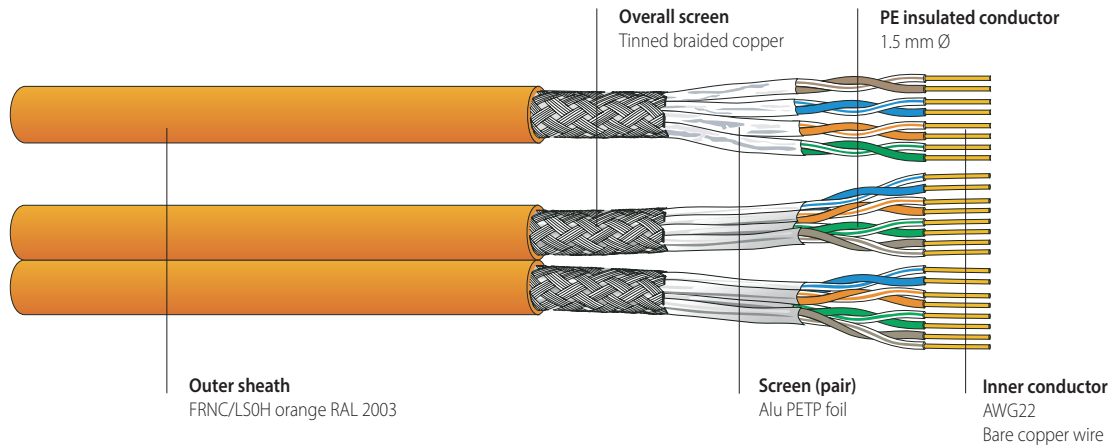

PRODUCT INFORMATION

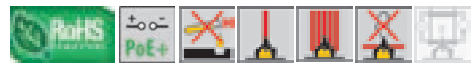

FEATURES

Electrically and mechanically high-quality Cat.7_A data cable - exceeds the requirements of ISO/IEC 11801, IEC 61156-5, IEC 61156-7, EN 50173-1 and prEN 50288-9-1. Excellent shielding effect due to individually screened pairs and overall copper braid. Easy identification of wires thanks to longitudinal colour markings. Compatible with all current connecting hardware in accordance with EN 50173 and ISO/IEC 11801.

APPLICATIONS

Data cable for structured premises cabling. For the transmission of digital and analogue voice, video and data signals. Suitable for all ICT network applications up to class F_A applications (1000 MHz) in accordance with EN 50173-1 and ISO/IEC 11801 and for the transmission of broadband signals (such as cable TV) in accordance with IEC 15018. Due to the increased wire section eminently suited for Power over Ethernet (PoE) / PoE+.

VERSIONS

Article No.	Dimension n x n x mm (AWG)	Sheath	Sheath Ø mm	Weight kg/km	Cu weight kg/km	Fire load		PU
						kWh/m	MJ/m	
177400	4 x 2 x 0.62 (AWG22)	FRNC/LSOH ¹⁾	7.8	65.1	34.9	0.18	0.65	1000 m drum
177390	2 x (4 x 2 x 0.62 (AWG22))	FRNC/LSOH ¹⁾	7.8 x 16.4	131.0	69.8	0.36	1.30	500 m drum

¹⁾ FRNC/LSOH = Flame Retardant Non Corrosive / Low Smoke Zero Halogen

Copper

Fibre Optics

Cabinets & Racks

Data Centre

Wireless

Multimedia

General Information

CU 7702 4P/2x4P 01714/e

ELECTRICAL CHARACTERISTICS

CATEGORY			5e	6	6 _A	7	CATV	7 _A		
Frequency [MHz]	1	4	10	100	250	500	600	862	1000	1200
Attenuation [dB/100m]	1.7	3.4	5.3	16.9	27	40	42	53	56	62
NEXT [dB]	103	103	103	103	103	98	96	92	90	85
PS NEXT [dB]	100	100	100	100	100	95	93	89	87	82
ACR-N [dB]	101	100	98	86	76	58	54	39	34	23
PS-ACR-N [dB]	98	97	95	83	73	55	51	36	31	20
ACR-F [dB]	109	107	105	93	83	70	65	57	54	46
PS-ACR-F [dB]	106	104	102	90	80	67	62	54	51	43
Return loss [dB]	26	30	33	33	28	26	25	24	23	21

These performance data are typical measured values.

Loop resistance at 20° C: 116 Ω/km
 Mutual capacitance 43 pF/m
 Impedance at 100 MHz: 100 Ω ± 5 Ω
 Transfer impedance at 1/10/30 MHz: < 5/5/8 mΩ/m
 Coupling attenuation (limit curve of critical state - IEC 61156): > 85 dB
 Near end unbalance attenuation LCL at 1-600 MHz: > 40 dB
 Delay skew: 15 ns/100m
 NVP: 76 %

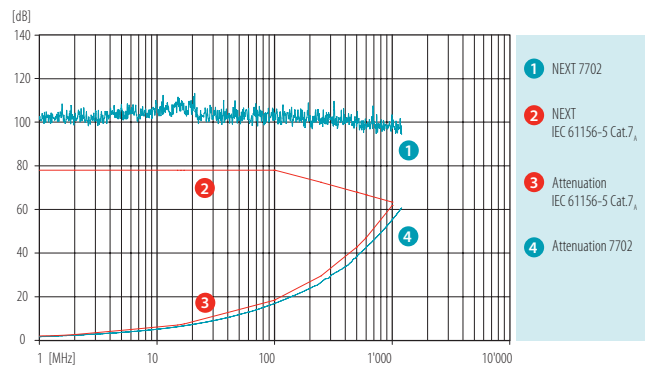

MECHANICAL CHARACTERISTICS

Bending radius (flat side)
 Tensile strength:
 Crush resistance:
 Impact:
 Temperature range

during draw-in:
 permanently installed:
 during installation:
 in operation:

CU 7702 4P

≥ 64 mm
 ≥ 32 mm
 ≤ 120 N
 ≥ 1000 N/10 cm
 ≥ 10 impacts
 0° C to + 50° C
 -20° C to + 60° C

CU 7702 2x4P F8

≥ 64 mm
 ≥ 32 mm
 ≤ 240 N
 ≥ 1000 N/10 cm
 ≥ 10 impacts
 0° C to + 50° C
 -20° C to + 60° C

GENERAL CHARACTERISTICS

Wire colour code

white-blue/blue
 white-orange/orange
 white-green/green
 white-brown/brown
 (with longitudinal stripes)
 in accordance with IEC 60189 and IEC 60708

Imprint

DATWYLER «cable type» «additional text» «batch number» «meter marks»

- Zero halogen
- non corrosive gases
- Flame propagation
- Flame spread
- Smoke density
- Power over Ethernet plus
- EMC
- Segregation class
- Cat./Class

IEC 60754-1/-2, EN 50267-2-1/-2-2 (VDE 0482-267-2-1/-2-2)
 IEC 60332-1-2, EN 60332-1-2 (VDE 0482-332-1-2)
 IEC 60332-3-24, EN 60332-3-24
 IEC 61034-1/-2, EN 61034-1/-2 (VDE 0482-1034-1/-2)
 IEEE 802.3at
 shielded
 d
 Cat 7_A / Class F_A - limit values as specified by IEC 61156-5 and EN 50288-9-1 guaranteed

COPPER DATA CABLES, SHIELDED

Data cable, S/FTP, Category 7_A, AWG23

CU 7120 4P / 2x4P F8

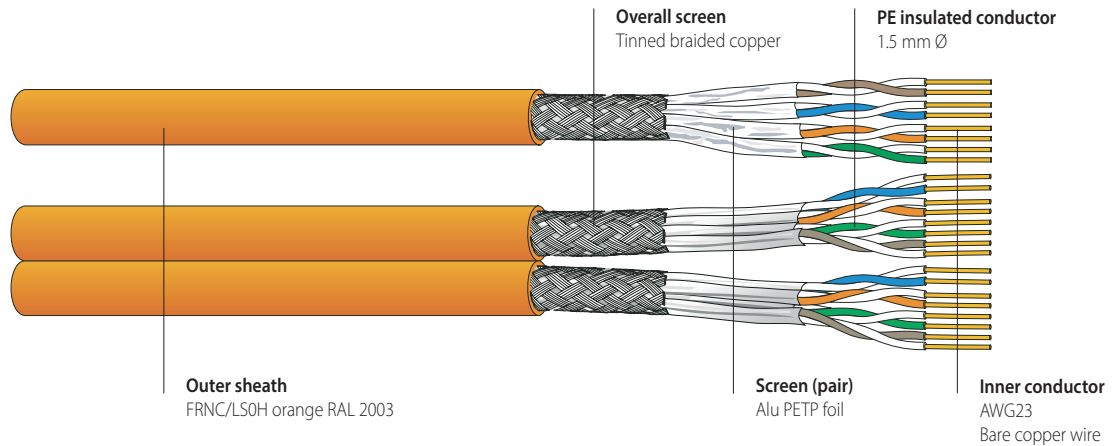

PRODUCT INFORMATION

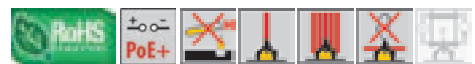

FEATURES

Electrically and mechanically high-quality Cat.7_A data cable - exceeds the requirements of ISO/IEC 11801, IEC 61156-5, EN 50173-1 and prEN 50288-9-1.
 Excellent shielding effect due to individually screened pairs and overall copper braid.
 Reduced outer diameter.
 Compatible with all current connecting hardware in accordance with EN 50173 and ISO/IEC 11801.

APPLICATIONS

Data cable for structured premises cabling.
 For the transmission of digital and analogue voice, video and data signals.
 Suitable for all ICT network applications up to class F_A applications (1000 MHz) in accordance with EN 50173-1 and ISO/IEC 11801 and for the transmission of broadband signals (such as cable TV) in accordance with IEC 15018.
 Applicable for Power over Ethernet (PoE) / PoE+.

VERSIONS

Article No.	Dimension n x n x mm (AWG)	Sheath	Sheath Ø mm	Weight kg/km	Cu weight kg/km	Fire load		PU
						kWh/m	MJ/m	
191466	4 x 2 x 0.59 (AWG23)	FRNC/LSOH ¹⁾	7.6	63.0	32.3	0.18	0.649	1000 m drum
191467	2 x (4 x 2 x 0.59 (AWG23))	FRNC/LSOH ¹⁾	7.6 x 16.0	126.0	64.6	0.36	1.298	500 m drum

¹⁾ FRNC/LSOH = Flame Retardant Non Corrosive / Low Smoke Zero Halogen

Copper

Fibre Optics

Cabinets & Racks

Data Centre

Wireless

Multimedia

General Information

CU 7120 4P 0714/e

ELECTRICAL CHARACTERISTICS

CATEGORY			5e	6	6 _A	7	CATV	7 _A		
Frequency [MHz]	1	4	10	100	250	500	600	862	1000	1200
Attenuation [dB/100m]	1.8	3.5	5.4	17.7	28	41	46	54	57	64
NEXT [dB]	103	103	103	103	103	98	96	92	90	85
PS NEXT [dB]	100	100	100	100	100	95	93	89	87	82
ACR-N [dB]	101	100	98	85	75	57	50	38	33	21
PS-ACR-N [dB]	98	97	95	82	72	54	47	35	30	18
ACR-F [dB]	108	106	104	92	82	69	64	56	53	46
PS-ACR-F [dB]	105	103	101	89	79	66	61	53	50	43
Return loss [dB]	26	30	33	33	28	26	25	24	23	20

These performance data are typical measured values.

Loop resistance at 20° C: 134 Ω/km
 Mutual capacitance 44 pF/m
 Impedance at 100 MHz: 100 Ω ±5 Ω
 Transfer impedance at 1/10/30 MHz: < 5/5/8 mΩ/m
 Coupling attenuation (limit curve of critical state - IEC 61156): > 85 dB
 Near end unbalance attenuation LCL at 1-600 MHz: > 40 dB
 Delay skew: 14 ns/100 m
 NVP: 76 %

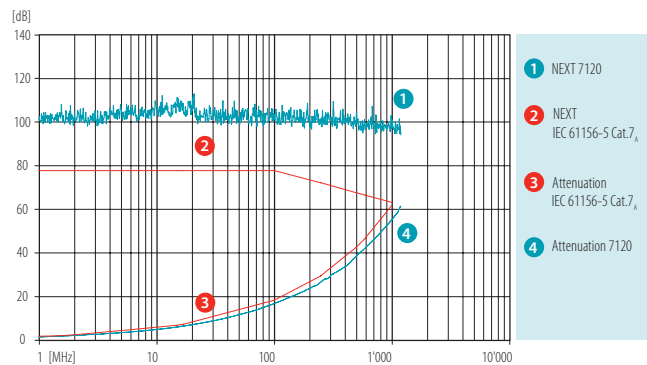

MECHANICAL CHARACTERISTICS

Bending radius (flat side)
 Tensile strength:
 Crush resistance:
 Impact resistance:
 Temperature range

during draw-in:
 permanently installed:
 during installation:
 in operation:

CU 7120 4P

≥ 60 mm
 ≥ 30 mm
 ≤ 110 N
 ≥ 1000 N/10 cm
 ≥ 10 impacts
 0 °C to +50 °C
 -20 °C to +60 °C

CU 7120 2x4P F8

≥ 60 mm
 ≥ 30 mm
 ≤ 220 N
 ≥ 1000 N/10 cm
 ≥ 10 impacts
 0 °C to +50 °C
 -20 °C to +60 °C

GENERAL CHARACTERISTICS

Wire colour code

white/blue
 white/orange
 white/green
 white/brown
 according to IEC 60189 and IEC 60708

Imprint

DATWYLER «cable type» «additional text» «batch number» «meter marks»

- Zero halogen, non corrosive gases
- Flame propagation
- Flame spread
- Smoke density
- Power over Ethernet plus
- EMC
- Segregation
- Cat./Class

IEC 60754-1/-2, EN 50267-2-1/-2-2 (VDE 0482-267-2-1/-2-2)
 IEC 60332-1-2, EN 60332-1-2 (VDE 0482-332-1-2)
 IEC 60332-3-24, EN 60332-3-24
 IEC 61034-1/-2, EN 61034-1/-2 (VDE 0482-1034-1/-2)
 IEEE 802.3at
 shielded
 d
 Cat 7_A / Class F_A - limit values as specified by IEC 61156-5 and EN 50288-9-1 guaranteed

COPPER DATA CABLES, SHIELDED

Data cable, S/FTP, Category 7, AWG23
 CU 7080 4P / 2x4P F8

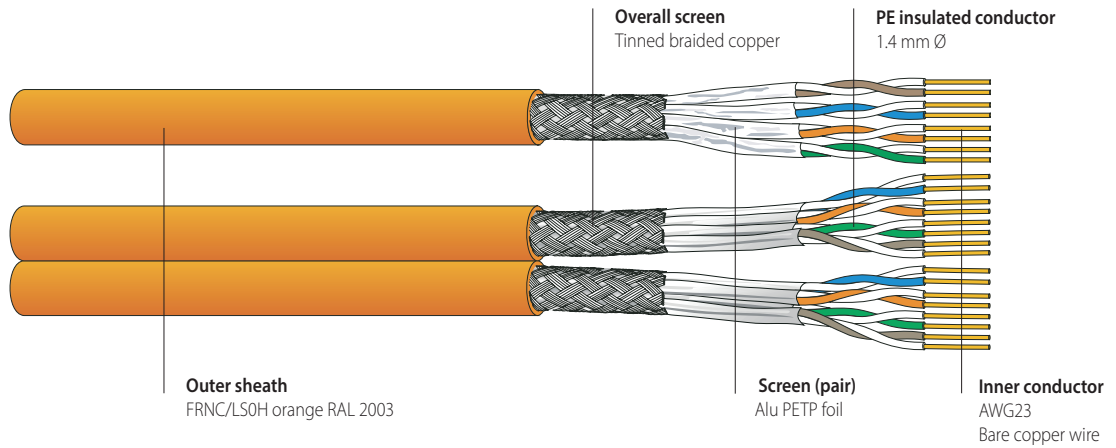

PRODUCT INFORMATION

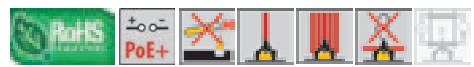

FEATURES

Electrically and mechanically high-quality Cat.7 data cable - exceeds the requirements of ISO/IEC 11801, IEC 61156-5, EN 50173-1 and EN 50288-4-1. Excellent shielding effect due to individually screened pairs and overall copper braid. Compatible with all current connecting hardware in accordance with EN 50173 and ISO/IEC 11801.

APPLICATIONS

Data cable for structured premises cabling. For the transmission of digital and analogue voice, video and data signals. Suitable for all ICT network applications up to class F applications (600 MHz) in accordance with EN 50173-1 and ISO/IEC 11801 and for the transmission of broadband signals (such as cable TV) in accordance with IEC 15018. Applicable for Power over Ethernet (PoE) / PoE+.

VERSIONS

Article No.	Dimension n x n x mm (AWG)	Sheath	Sheath Ø mm	Weight kg/km	Cu weight kg/km	Fire load		PU
						kWh/m	MJ/m	
182911	4 x 2 x 0.57 (AWG23)	FRNC/LSOH ¹⁾	7.4	60	31.1	0.16	0.57	1000 m drum
182912	2 x (4 x 2 x 0.57 (AWG23))	FRNC/LSOH ¹⁾	7.4 x 15.6	120	62.2	0.32	1.14	500 m drum

¹⁾ FRNC/LSOH = Flame Retardant Non Corrosive / Low Smoke Zero Halogen

Copper

Fibre Optics

Cabinets & Racks

Data Centre

Wireless

Multimedia

General Information

CU 7080 4P/2x4P 0714/e

ELECTRICAL CHARACTERISTICS

CATEGORY	5e		6	6 _A	7					
Frequency [MHz]	1	4	10	100	250	500	600	800	862	1000
Attenuation [dB/100m]	1.9	3.6	5.6	17.9	28	41	46	52	54	57
NEXT [dB]	100	100	100	100	100	92	90	84	83	80
PS NEXT [dB]	97	97	97	97	97	89	87	81	80	77
ACR-N [dB]	98	96	94	82	72	58	44	32	29	23
PS-ACR-N [dB]	95	93	91	79	69	55	41	29	26	20
ACR-F [dB]	98	98	98	78	69	56	45	39	37	33
PS-ACR-F [dB]	95	95	95	75	66	53	42	36	34	30
Return loss [dB]	26	30	33	33	28	26	25	23	22	20

These performance data are typical measured values.

Loop resistance at 20° C: 140 Ω/km
 Mutual capacitance: 42 pF/m
 Impedance at 100 MHz: 100 Ω ±5 Ω
 Transfer impedance at 1/10/30 MHz: < 6/6/10 mΩ/m
 Coupling attenuation (limit curve of critical state - IEC 61156): > 85 dB
 Near end unbalance attenuation LCL at 1-600 MHz: > 40 dB
 Delay Skew: 12 ns/100 m
 NVP: 81 %

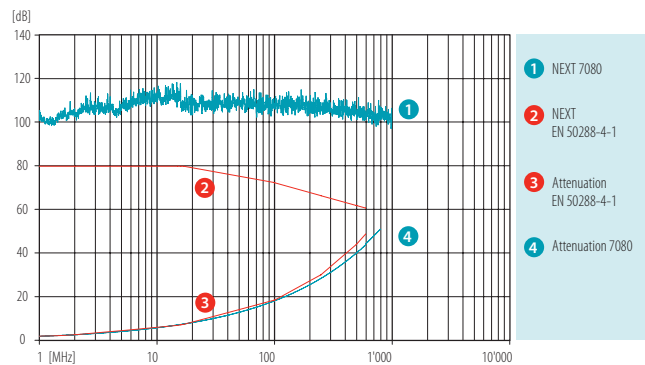

MECHANICAL CHARACTERISTICS

Bending radius (flat side)
 Tensile strength:
 Crush resistance:
 Impact:
 Temperature range

during draw-in:
 permanently installed:
 during installation:
 in operation:

CU 7080 4P

≥ 60 mm
 ≥ 30 mm
 ≤ 110 N
 ≥ 1000 N/10 cm
 ≥ 10 impacts
 0° C to + 50° C
 -20° C to + 60° C

CU 7080 2x4P F8

≥ 60 mm
 ≥ 30 mm
 ≤ 220 N
 ≥ 1000 N/10 cm
 ≥ 10 impacts
 0° C to + 50° C
 -20° C to + 60° C

GENERAL CHARACTERISTICS

Wire colour code

white/blue
 white/orange
 white/green
 white/brown
 in accordance with IEC 60189 and IEC 60708

Imprint

DATWYLER «cable type» «additional text» «batch number» «meter marks»

- Zero halogen, non corrosive gases
- Flame propagation
- Flame spread
- Smoke density
- Power over Ethernet plus
- EMC
- Segregation class
- Cat./Class

IEC 60754-1/-2, EN 50267-2-1/-2-2 (VDE 0482-267-2-1/-2-2)
 IEC 60332-1-2, EN 60332-1-2 (VDE 0482-332-1-2)
 IEC 60332-3-24, EN 60332-3-24
 IEC 61034-1/-2, EN 61034-1/-2 (VDE 0482-1034-1/-2)
 IEEE 802.3at
 shielded
 d
 Cat 7 / Class F - limit values as specified by IEC 61156-5 and EN 50288-4-1 guaranteed

COPPER DATA CABLES, SHIELDED

Data cable, S/FTP, Category 7, AWG23
 CU 7002 4P / 2x4P F8

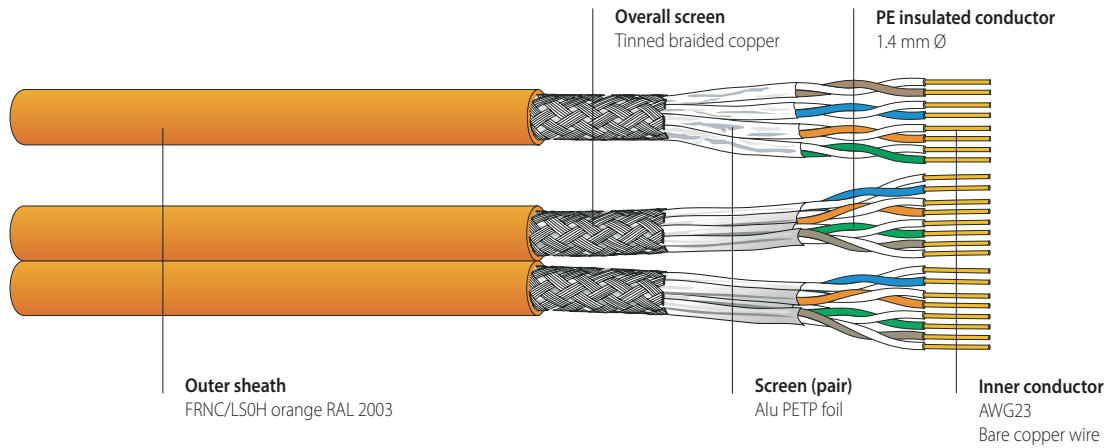

PRODUCT INFORMATION

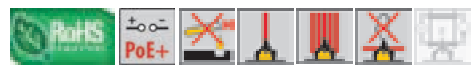

FEATURES

Electrically and mechanically high-quality Cat.7 data cable - exceeds the requirements of ISO/IEC 11801, IEC 61156-5, EN 50173-1 and EN 50288-4-1. Excellent shielding effect due to individually screened pairs and overall copper braid. Compatible with all current connecting hardware in accordance with EN 50173 and ISO/IEC 11801.

APPLICATIONS

Data cable for structured premises cabling. For the transmission of digital and analogue voice, video and data signals. Suitable for all ICT network applications up to class F applications (600 MHz) in accordance with EN 50173-1 and ISO/IEC 11801 and for the transmission of broadband signals (such as cable TV) in accordance with IEC 15018. Applicable for Power over Ethernet (PoE) / PoE+.

VERSIONS

Article No.	Dimension n x n x mm (AWG)	Sheath	Sheath Ø mm	Weight kg/km	Cu weight kg/km	Fire load		PU
						kWh/m	MJ/m	
177388	4 x 2 x 0.57 (AWG23)	FRNC/LSOH ¹⁾	7.4	60	31.1	0.16	0.57	1000 m drum
177398	2 x (4 x 2 x 0.57 (AWG23))	FRNC/LSOH ¹⁾	7.4 x 15.6	120	62.2	0.32	1.14	500 m drum

¹⁾ FRNC/LSOH = Flame Retardant Non Corrosive/Low Smoke Zero Halogen

Copper

Fibre Optics

Cabinets & Racks

Data Centre

Wireless

Multimedia

General Information

CU 7002 4P/2x4P 01714/e

ELECTRICAL CHARACTERISTICS

CATEGORY	5e		6	6 _A	7					
Frequency [MHz]	1	4	10	100	250	500	600	800	862	1000
Attenuation [dB/100m]	1.9	3.6	5.6	17.9	28	41	46	52	54	57
NEXT [dB]	100	100	100	100	100	92	90	84	83	80
PS NEXT [dB]	97	97	97	97	97	89	87	81	80	77
ACR-N [dB]	98	96	94	82	72	58	44	32	29	23
PS-ACR-N [dB]	95	93	91	79	69	55	41	29	26	20
ACR-F [dB]	98	98	98	78	69	56	45	39	37	33
PS-ACR-F [dB]	95	95	95	75	66	53	42	36	34	30
Return loss [dB]	26	30	33	33	28	26	25	23	22	20

These performance data are typical measured values.

Loop resistance at 20° C: 140 Ω/km
 Mutual capacitance: 42 pF/m
 Impedance at 100 MHz: 100 Ω ±5 Ω
 Transfer impedance at 1/10/30 MHz: < 6/6/10 mΩ/m
 Coupling attenuation (limit curve of critical state - IEC 61156): > 85 dB
 Near end unbalance attenuation LCL at 1-600 MHz: > 40 dB
 Delay Skew: 12 ns/100 m
 NVP: 81%

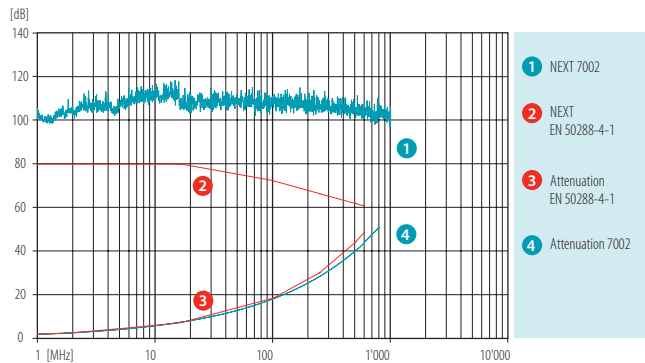

MECHANICAL CHARACTERISTICS

Bending radius (flat side)
 Tensile strength:
 Crush resistance:
 Impact:
 Temperature range

during draw-in:
 permanently installed:
 during installation:
 in operation:

	CU 7002 4P	CU 7002 2x4P F8
during draw-in:	≥ 60 mm	≥ 60 mm
permanently installed:	≥ 30 mm	≥ 30 mm
	≤ 110 N	≤ 220 N
	≥ 1000 N/10 cm	≥ 1000 N/10 cm
	≥ 10 impacts	≥ 10 impacts
during installation:	0° C to + 50° C	0° C to + 50° C
in operation:	-20° C to + 60° C	-20° C to + 60° C

GENERAL CHARACTERISTICS

Wire colour code

white/blue
 white/orange
 white/green
 white/brown
 in accordance with IEC 60189 and IEC 60708

Imprint

DATWYLER «cable type» «additional text» «batch number» «meter marks»

- Zero halogen, non corrosive gases
- Flame propagation
- Flame spread
- Smoke density
- Power over Ethernet plus
- EMC
- Segregation class
- Cat./Class

IEC 60754-1/-2, EN 50267-2-1/-2-2 (VDE 0482-267-2-1/-2-2)
 IEC 60332-1-2, EN 60332-1-2 (VDE 0482-332-1-2)
 IEC 60332-3-24, EN 60332-3-24
 IEC 61034-1/-2, EN 61034-1/-2 (VDE 0482-1034-1/-2)
 IEEE 802.3at
 shielded
 d
 Cat 7 / Class F - limit values as specified by IEC 61156-5 and EN 50288-4-1 guaranteed

COPPER DATA CABLES, SHIELDED

Data cable, S/FTP, Category 7, AWG23
CU 7002 nx4P Breakout Light (BOL)

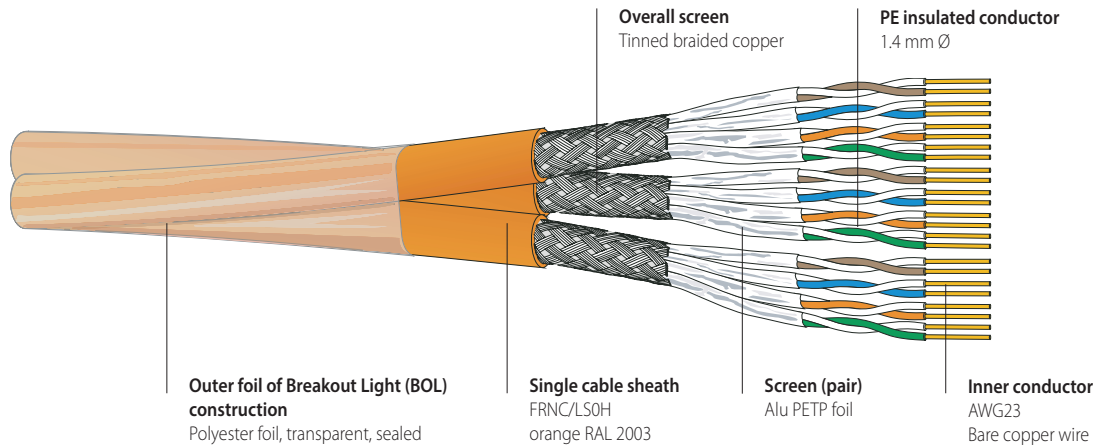

PRODUCT INFORMATION



FEATURES

Electrically and mechanically high-quality Cat.7 data cable - exceeds the requirements of ISO/IEC 11801, IEC 61156-5, EN 50173-1 and EN 50288-4-1. Excellent shielding effect due to individually screened pairs and overall copper braid. Easy handling, small outer diameter and reduced weight thanks to the Breakout Light construction with outer polyester foil instead of an overall cable sheath. Considerable shorter installation time due to the multi-cable construction. Compatible with all current connecting hardware in accordance with EN 50173 and ISO/IEC 11801.

APPLICATIONS

Data cable for structured premises cabling. For the transmission of digital and analogue voice, video and data signals. Suitable for all applications up to class F applications (600 MHz) in accordance with EN 50173-1 and ISO/IEC 11801 and for the transmission of broadband signals (such as cable TV) in accordance with IEC 15018. Applicable for Power over Ethernet (PoE) / PoE+. Especially suitable for Consolidation Points (e.g. in open-plan offices).

VERSIONS

Article No.	Number of elements 4P 1 x 4 x 0.57 (AWG 23)	Sheath	Sheath Ø mm	Weight kg/km	Cu weight kg/km	Fireload MJ/m	PU*
182976	3 x 4P	FRNC/LSOH ¹⁾	16.1	185	93.3	1.71	1000 m drum
182874	4 x 4P	FRNC/LSOH ¹⁾	18.0	245	124.4	2.28	1000 m drum
188486	6 x 4P	FRNC/LSOH ¹⁾	21.2	390	186.6	3.42	1000 m drum

* 500 m und 2000 m drums on request

¹⁾ FRNC/LSOH = Flame Retardant Non Corrosive / Low Smoke Zero Halogen

Copper

Fibre Optics

Cabinets & Racks

Data Centre

Wireless

Multimedia

General Information

CU 7002 4P/nx4P BOL 0714/e

ELECTRICAL CHARACTERISTICS

CATEGORY	5e		6	6 _A	7		
Frequency [MHz]	1	4	10	100	250	500	600
Attenuation [dB/100m]	1.9	3.6	5.6	17.9	28	41	46
NEXT [dB]	100	100	100	100	100	92	90
PS NEXT [dB]	97	97	97	97	97	89	87
ACR-N [dB]	98	96	94	82	72	58	44
PS-ACR-N [dB]	95	93	91	79	69	55	41
ACR-F [dB]	98	98	98	78	69	56	45
PS-ACR-F [dB]	95	95	95	75	66	53	42
Return loss [dB]	26	30	33	33	28	26	25

These performance data are typical measured values.

Loop resistance at 20°C: 140 Ω/km
 Mutual capacitance: 42 pF/m
 Impedance at 100 MHz: 100 Ω ±5 Ω
 Transfer impedance at 1/10/30 MHz: < 6/6/10 mΩ/m
 Coupling attenuation (limit curve of critical state - IEC 61156): > 85 dB
 Near end unbalance attenuation LCL at 1-600 MHz: > 40 dB
 Delay Skew: 12 ns/100 m
 NVP: 81 %

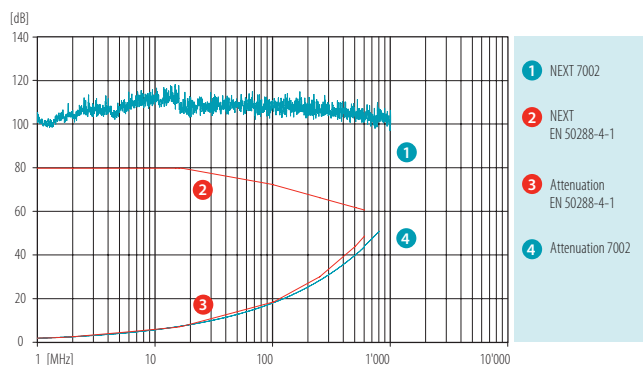

MECHANICAL CHARACTERISTICS

Bending radius (flat side)	during draw-in:	CU 7002 3x4P	CU 7002 4x4P	CU 7002 6x4P
	permanently installed:	≥ 130 mm	≥ 144 mm	≥ 170 mm
Tensile strength:		≥ 65 mm	≥ 72 mm	≥ 85 mm
Crush resistance:		≤ 300 N	≤ 400 N	≤ 600 N
Impact:		≥ 1000 N/10 cm	≥ 10 impacts	
Temperature range	during installation:	0° C to + 50° C		
	in operation:	-20° C to + 60° C		

GENERAL CHARACTERISTICS

Wire colour code	white/blue white/orange white/green white/brown in accordance with IEC 60189 and IEC 60708
Imprint	DATWYLER «cable type» «additional text» «batch number» «meter marks»
Zero halogen, non corrosive gases	IEC 60754-1/-2, EN 50267-2-1/-2-2 (VDE 0482-267-2-1/-2-2)
Flame propagation	IEC 60332-1-2, EN 60332-1-2 (VDE 0482-332-1-2)
Flame spread	IEC 60332-3-24, EN 60332-3-24
Smoke density	IEC 61034-1/-2, EN 61034-1/-2, (VDE 0482-1034-1/-2)
Power over Ethernet plus	IEEE 802.3at
EMC	shielded
Segregation Class	d
Cat./Class	Cat 7 / Class F - limit values as specified by IEC 61156-5 and EN 50288-4-1 guaranteed

Industrial data cable, S/FTP, Category 7, AWG23

CU 7002 4P Industrial PUR

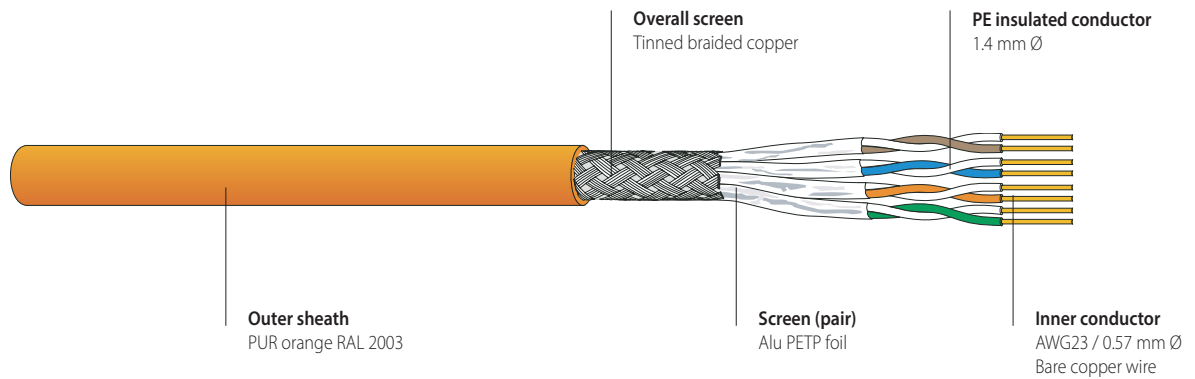

PRODUCT INFORMATION



FEATURES

Electrically and mechanically high-quality Cat.7 data cable with PUR sheath - exceeds the requirements of ISO/IEC 11801, IEC 61156-5, EN 50173-1 and EN 50288-4-1. Compatible with Datwyler IP67 connecting hardware. Excellent shielding effect due to individually screened pairs and overall copper braid. Compatible with all current connecting hardware in accordance with EN 50173 and ISO/IEC 11801.

APPLICATIONS

Data cable for structured premises cabling - designed for use in indoor and outdoor industrial areas. Oil resistant. For the transmission of digital and analogue voice, video and data signals. Suitable for all ICT network applications up to class F applications (600 MHz) in accordance with EN 50173-1 and ISO/IEC 11801. Applicable for Power over Ethernet (PoE) / PoE+.

VERSIONS

Article No.	Dimension n x n x mm (AWG)	Sheath	Sheath Ø mm	Weight kg/km	Cu weight kg/km	Fire load kWh/m MJ/m	PU
187689	4 x 2 x 0.57 (AWG23)	PUR ¹⁾	7.9	73.9	31.1	0.19 0.70	1000 m drum

¹⁾ PUR = Polyurethane

ELECTRICAL CHARACTERISTICS

CATEGORY	5e		6	6 _A	7		
Frequency [MHz]	1	4	10	100	250	500	600
Attenuation [dB/100m]	1.9	3.6	5.6	17.9	28	41	46
NEXT [dB]	100	100	100	100	100	92	90
PS NEXT [dB]	97	97	97	97	97	89	87
ACR [dB]	98	96	94	82	72	58	44
PS ACR [dB]	95	93	91	79	69	55	41
ELFEXT [dB]	98	98	98	78	69	56	45
PS ELFEXT [dB]	95	95	95	75	66	53	42
Return loss [dB]	26	30	33	33	28	26	25

These performance data are typical measured values.

Loop resistance at 20° C: 140 Ω/km
 Mutual capacitance: 42 pF/m
 Impedance at 100 MHz: 100 Ω ±5 Ω
 Transfer impedance at 1/10/30 MHz: < 6/6/10 mΩ/m
 Coupling attenuation (limit curve of critical state - IEC 61156) > 85 dB
 Near end unbalance attenuation LCL at 1-600 MHz: > 40 dB
 Delay Skew: 12 ns/100 m
 NVP: 81 %

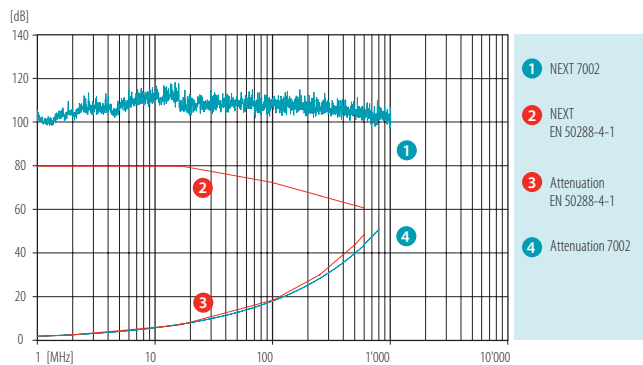

MECHANICAL CHARACTERISTICS

Bending radius during draw-in: ≥ 60 mm
 permanently installed: ≥ 30 mm
 Tensile strength: ≤ 110 N
 Crush resistance: ≥ 1000 N/10 cm
 Impact: ≥ 10 impacts
 Temperature range during installation: 0° C to + 50° C
 in operation: -30° C to + 60° C

GENERAL CHARACTERISTICS

Wire colour code white/blue, white/orange, white/green, white/brown, in accordance with IEC 60189 and IEC 60708

Imprint DATWYLER «cable type» «additional text» «batch number» «meter marks»

Zero halogen IEC 60754-1/-2, EN 50267-2-1/-2-2 (VDE 0482-267-2-1/-2-2)
 Flame propagation IEC 60332-1-2, EN 60332-1-2 (VDE 0482-332-1-2)
 Oil-resistant EN 60811-2-1
 Power over Ethernet plus IEEE 802.3at
 EMC shielded
 Segregation class d
 Cat./Class Cat 7 / Class F - limit values as specified by IEC 61156-5 and EN 50288-4-1 guaranteed

COPPER DATA CABLES, SHIELDED

Data cable, S/FTP, Category 7, AWG23

CU 7002 4P GG-PE

with rodent protection and PE cable sheath

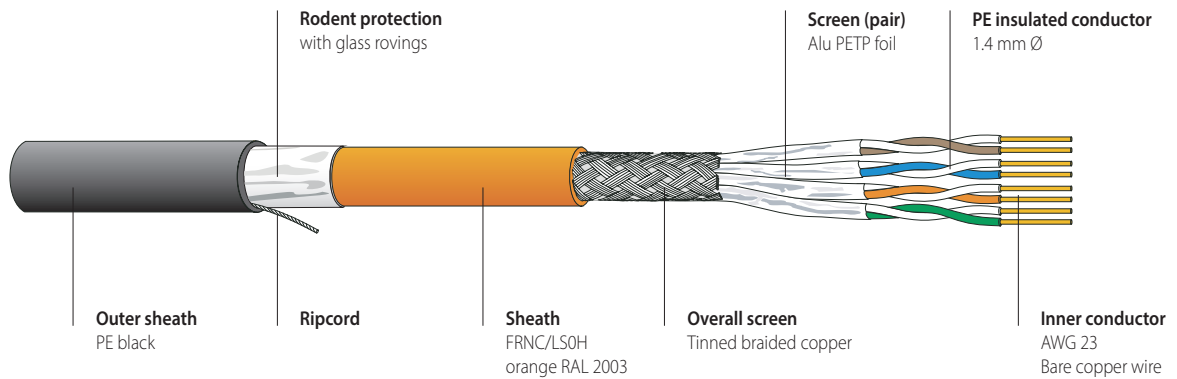

PRODUCT INFORMATION



FEATURES

Applicable for outdoor installation due to rodent protection and PE outer cable sheath with higher UV resistance.
 Robust cable design with a high mechanical stability.
 Electrically and mechanically high-quality Cat.7 data cable - exceeds the requirements of ISO/IEC 11801, IEC 61156-5, EN 50173-1 and EN 50288-4-1.
 Excellent shielding effect due to individually screened pairs and overall copper braid.
 Compatible with all current connecting hardware in accordance with EN 50173 and ISO/IEC 11801.

APPLICATIONS

Data cable for structured premises and outdoor cabling.
 With rodent protection and increased UV protection (due to PE outer sheath).
 For the transmission of digital and analogue voice, video and data signals.
 Suitable for all ICT network applications up to class F applications (600 MHz) in accordance with EN 50173-1 and ISO/IEC 11801.
 Applicable for Power over Ethernet (PoE) / PoE+.

VERSIONS

Article No.	Dimension n x n x mm (AWG)	Sheath	Sheath Ø mm	Weight kg/km	Cu weight kg/km	Fire load		PU
						kWh/m	MJ/m	
191923	4 x 2 x 0.57 (AWG23)	FRNC/LSOH-PE ¹⁾	11.8	141	31.1	0.75	2.69	on request

¹⁾ FRNC/LSOH = Flame Retardant Non Corrosive /Low Smoke Zero Halogen

Copper

Fibre Optics

Cabinets & Racks

Data Centre

Wireless

Multimedia

General Information

CU 7002 4P GG-PE 0714/e

Data cable, S/FTP, Category 7, AWG23

CU 7002 4P GG-PE

with rodent protection and PE cable sheeth

ELECTRICAL CHARACTERISTICS

CATEGORY	5e		6	6 _A	7		
Frequency [MHz]	1	4	10	100	250	500	600
Attenuation [dB/100m]	1.9	3.6	5.6	17.9	28	41	46
NEXT [dB]	100	100	100	100	100	92	90
PS NEXT [dB]	97	97	97	97	97	89	87
ACR-N [dB]	98	96	94	82	72	58	44
PS-ACR-N [dB]	95	93	91	79	69	55	41
ACR-F [dB]	98	98	98	78	69	56	45
PS-ACR-F [dB]	95	95	95	75	66	53	42
Return loss [dB]	26	30	33	33	28	26	25

These performance data are typical measured values.

Loop resistance at 20° C: 140 Ω/km
 Mutual capacitance: 42 pF/m
 Impedance at 100 MHz: 100 Ω ±5 Ω
 Coupling attenuation (limit curve of critical state - IEC 61156): > 85 dB
 Near end unbalance attenuation LCL at 1-600 MHz: > 40 dB
 Delay Skew: 12 ns/100 m
 NVP: 81 %

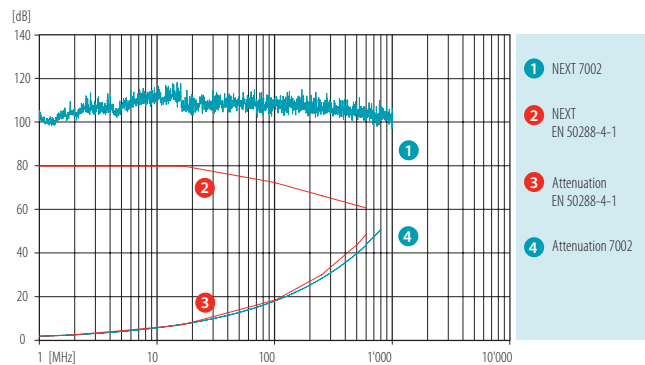

MECHANICAL CHARACTERISTICS

Bending radius during draw-in: ≥ 92 mm
 permanently installed: ≥ 46 mm
 Tensile strength: ≤ 150 N
 Crush resistance: ≥ 2000 N/10 cm
 Impact: ≥ 20 impacts
 Temperature range during installation: 0° C to + 50° C
 in operation: -20° C to + 60° C

GENERAL CHARACTERISTICS

Wire colour code white/blue
 white/orange
 white/green
 white/brown
 in accordance with IEC 60189 and IEC 60708

Imprint DATWYLER «cable type» «additional text» «batch number» «meter marks»

- Zero halogen, non corrosive gases
 - Smoke density
 - Power over Ethernet plus
 - EMC
 - Segregation Class
 - Cat./Class
- IEC 60754-1/-2, EN 50267-2-1/-2-2 (VDE 0482-267-2-1/-2-2)
 IEC 61034-1/-2, EN 61034-1/-2 (VDE 0482-1034-1/-2)
 IEEE 802.3at shielded
 d
 Cat 7 / Class F - limit values as specified by IEC 61156-5 and EN 50288-4-1 guaranteed

Data cable, F/FTP, Category 7, AWG23

CU 7052 4P / 2x4P F8

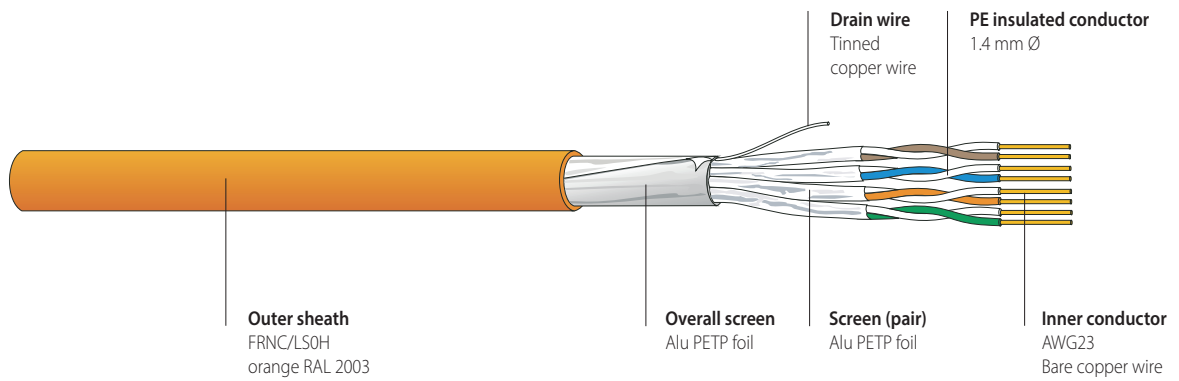

PRODUCT INFORMATION

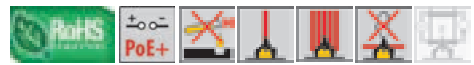

FEATURES

Electrically and mechanically high-quality Cat.7 data cable - exceeds the requirements of ISO/IEC 11801, IEC 61156-5, EN 50173-1 and EN 50288-4-1. Excellent shielding effect due to individually screened pairs and overall foil screen. Compatible with all current connecting hardware in accordance with EN 50173 and ISO/IEC 11801.

APPLICATIONS

Data cable for structured premises cabling. For the transmission of digital and analogue voice, video and data signals. Suitable for all ICT network applications up to class F applications (600 MHz) in accordance with EN 50173-1 and ISO/IEC 11801 and for the transmission of broadband signals (such as cable TV) in accordance with IEC 15018. Applicable for Power over Ethernet (PoE) / PoE+.

VERSIONS

Article No.	Dimension n x n x mm (AWG)	Sheath	Sheath Ø mm	Weight kg/km	Cu weight kg/km	Fire load		PU
						kWh/m	MJ/m	
188514	4 x 2 x 0.57 (AWG23)	FRNC/LSOH ¹⁾	7.3	52	21.3	0.16	0.58	1000 m drum
188515	2 x (4 x 2 x 0.57 (AWG23))	FRNC/LSOH ¹⁾	7.3 x 15.4	104	42.6	0.32	1.16	500 m drum

¹⁾ FRNC/LSOH = Flame Retardant Non Corrosive / Low Smoke Zero Halogen

ELECTRICAL CHARACTERISTICS

CATEGORY	5e		6	6 _A	7	8		
Frequency [MHz]	1	4	10	100	250	500	600	862
Attenuation [dB/100m]	1.9	3.6	5.6	17.9	28	41	46	54
NEXT [dB]	98	98	98	98	98	90	88	81
PS NEXT [dB]	95	95	95	95	95	87	85	78
ACR-N [dB]	96	94	92	80	70	56	42	27
PS-ACR-N [dB]	93	91	89	77	67	53	39	24
ACR-F [dB]	96	96	96	76	68	54	43	35
PS-ACR-F [dB]	93	93	93	73	64	51	40	32
Return loss [dB]	24	28	31	31	26	24	23	20

These performance data are typical measured values.

Loop resistance at 20° C: 140 Ω/km
 Mutual capacitance: 42 pF/m
 Impedance at 100 MHz: 100 Ω ±5 Ω
 Coupling attenuation (limit curve of critical state - IEC 61156): > 85 dB
 Near end unbalance attenuation LCL at 1-600 MHz: > 40 dB
 Delay Skew: 12 ns/100 m
 NVP: 81 %

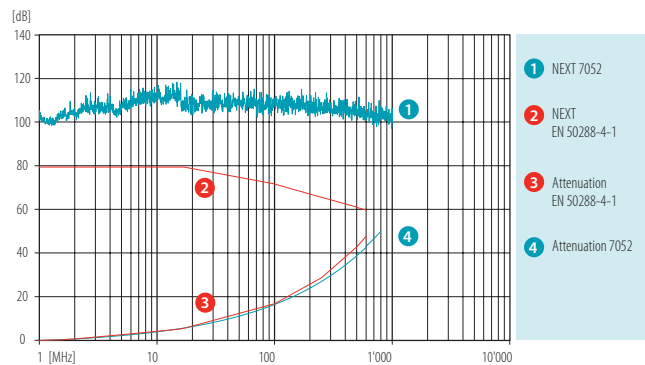

MECHANICAL CHARACTERISTICS

Bending radius (flat side)
 Tensile strength:
 Crush resistance:
 Impact:
 Temperature range

during draw-in:
 permanently installed:
 during installation:
 in operation:

CU 7052 4P

≥ 60 mm
 ≥ 30 mm
 ≤ 110 N
 ≥ 1000 N/10 cm
 ≥ 10 impacts
 0° C to + 50° C
 -20° C to + 60° C

CU 7052 2x4P F8

≥ 60 mm
 ≥ 30 mm
 ≤ 220 N
 ≥ 1000 N/10 cm
 ≥ 10 impacts
 0° C to + 50° C
 -20° C to + 60° C

GENERAL CHARACTERISTICS

Wire colour code

white/blue
 white/orange
 white/green
 white/brown
 in accordance with IEC 60189 and IEC 60708

Imprint

DATWYLER «cable type» «additional text» «batch number» «meter marks»

- Zero halogen, non corrosive gases
- Flame propagation
- Flame spread
- Smoke density

IEC 60754-1/-2, EN 50267-2-1/-2-2, VDE 0482-267-2-1/-2-2
 IEC 60332-1-2, EN 60332-1-2, VDE 0482-332-1-2
 IEC 60332-3-24, EN 50266-24 Cat. C, VDE 0482-266-2-4 Cat. C
 IEC 61034-1/-2, EN 61034-1/-2 (EN 50268-1/-2),
 VDE 0482-1034-1/-2 (VDE 0482-268)-1/-2)

- Power over Ethernet plus
- EMC
- Segregation class
- Cat./Class

IEEE 802.3at
 shielded
 c
 Cat 7 / Class F - limit values as specified by IEC 61156-5 and EN 50288-4-1 guaranteed

COPPER DATA CABLES, SHIELDED

Data cable, S/FTP, Category 6_A, AWG23

CU 7060 4P / 2x4P F8

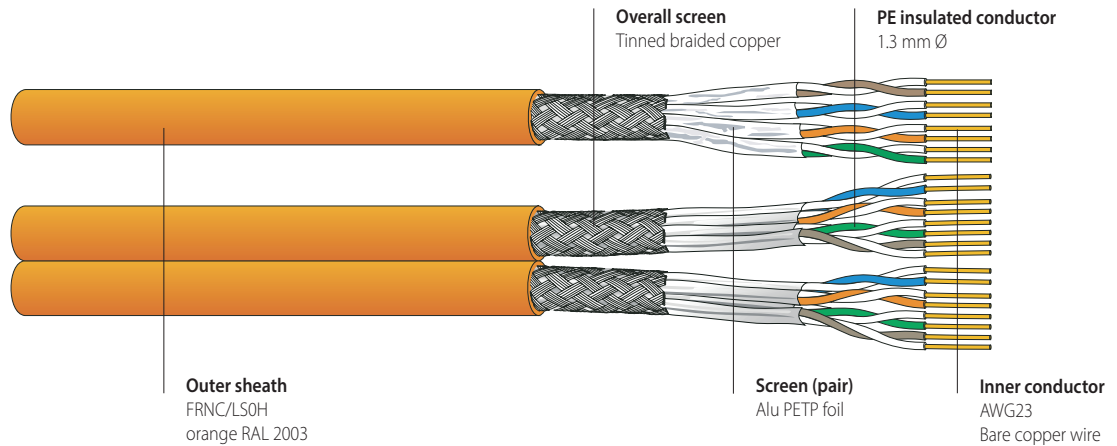

PRODUCT INFORMATION



FEATURES

Electrically and mechanically high-quality Cat.6_A data cable - exceeds the requirements of ISO/IEC 11801, IEC 61156-5, EN 50173-1 and prEN 50288-10-1. Excellent shielding effect due to individually screened pairs and overall copper braid. Compatible with all current connecting hardware in accordance with EN 50173 and ISO/IEC 11801.

APPLICATIONS

Data cable for structured premises cabling. For the transmission of digital and analogue voice, video and data signals. Suitable for all ICT network applications up to class E_A applications (500 MHz) in accordance with EN 50173-1 and ISO/IEC 11801. Applicable for Power over Ethernet (PoE) / PoE+.

VERSIONS

Article No.	Dimension n x n x mm (AWG)	Sheath	Sheath Ø mm	Weight kg/km	Cu weight kg/km	Fire load		PU
						kWh/m	MJ/m	
182924	4 x 2 x 0.55 (AWG23)	FRNC/LSOH ¹⁾	7.1	55.0	26.4	0.152	0.55	1000 m drum
182927	2 x (4 x 2 x 0.55 (AWG23))	FRNC/LSOH ¹⁾	7.1 x 15	110.0	52.8	0.304	1.10	500 m drum

¹⁾ FRNC/LSOH = Flame Retardant Non Corrosive /Low Smoke Zero Halogen

Copper

Fibre Optics

Cabinets & Racks

Data Centre

Wireless

Multimedia

General Information

CU 7060 4P 0714/e

ELECTRICAL CHARACTERISTICS

CATEGORY	5e		6	6 _A			
Frequency [MHz]	1	4	10	100	250	500	600
Attenuation [dB/100m]	2.1	3.8	5.9	19.8	30	43	47
NEXT [dB]	93	93	93	93	82	77	75
PS NEXT [dB]	90	90	90	90	79	74	72
ACR-N [dB]	91	89	87	73	52	34	28
PS-ACR-N [dB]	88	86	84	70	49	31	25
ACR-F [dB]	96	96	96	74	61	43	39
PS-ACR-F [dB]	93	93	93	71	58	40	36
Return loss [dB]	26	28	30	30	27	25	24

These performance data are typical measured values.

Loop resistance at 20° C: 146 Ω/km
 Mutual capacitance: 42 pF/m
 Impedance at 100 MHz: 100 Ω ±5 Ω
 Transfer impedance at 1/10/30 MHz: < 6/10/20 mΩ/m
 Coupling attenuation (limit curve of critical state - IEC 61156): > 75 dB
 Near end unbalance attenuation LCL at 1-600 MHz: > 40 dB
 Delay Skew: 4 ns/100 m
 NVP: 80 %

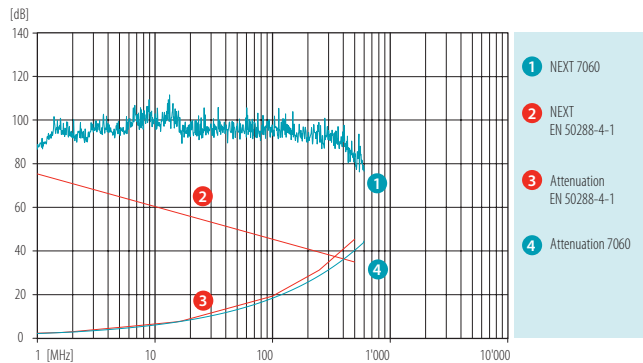

MECHANICAL CHARACTERISTICS

Bending radius
 Tensile strength:
 Crush resistance:
 Impact:
 Temperature range

during draw-in:
 permanently installed:
 during installation:
 in operation:

	CU 7060 4P	CU 7060 2x4P F8
during draw-in:	≥ 65 mm	≥ 65 mm
permanently installed:	≥ 30 mm	≥ 30 mm
	≤ 95 N	≥ 190 N
	≥ 1000 N/10 cm	≥ 1000 N/10 cm
	≥ 10 impacts	≥ 10 impacts
during installation:	0° C to + 50° C	0° C to + 50° C
in operation:	-20° C to + 60° C	-20° C to + 60° C

GENERAL CHARACTERISTICS

Wire colour code

white/blue
 white/orange
 white/green
 white/brown
 in accordance with IEC 60189 and IEC 60708

Imprint

DATWYLER «cable type» «additional text» «batch number» «meter marks»

- Zero halogen, non corrosive gases
- Flame propagation
- Flame spread
- Smoke density
- Power over Ethernet plus
- EMC
- Segregation class
- Cat./Class

IEC 60754-1/-2, EN 50267-2-1/-2-2 (VDE 0482-267-2-1/-2-2)
 IEC 60332-1-2, EN 60332-1-2 (VDE 0482-332-1-2)
 IEC 60332-3-24, EN 60332-3-24
 IEC 61034-1/-2, EN 61034-1/-2 (VDE 0482-1034-1/-2)
 IEEE 802.3at
 shielded
 c
 Cat 6_A / Class E_A - limit values as specified by IEC 61156-5 and EN 50288-10-1 guaranteed (typical values of Cat.7 for lengths up to ~70 m)

Data cable, F/FTP, Category 6_A, AWG23

CU 6552 4P / 2x4P F8

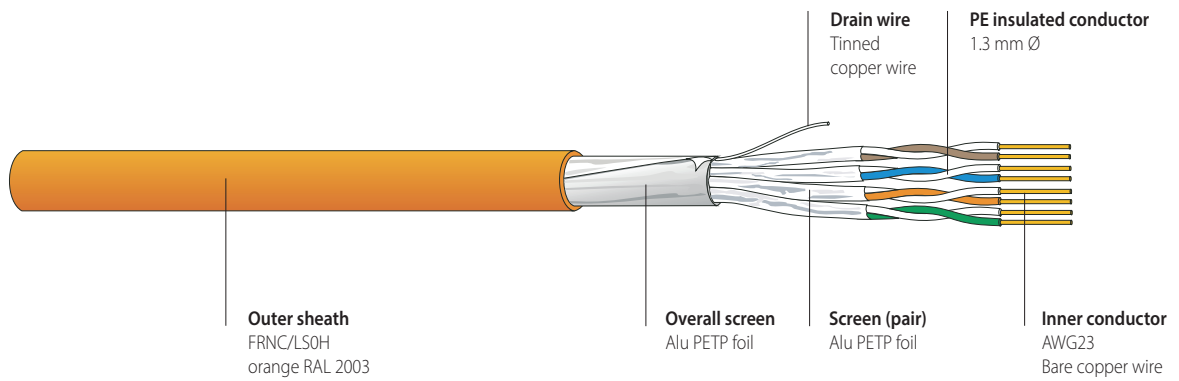

PRODUCT INFORMATION



FEATURES

Electrically and mechanically high-quality Cat.6_A data cable - exceeds the requirements of ISO/IEC 11801, IEC 61156-5, EN 50173-1 and prEN 50288-10-1. Excellent shielding effect due to individually screened pairs and overall foil screen. Compatible with all current connecting hardware in accordance with EN 50173 and ISO/IEC 11801.

APPLICATIONS

Data cable for structured premises cabling. For the transmission of digital and analogue voice, video and data signals. Suitable for all ICT network applications up to class E_A applications (500 MHz) in accordance with EN 50173-1 and ISO/IEC 11801. Applicable for Power over Ethernet (PoE) / PoE+.

VERSIONS

Article No.	Dimension n x n x mm (AWG)	Sheath	Sheath Ø mm	Weight kg/km	Cu weight kg/km	Fire load		PU
						kWh/m	MJ/m	
191454	4 x 2 x 0.55 (AWG 23)	FRNC/LSOH ¹⁾	7.0	48.5	20.0	0.14	0.52	1000 m drum
191456	2 x (4 x 2 x 0.55 (AWG 23))	FRNC/LSOH ¹⁾	7.0 x 14.3	97.0	40.0	0.28	1.04	500 m drum

¹⁾ FRNC/LSOH = Flame Retardant Non Corrosive / Low Smoke Zero Halogen

ELECTRICAL CHARACTERISTICS

CATEGORY	5e		6	6 _A		
Frequency [MHz]	1	4	10	100	250	500
Attenuation [dB/100m]	2.1	3.8	5.9	19.0	30	43
NEXT [dB]	93	93	93	93	83	75
PS NEXT [dB]	90	90	90	90	80	72
ACR-N [dB]	91	89	87	73	53	32
PS-ACR-N [dB]	88	86	84	70	50	29
ACR-F [dB]	96	96	96	74	56	33
PS-ACR-F [dB]	93	93	93	71	53	30
Return loss [dB]	26	28	30	30	27	21

These performance data are typical measured values.

Loop resistance at 20° C: 150 Ω/km
 Mutual capacitance: 42 pF/m
 Impedance at 100 MHz: 100 Ω ±5 Ω
 Transfer impedance at 1/10/30 MHz: < 50/100/200 mΩ/m
 Coupling attenuation (limit curve of critical state - IEC 61156): > 70 dB
 Near end unbalance attenuation LCL at 1/10/100 MHz: > 40 dB
 Delay Skew: 5 ns/100 m
 NVP: 79 %

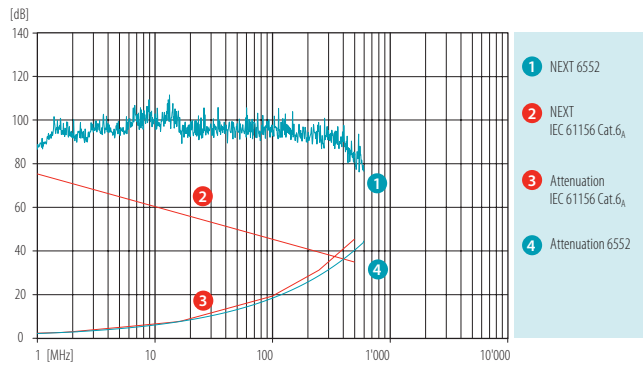

MECHANICAL CHARACTERISTICS

Bending radius	during draw-in:	CU 6552 4P	CU 6552 2x4P F8
	permanently installed:	≥ 56 mm	≥ 56 mm
Tensile strength:		≥ 28 mm	≥ 28 mm
Crush resistance:		≤ 95 N	≤ 190 N
Impact:		≥ 1000 N/10 cm	≥ 1000 N/10 cm
Temperature range	during installation:	≥ 10 impacts	≥ 10 impacts
	in operation:	0° C to + 50° C	0° C to + 50° C
		-20° C to + 60° C	-20° C to + 60° C

GENERAL CHARACTERISTICS

Wire colour code	white/blue
	white/orange
	white/green
	white/brown
	in accordance with IEC 60189 and IEC 60708

Imprint DATWYLER «cable type» «additional text» «batch number» «meter marks»

- Zero halogen, non corrosive gases
- Flame propagation
- Flame spread
- Smoke density
- Power over Ethernet
- EMC
- Segregation class c
- Cat 6_A / Class E_A - limit values as specified by IEC 61156-5 and EN 50288-10-1 guaranteed

Data cable, U/FTP, Category 6_A, AWG23

CU 6502 4P / 2x4P F8

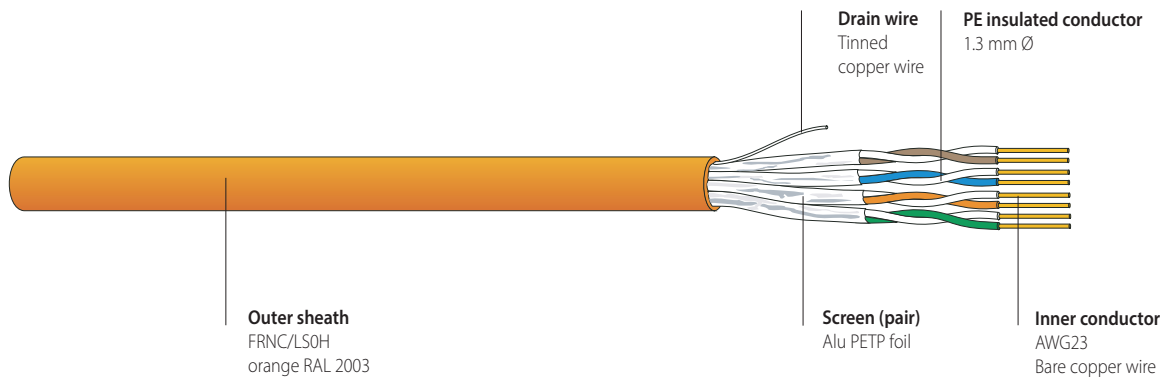

PRODUCT INFORMATION

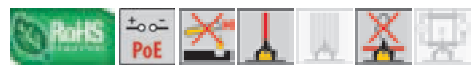

FEATURES

Electrically and mechanically high-quality Cat.6_A data cable - exceeds the requirements of ISO/IEC 11801, IEC 61156-5, EN 50173-1 and prEN 50288-10-1. Good shielding effect due to individually screened pairs. Compatible with all current connecting hardware in accordance with EN 50173 and ISO/IEC 11801.

APPLICATIONS

Data cable for structured premises cabling. For the transmission of digital and analogue voice, video and data signals. Suitable for all ICT network applications up to class E_A applications (500 MHz) in accordance with EN 50173-1 and ISO/IEC 11801. Applicable for Power over Ethernet (PoE) / PoE+.

VERSIONS

Article No.	Dimension n x n x mm (AWG)	Sheath	Sheath Ø mm	Weight kg/km	Cu weight kg/km	Fire load		PU
						kWh/m	MJ/m	
191453	4 x 2 x 0.55 (AWG 23)	FRNC/LS0H ¹⁾	7.0	47.8	20.0	0.15	0.55	1000 m drum
191455	2 x (4 x 2 x 0.55 (AWG 23))	FRNC/LS0H ¹⁾	7.0 x 14.3	95.6	40.0	0.30	1.10	500 m drum

¹⁾ FRNC/LS0H = Flame Retardant Non Corrosive /Low Smoke Zero Halogen

ELECTRICAL CHARACTERISTICS

CATEGORY	5e		6	6 _A		
Frequency [MHz]	1	4	10	100	250	500
Attenuation [dB/100m]	2.1	3.8	5.9	19.0	30	43
NEXT [dB]	93	93	93	93	83	75
PS NEXT [dB]	90	90	90	90	80	72
ACR-N [dB]	91	89	87	73	53	32
PS-ACR-N [dB]	88	86	84	70	50	29
ACR-F [dB]	96	96	96	74	56	33
PS-ACR-F [dB]	93	93	93	71	53	30
Return loss [dB]	26	28	30	30	27	21

These performance data are typical measured values.

Loop resistance at 20° C: 150 Ω/km
 Mutual capacitance: 42 pF/m
 Impedance at 100 MHz: 100 Ω ±5 Ω
 Transfer impedance at 1/10/30 MHz: < 50/100/200 mΩ/m
 Coupling attenuation (limit curve of critical state - IEC 61156): > 55 dB
 Near end unbalance attenuation LCL at 1/10/100 MHz: > 40 dB
 Delay Skew: 5 ns/100 m
 NVP: 79 %

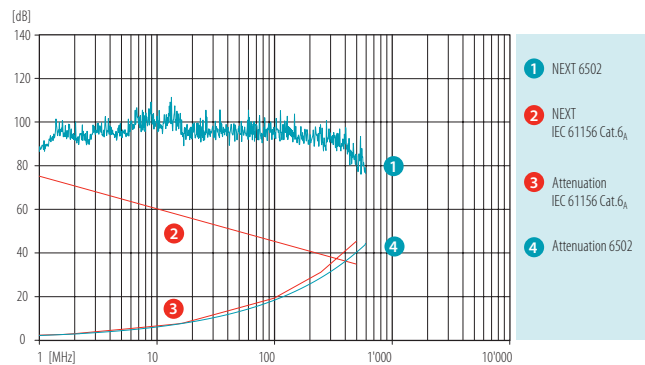

MECHANICAL CHARACTERISTICS

Bending radius	during draw-in:	CU 6502 4P	CU 6502 2x4P F8
	permanently installed:	≥ 56 mm	≥ 56 mm
Tensile strength:		≥ 28 mm	≥ 28 mm
Crush resistance:		≤ 95 N	≤ 190 N
Impact:		≥ 1000 N/10 cm	≥ 1000 N/10 cm
Temperature range	during installation:	≥ 10 impacts	≥ 10 impacts
	in operation:	0° C to + 50° C	0° C to + 50° C
		-20° C to + 60° C	-20° C to + 60° C

GENERAL CHARACTERISTICS

Wire colour code: white/blue, white/orange, white/green, white/brown, in accordance with IEC 60189 and IEC 60708

Imprint: DATWYLER «cable type» «additional text» «batch number» «meter marks»

- Zero halogen, non corrosive gases
- Flame propagation
- Smoke density
- Power over Ethernet
- EMC
- Segregation class c
- Cat 6_A / Class E_A - limit values as specified by IEC 61156-5 and EN 50288-10-1 guaranteed

Data cable, F/FTP, Category 6, AWG23

CU 6052 4P / 2x4P F8

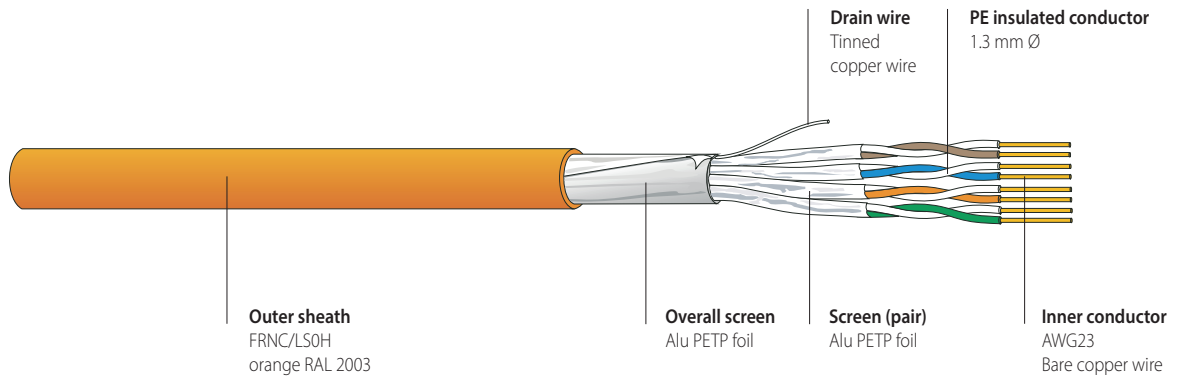

PRODUCT INFORMATION

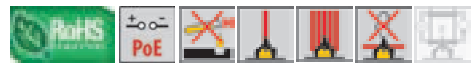

FEATURES

Electrically and mechanically high-quality Cat.6 data cable - fulfils the requirements of ISO/IEC 11801, IEC 61156-5, EN 50173-1 and EN 50288-5-1.
Good shielding effect due to individually screened pairs and overall foil screen.
Compatible with all current connecting hardware in accordance with EN 50173 and ISO/IEC 11801.

APPLICATIONS

Data cable for structured premises cabling.
For the transmission of digital and analogue voice, video and data signals.
Suitable for all ICT network applications up to class E applications (250 MHz) in accordance with EN 50173-1 and ISO/IEC 11801.
Applicable for Power over Ethernet (PoE) / PoE+.

VERSIONS

Article No.	Dimension n x n x mm (AWG)	Sheath	Sheath Ø mm	Weight kg/km	Cu weight kg/km	Fire load		PU
						kWh/m	MJ/m	
188512	4 x 2 x 0.55 (AWG 23)	FRNC/LSOH ¹⁾	7.0	48.7	20.0	0.144	0.517	1000 m drum
188513	2 x (4 x 2 x 0.55 (AWG 23))	FRNC/LSOH ¹⁾	7.0 x 14.8	97.7	40.0	0.225	0.810	500 m drum

¹⁾ FRNC/LSOH = Flame Retardant Non Corrosive / Low Smoke Zero Halogen

ELECTRICAL CHARACTERISTICS

CATEGORY	5e		6			
Frequency [MHz]	1	4	10	100	250	300
Attenuation [dB/100m]	2.1	3.8	5.9	19.8	30	32
NEXT [dB]	93	93	93	93	83	80
PS NEXT [dB]	90	90	90	90	80	79
ACR-N [dB]	91	89	87	73	53	48
PS-ACR-N [dB]	88	86	84	70	50	45
ACR-F [dB]	96	96	96	74	56	49
PS-ACR-F [dB]	93	93	93	71	53	46
Return loss [dB]	26	28	30	30	27	26

These performance data are typical measured values.

Loop resistance at 20° C: 150 Ω/km
 Mutual capacitance: 42 pF/m
 Impedance at 100 MHz: 100 Ω ±5 Ω
 Transfer impedance at 1/10/30 MHz: < 50/100/200 mΩ/m
 Coupling attenuation (limit curve of critical state - IEC 61156): > 65 dB
 Near end unbalance attenuation LCL at 1/10/100 MHz: > 40 dB
 Delay Skew: 5 ns/100 m
 NVP: 79 %

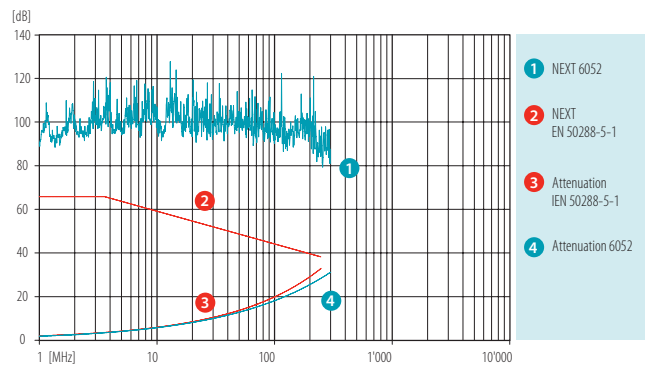

MECHANICAL CHARACTERISTICS

Bending radius	during draw-in:	CU 6052 4P	CU 6052 2x4P F8
	permanently installed:	≥ 56 mm	≥ 56 mm
Tensile strength:		≥ 28 mm	≥ 28 mm
Crush resistance:		≤ 95 N	≤ 190 N
Impact:		≥ 1000 N/10 cm	≥ 1000 N/10 cm
Temperature range	during installation:	≥ 10 impacts	≥ 10 impacts
	in operation:	0° C to + 50° C	0° C to + 50° C
		-20° C to + 60° C	-20° C to + 60° C

GENERAL CHARACTERISTICS

Wire colour code	white/blue
	white/orange
	white/green
	white/brown
	in accordance with IEC 60189 and IEC 60708

Imprint DATWYLER «cable type» «additional text» «batch number» «meter marks»

- Zero halogen, non corrosive gases
- Flame propagation
- Flame spread
- Smoke density
- Power over Ethernet
- EMC
- Segregation class c
- Cat/Class Cat 6 / Class E - limit values as specified by IEC 61156-5 and EN 50288-5-1 guaranteed

Data cable, SF/UTP, Category 6, AWG24
CU 6702 4P

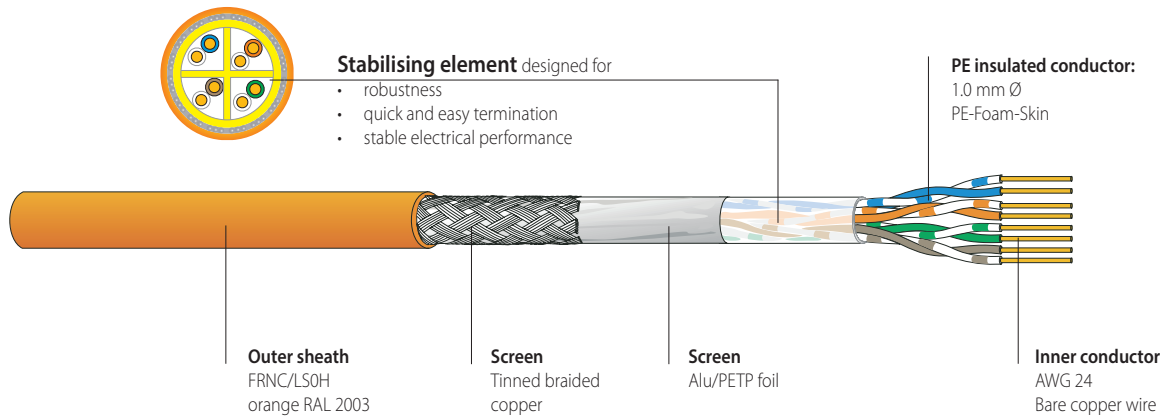

PRODUCT INFORMATION

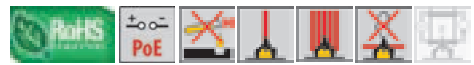

FEATURES

Electrically and mechanically high-quality Cat.6 data cable - fulfils the requirements of ISO/IEC 11801, IEC 61156-5, EN 50173-1 und EN 50288-5-1.
Robust cable design with a very high mechanical stability and reliable electrical performance thanks to the stabilising element.
Excellent shielding effect due to overall foil and copper braid.

Simple, fast and reliable terminations thanks to the special cable stripper **Abi 62**.



Article No. 185640

Tool is applicable for

1. removal of outer sheath
2. removal of stabilising element from pairs

Compatible with all current connecting hardware in accordance with EN 50173 and ISO/IEC 11801.

APPLICATIONS

Data cable for structured premises cabling.
For the transmission of digital and analogue voice, video and data signals.
Suitable for all ICT network applications up to class E applications (250 MHz) in accordance with EN 50173-1 and ISO/IEC 11801.
Applicable for Power over Ethernet (PoE) / PoE+.

VERSIONS

Article No.	Dimension n x n x mm (AWG)	Sheath	Sheath Ø mm	Weight kg/km	Cu weight kg/km	Fire load		PU
						kWh/m	MJ/m	
182943	4 x 2 x 0.54 (AWG24)	FRNC/LS0H ¹⁾	7.4	63.7	27.7	0.25	0.89	1000 m drum

¹⁾ FRNC/LS0H = Flame Retardant Non Corrosive / Low Smoke Zero Halogen

ELECTRICAL CHARACTERISTICS

CATEGORY	5e			6		
Frequency [MHz]	1	4	10	100	250	300
Attenuation [dB/100m]	1.8	3.4	5.1	17.2	26	30
NEXT [dB]	84	75	71	50	43	40
PS NEXT [dB]	81	72	68	47	40	37
ACR-N [dB]	82	72	66	33	17	10
PS-ACR-N [dB]	79	69	63	30	14	7
ACR-F [dB]	90	80	71	42	35	31
PS-ACR-F [dB]	87	77	68	39	32	28
Return loss [dB]	27	30	32	30	25	25

These performance data are typical measured values.

Loop resistance at 20° C: 157 Ω/km
 Mutual capacitance: 50 pF/m
 Impedance at 100 MHz: 100 Ω ±5 Ω
 Transfer impedance at 1/10/30 MHz: < 40/80/180 mΩ/m
 Coupling attenuation (limit curve of critical state - IEC 61156): > 65 dB
 Near end unbalance attenuation LCL at 1-250 MHz: > 40 dB
 Delay Skew: 25 ns/100 m
 NVP: 68 %

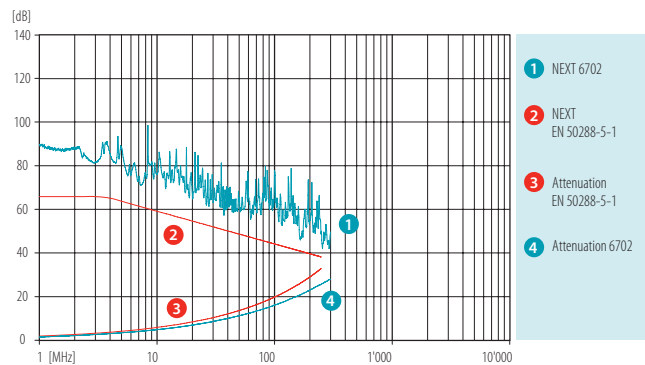

MECHANICAL CHARACTERISTICS

Bending radius during draw-in: ≥ 58 mm
 permanently installed: ≥ 29 mm
 Tensile strength: ≤ 110 N
 Crush resistance: ≥ 3000 N/10 cm
 Impact: ≥ 30 impacts
 Temperature range during installation: 0° C to + 50° C
 in operation: -20° C to + 60° C

GENERAL CHARACTERISTICS

Wire colour code white - blue/blue
 white - orange/orange
 white - green/green
 white - brown/brown
 in accordance with IEC 60189 and IEC 60708 (ring marked)

Imprint DATWYLER «cable type» «additional text» «batch number» «meter marks»

- Zero halogen, non corrosive gases
- Flame propagation
- Flame spread
- Smoke density
- Power over Ethernet
- EMC
- Segregation class c
- Cat/Class Cat 6 / Class E - limit values as specified by IEC 61156-5v and EN 50288-5-1 guaranteed

Data cable, U/FTP, Category 6, AWG23
CU 6002 4P

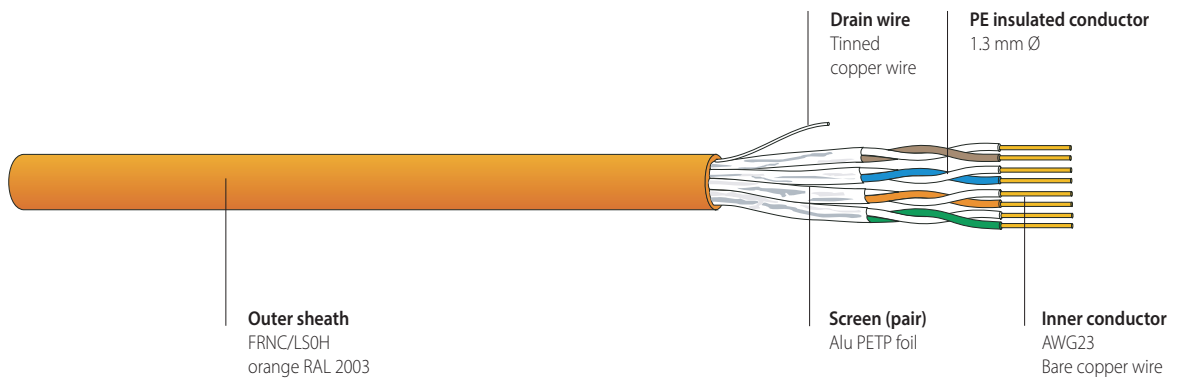

PRODUCT INFORMATION

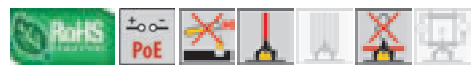

FEATURES

Electrically and mechanically high-quality Cat.6 data cable - fulfils the requirements of ISO/IEC 11801, IEC 61156-5, EN 50173-1 and EN 50288-5-1.
Good shielding effect due to individually screened pairs.
Compatible with all current connecting hardware in accordance with EN 50173 and ISO/IEC 11801.

APPLICATIONS

Data cable for structured premises cabling.
For the transmission of digital and analogue voice, video and data signals.
Suitable for all ICT network applications up to class E applications (250 MHz) in accordance with EN 50173-1 and ISO/IEC 11801.
Applicable for Power over Ethernet (PoE) / PoE+.

VERSIONS

Article No.	Dimension	Sheath	Sheath Ø	Weight	Cu weight	Fire load		PU
	n x n x mm (AWG)					kWh/m	MJ/m	
182936	4 x 2 x 0.55 (AWG 23)	FRNC/LSOH ¹⁾	7.0	47.8	20.0	0.15	0.55	1000 m drum

¹⁾ FRNC/LSOH = Flame Retardant Non Corrosive / Low Smoke Zero Halogen

ELECTRICAL CHARACTERISTICS

CATEGORY	5e		6		
Frequency [MHz]	1	4	10	100	250
Attenuation [dB/100m]	2.1	3.8	5.9	19.8	30
NEXT [dB]	93	93	93	93	83
PS NEXT [dB]	90	90	90	90	80
ACR-N [dB]	91	89	87	73	53
PS-ACR-N [dB]	88	86	84	70	50
ACR-F [dB]	96	96	96	74	56
PS-ACR-F [dB]	93	93	93	71	53
Return loss [dB]	26	28	30	30	27

These performance data are typical measured values.

Loop resistance at 20° C: 150 Ω/km
 Mutual capacitance: 42 pF/m
 Impedance at 100 MHz: 100 Ω ±5 Ω
 Transfer impedance at 1/10/30 MHz: < 50/100/200 mΩ/m
 Coupling attenuation (limit curve of critical state - IEC 61156): > 55 dB
 Near end unbalance attenuation LCL at 1/10/100 MHz: > 40 dB
 Delay Skew: 5 ns/100 m
 NVP: 79 %

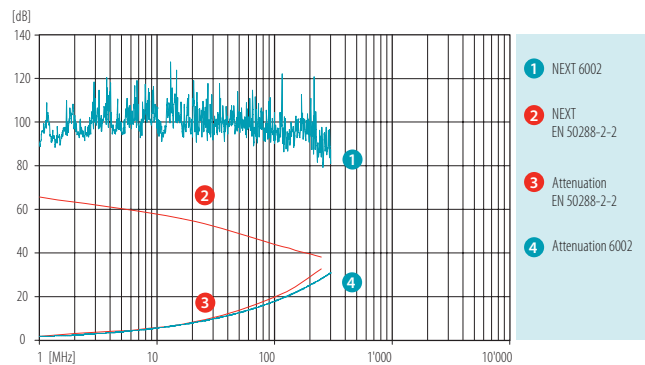

MECHANICAL CHARACTERISTICS

Bending radius during draw-in: ≥ 56 mm
 permanently installed: ≥ 28 mm
 Tensile strength: ≤ 95 N
 Crush resistance: ≥ 1000 N/10 cm
 Impact: ≥ 10 impacts
 Temperature range during installation: 0° C to + 50° C
 in operation: -20° C to + 60° C

GENERAL CHARACTERISTICS

Wire colour code white/blue
 white/orange
 white/green
 white/brown
 in accordance with IEC 60189 and IEC 60708

Imprint DATWYLER «cable type» «additional text» «batch number» «meter marks»

- Zero halogen, non corrosive gases
- Flame propagation
- Smoke density
- Power over Ethernet
- EMC
- Segregation class c
- Cat./Class Cat 6 / Class E - limit values as specified by IEC 61156-5 and EN 50288-5-1 guaranteed

IEC 60754-1/-2, EN 50267-2-1/-2-2 (VDE 0482-267-2-1/-2-2)
 IEC 60332-1-2, EN 60332-1-2 (VDE 0482-332-1-2)
 IEC 61034-1/-2, EN 61034-1/-2 (VDE 0482-1034-1/-2)
 IEEE 802.3af shielded

COPPER DATA CABLES, SHIELDED

Data cable, SF/UTP, Category 5e, AWG24
CU 5502 4P

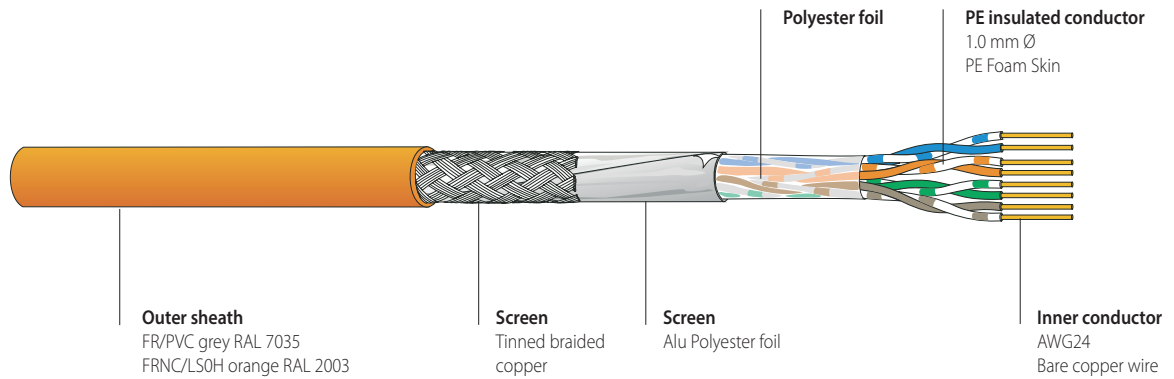

PRODUCT INFORMATION

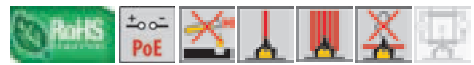

FEATURES

Electrically and mechanically high-quality Cat.5e data cable - fulfils the requirements of ISO/IEC 11801, IEC 61156-5, EN 50173-1 and EN 50288-2-1. Excellent shielding effect due to overall foil and copper braid. Compatible with all current connecting hardware in accordance with EN 50173 and ISO/IEC 11801.

APPLICATIONS

Data cable for structured premises cabling. For the transmission of digital and analogue voice, video and data signals. Suitable for all ICT network applications up to class D applications (100 MHz) in accordance with EN 50173-1 and ISO/IEC 11801. Applicable for Power over Ethernet (PoE) / PoE+.

VERSIONS

Article No.	Dimension n x n x mm (AWG)	Sheath	Sheath Ø mm	Weight kg/km	Cu weight kg/km	Fire load		PU
						kWh/m	MJ/m	
181112	4 x 2 x 0.54 (AWG24)	FR/PVC ¹⁾	6.1	45.1	26.0	0.15	0.55	1000 m drum
181111	4 x 2 x 0.54 (AWG24)	FRNC/LSOH ²⁾	6.1	45.9	26.0	0.13	0.44	1000 m drum

¹⁾ FR/PVC = Flame Retardant / Polyvinyl Chloride

²⁾ FRNC/LSOH = Flame Retardant Non Corrosive / Low Smoke Zero Halogen

Copper

Fibre Optics

Cabinets & Racks

Data Centre

Wireless

Multimedia

General Information

CU 5502 4P 0714/e

ELECTRICAL CHARACTERISTICS

CATEGORY	5e				
Frequency [MHz]	1	4	10	100	250
Attenuation [dB/100m]	1.9	3.6	5.6	18.2	29
NEXT [dB]	75	70	65	44	40
PS NEXT [dB]	72	67	62	41	37
ACR-N [dB]	73	66	59	26	11
PS-ACR-N [dB]	70	63	56	23	8
ACR-F [dB]	84	69	63	41	31
PS-ACR-F [dB]	81	66	60	38	28
Return loss [dB]	27	31	31	28	24

These performance data are typical measured values.

Loop resistance at 20° C: 155 Ω/km
 Mutual capacitance: 43 pF/m
 Impedance at 100 MHz: 100 Ω ±5 Ω
 Transfer impedance at 1/10/30 MHz: < 30/60/170 mΩ/m
 Coupling attenuation (limit curve of critical state - IEC 61156): > 55 dB
 Near end unbalance attenuation LCL: > 40 dB
 Delay Skew: 8 ns/100 m
 NVP: 76 %

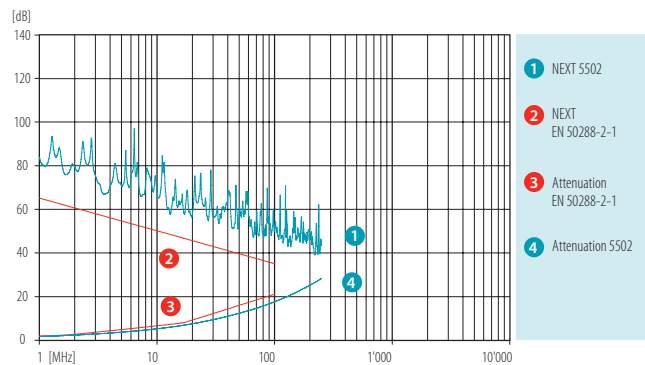

MECHANICAL CHARACTERISTICS

Bending radius (flat side) during draw-in: ≥ 48 mm
 permanently installed: ≥ 24 mm
 Tensile strength: ≤ 91 N
 Crush resistance: ≥ 1000 N/10 cm
 Impact: ≥ 10 impacts
 Temperature range during installation: 0° C to + 50° C
 in operation: -20° C to + 60° C

GENERAL CHARACTERISTICS

Wire colour code white - blue/blue
 white - orange/orange
 white - green/green
 white - brown/brown (ring marked)
 in accordance with IEC 60189 and IEC 60708

Imprint DATWYLER «cable type» «additional text» «batch number» «meter marks»

Zero halogen IEC 60754-1/-2, EN 50267-2-1/-2-2 (VDE 0482-267-2-1/-2-2)
 non corrosive gases - applies to FRNC/LSOH
 Flame propagation IEC 60332-1-2, EN 60332-1-2 (VDE 0482-332-1-2)
 Flame spread IEC 60332-3-24, EN 60332-3-24 - applies to FRNC/LSOH
 Smoke density IEC 61034-1/-2, EN 61034-1/-2 (VDE 0482-1034-1/-2) - applies to FRNC/LSOH

Power over Ethernet IEEE 802.3af
 EMC shielded
 Segregation class c
 Cat./Class Cat 5e / Class D - limit values as specified by IEC 61156-5 and EN 50288-2-1 guaranteed

Data cable, F/UTP, Category 5e, AWG24

CU 5002 4P

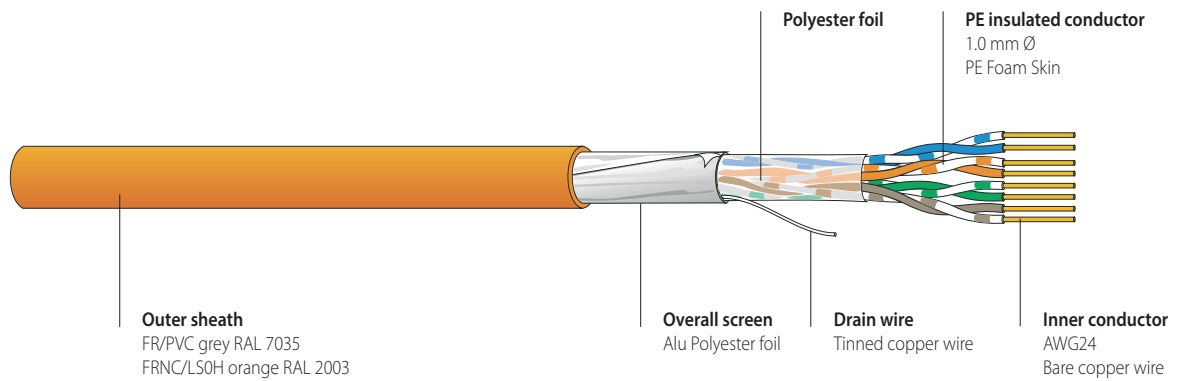

PRODUCT INFORMATION

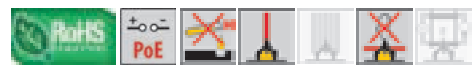

FEATURES

Electrically and mechanically high-quality Cat.5e data cable - fulfils the requirements of ISO/IEC 11801, IEC 61156-5, EN 50173-1 and EN 50288-2-1. Excellent shielding effect due to overall screen foils. Compatible with all current connecting hardware in accordance with EN 50173 and ISO/IEC 11801.

APPLICATIONS

Data cable for structured premises cabling. For the transmission of digital and analogue voice, video and data signals. Suitable for all ICT network applications up to class D applications (100 MHz) in accordance with EN 50173-1 and ISO/IEC 11801. Applicable for Power over Ethernet (PoE) / PoE+.

VERSIONS

Article No.	Dimension n x n x mm (AWG)	Sheath	Sheath Ø mm	Weight kg/km	Cu weight kg/km	Fire load		PU
						kWh/m	MJ/m	
181114	4 x 2 x 0.54 (AWG24)	FR/PVC ¹⁾	6.2	40.0	19.5	0.16	0.56	1000 m drum
181113	4 x 2 x 0.54 (AWG24)	FRNC/LSOH ²⁾	6.0	40.8	19.5	0.14	0.51	1000 m drum

¹⁾ FR/PVC = Flame Retardant / Polyvinyl Chloride

²⁾ FRNC/LSOH = Flame Retardant Non Corrosive / Low Smoke Zero Halogen

ELECTRICAL CHARACTERISTICS

CATEGORY	5e				
Frequency [MHz]	1	4	10	100	250
Attenuation [dB/100m]	1.9	3.6	5.6	18.2	29
NEXT [dB]	75	70	65	44	40
PS NEXT [dB]	72	67	62	41	37
ACR-N [dB]	73	66	59	26	11
PS-ACR-N [dB]	70	63	56	23	8
ACR-F [dB]	84	69	63	41	31
PS-ACR-F [dB]	81	66	60	38	28
Return loss [dB]	27	31	31	28	24

These performance data are typical measured values.

Loop resistance at 20° C: 155 Ω/km
 Mutual capacitance: 43 pF/m
 Impedance at 100 MHz: 100 Ω ±5 Ω
 Transfer impedance at 1/10/30 MHz: < 45/90/190 mΩ/m
 Coupling attenuation (limit curve of critical state - IEC 61156): > 40 dB
 Near end unbalance attenuation LCL: > 40 dB
 Delay Skew: 8 ns/100 m
 NVP: 76 %

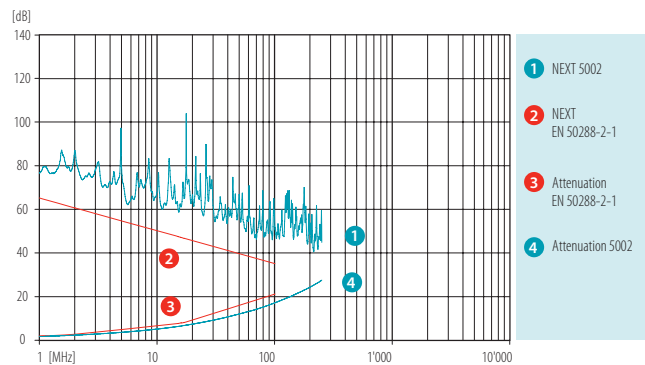

MECHANICAL CHARACTERISTICS

Bending radius (flat side) during draw-in: ≥ 48 mm
 permanently installed: ≥ 24 mm
 Tensile strength: ≤ 91 N
 Crush resistance: ≥ 1000 N/10 cm
 Impact: ≥ 10 impacts
 Temperature range during installation: 0° C to + 50° C
 in operation: -20° C to + 60° C

GENERAL CHARACTERISTICS

Wire colour code white - blue/blue
 white - orange/orange
 white - green/green
 white - brown/brown (ring marked)
 in accordance with IEC 60189 and IEC 60708

Imprint DATWYLER «cable type» «additional text» «batch number» «meter marks»

Zero halogen
 non corrosive gases
 Flame propagation
 Smoke density
 Power over Ethernet
 EMC
 Segregation class
 Cat./Class

IEC 60754-1/-2, EN 50267-2-1/-2-2
 (VDE 0482-267-2-1/-2-2) - applies to FRNC/LS0H
 IEC 60332-1-2, EN 60332-1-2 (VDE 0482-332-1-2)
 IEC 61034-1/-2, EN 61034-1/-2
 (VDE 0482-1034-1/-2) - applies to FRNC/LS0H
 IEEE 802.3af
 shielded
 b
 Cat 5e / Class D - limit values as specified by IEC 61156-5 and EN 50288-2-1 guaranteed

Flexible data cable, S/FTP, Category 8.2, AWG26

CU 8206 4P flex

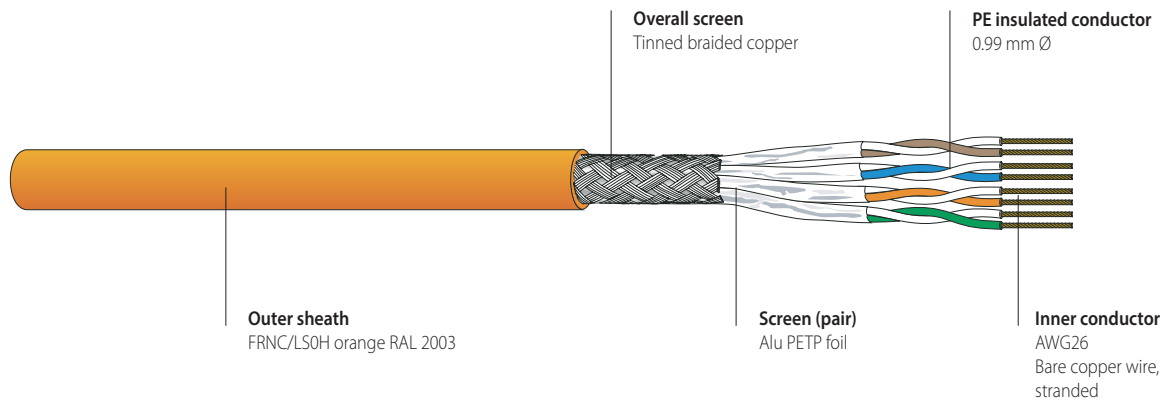

PRODUCT INFORMATION



FEATURES

Electrically and mechanically high-quality Category 8.2 patch cord – exceeds the requirements of ISO/IEC 11801, IEC 61156-6, EN 50173-1, EN 50288-4-2 and IEC 46C/1002/CD (draft).
 Excellent shielding effect due to individually screened pairs and overall copper braid.
 Compact cable design.
 Easy wire identification and termination due to different coloured wires.
 Compatible with all current connecting hardware in accordance with EN 50173 and ISO/IEC 11801.

APPLICATIONS

Patch cord in patch panels and as equipment connection cable.
 For the transmission of digital and analogue voice, video and data signals.
 Suitable for all ICT network applications up to 2000 MHz.
 Applicable for Power over Ethernet (PoE / PoE+).

VERSIONS

Article No.	Dimension n x n x mm (AWG)	Sheath	Sheath Ø mm	Weight kg/km	Cu weight kg/km	Fire load		PU
						kWh/m	MJ/m	
192068	4 x 2 x 0,132 (AWG26)	FRNC/LSOH ¹⁾	5.8	39.6	18.1	0.11	0.38	1000 m drum

¹⁾ FRNC/LSOH = Flame Retardant Non Corrosive / Low Smoke Zero Halogen

Flexible data cable, S/FTP, Category 8.2, AWG26

CU 8206 4P flex

ELECTRICAL CHARACTERISTICS

CATEGORY	5e		6	6 _A	7	CATV	7 _A	8.2			
Frequency [MHz]	1	4	10	100	250	500	600	862	1000	1600	2000
Attenuation [dB/10m]	0.26	0.50	0.77	2.56	4.1	5.9	6.5	7.7	8.5	10.8	12.2
NEXT [dB]	103	103	103	103	95	95	94	92	90	85	80
PS NEXT [dB]	100	100	100	100	92	92	91	89	77	82	77
ACR-N [dB/10m]	102	102	102	100	91	89	87	84	81	74	67
PS-ACR-N [dB/10m]	99	99	99	97	88	86	84	81	78	71	64
ACR-F [dB/10m]	100	100	100	100	91	89	87	84	81	74	67
PS-ACR-F [dB/10m]	97	97	97	97	88	86	84	81	78	71	64
Return loss [dB/10m]	28	30	30	30	28	26	25	24	23	20	18

These performance data are typical measured values.

Loop resistance at 20° C: 270 Ω/km
 Mutual capacitance: 43 pF/m
 Impedance at 100 MHz: 100 Ω ±5 Ω
 Transfer impedance at 1/10/30 MHz: 10 mΩ/m
 Coupling attenuation (limit curve of critical state - IEC 61156): > 85 dB
 Near end unbalance attenuation LCL: > 40 dB
 Delay skew: 4 ns/100 m
 NVP: 78 %

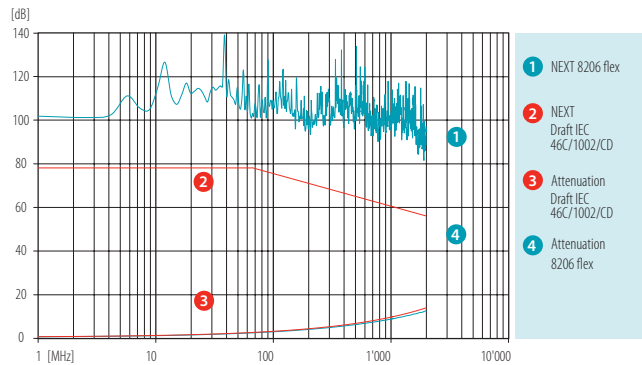

MECHANICAL CHARACTERISTICS

Bending radius: > 20 mm
 Repeated bending: > 1000 cycles
 Tensile strength: ≤ 56 N
 Temperature range: during installation: 0 °C to +50 °C
 in operation: -20 °C to +60 °C

GENERAL CHARACTERISTICS

Wire colour code: white / blue, white / orange, white / green, white / brown according to IEC 60189 and IEC 60708

Imprint: DATWYLER «cable type» «additional text» «batch number» «meter marks»

Zero halogen, non corrosive gases
 Flame propagation
 Smoke density
 Power over Ethernet plus
 EMC
 Cat.

IEC 60754-1/-2, EN 50267-2-1/-2-2 (VDE 0482-267-2-1/-2-2)
 IEC 60332-1-2, EN 60332-1-2 (VDE 0482-332-1-2)
 IEC 61034-1/-2, EN 61034-1/-2 (VDE 0482-1034-1/-2)
 IEEE 802.3af
 shielded
 Cat.8.2
 (IEC 46C/1002/CD, draft)

Flexible data cable, S/FTP, Category 7_A, AWG26

CU 7150 4P flex

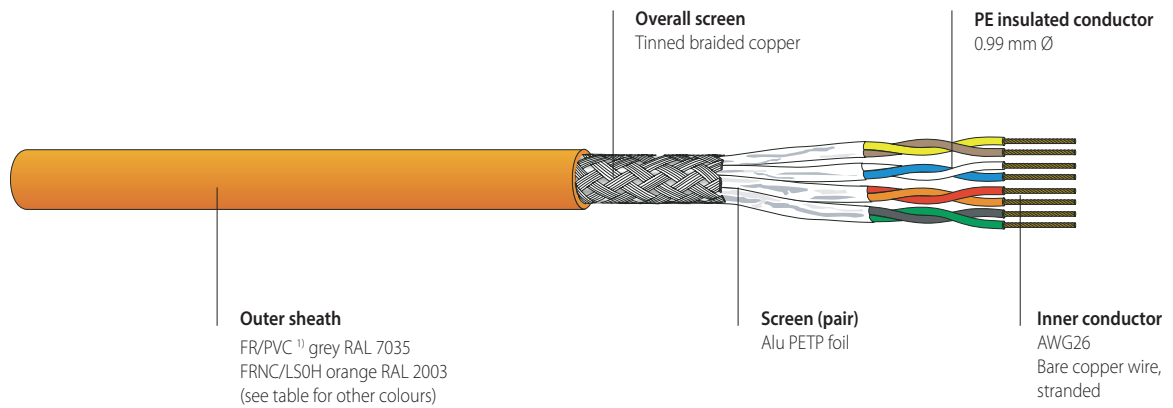

PRODUCT INFORMATION

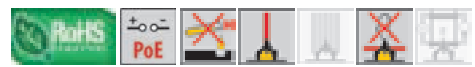

FEATURES

Electrically and mechanically excellent Cat.7_A patch cord - exceeds the requirements of ISO/IEC 11801, IEC 61156-6, IEC 61156-8, EN 50173-1, EN 50288-4-2 and prEN 50288-9-2.
 Excellent shielding effect due to individually screened pairs and overall copper braid.
 Easy wire identification and termination due to different coloured wires.
 Compatible with all current connecting hardware in accordance with EN 50173 and ISO/IEC 11801.
 Optimised for RJ45 connecting systems.
 Differently coloured sheaths facilitate clearly arranged installations and visual differentiation of services.

APPLICATIONS

As patch cord in patch panels and as equipment connection cable.
 For the transmission of digital and analogue voice, video and data signals.
 For flexible workstation cabling with long patch cords.
 Especially suitable for CP (Consolidation Point) applications.
 Suitable for all ICT network applications up to class F_A applications (1000 MHz) in accordance with EN 50173-1 and ISO/IEC 11801.
 Optimized for the transmission of broadband signals (such as cable TV) in accordance with IEC 15018.
 Applicable for Power over Ethernet (PoE) / PoE+.

VERSIONS

Article No.	Colour	Dimension n x n x mm ² (AWG)	Sheath	Sheath Ø mm	Weight kg/km	Cu weight kg/km	Fire load		PU
							kWh/m	MJ/m	
191410	grey	4 x 2 x 0.132 (AWG26)	FRNC/LSOH ²⁾	5.8	39.5	18.1	0.11	0.38	1000 m drum
on request	orange	4 x 2 x 0.132 (AWG26)	FRNC/LSOH ²⁾	5.8	39.5	18.1	0.11	0.38	1000 m drum
on request	black	4 x 2 x 0.132 (AWG26)	FRNC/LSOH ²⁾	5.8	39.5	18.1	0.11	0.38	1000 m drum
on request	green	4 x 2 x 0.132 (AWG26)	FRNC/LSOH ²⁾	5.8	39.5	18.1	0.11	0.38	1000 m drum
on request	yellow	4 x 2 x 0.132 (AWG26)	FRNC/LSOH ²⁾	5.8	39.5	18.1	0.11	0.38	1000 m drum
on request	red	4 x 2 x 0.132 (AWG26)	FRNC/LSOH ²⁾	5.8	39.5	18.1	0.11	0.38	1000 m drum
on request	blue	4 x 2 x 0.132 (AWG26)	FRNC/LSOH ²⁾	5.8	39.5	18.1	0.11	0.38	1000 m drum

PVC versions available on request

¹⁾ FR/PVC = Flame Retardant / Polyvinyl Chloride

²⁾ FRNC/LSOH = Flame Retardant Non Corrosive / Low Smoke Zero Halogen

ELECTRICAL CHARACTERISTICS

CATEGORY	5e		6	6 _A	7	CATV	7 _A			
Frequency [MHz]	1	4	10	100	250	500	600	862	1000	1200
Attenuation [dB/10m]	0.25	0.49	0.76	2.55	4.10	5.90	6.50	7.7	8.50	9.20
NEXT [dB]	100	100	100	100	95	92	90	90	90	90
PS NEXT [dB]	97	97	97	97	92	89	87	87	87	87
ACR-N [dB/10m]	100	99	99	97	91	86	83	82	81	80
PS-ACR-N [dB/10m]	97	96	96	94	88	83	80	79	78	77
ACR-F [dB/10m]	100	99	99	97	95	91	88	87	86	85
PS-ACR-F [dB/10m]	97	96	96	94	92	88	85	84	83	82
Return loss [dB]	26	32	35	30	27	24	23	21	20	19

These performance data are typical measured values.

Loop resistance at 20° C: 270 Ω/km
 Mutual capacitance: 43 pF/m
 Impedance at 100 MHz: 100 Ω ±5 Ω
 Transfer impedance: 10 mΩ/m
 Coupling attenuation (limit curve of critical state - IEC 61156): > 70 dB
 Near end unbalance attenuation LCL at 1-600 MHz: > 40 dB
 Delay Skew: 4 ns/100 m
 NVP: 78 %

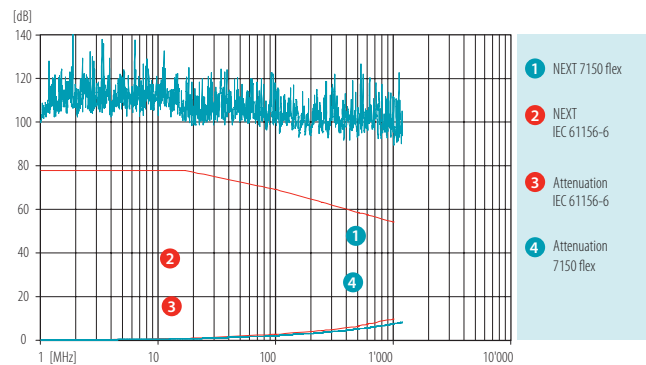

MECHANICAL CHARACTERISTICS

Bending radius: ≥ 20 mm
 Repeated bending: ≥ 1000 cycles
 Tensile strength: ≤ 56 N
 Temperature range: during installation: 0° C to +50° C
 in operation: -20° C to +60° C

GENERAL CHARACTERISTICS

Wire colour code: white /blue, red/orange, black/green, yellow/brown, in accordance with IEC 60189 and IEC 60708

Imprint: DATWYLER «cable type» «additional text» «batch number» «meter marks»

Zero halogen, non corrosive gases, Flame propagation, Smoke density, Power over Ethernet, EMC, Segregation class, Cat./Class

IEC 60754-1/-2, EN 50267-2-1/-2-2 (VDE 0482-267-2-1/-2-2) - applies to FRNC/LS0H
 IEC 60332-1-2, EN 60332-1-2 (VDE 0482-332-1-2)
 IEC 61034-1/-2, EN 61034-1/-2 (VDE 0482-1034-1/-2) - applies to FRNC/LS0H
 IEEE 802.3af shielded
 c
 Cat 7_A / Class F_A - limit values as specified by IEC 61156-6, IEC 61156-8, EN 50288-4-2 and EN 50288-9-2 guaranteed

Flexible data cable, S/FTP, Category 7, AWG26

CU 7702 4P flex

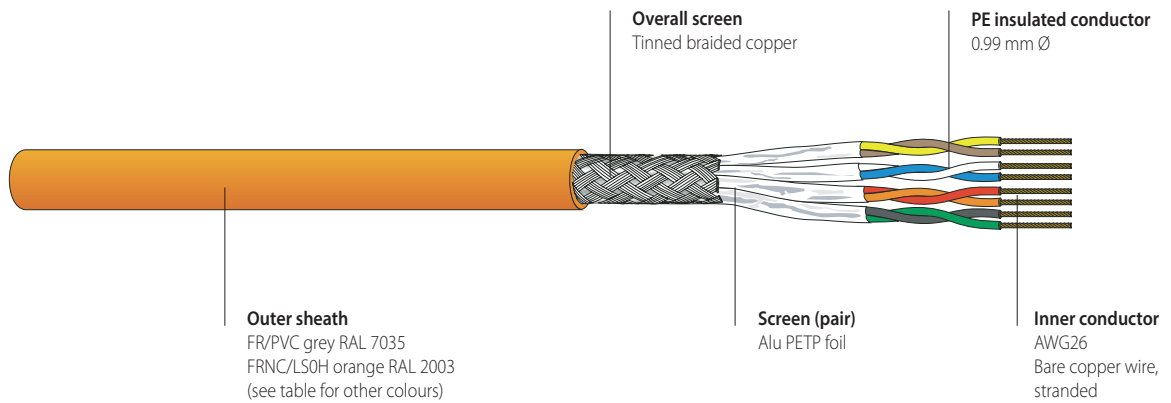

PRODUCT INFORMATION

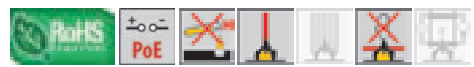

FEATURES

Electrically and mechanically excellent Cat.7 patch cord - exceeds the requirements of ISO/IEC 11801, IEC 61156-6, EN 50173-1 and EN 50288-4-2.
 Excellent shielding effect due to individually screened pairs and overall copper braid.
 Easy wire identification and termination due to different coloured wires.
 Compatible with all current connecting hardware in accordance with EN 50173, ISO/IEC 11801 and 60603-x.

APPLICATIONS

As patch cord in patch panels and as equipment connection cable, especially suitable for CP (Consolidation Point) applications.
 For the transmission of digital and analogue voice, video and data signals.
 Suitable for all ICT network applications up to class F applications (600 MHz) in accordance with EN 50173-1 and ISO/IEC 11801.
 Optimized for the transmission of broadband signals (such as cable TV) in accordance with IEC 15018.
 Applicable for Power over Ethernet (PoE) / PoE+.

VERSIONS

Article No.	Colour	Dimension n x n x mm ² (AWG)	Sheath	Sheath Ø mm	Weight kg/km	Cu weight kg/km	Fire load kWh/m MJ/m		PU
179500	grey	4 x 2 x 0.132 (AWG26)	FR/PVC ¹⁾	5.8	38.8	18.1	0.13	0.48	1000 m drum
181146	grey	4 x 2 x 0.132 (AWG26)	FRNC/LSOH ²⁾	5.8	39.5	18.1	0.11	0.38	1000 m drum
182784	orange	4 x 2 x 0.132 (AWG26)	FRNC/LSOH ²⁾	5.8	39.5	18.1	0.11	0.38	1000 m drum
182871	black	4 x 2 x 0.132 (AWG26)	FRNC/LSOH ²⁾	5.8	39.5	18.1	0.11	0.38	1000 m drum
182872	green	4 x 2 x 0.132 (AWG26)	FRNC/LSOH ²⁾	5.8	39.5	18.1	0.11	0.38	1000 m drum
181243	yellow	4 x 2 x 0.132 (AWG26)	FRNC/LSOH ²⁾	5.8	39.5	18.1	0.11	0.38	1000 m drum
182773	red	4 x 2 x 0.132 (AWG26)	FRNC/LSOH ²⁾	5.8	39.5	18.1	0.11	0.38	1000 m drum
182873	blue	4 x 2 x 0.132 (AWG26)	FRNC/LSOH ²⁾	5.8	39.5	18.1	0.11	0.38	1000 m drum
185655	purple	4 x 2 x 0.132 (AWG26)	FRNC/LSOH ²⁾	5.8	39.5	18.1	0.11	0.38	1000 m drum
188440	white	4 x 2 x 0.132 (AWG26)	FRNC/LSOH ²⁾	5.8	39.5	18.1	0.11	0.38	1000 m drum

PVC versions available on request

¹⁾ FR/PVC = Flame Retardant / Polyvinyl Chloride

²⁾ FRNC/LSOH = Flame Retardant Non Corrosive / Low Smoke Zero Halogen

Flexible data cable, S/FTP, Category 7, AWG26

CU 7702 4P flex

ELECTRICAL CHARACTERISTICS

CATEGORY	5e		6	6 _A	7		800	862	
Frequency [MHz]	1	4	10	100	250	500	600	800	862
Attenuation [dB/10m]	0.26	0.50	0.79	2.67	4.30	6.20	6.71	7.90	8.30
NEXT [dB]	100	100	100	100	95	92	90	90	90
ACR-N [dB/10m]	97	97	97	97	92	89	87	87	87
PS-ACR-N [dB/10m]	100	99	99	97	91	86	83	82	82
ACR-F [dB/10m]	97	96	96	94	88	83	80	79	79
PS-ACR-F [dB/10m]	100	99	99	97	95	91	88	87	87
PS ELFEXT [dB]	97	96	96	94	92	88	85	84	84
Return loss [dB]	26	32	35	30	27	24	23	21	21

These performance data are typical measured values.

Loop resistance at 20° C: 270 Ω/km
 Mutual capacitance: 43 pF/m
 Impedance at 100 MHz: 100 Ω ±5 Ω
 Transfer impedance: 10 mΩ/m
 Coupling attenuation (limit curve of critical state - IEC 61156): > 70 dB
 Near end unbalance attenuation LCL at 1-600 MHz: > 40 dB
 Delay Skew: 4 ns/100 m
 NVP: 78 %

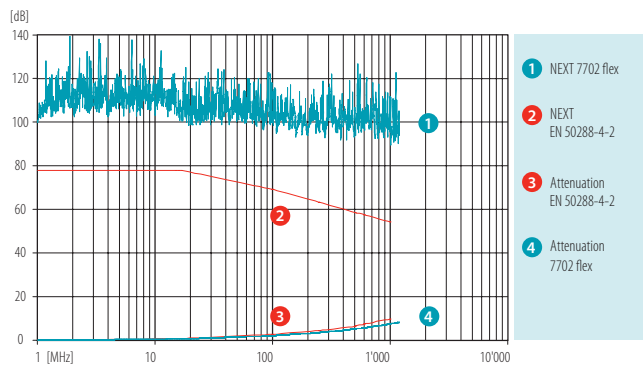

MECHANICAL CHARACTERISTICS

Bending radius: ≥ 20 mm
 Repeated bending: ≥ 1000 cycles
 Tensile strength max.: 56 N
 Crush resistance max.: 600 N / 10 cm
 Temperature range: during installation: 0° C to +50° C
 in operation: -20° C to +60° C

GENERAL CHARACTERISTICS

Wire colour code: white /blue, red/orange, black/green, yellow/brown
 in accordance with IEC 60189 and IEC 60708

Imprint: DATWYLER «cable type» «additional text» «batch number» «meter marks»

- Zero halogen
- non corrosive gases
- Flame propagation
- Smoke density
- Power over Ethernet
- EMC
- Segregation class
- Cat/Class

IEC 60754-1/-2, EN 50267-2-1/-2-2 (VDE 0482-267-2-1/-2-2) - applies to FRNC/LSOH
 IEC 60332-1-2, EN 60332-1-2 (VDE 0482-332-1-2)
 IEC 61034-1/-2, EN 61034-1/-2 (VDE 0482-1034-1/-2) - applies to FRNC/LSOH
 IEEE 802.3af shielded
 c
 Cat 7 / Class F - limit values as specified by IEC 61156-6 and EN 50288-4-2 guaranteed

Industrial flexible data cable, S/FTP, Category 7, AWG26

CU 7702 4P flex Industrial PUR

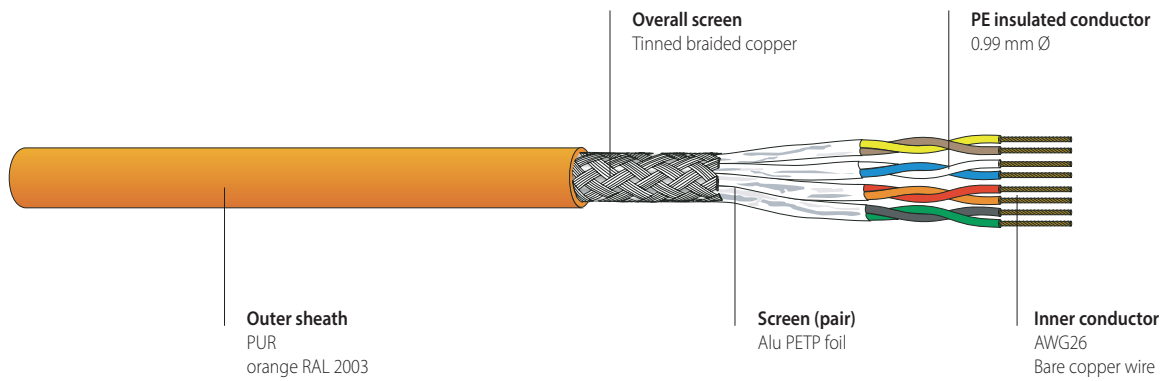

PRODUCT INFORMATION



FEATURES

Electrically and mechanically excellent Cat.7 patch cord with PUR sheath - exceeds the requirements of ISO/IEC 11801, IEC 61156-6, EN 50173-1 and EN 50288-4-2.
 Excellent shielding effect due to individually screened pairs and overall copper braid.
 Easy wire identification and termination due to different coloured wires.
 Compatible with all current connecting hardware in accordance with EN 50173 and ISO/IEC 11801.
 Compatible with Datwyler IP67 RJ45 plug.

APPLICATIONS

As patch cord in patch panels and as equipment connection cable - designed for use in industrial areas.
 Oil resistant.
 For transmission of digital and analogue voice, video and data signals.
 For flexible workstation cabling with long patch cords.
 Especially suitable for CP (Consolidation Point) applications.
 Suitable for all ICT network applications up to class F applications (600 MHz) in accordance with EN 50173-1 and ISO/IEC 11801.
 Applicable for Power over Ethernet (PoE) / PoE+.

VERSIONS

Article No.	Dimension n x n x mm (AWG)	Sheath	Sheath Ø mm	Weight kg/km	Cu weight kg/km	Fire load		PU
						kWh/m	MJ/m	
187688	4 x 2 x 0.132 (AWG26)	PUR ¹⁾	6.4	52.4	18.1	0.15	0.54	1000 m drum

¹⁾ PUR = Polyurethane

Industrial flexible data cable, S/FTP, Category 7, AWG26

CU 7702 4P flex Industrial PUR

ELECTRICAL CHARACTERISTICS

CATEGORY	5e		6	6 _A	7		
Frequency [MHz]	1	4	10	100	250	500	600
Attenuation [dB/10m]	0.26	0.50	0.79	2.67	4.30	6.20	6.71
NEXT [dB]	100	100	100	100	95	92	90
PS NEXT [dB]	97	97	97	97	92	89	87
ACR-N [dB/10m]	100	99	99	97	91	86	83
PS-ACR-N [dB/10m]	97	96	96	94	88	83	80
ACR-F [dB/10m]	100	99	99	97	95	91	88
PS-ACR-F [dB/10m]	97	96	96	94	92	88	85
Return loss [dB]	26	32	35	30	27	24	23

These performance data are typical measured values.

Loop resistance at 20° C: 270 Ω/km
 Mutual capacitance: 43 pF/m
 Impedance at 100 MHz: 100 Ω ±5 Ω
 Transfer impedance: 10 mΩ/m
 Coupling attenuation (limit curve of critical state - IEC 61156): > 70 dB
 Near end unbalance attenuation LCL at 1-600 MHz: > 40 dB
 Delay Skew: 4 ns/100 m
 NVP: 78 %

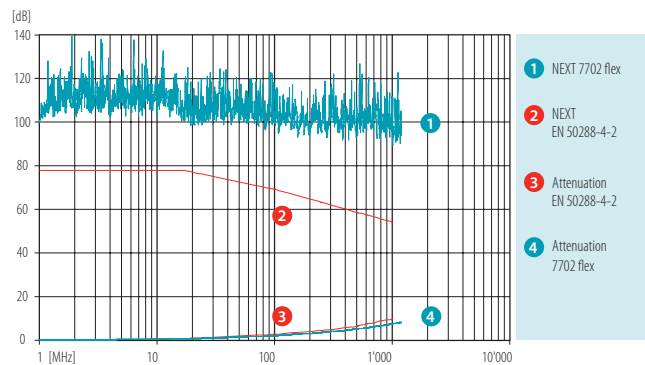

MECHANICAL CHARACTERISTICS

Bending radius: ≥ 34 mm
 Repeated bending: ≥ 1000 cycles
 Tensile strength: on request
 Temperature range:
 during installation: 0° C to +50° C
 in operation: -30° C to + 60° C

GENERAL CHARACTERISTICS

Wire colour code: white /blue, red/orange, black/green, yellow/brown, in accordance with IEC 60189 and IEC 60708

Imprint: DATWYLER «cable type» «additional text» «batch number» «meter marks»

- Zero halogen, non corrosive gases: IEC 60754-1/-2, EN 50267-2-1/-2-2 (VDE 0482-267-2-1/-2-2)
- Flame propagation: IEC 60332-1-2, EN 60332-1-2 (VDE 0482-332-1-2)
- Oil-resistant: EN 60811-2-1
- Power over Ethernet: IEEE 802.3af
- EMC: shielded
- Segregation class: c
- Cat./Class: Cat 7 / Class F - limit values as specified by IEC 61156-6 and EN 50288-4-2 guaranteed

Flexible data cable, S/FTP, Category 7, AWG26

CU 1P flex Multimedia

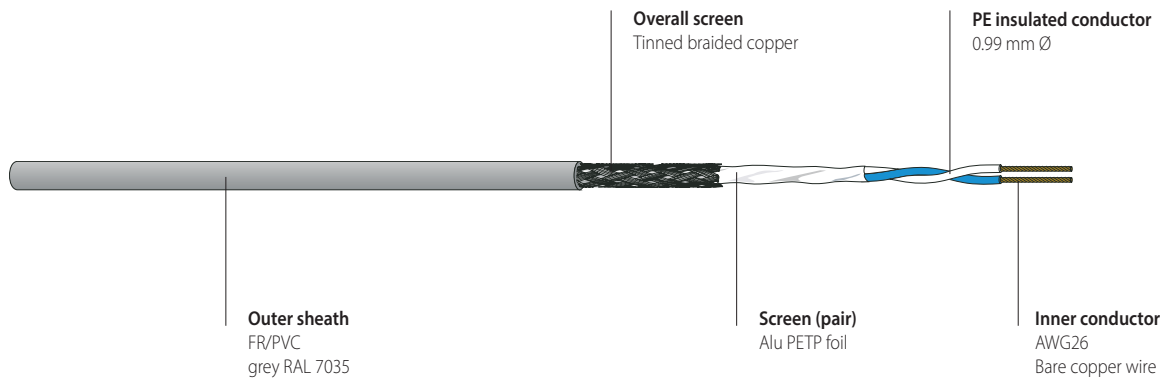

PRODUCT INFORMATION

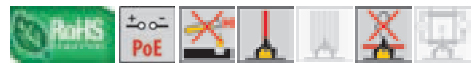

FEATURES

Electrically and mechanically excellent 1 pair Cat.7 patch cord - exceeds the requirements of ISO/IEC 11801, IEC 61156-6, EN 50173-1 and EN 50288-4-2.
 Excellent shielding effect due to individually screened pairs and overall copper braid.
 Easy wire identification and termination due to different coloured wires.
 Compatible with all current connecting hardware in accordance with EN 50173 and ISO/IEC 11801.
 Optimised for RJ45 connecting systems.

APPLICATIONS

As patch cord in patch panels and as equipment connection cable.
 For the transmission of digital and analogue voice, video and data signals.
 For flexible workstation cabling with long patch cables.
 Suitable for all 1 pair ICT network applications up to class F applications (600 MHz) in accordance with EN 50173-1 and ISO/IEC 11801.

VERSIONS

Article No.	Dimension n x n x mm (AWG)	Sheath	Sheath Ø mm	Weight kg/km	Cu weight kg/km	Fire load		PU
						kWh/m	MJ/m	
182884	1 x 2 x 0.132 (AWG26)	FRNC/LSOH ¹⁾	3.5	18.4	9.5	0.05	0.18	1000 m drum

¹⁾ FRNC/LSOH = Flame Retardant Non Corrosive / Low Smoke Zero Halogen

Flexible data cable, S/FTP, Category 7, AWG26

CU 1P flex Multimedia

ELECTRICAL CHARACTERISTICS

CATEGORY	5e		6	6 _A	7						
Frequency [MHz]	1	4	10	100	250	500	600	800	862	1000	1200
Attenuation [dB/10m]	0.26	0.50	0.79	2.67	4.30	6.20	6.71	7.90	8.30	8.90	9.90
NEXT [dB]	100	100	100	100	95	92	90	90	90	90	90
ACR-N [dB/10m]	100	99	99	97	91	86	83	82	82	81	80
PS-ACR-F [dB/10m]	100	99	99	97	95	91	88	87	87	86	85
Return loss [dB]	26	32	35	30	27	24	23	21	21	20	19

These performance data are typical measured values.

Loop resistance at 20° C: 270 Ω/km
 Mutual capacitance: 43 pF/m
 Impedance at 100 MHz: 100 Ω ±5 Ω
 Transfer impedance: 10 mΩ/m
 Coupling attenuation (limit curve of critical state - IEC 61156): > 70 dB
 Near end unbalance attenuation LCL at 1-600 MHz: > 40 dB
 Delay Skew: 4 ns/100 m
 NVP: 78 %

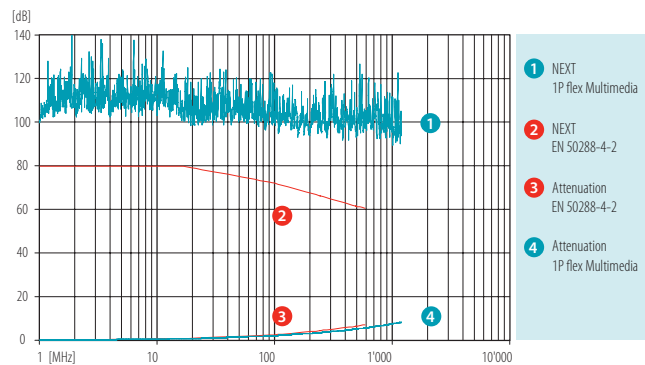

MECHANICAL CHARACTERISTICS

Bending radius: ≥ 28 mm
 Repeated bending: ≥ 1000 cycles
 Tensile strength: ≤ 14 N
 Temperature range: during installation: 0° C to +50° C
 in operation: -20° C to +60° C

GENERAL CHARACTERISTICS

Wire colour code: 1P: white/blue
 Imprint: DATWYLER «cable type» «additional text» «batch number» «meter marks»
 Zero halogen
 non corrosive gases
 Flame propagation
 Smoke density
 Power over Ethernet
 EMC
 Segregation class
 Cat./Class
 IEC 60754-1/-2, EN 50267-2-1/-2-2 (VDE 0482-267-2-1/-2-2)
 IEC 60332-1-2, EN 60332-1-2 (VDE 0482-332-1-2)
 IEC 61034-1/-2, EN 61034-1/-2 (VDE 0482-1034-1/-2)
 IEEE 802.3af
 shielded
 c
 Cat 7 / Class F - limit values as specified by IEC 61156-6 and EN 50288-4-2 guaranteed

Flexible data cable, S/FTP, Category 7, AWG26

CU 2P flex Multimedia

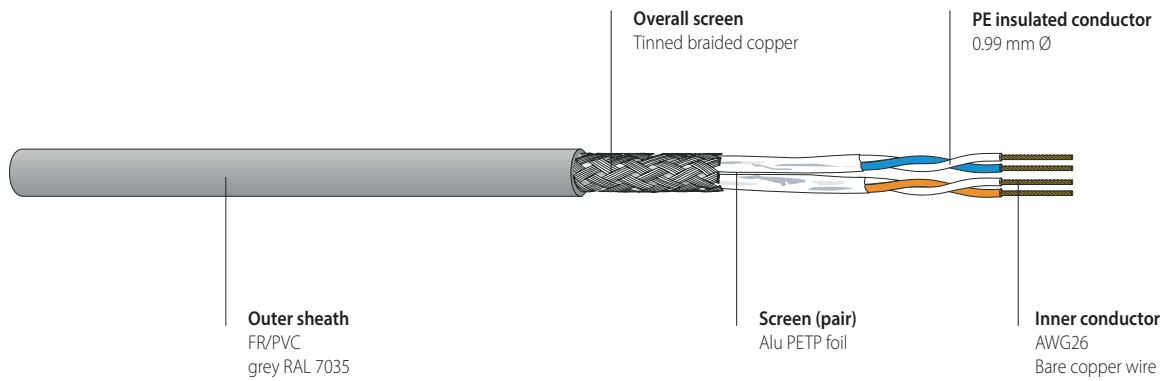

PRODUCT INFORMATION

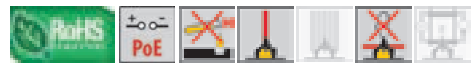

FEATURES

Electrically and mechanically excellent 2 pair Cat.7 patch cord - exceeds the requirements of ISO/IEC 11801, IEC 61156-6, EN 50173-1 and EN 50288-4-2.
 Excellent shielding effect due to individually screened pairs and overall copper braid.
 Easy wire identification and termination due to different coloured wires.
 Compatible with all current connecting hardware in accordance with EN 50173 and ISO/IEC 11801.
 Optimised for RJ45 connecting systems.

APPLICATIONS

As patch cord in patch panels and as equipment connection cable.
 For the transmission of digital and analogue voice, video and data signals.
 For flexible workstation cabling with long patch cables.
 Suitable for all 2 pair ICT network applications up to class F applications (600 MHz) in accordance with EN 50173-1 and ISO/IEC 11801.

VERSIONS

Article No.	Dimension n x n x mm (AWG)	Sheath	Sheath Ø mm	Weight kg/km	Cu weight kg/km	Fire load		PU
						kWh/m	MJ/m	
182885	2 x 2 x 0.132 (AWG26)	FRNC/LSOH ¹⁾	5.0	28.8	12.0	0.09	0.35	1000 m drum

¹⁾ FRNC/LSOH = Flame Retardant Non Corrosive / Low Smoke Zero Halogen

Flexible data cable, S/FTP, Category 7, AWG26

CU 2P flex Multimedia

ELECTRICAL CHARACTERISTICS

CATEGORY	5e		6	6 _A	7						
Frequency [MHz]	1	4	10	100	250	500	600	800	862	1000	1200
Attenuation [dB/10m]	0.26	0.50	0.79	2.67	4.30	6.20	6.71	7.90	8.30	8.90	9.90
NEXT [dB]	100	100	100	100	95	92	90	90	90	90	90
ACR-N [dB/10m]	100	99	99	97	91	86	83	82	82	81	80
PS-ACR-F [dB/10m]	100	99	99	97	95	91	88	87	87	86	85
Return loss [dB]	26	32	35	30	27	24	23	21	21	20	19

These performance data are typical measured values.

Loop resistance at 20° C: 270 Ω/km
 Mutual capacitance: 43 pF/m
 Impedance at 100 MHz: 100 Ω ±5 Ω
 Transfer impedance: 10 mΩ/m
 Coupling attenuation (limit curve of critical state - IEC 61156): > 70 dB
 Near end unbalance attenuation LCL at 1-600 MHz: > 40 dB
 Delay Skew: 4 ns/100 m
 NVP: 78 %

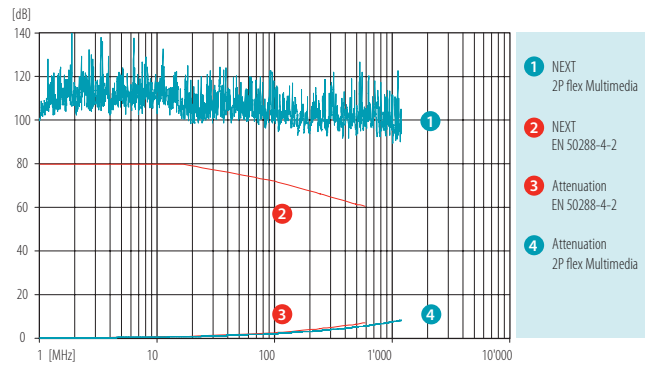

MECHANICAL CHARACTERISTICS

Bending radius: ≥ 28 mm
 Repeated bending: ≥ 1000 cycles
 Tensile strength: ≤ 18 N
 Temperature range: during installation: 0° C to +50° C
 in operation: -20° C to +60° C

GENERAL CHARACTERISTICS

Wire colour code: 2P: white/blue, white/orange
 Imprint: DATWYLER «cable type» «additional text» «batch number» «meter marks»
 Zero halogen
 non corrosive gases
 Flame propagation
 Smoke density
 Power over Ethernet
 EMC
 Segregation class
 Cat./Class
 IEC 60754-1/-2, EN 50267-2-1/-2-2 (VDE 0482-267-2-1/-2-2)
 IEC 60332-1-2, EN 60332-1-2 (VDE 0482-332-1-2)
 IEC 61034-1/-2, EN 61034-1/-2 (VDE 0482-1034-1/-2)
 IEEE 802.3af
 shielded
 c
 Cat 7 / Class F - limit values as specified by IEC 61156-6 and EN 50288-4-2 guaranteed

Flexible data cable, S/UTP, Category 5e, AWG26

CU 5502 4P flex

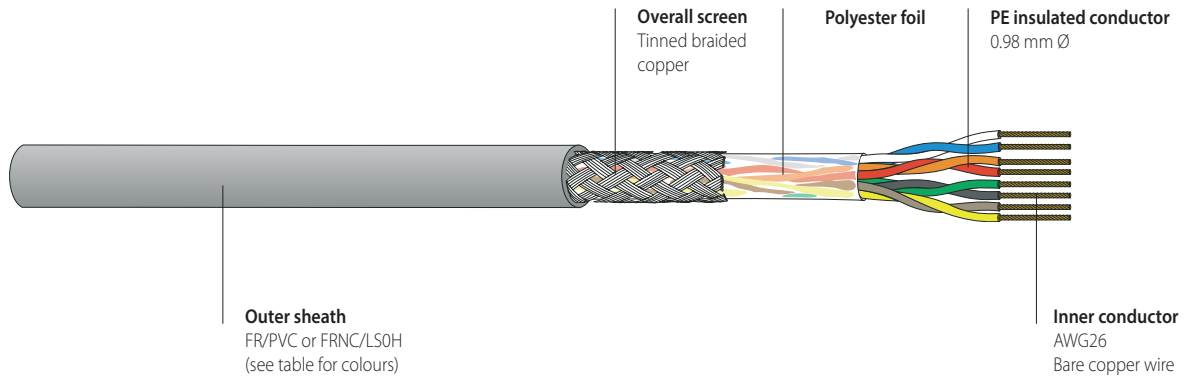

PRODUCT INFORMATION

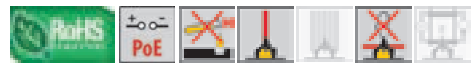

FEATURES

Electrically and mechanically high-quality Cat.5e patch cord - exceeds the requirements of ISO/IEC 11801, IEC 61156-6, EN 50173-1 and EN 50288-2-2.
 Construction optimised for fast and reliable terminations.
 Easy wire identification and termination due to different coloured wires.
 Compatible with all current connecting hardware in accordance with EN 50173 and ISO/IEC 11801.
 Optimised for RJ45 connecting systems.
 Differently coloured sheaths facilitate clearly arranged installations and visual differentiation of services.

APPLICATIONS

As patch cord in patch panels and as equipment connection cable.
 For the transmission of digital and analogue voice, video and data signals.
 Suitable for all ICT network applications up to class D applications (100 MHz) in accordance with EN 50173-1 and ISO/IEC 11801.
 Applicable for Power over Ethernet (PoE) / PoE+.

VERSIONS

Article No.	Colour	Dimension n x n x mm ² (AWG)	Sheath	Sheath Ø mm	Weight kg/km	Cu weight kg/km	Fire load		PU
							kWh/m	MJ/m	
179595	grey	4 x 2 x 0.16 (AWG26)	FR/PVC ¹⁾	5,1	34	23,5	0,11	0,38	1000 m drum
179517	black	4 x 2 x 0.16 (AWG26)	FR/PVC ¹⁾	5,1	34	23,5	0,11	0,38	1000 m drum
179513	green	4 x 2 x 0.16 (AWG26)	FR/PVC ¹⁾	5,1	34	23,5	0,11	0,38	1000 m drum
179514	yellow	4 x 2 x 0.16 (AWG26)	FR/PVC ¹⁾	5,1	34	23,5	0,11	0,38	1000 m drum
179515	red	4 x 2 x 0.16 (AWG26)	FR/PVC ¹⁾	5,1	34	23,5	0,11	0,38	1000 m drum
179516	blue	4 x 2 x 0.16 (AWG26)	FR/PVC ¹⁾	5,1	34	23,5	0,11	0,38	1000 m drum
181101	grey	4 x 2 x 0.16 (AWG26)	FRNC/LSOH ²⁾	5,1	35	23,5	0,09	0,31	1000 m drum
181100	orange	4 x 2 x 0.16 (AWG26)	FRNC/LSOH ²⁾	5,1	35	23,5	0,09	0,31	1000 m drum
181106	black	4 x 2 x 0.16 (AWG26)	FRNC/LSOH ²⁾	5,1	35	23,5	0,09	0,31	1000 m drum
181102	green	4 x 2 x 0.16 (AWG26)	FRNC/LSOH ²⁾	5,1	35	23,5	0,09	0,31	1000 m drum
181103	yellow	4 x 2 x 0.16 (AWG26)	FRNC/LSOH ²⁾	5,1	35	23,5	0,09	0,31	1000 m drum
181104	red	4 x 2 x 0.16 (AWG26)	FRNC/LSOH ²⁾	5,1	35	23,5	0,09	0,31	1000 m drum
181105	blue	4 x 2 x 0.16 (AWG26)	FRNC/LSOH ²⁾	5,1	35	23,5	0,09	0,31	1000 m drum
181107	purple	4 x 2 x 0.16 (AWG26)	FRNC/LSOH ²⁾	5,1	35	23,5	0,09	0,31	1000 m drum
181108	white	4 x 2 x 0.16 (AWG26)	FRNC/LSOH ²⁾	5,1	35	23,5	0,09	0,31	1000 m drum

¹⁾ FR/PVC = Flame Retardant / Polyvinyl Chloride

²⁾ FRNC/LSOH = Flame Retardant Non Corrosive / Low Smoke Zero Halogen

Flexible data cable, S/UTP, Category 5e, AWG26

CU 5502 4P flex

ELECTRICAL CHARACTERISTICS

CATEGORY	5e					
Frequency [MHz]	1	4	10	100	250	300
Attenuation [dB/10m]	0.2	0.5	0.8	3.0	5.2	5.8
NEXT [dB]	75	70	65	42	35	33
PS NEXT [dB]	72	67	62	39	32	30
ACR-N [dB/10m]	74	69	64	39	30	27
PS-ACR-N [dB/10m]	71	66	61	36	27	24
ACR-F [dB/10m]	80	78	75	60	53	50
PS-ACR-F [dB/10m]	77	75	72	57	50	47
Return loss [dB]	24	30	30	28	23	23

These performance data are typical measured values.

Loop resistance at 20° C: 220 Ω/km
 Mutual capacitance: 45 pF/m
 Impedance at 100 MHz: 100 Ω ±5 Ω
 Transfer impedance at 1/10/30 MHz: 20/9/25 mΩ/m
 Coupling attenuation (limit curve of critical state - IEC 61156): > 55 dB
 Near end unbalance attenuation LCL at 1-100 MHz: > 40 dB
 Delay Skew: 15 ns/100 m
 NVP: 75 %

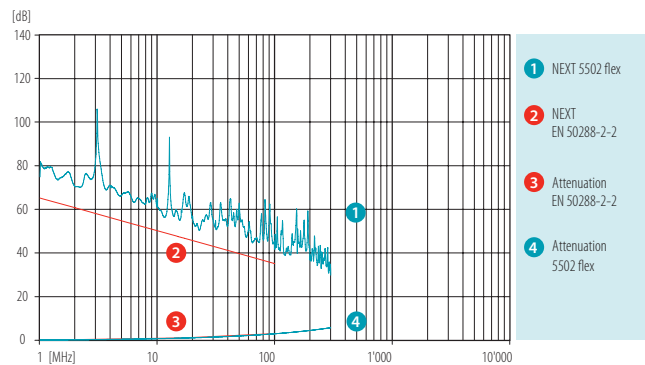

MECHANICAL CHARACTERISTICS

Bending radius: ≥ 20 mm
 Repeated bending: ≥ 1000 cycles
 Tensile strength: ≤ 63 N
 Crush resistance: ≥ 1000 N/10 cm
 Impact: ≥ 10 impacts
 Temperature range during installation: 0° C to + 50° C
 in operation: -20° C to + 60° C

GENERAL CHARACTERISTICS

Wire colour code: white/blue, red/orange, black/green, yellow/brown

Imprint: DATWYLER «cable type» «additional text» «batch number» «meter marks»

Zero halogen
 non corrosive gases
 Flame propagation
 Smoke density

Power over Ethernet
 EMC
 Segregation class
 Cat./Class

IEC 60754-1/-2, EN 50267-2-1/-2-2 (VDE 0482-267-2-1/-2-2) - applies to FRNC/LS0H
 IEC 60332-1-2, EN 60332-1-2 (VDE 0482-332-1-2)
 IEC 61034-1/-2, EN 61034-1/-2 (VDE 0482-1034-1/-2) - applies to FRNC/LS0H
 IEEE 802.3af shielded
 c
 Cat 5e / Class D - limit values as specified by IEC 61156-6 and EN 50288-2-2 guaranteed

Data cable, U/UTP, Category 6, AWG24 CU 662 4P

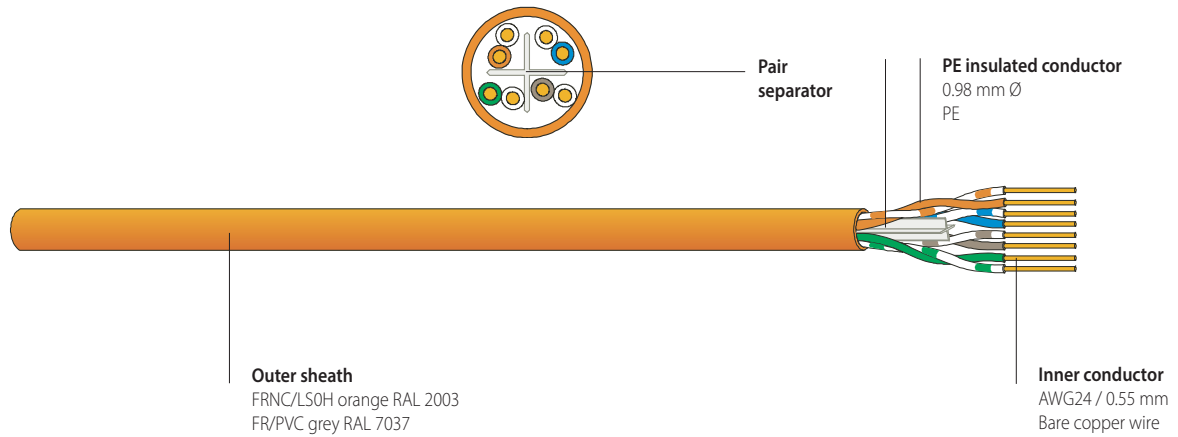

PRODUCT INFORMATION

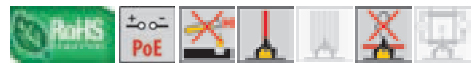

FEATURES

Electrically and mechanically high-quality Cat.6 data cable - fulfils the requirements of ISO/IEC 11801, IEC 61156-5, EN 50173-1 and EN 50288-6-1.
Robust cable design with reliable electrical performance thanks to stabilising element.
Very good NEXT reserve due to cable construction with a pair separator (cross).
Compatible with all current connecting hardware in accordance with EN 50173 and ISO/IEC 11801.

APPLICATIONS

Data cable for structured premises cabling.
For the transmission of digital and analogue voice, video and data signals.
Suitable for all ICT network applications up to class E applications (250 MHz) in accordance with EN 50173-1 and ISO/IEC 11801.
Applicable for Power over Ethernet (PoE) / PoE+.

VERSIONS

Article No.	Dimension n x n x mm (AWG)	Sheath	Sheath Ø mm	Weight kg/km	CU weight kg/km	Fire load		PU
						kWh/m	MJ/m	
240136	4 x 2 x 0.55 (AWG24)	FR/PVC ¹⁾	6.0	39.8	19.4	0.20	0.72	305 m pull quick
240148	4 x 2 x 0.55 (AWG24)	FR/PVC ¹⁾	6.0	39.8	19.4	0.20	0.72	305 m reel in box
240137	4 x 2 x 0.55 (AWG24)	FR/PVC ¹⁾	6.0	39.8	19.4	0.20	0.72	500 m drum
240139	4 x 2 x 0.55 (AWG24)	FR/PVC ¹⁾	6.0	39.8	19.4	0.20	0.72	1000 m drum
240129	4 x 2 x 0.55 (AWG24)	FRNC/LSOH ²⁾	6.0	43	19.4	0.17	0.60	305 m pull quick
240149	4 x 2 x 0.55 (AWG24)	FRNC/LSOH ²⁾	6.0	43	19.4	0.17	0.60	305 m reel in box
240140	4 x 2 x 0.55 (AWG24)	FRNC/LSOH ²⁾	6.0	43	19.4	0.17	0.60	500 m drum
240141	4 x 2 x 0.55 (AWG24)	FRNC/LSOH ²⁾	6.0	43	19.4	0.17	0.60	1000 m drum

¹⁾ FR/PVC = Flame Retardant / Polyvinyl Chloride

²⁾ FRNC/LSOH = Flame Retardant Non Corrosive / Low Smoke Zero Halogen

ELECTRICAL CHARACTERISTICS

CATEGORY	5e		6			
Frequency [MHz]	1	4	10	100	250	300
Attenuation [dB/100m]	1.8	3.6	5.6	18.1	29.1	31.5
NEXT [dB]	85	80	73	59	52	50
PS NEXT [dB]	82	77	70	56	49	47
ACR-N [dB]	83	76	67	41	23	18
PS-ACR-N [dB]	80	73	64	38	20	15
ACR-F [dB]	86	78	67	47	37	33
PS-ACR-F [dB]	83	75	64	45	34	30
Return loss [dB]	27	32	32	30	25	25

These performance data are typical measured values.

Loop resistance at 20° C: 155 Ω/km
 Mutual capacitance: 50 pF/m
 Impedance at 100 MHz: 100 Ω ±5 Ω
 TCL: ≥ 50 db - 10 x lgf
 Delay Skew: 20 ns/100 m
 NVP: 67 %

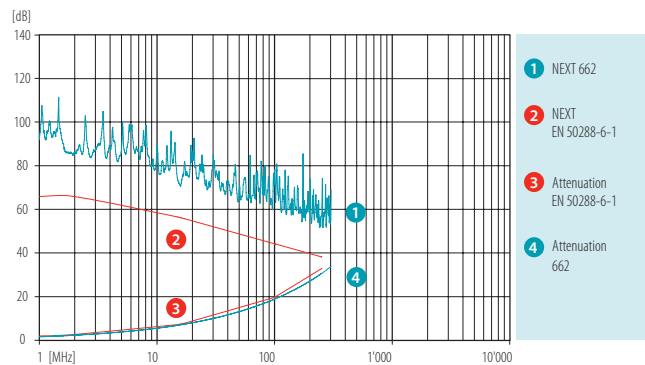

MECHANICAL CHARACTERISTICS

Bending radius
 during draw-in: ≥ 45 mm
 permanently installed: ≥ 22,5 mm
 Tensile strength: ≤ 91 N
 Crush resistance: ≥ 1000 N/10 cm
 Impact: ≥ 10 impacts
 Temperature range
 during installation: 0° C to + 50° C
 in operation: -20° C to + 60° C

GENERAL CHARACTERISTICS

Wire colour code
 white - blue/blue
 white - orange/orange
 white - green/green
 white-brown/brown (ring marked)
 in accordance with IEC 60189 and IEC 60708

Imprint
 DATWYLER «cable type» «additional text» «batch number» «meter marks»

Zero halogen
 non corrosive gases
 Flame propagation
 Smoke density
 Power over Ethernet
 Segregation class
 Cat./Class

IEC 60754-1/-2, EN 50267-2-1/-2-2
 (VDE 0482-267-2-1/-2-2) - applies to FRNC/LSOH
 IEC 60332-1-2, EN 60332-1-2 (VDE 0482-332-1-2)
 IEC 61034-1/-2, EN 61034-1/-2
 (VDE 0482-1034-1/-2) - applies to FRNC/LSOH
 IEEE 802.3af
 b
 Cat 6 / Class E - limit values as specified by IEC 61156-5
 and EN 50288-6-1 guaranteed

Data cable, U/UTP, Category 5e, AWG24

CU 502 4P

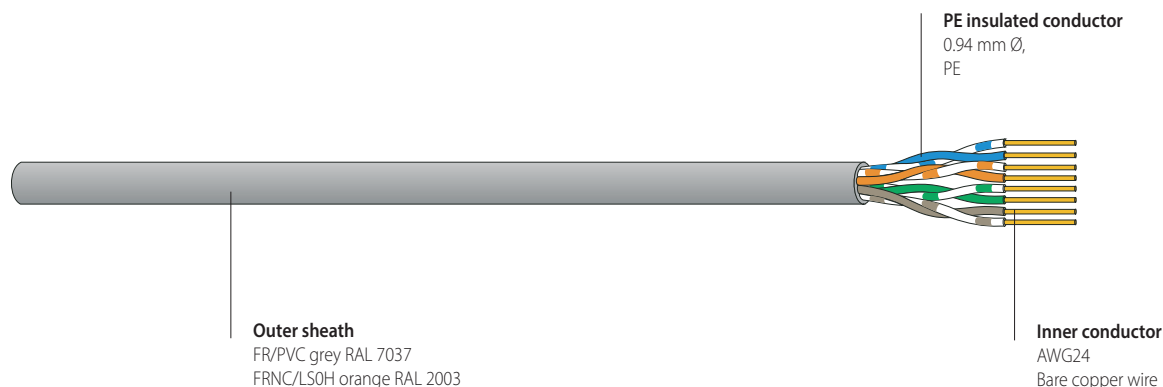

PRODUCT INFORMATION



FEATURES

Electrically and mechanically high-quality Cat 5e cable - fulfils the requirements of ISO/IEC 11801, IEC 61156-5, EN 50173-1 and EN 50288-3-1. Compatible with all current connecting hardware in accordance with EN 50173 and ISO/IEC 11801.

APPLICATIONS

Data cable for structured premises cabling. For the transmission of digital and analogue voice, video and data signals. Suitable for all ICT network applications up to class D applications (100 MHz) in accordance with EN 50173-1 and ISO/IEC 11801. Applicable for Power over Ethernet (PoE) / PoE+.

VERSIONS

Article No.	Dimension n x n x mm (AWG)	Sheath	Sheath Ø mm	Weight kg/km	CU weight kg/km	Fire load		PU
						kWh/m	MJ/m	
240130	4 x 2 x 0.51 (AWG24)	FR/PVC ¹⁾	5.5	33.6	18.1	0.14	0.49	305 m pull quick
240150	4 x 2 x 0.51 (AWG24)	FR/PVC ¹⁾	5.5	33.6	18.1	0.14	0.49	305 m reel in box
240131	4 x 2 x 0.51 (AWG24)	FR/PVC ¹⁾	5.5	33.6	18.1	0.14	0.49	500 m drum
240132	4 x 2 x 0.51 (AWG24)	FR/PVC ¹⁾	5.5	33.6	18.1	0.14	0.49	1000 m drum
240133	4 x 2 x 0.51 (AWG24)	FRNC/LSOH ²⁾	5.5	33.8	18.1	0.12	0.43	305 m pull quick
240151	4 x 2 x 0.51 (AWG24)	FRNC/LSOH ²⁾	5.5	33.8	18.1	0.12	0.43	305 m reel in box
240134	4 x 2 x 0.51 (AWG24)	FRNC/LSOH ²⁾	5.5	33.8	18.1	0.12	0.43	500 m drum
240135	4 x 2 x 0.51 (AWG24)	FRNC/LSOH ²⁾	5.5	33.8	18.1	0.12	0.43	1000 m drum

¹⁾ FR/PVC = Flame Retardant / Polyvinyl Chloride

²⁾ FRNC/LSOH = Flame Retardant Non Corrosive / Low Smoke Zero Halogen

ELECTRICAL CHARACTERISTICS

CATEGORY	5e				
Frequency [MHz]	1	4	10	100	125
Attenuation [dB/100m]	1.9	3.7	6.0	19.8	22.3
NEXT [dB]	71	61	55	40	39
PS NEXT [dB]	68	58	52	37	36
ACR-N [dB]	69	57	49	20	17
PS-ACR-N [dB]	66	54	46	17	14
ACR-F [dB]	76	68	57	34	32
PS-ACR-F [dB]	73	65	54	31	29
Return loss [dB]	26	29	30	27	26

These performance data are typical measured values.

Loop resistance at 20° C: 170 Ω/km
 Mutual capacitance: 50 pF/m
 Impedance at 100 MHz: 100 Ω ±5 Ω
 TCL: ≥ 50 db - 10 x lgf
 NVP: 69 %

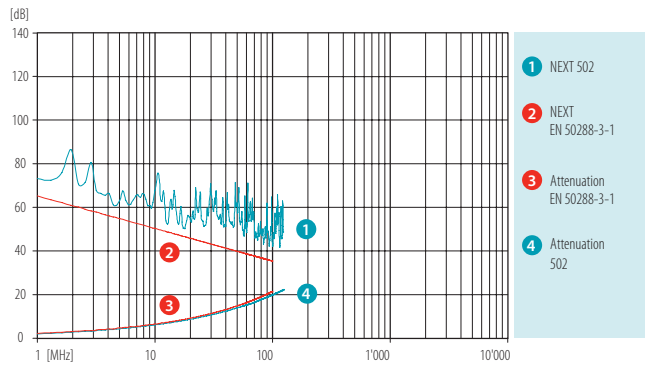

MECHANICAL CHARACTERISTICS

Bending radius
 during draw-in: ≥ 44 mm
 permanently installed: ≥ 22 mm
 ≤ 87 N
 Tensile strength:
 Temperature range
 during installation: 0° C to + 50° C
 in operation: -20° C to + 60° C

GENERAL CHARACTERISTICS

Wire colour code
 white - blue/blue
 white - orange/orange
 white - green/green
 white - brown/brown (ring marked)
 in accordance with IEC 60189 and IEC 60708

Imprint
 DATWYLER «cable type» «additional text» «batch number» «meter marks»

Zero halogen
 non corrosive gases
 Flame propagation
 Smoke density
 IEC 60754-1/-2, EN 50267-2-1/-2-2
 (VDE 0482-267-2-1/-2-2) - applies to FRNC/LS0H
 IEC 60332-1-2, EN 60332-1-2 (VDE 0482-332-1-2)
 IEC 61034-1/-2, EN 61034-1/-2
 (VDE 0482-1034-1/-2) - applies to FRNC/LS0H
 IEEE 802.3af
 b
 Cat 5e / Class D - limit values as specified by IEC 61156-5
 and EN 50288-3-1 guaranteed

Flexible data cable, U/UTP, Category 6, AWG24

CU 602 4P flex

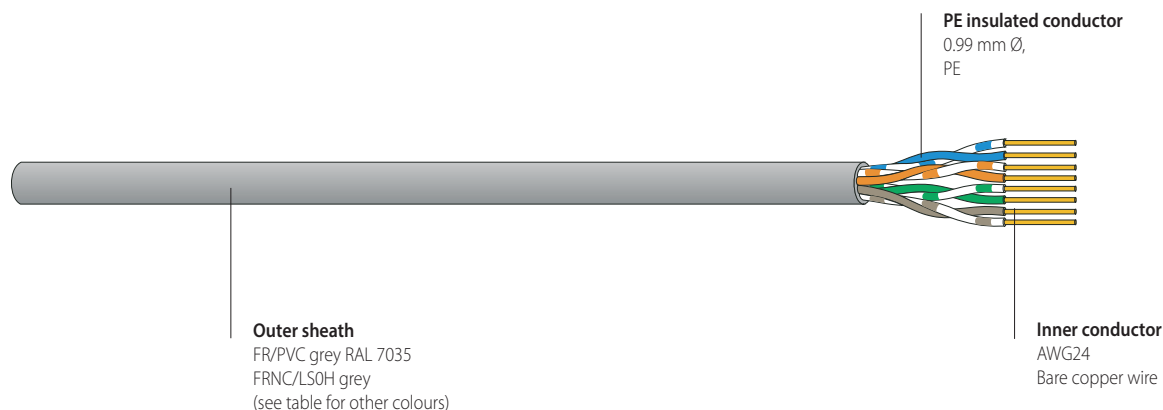

PRODUCT INFORMATION

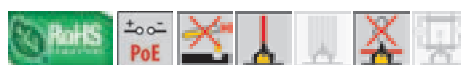

FEATURES

Electrically and mechanically high-quality Cat.6 patch cord - exceeds the requirements of ISO/IEC 11801, IEC 61156-6, EN 50173-1 and EN 50288-6-2.
Construction optimised for fast and reliable terminations.
Easy wire identification and termination due to different coloured wires.
Compatible with all current connecting hardware in accordance with EN 50173 and ISO/IEC 11801.
Optimised for RJ45 connecting systems.
Differently coloured sheaths facilitate clearly arranged installations and visual differentiation of services.

APPLICATIONS

As patch cord in patch panels and equipment connection cable.
For the transmission of digital and analogue voice, video and data signals.
Suitable for all ICT network applications up to class E applications (250 MHz) in accordance with EN 50173-1 and ISO/IEC 11801.
Applicable for Power over Ethernet (PoE) / PoE+.

VERSIONS

Article No.	Colour	Dimension n x n x mm ² (AWG)	Sheath	Sheath Ø mm	Weight kg/km	Cu weight kg/km	Fire load		PU
							kWh/m	MJ/m	
182771	grey	4 x 2 x 0.22 (AWG24)	FR/PVC ¹⁾	5.1	28.1	17.5	0.14	0.49	1000 m drum
182772	grey	4 x 2 x 0.22 (AWG24)	FRNC/LSOH ²⁾	5.1	27.9	17.5	0.11	0.40	1000 m drum
187667	black	4 x 2 x 0.22 (AWG24)	FRNC/LSOH ²⁾	5.1	27.9	17.5	0.11	0.40	1000 m drum
187665	white	4 x 2 x 0.22 (AWG24)	FRNC/LSOH ²⁾	5.1	27.9	17.5	0.11	0.40	1000 m drum
187666	yellow	4 x 2 x 0.22 (AWG24)	FRNC/LSOH ²⁾	5.1	27.9	17.5	0.11	0.40	1000 m drum
182845	blue	4 x 2 x 0.22 (AWG24)	FRNC/LSOH ²⁾	5.1	27.9	17.5	0.11	0.40	1000 m drum
187630	red	4 x 2 x 0.22 (AWG24)	FRNC/LSOH ²⁾	5.1	27.9	17.5	0.11	0.40	1000 m drum

¹⁾ FR/PVC = Flame Retardant / Polyvinyl Chloride

²⁾ FRNC/LSOH = Flame Retardant Non Corrosive / Low Smoke Zero Halogen

Flexible data cable, U/UTP, Category 6, AWG24

CU 602 4P flex

ELECTRICAL CHARACTERISTICS

CATEGORY	5e			6		
Frequency [MHz]	1	4	10	100	250	300
Attenuation [dB/10m]	0.3	0.6	0.9	3.0	5.0	5.5
NEXT [dB]	69	68	62	47	41	40
PS NEXT [dB]	66	65	59	44	38	37
ACR-N [dB/10m]	68	67	61	44	36	34
PS-ACR-N [dB/10m]	65	64	58	41	33	31
ACR-F [dB/10m]	75	69	67	54	48	48
PS-ACR-F [dB/10m]	72	66	64	51	45	45
Return loss [dB]	24	30	30	28	23	23

These performance data are typical measured values.

Loop resistance at 20° C: 180 Ω/km
 Mutual capacitance: 52 pF/m
 Impedance at 100 MHz: 100 Ω ±5 Ω
 TCL: ≥ 50 db - 10 x l_{gf}
 Delay Skew: 18 ns/100 m
 NVP: 67 %

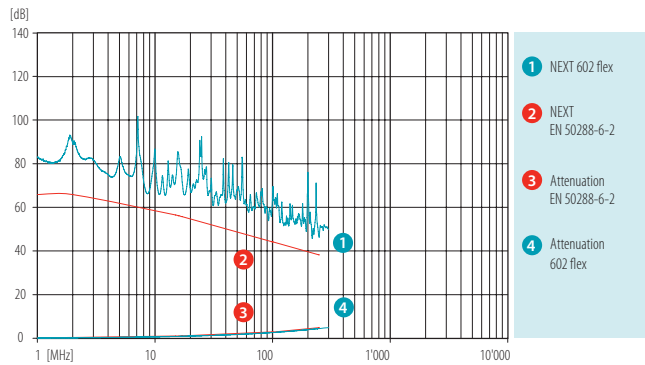

MECHANICAL CHARACTERISTICS

Bending radius: ≥ 20 mm
 Repeated bending: ≥ 1000 cycles
 Tensile strength: ≤ 72 N
 Temperature range: during installation: 0° C to + 50° C
 in operation: -20° C to + 60° C

GENERAL CHARACTERISTICS

Wire colour code: white - blue/blue
 white - orange/orange
 white - green/green
 white - brown/brown (ring marked)
 in accordance with IEC 60189 and IEC 60708

Imprint: DATWYLER «cable type» «additional text» «batch number» «meter marks»

Zero halogen non corrosive gases
 Flame propagation
 Smoke density

Power over Ethernet
 Segregation class
 Cat./Class

IEC 60754-1/-2, EN 50267-2-1/-2-2 (VDE 0482-267-2-1/-2-2) - applies to FRNC/LS0H
 IEC 60332-1-2, EN 60332-1-2 (VDE 0482-332-1-2)
 IEC 61034-1/-2, EN 61034-1/-2 (VDE 0482-1034-1/-2) - applies to FRNC/LS0H
 IEEE 802.3af
 b
 Cat 6 / Class E - limit values as specified by IEC 61156-6 and EN 50288-6-2 guaranteed

TELEPHONE CABLES

Telephone cable, U/UTP, Category 3
DATWYLER 25-pair Cat.3 indoor cable

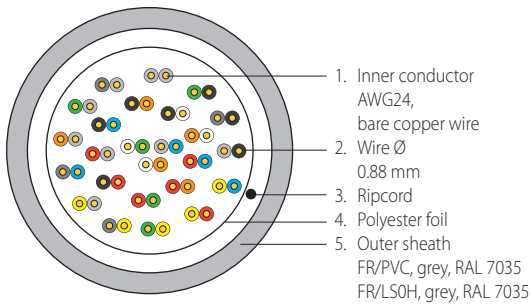

PRODUCT INFORMATION



FEATURES

Electrically and mechanically high-quality 25-pair Cat.3 telephone cable.
 Easy identification of wires thanks to clear longitudinal colour markings and three-layer cable design.
 Exceeds the Cat.3 requirements of TIA/EIA 568B, ISO/IEC 11801, IEC 61156-4, and UL 444.

APPLICATIONS

Cat.3 telephone cable for indoor cabling.
 For the transmission of digital and analogue voice signals.
 Suitable for all applications up to Class C applications.

VERSIONS

Article No.	Dimensions n x n x mm	Sheath	Ø Sheath mm	Weight kg/km	Cu weight kg/km	PU
309046	25 x 2 x 0.50	FR/PVC ¹⁾	11.6	50	27	500 m drum
309103	25 x 2 x 0.50	FR/LSOH ²⁾	11.6	50	27	500 m drum

¹⁾ FR/PVC = Flame Retardant / Polyvinyl Chloride

²⁾ FR/LSOH = Flame Retardant / Low Smoke Zero Halogen

Copper

Fibre Optics

Cabinets & Racks

Data Centre

Wireless

Multimedia

General Information

CU Telefonkabel 25P Cat.3 0714/e



Telephone cable, U/UTP, Category 3

DATWYLER 25-pair Cat.3 indoor cable

ELECTRICAL CHARACTERISTICS

CATEGORY	3				
Frequency [MHz]	1	4	8	10	16
Attenuation [dB/100m]	2.6	5.6	8.5	9.7	13.1
NEXT [dB]	41.3	32.3	27.8	26.3	23.3
ACR-N [dB]	38.7	26.7	19.3	16.6	10.2
ACR-F [dB]	39	26.9	20.9	19.0	14.9
Return loss [dB]	12.0	12.0	12.0	12.0	9.9

These performance data are typical measured values.

	Loop resistance a 20° C:	95 Ω/km	
	Impedance at 1.0-16.0 MHz:	100 Ω ±15 Ω	
	Delay Skew:	45 ns / 100 m	
	NVP:	80 %	
MECHANICAL CHARACTERISTICS	Bending radius	during draw-in:	≥ 92.8 mm
		permanently installed:	≥ 46.4 mm
	Crush resistance:		≤ 100 N
	Temperature range	during installation:	0° C to +50° C
		in operation:	-20° C to +60° C
CABLE DESIGN	3P+9P+13P. Pairs are arranged in three layers.		
GENERAL CHARACTERISTICS	Wire colour code	bu/ wh-bu og/wh-og gn/wh-gn bn/wh-bn gy/wh-gy bu/ rd-bu og/ rd-og gn/ rd-gn bn/rd-bn gy/ rd-gy bu/ bk-bu og/ bk-og gn/ bk-gn bn/ bk-bn gy/ bk-gy bu/ ye-bu og/ ye-og gn/ ye-gn bn/ ye-bn gy/ ye-gy bu/ vt-bu og/ vt-og gn/ vt-gn bn/ vt-bn gy/ vt-gy	
	Imprint	DATWYLER «cable type» «additional text» «batch number» «meter marks»	
	 Flame propagation	IEC 60332-1-2, EN 60332-1-2, VDE 0482-332-1-2	
	 EMV	-	
	 Cat.	better than Cat.3	

TELEPHONE CABLES

Telephone cable, U/UTP, Category 3 DATWYLER 50-pair Cat.3 indoor cable

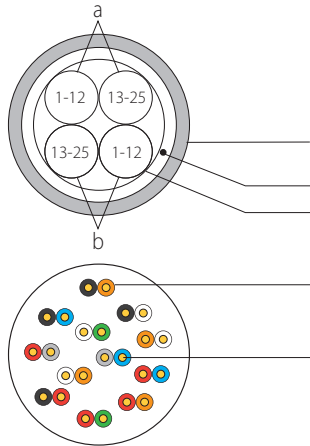

Cable design: 4 wire bundles, 12/13 pairs each

- a. Bundle marked with ID tape wh/bu
- b. Bundle marked with ID tape wh/og
- c. Outer sheath
FR/PVC, grey, RAL 7035
- d. Ripcord
- e. Polyester foil
FR/LSOH, grey, RAL 7035

Wire bundle with 12/13 pairs each

- 1. Inner conductor
AWG24,
bare copper wire
- 2. Wire Ø 0.88 mm

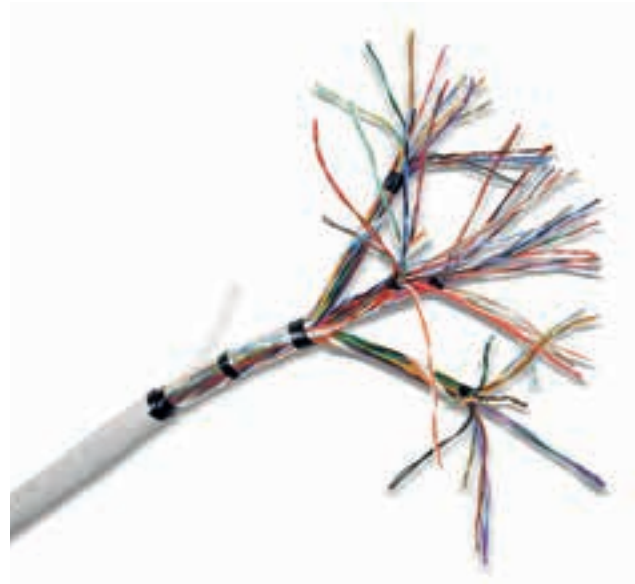

PRODUCT INFORMATION



FEATURES

Electrically and mechanically high-quality 50-pair Cat.3 telephone cable.
Easy identification of wires thanks to clear longitudinal colour markings, wire bundles and three-layer wire bundle design.
Exceeds the Cat.3 requirements of TIA/EIA 568B, ISO/IEC 11801, IEC 61156-4, and UL 444.

APPLICATIONS

Cat.3 telephone cable for indoor cabling.
For the transmission of digital and analogue voice signals.
Suitable for all applications up to Class C applications.

VERSIONS

Article No.	Dimensions n x n x mm	Sheath	Ø Sheath mm	Weight kg/km	Cu weight kg/km	PU
309104	50 x 2 x 0.50	FR/PVC ¹⁾	15	91	55	500 m drum
309047	50 x 2 x 0.50	FR/LSOH ²⁾	15	91	55	500 m drum

¹⁾ FR/PVC = Flame Retardant / Polyvinyl Chloride

²⁾ FR/LSOH = Flame Retardant / Low Smoke Zero Halogen

Telephone cable, U/UTP, Category 3

DATWYLER 50-pair Cat.3 indoor cable

ELECTRICAL CHARACTERISTICS

CATEGORY	3				
Frequency [MHz]	1	4	8	10	16
Attenuation [dB/100m]	2.6	5.6	8.5	9.7	13.1
NEXT [dB]	41.3	32.3	27.8	26.3	23.3
ACR-N [dB]	38.7	26.7	19.3	16.6	10.2
ACR-F [dB]	39	26.9	20.9	19.0	14.9
Return loss [dB]	12.0	12.0	12.0	12.0	9.9

These performance data are typical measured values.

	Loop resistance a 20° C:	95 Ω/km
	Impedance at 1.0-16.0 MHz:	100 Ω ±15 Ω
	Delay Skew:	45 ns / 100 m
	NVP:	80 %
MECHANICAL CHARACTERISTICS	Bending radius	during draw-in: ≥ 120 mm permanently installed: ≥ 60 mm
	Crush resistance:	≤ 100 N
	Temperature range	during installation: 0° C to +50° C in operation: -20° C to +60° C
CABLE DESIGN		4 bundles with 12/13 pairs each. Bundle a: Pairs 1~12 and 13~25 tied up with white/blue identification tape each. Bundle b: Pairs 13~25 and 1~12 tied up with white/orange identification tape each.
GENERAL CHARACTERISTICS	Wire colour code	bu/ wh-bu og/wh-og gn/wh-gn bn/wh-bn gy/wh-gy bu/ rd-bu og/ rd-og gn/ rd-gn bn/rd-bn gy/ rd-gy bu/ bk-bu og/ bk-og gn/ bk-gn bn/ bk-bn gy/ bk-gy bu/ ye-bu og/ ye-og gn/ ye-gn bn/ ye-bn gy/ ye-gy bu/ vt-bu og/ vt-og gn/ vt-gn bn/ vt-bn gy/ vt-gy
	Imprint	DATWYLER «cable type» «additional text» «batch number» «meter marks»
	 Flame propagation  EMV  Cat.	IEC 60332-1-2, EN 60332-1-2, VDE 0482-332-1-2 - better than Cat.3

TELEPHONE CABLES

Telephone cable, U/UTP, Category 3 DATWYLER 100-pair Cat.3 indoor cable

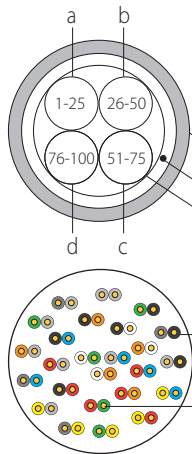

Cable design: 4 wire bundles, 25 pairs each

- a. Bundle marked with ID tape wh/bu
- b. Bundle marked with ID tape wh/og
- c. Bundle marked with ID tape wh/gn
- d. Bundle marked with ID tape wh/bn
- e. Outer sheath
FR/PVC, grey, RAL 7035
- f. Ripcord
- g. Polyester foil
FR/LSOH, grey, RAL 7035

Wire bundle with 25 pairs each

- 1. Inner conductor
AWG24,
bare copper wire
- 2. Wire Ø 0.88 mm



PRODUCT INFORMATION



FEATURES

Electrically and mechanically high-quality 100-pair Cat.3 telephone cable.
Easy identification of wires thanks to clear longitudinal colour markings, wire bundles and three-layer wire bundle design.
Exceeds the Cat.3 requirements of TIA/EIA 568B, ISO/IEC 11801, IEC 61156-4, and UL 444.

APPLICATIONS

Cat.3 telephone cable for indoor cabling.
For the transmission of digital and analogue voice signals.
Suitable for all applications up to Class C applications.

VERSIONS

Article No.	Dimensions n x n x mm	Sheath	Ø Sheath mm	Weight kg/km	Cu weight kg/km	PU
309105	100 x 2 x 0.50	FR/PVC ¹⁾	19.6	170	108	500 m drum
309106	100 x 2 x 0.50	FR/LSOH ²⁾	19.6	170	108	500 m drum

¹⁾ FR/PVC = Flame Retardant / Polyvinyl Chloride

²⁾ FR/LSOH = Flame Retardant / Low Smoke Zero Halogen

Telephone cable, U/UTP, Category 3
DATWYLER 100-pair Cat.3 indoor cable

ELECTRICAL CHARACTERISTICS

CATEGORY	3				
Frequency [MHz]	1	4	8	10	16
Attenuation [dB/100m]	2.6	5.6	8.5	9.7	13.1
NEXT [dB]	41.3	32.3	27.8	26.3	23.3
ACR-N [dB]	38.7	26.7	19.3	16.6	10.2
ACR-F [dB]	39	26.9	20.9	19.0	14.9
Return loss [dB]	12.0	12.0	12.0	12.0	9.9

These performance data are typical measured values.

Loop resistance a 20° C: 95 Ω/km
 Impedance at 1.0-16.0 MHz: 100 Ω ±15 Ω
 Delay Skew: 45 ns / 100 m
 NVP: 80 %

MECHANICAL CHARACTERISTICS

Bending radius during draw-in: ≥ 157 mm
 permanently installed: ≥ 78.5 mm
 Crush resistance: ≤ 100 N
 Temperature range during installation: 0° C to +50° C
 in operation: -20° C to +60° C

CABLE DESIGN

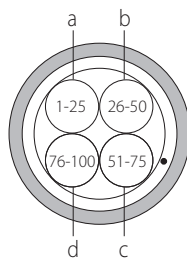

4 bundles with 25 pairs each.
 Bundle a:
 Pairs 1~25 tied up with white/blue identification tape each.
 Bundle b:
 Pairs 26~50 tied up with white/orange identification tape each.
 Bundle c:
 Pairs 51~75 tied up with white/green identification tape each.
 Bundle d:
 Pairs 76~100 tied up with white/brown identification tape.

GENERAL CHARACTERISTICS

Wire colour code bu/ wh-bu og/wh-og gn/wh-gn bn/wh-bn gy/wh-gy
 bu/ rd-bu og/ rd-og gn/ rd-gn bn/rd-bn gy/ rd-gy
 bu/ bk-bu og/ bk-og gn/ bk-gn bn/ bk-bn gy/ bk-gy
 bu/ ye-bu og/ ye-og gn/ ye-gn bn/ ye-bn gy/ ye-gy
 bu/ vt-bu og/ vt-og gn/ vt-gn bn/ vt-bn gy/ vt-gy

Imprint DATWYLER «cable type» «additional text» «batch number» «meter marks»

Flame propagation IEC 60332-1-2, EN 60332-1-2, VDE 0482-332-1-2
 EMV -
 Cat. better than Cat.3

Factory-assembled copper data cables



PRODUCT INFORMATION

CONCEPT

Faster, safer and more cost-effective: the trend towards pre-assembled systems

Ever shorter time frames for new buildings, renovations, modifications and extensions raise the question of how to carry out installations even more quickly, more safely and more cost-effectively.

Installation often has to take place during current operation and needs to be effected without costly on-site work, and as far as possible without any outside contractors. Neither the quality of the solution (maximum availability requirements) nor its performance should be forfeited in the process.

Datwyler's modular trunk solutions provide the perfect answer. Pre-assembled trunk cables are fabricated using high-performance cable products which are supplied in combination with different performance levels, modules and connectors. The products are delivered in the lengths requested by the customer and have already been tested and certified in accordance with the latest standards.

This provides installers and operators, particularly in data centers, with products which make it possible to install even extensive copper-based systems to the highest quality in a very short time.

DESCRIPTION

Tailor-made pre-terminated copper trunk cable assemblies

- in the requested lengths
- with customized imprints on the single cables
- with the requested connectors
- 100% pre-tested, with measurement reports

APPLICABLE STANDARDS

Depending on the chosen type and Category of cable and connector the Class is based on the following standards:

- ISO/IEC 11801:2002 / Amd.2:2010
- EN 50173-1:2011
- TIA/EIA 568-B.2-10: 2008



PRODUCT INFORMATION

MODULES AND PLUGS FOR TRUNKS

type	application	construction	compatible with cable	
Modules Category 7_A / Class 7_A				
	Module PS-GG45 7 _A 4P (Cat.7 _A)	min. 10Gbase-T	shielded	flex / solid
	Module PS TERA 4P Cat. 7 _A	min. 10GBase-T	shielded	solid
Modules Category 6_A / Class E_A				
	RJ45 module KS-T Plus 1/8 Cat. 6 _A (IEC)	up to 10GBase-T	shielded	flex / solid
	RJ45 module MS-K Plus 1/8 Cat. 6 _A (IEC)	up to 10GBase-T	shielded	flex / solid
	RJ45 module MS-C _{6A} 1/8 Cat. 6 _A (IEC)	up to 10GBase-T	shielded	flex / solid
Plugs Category 6/6_A / Class E_A				
	RJ45 plug 4P Cat. 6 _A	up to 10GBase-T	shielded	flex / solid
	RJ45 plug 4P Cat. 6	up to 10GBase-T	shielded	flex / solid

CABLE TYPES FOR TRUNKS

type	maximum Class	application	Ø [mm]	maximum length [m]	
Solid BOL (Breakout light) cables					
3-fold	CU 7002 3x4P	F	min. 10GBase-T	16.1	85
4-fold	CU 7002 4x4P	F	min. 10GBase-T	18.0	85
6-fold	CU 7002 6x4P	F	min. 10GBase-T	21.2	85
Flex BOL (Breakout light) cables					
6-fold	CU 7702 6x4P flex	F	min. 10GBase-T	17.6	60
12-fold	CU 7702 12x4P flex	F	min. 10GBase-T	22.2	60
Flex tube cables					
3-fold	CU 7702 3x4P flex	F	min. 10GBase-T	12	60
6-fold	CU 7702 6x4P flex	F	min. 10GBase-T	20	60
8-fold	CU 7702 8x4P flex	F	min. 10GBase-T	22	60
12-fold	CU 7702 12x4P flex	F	min. 10GBase-T	27	60
16-fold	CU 7702 16x4P flex	F	min. 10GBase-T	32	60
Single cables					
	CU 7702 4P flex	F	min. 10GBase-T	5.8	60
2-fold	CU 7702 4P flex	F	min. 10GBase-T	5.8 x 11.6	60
	CU 7120 4P	F _A	min. 10GBase-T	7.5	90
2-fold	CU 7120 2x4P F8	F _A	min. 10GBase-T	7.5 x 15.8	90

Dimensions & length definition

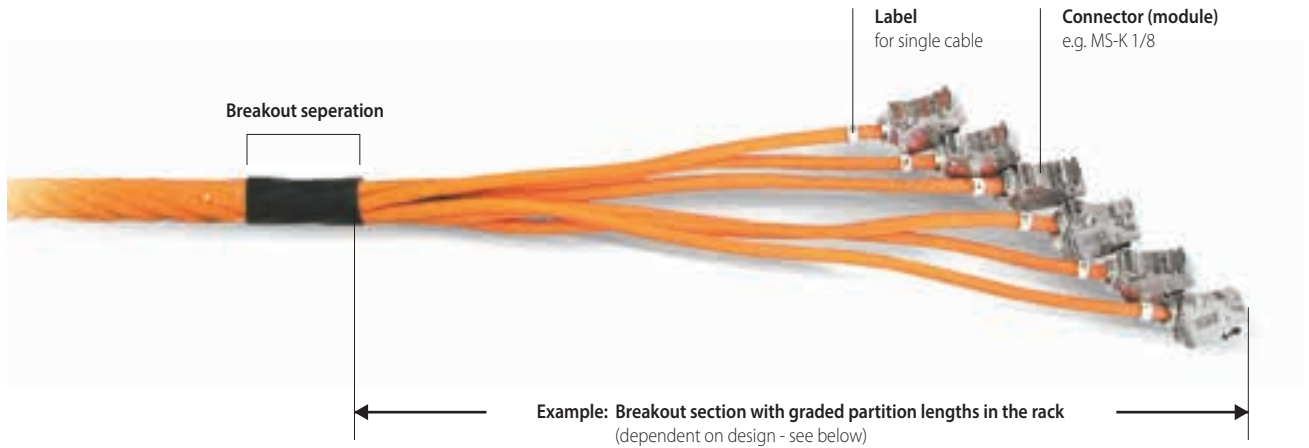

PRODUCT INFORMATION

DIMENSIONS

Flex BOL cable 12-fold
CU 7702 12x4P flex

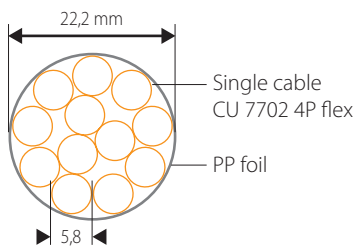

Solid BOL cable 6-fold
CU 7002 6x4P

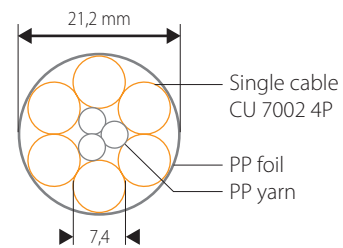

LENGTH DEFINITION

The following criteria are decisive for all pre-assembled copper trunks from Datwyler:

Length_{horizontal}

Horizontal distance between the racks (cable fed from ceiling/from below).

We recommend the cables to be laid in trays above the racks to ensure that there will be no disruption to cooling air flow in the false floor. However, the cables can also be directed through the raised floor when it is amply dimensioned.

A1

Vertical distance up to the fixing point inside rack A

B1

Vertical distance up to the fixing point inside rack B

A2 (as per design)

Breakout section in rack A (pre-assembled with connectors)

B2 (as per design)

Breakout section in rack B (pre-assembled with connectors)

R

Admissible bending radius for the copper trunk in case of insertion into the rack from ceiling or from below.

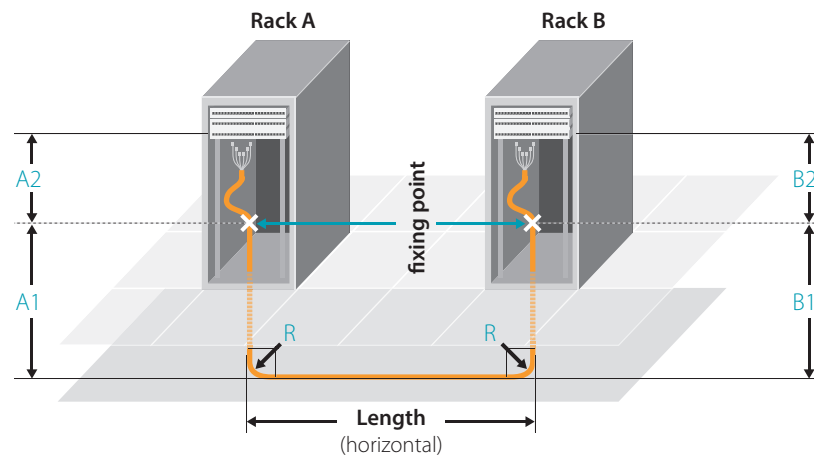

$$\text{Total length for PO} = \text{Length}_{\text{horizontal}} + A1 + B1$$

Checklist: Project planning with copper trunks

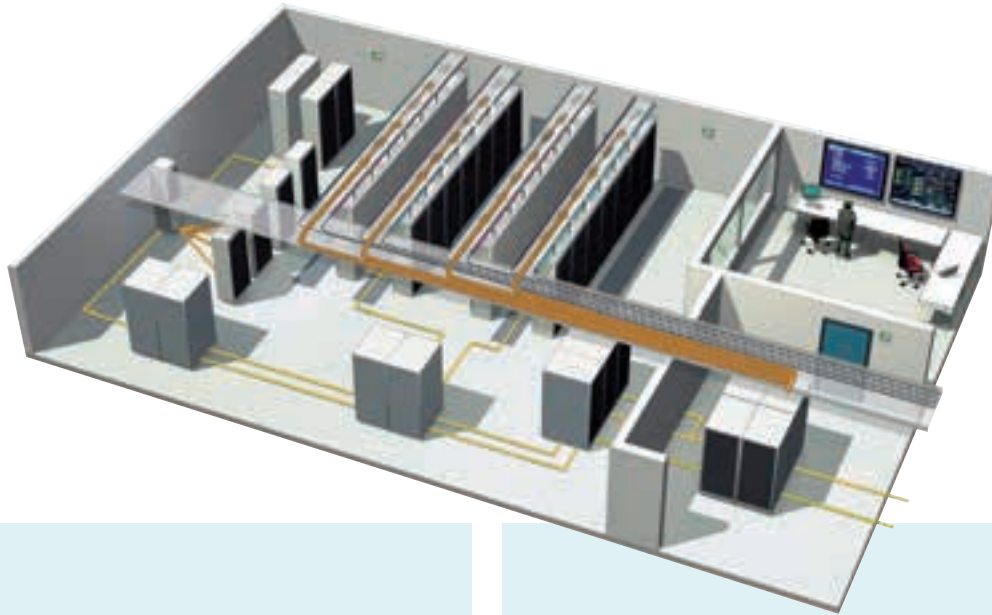

Project planning with copper trunks



DO YOU NEED THE COPPER TRUNKS FOR TODAY OR FUTURE NEEDS?

1GBase-T, 10GBase-T, ...



PLEASE CHOOSE THE RIGHT COPPER CABLE TYPE!

Select the cable type - taking into account the requested number of single cables and their Category.
Flex cables are particularly flexible in terms of packing density but have higher attenuation - their maximum link lengths are a little bit shorter!



PLEASE SELECT THE MODULES OR PLUGS FOR THE PLANNED APPLICATION!

Category 5e, 6, 6_A, 7 or 7_A?
For Class D, E, E_A, F or F_A?



PLEASE CHOOSE THE SUITABLE PATCH PANEL!

- KS
- MS
- MPS
- ...



WHAT WILL BE THE LENGTH OF THE REQUESTED COPPER TRUNKS?

Where do you want to install them?
In cable trays above the racks or in the false floor?
Please consider the diameter, the weight and the admissible bending radius of the trunks!



HOW DO YOU WANT TO ROUTE THE CABLES INSIDE THE DISTRIBUTION RACK TO THE PATCH PANELS?

- side-fed from right?
- side-fed from left?
- centred from behind?
- or ...?



THE SINGLE CABLES CAN BE GRADED IN LENGTH - DEPENDING ON HOW THE TRUNK CABLES IS FIXED INSIDE THE RACK.

The single cables may all have the same length - with enough reserve up to the farthest connecting point.
Excess cable lengths can be laid in a tray behind a 19"/1U cable management panel.



CUSTOMER-SPECIFIC IMPRINT / LABELLING?

Available on request for all copper trunks.



PLEASE CONSIDER SOME EXTRA TIME FOR THE PRE-ASSEMBLY IN YOUR TIMETABLE!

YOU NEED CONSULTING SERVICE?
PLEASE DO NOT HESITATE TO CALL US.
WE WILL BE HAPPY TO HELP YOU!

You will find the Datwyler phone numbers on the back page of the catalogue.
For all current information please see our website

www.cabling.datwyler.com

COPPER PATCH CORDS

High-end network isolator EN-60KDS

Surge protection and galvanic isolation
in one compact Keystone module

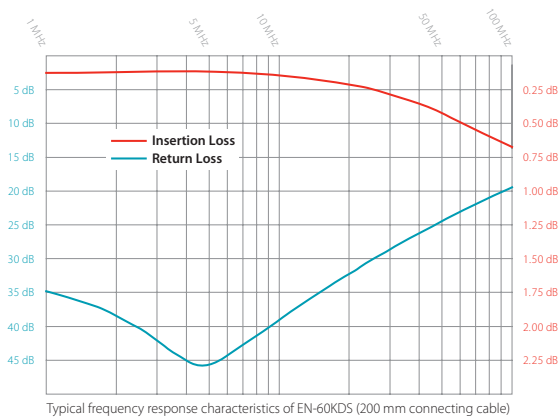

PRODUCT INFORMATION

DESCRIPTION

Compact 1-gigabit network isolator in Keystone construction suitable for device installation or permanent installation.

Can be used in any Keystone-compatible wall outlet panel.

When retrofitting existing installations its rear connecting cable acts as a simple extension.

Meets the performance requirements of TIA 568 Cat. 5e and ISO 11801 Class D in the Permanent Link and is thus designed for transmissions of up to 1 gigabit per second.

APPLICATION

In medical technology, recording studios, measuring and monitoring technology and in the potential-free connection of remote computer systems.

Galvanic isolation of any device connected to a copper-based Ethernet network (wires and screen).

Suppresses potential equalisation currents and protects medical and non-medical equipment and systems from the consequences of dangerous network voltage surges which can be caused by switching operations, moisture, electrostatic discharge, differences in potential or lightning strike.

Attenuates low-frequency signal components so well that it effectively prevents ripple pickup in connected devices.

STANDARDS

IEC 60601- 1:1988 A1:1991 and A2: 1995 (2nd Edition); IEC 60601-1-1:2000; IEC 60601- 1: 2005 (3rd Edition); IEC 60601-1-2:2007; UL 60601; IEC 61000-4-2 (ESD; 15kV Air / 8kV Contact); IEC 61000-4-4 (EFT; 40A, 5/50ns) and IEC 61000-4-5 (Lightning; 12A 8/20 µs)

TECHNICAL SPECIFICATIONS

Length of connecting cable: 20 cm = standard on stock, other lengths on request (from 3 cm up to 10 m)

Electric strength: 6000 VAC at 50 Hz (1 min.), 8500 VDC

Insertion Loss: < 1dB (1 MHz < f < 100 MHz)

Supported network protocols: IEEE802.3 10BaseT (Cl.14), 100BaseTx (Cl.25), 1000BaseT (Cl.40)

Kenzeichnungen: CE, UL (E249126), RoHS compliant, lead-free

Operating conditions: Temperature: 10° bis 45° C / Air humidity: 10% up to 90% (non-condensing) / Barometric pressure: 860 hPa up to 1060 hPa

Maximum applied voltage (permanent): 400 VAC at 50/60 Hz

Dimensions (housing w/o cable): H x W x L = 23.5 x 17.3 x 39.9 mm

Article No.	Description	PU
417906 + length of cable	High-end network isolator EN-60KDS, length = ? cm	1 pc.

Datwyler is a distribution partner of EMO Systems GmbH

Copper

Fibre Optics

Cabinets & Racks

Data Centre

Wireless

Multimedia

General Information

High-End Netzwerkisolator EN-60KDS 0714/e

PS-GG45 patch cords

Measurement / Patch cord PS-GG45 7_A 1000 MHz 4P, shielded
 Adapter patch cords PS-GG45 7_A / RJ45 4P, shielded



Measurement/patch cord 1000 MHz 4P
 PS-GG45™ 7_A / PS-GG45 7_A



Adapter patch cord 4P
 PS-GG45 7_A / RJ45

PRODUCT INFORMATION

APPLICATION

Measurement / Patch cord PS-GG45 7_A 1000 MHz 4P, shielded

Patch cords with PS-GG45 7_A plugs allow for Class F_A compliant cabling systems (up to 1000 MHz) and for Class F installations (up to 600 MHz). The PS-GG45 7_A plug uses only 4 x 2 contacts in the top and bottom corners of the PS-GG45 7_A module, whereby best NEXT und RL values can be achieved. The unused contacts will be connected through a switch to ground. Measurement cords with PS-GG45 7_A plugs are primarily needed for acceptance testings.

Adapter patch cords PS-GG45 7_A / RJ45 4P, shielded

As PS-GG45 7_A plugs are not compatible with RJ45 jacks, the RJ45 jacks in active devices can be connected to the high-performance cabling system with adapter patch cords only. These flex cables are fitted with a PS-GG45 7_A plug on one side and a RJ45 plug on the other side.

Future viability

GG45 cabling systems that use standard patch cords (RJ45/RJ45) provide enough electrical reserve capacities for 10-gigabit Ethernet applications (10GBase-T).

When deploying adapter patch cords with one RJ45 and one PS-GG45 plug you can achieve more than 1000 times better reserve capacities in the Channel.

These reserve capacities are large enough also for the transmission of future applications in Class F_A cabling systems up to 1000 MHz.

APPLICABLE STANDARDS

IEC 60603-7- (RJ45)
 IEC 60076-3-110 (GG45, not backward compatible with RJ45)
 ISO/IEC 11801:2002/Amd.1:2008 and Amd.2:2010 (Class F_A)
 EN 50173-1:2011

Article No.	Length	Description	Plug 1 / plug 2	Cable	Colour	Wiring
400120	2 m	Measurement/Patch cord 1000 MHz 4P	GG45 7 _A / GG45 7 _A	FRNC/LS0H ¹⁾	orange	1:1
400121*	1 m	Adapter patch cord 4P	GG45 7 _A / RJ45	FRNC/LS0H	orange	1:1
400122*	2 m	Adapter patch cord 4P	GG45 7 _A / RJ45	FRNC/LS0H	orange	1:1
400123*	3 m	Adapter patch cord 4P	GG45 7 _A / RJ45	FRNC/LS0H	orange	1:1
400125*	5 m	Adapter patch cord 4P	GG45 7 _A / RJ45	FRNC/LS0H	orange	1:1

* Minimum order quantity: 25 pcs.

¹⁾ FRNC/LS0H = Flame Retardant Non Corrosive / Low Smoke Zero Halogen

GG45™ is a registered trade name of NEXANS

COPPER PATCH CORDS

PS-TERA / RJ45 patch cords

Measurement / Patch cord PS-TERA 4P, shielded
Adapter patch cords PS-TERA / RJ45, shielded



PRODUCT INFORMATION

APPLICATION

Measurement/Patch cord PS-TERA™ 4P with flexible cable CU 7150 4P flex, shielded

Patch cords with PS-TERA 4P plugs allow for Class F_A compliant cabling systems (up to 1000 MHz) and for Class F installations (up to 600 MHz).

Measurement cords with PS-TERA 4P plugs are primarily needed for acceptance testings.

Adapter patch cords PS-TERA / RJ45 with flexible cables CU 7702 4P flex, shielded

For multimedia cabling systems with tried and tested copper components and innovative connection technology for Class F_A in accordance with EN 50173 and ISO/IEC 11801.

PS-TERA connectors guarantee highest flexibility: Each port of one 4P module can be used for a separate patch. This allows for simultaneous transmission of TV, video, data and voice in one and the same data cable (1 pair for each application).

DESCRIPTION

The PS-TERA adapter patch cords are available in many types for adaption to the RJ45 standard. They are fitted with a PS-TERA plug for 4, 2 or 1 pair on one side and a RJ45 plug or RJ11 plug (telephony) on the other side.

APPLICABLE STANDARD

ISO/IEC 11801:2002/Amd.1:2008 and Amd.2:2010
EN 50173-1:2011

GENERAL CHARACTERISTICS

Zero halogen	IEC 60754-1/-2, EN 50267-2-1/-2-2
non corrosive gases	(VDE 0482-267-2-1/-2-2) - applies to FRNC/LSOH
Flame propagation	IEC 60332-1-2, EN 60332-1-2 (VDE 0482-332-1-2)
Smoke density	IEC 61034-1/-2, EN 61034-1/-2
	(VDE 0482-1034-1/-2) - applies to FRNC/LSOH
Power over Ethernet	IEEE 802.3at
EMC	shielded
Category/Class	Cat. 7 _A / Class F _A with PS-TERA 4P plugs on both ends
	Cat. 6 _A / Class E _A with one PS-TERA 4P and one RJ45 4P plug
	Cat. 5e / Class D with one PS-TERA 2P and one RJ45 2P plug
	Cat. 3 / telephony with one PS-TERA 1P and one RJ11 1P plug

TERA™ is a registered Trademark of SIEMON

PS-TERA / RJ45 patch cordsMeasurement / Patch cord PS-TERA 4P, shielded
Adapter patch cords PS-TERA / RJ45, shielded**PRODUCT INFORMATION**

Article No.	Length	Boot colour		Description	Plug 1 / plug 2	Cable	Cable colour	Wiring
		PS-TERA	RJ45					
654010	2,0 m			Mess-/Patchkabel	PS-TERA 4P / PS-TERA 4P	FRNC/LSOH ¹⁾	grau	1:1
654058	1 m	black	black	Adapter patch cord	PS-TERA 4P / RJ45	FRNC/LSOH	grey	1:1
654060	2 m	black	black	Adapter patch cord	PS-TERA PS 4P / RJ45	FRNC/LSOH	grey	1:1
654062	3 m	black	black	Adapter patch cord	PS-TERA PS 4P / RJ45	FRNC/LSOH	grey	1:1
654066	5 m	black	black	Adapter patch cord	PS-TERA PS 4P / RJ45	FRNC/LSOH	grey	1:1
654158	1 m	yellow	yellow	Adapter patch cord	PS-TERA PS 2P / RJ45	FRNC/LSOH	grey	100BT (A)
654160	2 m	yellow	yellow	Adapter patch cord	PS-TERA PS 2P / RJ45	FRNC/LSOH	grey	100BT (A)
654162	3 m	yellow	yellow	Adapter patch cord	PS-TERA PS 2P / RJ45	FRNC/LSOH	grey	100BT (A)
654166	5 m	yellow	yellow	Adapter patch cord	PS-TERA PS 2P / RJ45	FRNC/LSOH	grey	100BT (A)
654258	1 m	blue	grey	Adapter patch cord	PS-TERA PS 2P / RJ45	FRNC/LSOH	grey	TR
654260	2 m	blue	grey	Adapter patch cord	PS-TERA PS 2P / RJ45	FRNC/LSOH	grey	TR
654262	3 m	blue	grey	Adapter patch cord	PS-TERA PS 2P / RJ45	FRNC/LSOH	grey	TR
654266	5 m	blue	grey	Adapter patch cord	PS-TERA PS 2P / RJ45	FRNC/LSOH	grey	TR
654208	1 m	red	red	Adapter patch cord	PS-TERA PS 2P / RJ45	FRNC/LSOH	grey	100BT (B)uplink
654210	2 m	red	red	Adapter patch cord	PS-TERA PS 2P / RJ45	FRNC/LSOH	grey	100BT (B)uplink
654212	3 m	red	red	Adapter patch cord	PS-TERA PS 2P / RJ45	FRNC/LSOH	grey	100BT (B)uplink
654216	5 m	red	red	Adapter patch cord	PS-TERA PS 2P / RJ45	FRNC/LSOH	grey	100BT (B)uplink

Note: customised patch cords (e.g. length, type) on request.

¹⁾ FRNC/LSOH = Flame Retardant Non Corrosive / Low Smoke Zero Halogen

COPPER PATCH CORDS

RJ45 patch cords Cat. 6_A (IEC) 500 MHz
shielded, wiring 1:1



PRODUCT INFORMATION

DESCRIPTION

Shielded patch cords and connection cables with shielded RJ45 plug on both ends, fitted with an overmoulding and an anti-slag boot in the same colour as the cable sheath and with latch protection. The cable CU 7702 flex 4P (Cat. 7) offers excellent NEXT and impedance values due to the individually foil screened pairs (PiMF). Due to the overall copper braid, the patch cables have an excellent screen performance and are highly flexible. They are optimized for the transmission of CATV signals up to 862 MHz. The patch cords meet all the requirements of Category 6_A (IEC) and the limit values stipulated for Class E_A cabling links (Channels) for 10GBase-T applications.

Standard assortment: from 0.5 m up to 20 m.
Customised adjustments (anti-slag boot, termination, label) are available at short notice.

APPLICABLE STANDARDS

IEC 61935-2:2010 (Cat. 6_A)
ISO/IEC 11801:2001 / Amd.1:2008 and Amd.2:2010 (Class E_A)
EN 50173-1:2011

GENERAL CHARACTERISTICS

- Zero halogen
 - non corrosive gases
 - Flame propagation
 - Smoke density
 - EMC
 - Category/Class
- IEC 60754-1/-2, EN 50267-2-1/-2-2
(VDE 0482-267-2-1/-2-2) - applies to FRNC/LSOH¹⁾
IEC 60332-1-2, EN 60332-1-2 (VDE 0482-332-1-2)
IEC 61034-1/-2, EN 61034-1/-2,
(VDE 0482-1034-1/-2) - applies to FRNC/LSOH shielded
Cat 6_A, Class E_A for 10GBase-T and 1GBase-T
CATV 862 MHz

Length	Article No. RJ45 patch cord Cat. 6 _A shielded, wiring 1:1 (with CU 7702 4P flex FRNC/LSOH ¹⁾ Cat. 7)					
	grey	green	yellow	red	blue	orange
0.5 m	653503	653553	653603	653653	653703	(653753)*
1.0 m	653508	653558	653608	653658	653708	653758
1.5 m	653509	653559	653609	653659	653709	(653759)*
2.0 m	653510	653560	653610	653660	653710	653760
2.5 m	653511	653561	653611	653661	653711	(653761)*
3.0m	653512	653562	653612	653662	653712	653762
4.0 m	653514	653564	653614	653664	653714	(653764)*
5.0 m	653516	653566	653616	653666	653716	653766
6.0 m	653518	653568	653618	653668	653718	(653768)*
7.0 m	653520	653570	653620	653670	653720	653770
8.0 m	653522	653572	653622	653672	653722	(653772)*
9.0 m	653524	653574	653624	653674	653724	(653774)*
10.0 m	653526	653576	653626	653676	653726	(653776)*
12.5 m	653527	653577	653627	653677	653727	(653777)*
15.0 m	653528	653578	653628	653678	653728	(653778)*
20.0 m	653530	653580	653630	653680	653730	(653780)*

Note: Products marked with (*) and lengths up to 100 m are not on stock but can be delivered at short notice. Please do not hesitate to contact us.

¹⁾ FRNC/LSOH = Flame Retardant Non Corrosive / Low Smoke Zero Halogen



PRODUCT INFORMATION

DESCRIPTION

The Datwyler patch cords and connection cables are fitted with a shielded RJ45 plug and a moulded anti-sag boot on both ends. The cable CU 5502 flex 4P offers an excellent screen performance due to its overall copper braid and is highly flexible.

Standard assortment: from 0.5 m until 20 m.
Customised adjustments (anti-sag boot, termination, label) are available at short notice.

APPLICABLE STANDARDS

ISO/IEC 11801:2002 (Class D, Channel)
EN 50173: 2011

GENERAL CHARACTERISTICS

Zero halogen	IEC 60754-1/-2, EN 50267-2-1/-2-2
non corrosive gases	(VDE 0482-267-2-1/-2-2) - applies to FRNC/LS0H ²⁾
Flame propagation	IEC 60332-1-2, EN 60332-1-2 (VDE 0482-332-1-2)
Smoke density	IEC 61034-1/-2, EN 61034-1/-2
Power over Ethernet	(VDE 0482-1034-1/-2) - applies to FRNC/LS0H
EMC	IEEE 802.3at
Category/Class	shielded
	Cat. 5/5e / Class D for 100Base-T and 1GBase-T

Length	Article No. FR/PVC ¹⁾	FR/PVC	FR/PVC	FR/PVC	FR/PVC	FRNC/LS0H ²⁾
	grey	green	yellow	red	blue	orange
0.5 m	652003	652053	652103	652153	652203	(652753)*
1.0 m	652008	652058	652108	652158	652208	652758
1.5 m	652009	652059	652109	652159	652209	(652759)*
2.0 m	652010	652060	652110	652160	652210	652760
2.5 m	652011	652061	652111	652161	652211	(652761)*
3.0 m	652012	652062	652112	652162	652212	652762
4.0 m	652014	652064	652114	652164	652214	(652764)*
5.0 m	652016	652066	652116	652166	652216	652766
6.0 m	652018	652068	652118	652168	652218	(652768)*
7.0 m	652020	652070	652120	652170	652220	(652770)*
8.0 m	652022	652072	652122	652172	652222	652772
9.0 m	652024	652074	652124	652174	652224	(652774)*
10.0 m	652026	652076	652126	652176	652226	(652776)*
12.5 m	652027	652077	652127	652177	652227	(652777)*
15.0 m	652028	652078	652128	652178	652228	(652778)*
20.0 m	652030	652080	652130	652180	652230	(652780)*

Note: Products marked with (*) and lengths up to 100 m are not on stock but can be delivered at short notice. Please do not hesitate to contact us.

¹⁾ FR/PVC = Flame Retardant / Polyvinyl chloride

²⁾ FRNC/LS0H = Flame Retardant Non Corrosive / Low Smoke Zero Halogen

COPPER PATCH CORDS

RJ45 measurement cable Cat. 6_A (IEC) 500 MHz shielded, set with 2 pcs.

with serial numbers for documentation



PRODUCT INFORMATION

APPLICATION

For Channel link acceptance testings of Class D, E and E_A cabling.
When using test devices with dual measurement capability this cable is also suitable for Permanent Link measurements.

DESCRIPTION

RJ45 measurement cable Cat. 6_A (IEC) up to 500 MHz, shielded, with serial numbers for documentation (set with 2 pieces).

Pack:	in resealable plastic bag
Cable sheath:	orange, halogen-free
Anti-snag boot:	moulded, grey, length: 2.0 m
Serial number imprint:	date (week/year) + batch number (for identification and traceability of the cables)
Measurement report:	included as colour printing, cable batch no. on the test report (report for each cable with parameters: NEXT, Insertion Loss, RL)
Identification:	side A and B with laminated label

APPLICABLE STANDARDS

IEC 61935-2:2010 (Cat. 6_A)
ISO/IEC 11801:2001/Amd.2:2010 (Class E_A)
EN 50173-1:2011

Article No.	Description	PU
1411063	RJ45 measurement cable Cat. 6 _A (IEC), shielded, L = 2,0 m, orange cable sheath, anti-snag boot in grey/grey (2 pcs.)	1 set



PRODUCT INFORMATION

APPLICATION

Datwyler's patch cords and connection cables IP67 Cat. 6 are especially suitable for the harsh, industrial environment. The IP67 RJ45 plug is compatible with the Datwyler Modular Solution IP67 components.

DESCRIPTION

The cable type CU 7702 4P flex FRNC/LS0H Cat. 7 provides outstanding electrical and mechanical properties. The shielded pairs (PiMF) and an additional overall copper braid ensure outstanding NEXT and impedance values.

The cable type CU 7702 4P flex Industrial PUR (Cat. 7) meets additional requirements of the industrial environment like oil resistance and robustness.

The standard version is fitted with an IP67 RJ45 plug on one side and a RJ45 plug with a moulded anti-snag boot on the other side.

In addition to the standard version this patch cable is available in other lengths and with other combinations of plugs (on request).

GENERAL PROPERTIES

Zero halogen non corrosive gases	IEC 60754-1/-2, EN 50267-2-1/-2-2 (VDE 0482-267-2-1/-2-2) - applies to FRNC/LS0H
Flame propagation	IEC 60332-1-2, EN 60332-1-2 (VDE 0482-332-1-2)
Smoke density	IEC 61034-1/-2, EN 61034-1/-2 (VDE 0482-1034-1/-2) - applies to FRNC/LS0H
Oil resistant	EN 60811-2-1 - applies to PUR
Power over Ethernet	IEEE 802.3at
EMC	shielded
Category/Class	Cat. 6 / Class E

Patch cord:	plug A	IP67 RJ45, grey
	plug B	RJ45, anti-snag boot grey or orange

The IP67 plugs are compatible with Datwyler's IP67 RJ45 connection components
Article No. 185719, 185725, 185726, 417530

Length	Article No.	CU 7702 4P flex Industrial PUR ¹⁾	CU 7702 4P flex Industrial FRNC/LS0H ²⁾
		plug B anti-snag boot grey	plug B anti-snag boot grey
1.0 m		664508	664008
2.0 m		664510	664010
3.0 m		664512	664012
5.0 m		664516	664016
7.0 m		664520	664020
10.0 m		664526	664026

¹⁾ PUR = Polyurethane ²⁾ FRNC/LS0H = Flame Retardant Non Corrosive / Low Smoke Zero Halogen

COPPER PATCH CORDS

RJ45 patch cords Cat. 6 UTP 250 MHz
unshielded, wiring 1:1

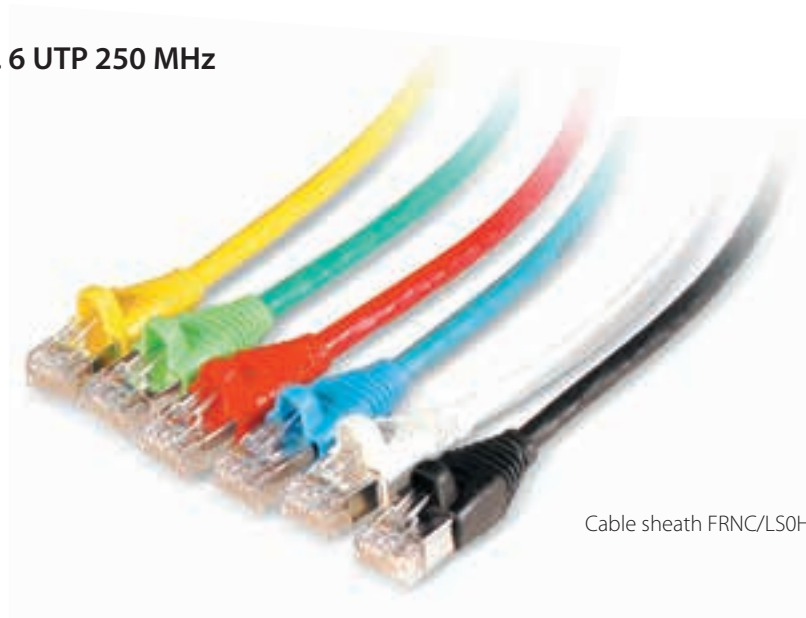

Cable sheath FRNC/LSOH¹⁾

PRODUCT INFORMATION

DESCRIPTION

Datwyler's unshielded Cat. 6 RJ45 patch cords and connection cables (up to 250 MHz) are fitted with a shielded RJ45 plug and a coloured moulded anti-snap boot on both ends. Plugs and anti-snap boots form one unit. The shielded RJ45 plugs provide for better performance. The CU 602 4P flex cable is suitable for transmission rates up to 250 MHz.

GENERAL CHARACTERISTICS

- Zero halogen
non corrosive gases
 - Flame propagation
 - Smoke density
 - Power over Ethernet
 - Category/Class
- IEC 60754-1/-2, EN 50267-2-1/-2-2
(VDE 0482-267-2-1/-2-2) - applies to FRNC/LSOH¹⁾
IEC 60332-1-2, EN 60332-1-2 (VDE 0482-332-1-2)
IEC 61034-1/-2, EN 61034-1/-2
(VDE 0482-1034-1/-2) - applies to FRNC/LSOH
IEEE 802.3af
better than Cat. 6 / Class E

Length	Article No. RJ45 patch cord Cat. 6 unshielded, wiring 1:1 (with CU 602 4P flex, FRNC/LSOH ¹⁾ Cat. 6)							
	grey	green	yellow	red	blue	white	black	
0.5 m	651553	651853	651703	651803	651753	651653	651603	
1.0 m	651558	651858	651708	651808	651758	651658	651608	
1.5 m	651559	651859	651709	651809	651759	651659	651609	
2.0 m	651560	651860	651710	651810	651760	651660	651610	
2.5 m	651561	651861	651711	651811	651761	651661	651611	
3.0 m	651562	651862	651712	651812	651762	651662	651612	
4.0 m	651564	651864	651714	651814	651764	651664	651614	
5.0 m	651566	651868	651716	651816	651766	651666	651616	
6.0 m	651568	651870	651718	651818	651768	651668	651618	
7.0 m	651570	651872	651720	651820	651770	651670	651620	
7.5 m	651571	651874	651721	651821	651771	651671	651621	
8.0 m	651572	651876	651722	651822	651772	651672	651622	
10.0 m	651576	651877	651726	651826	651776	651676	651626	
15.0 m	651578	651878	651728	651828	651778	651678	651628	
20.0 m	651580	651880	651730	651830	651780	651680	651630	

¹⁾ FRNC/LSOH = Flame Retardant Non Corrosive / Low Smoke Zero Halogen

RJ45 patch cords Cat. 6 UTP 250 MHz unshielded, wiring 1:1



Cable sheath FR/PVC¹⁾
or FRNC/LSOH²⁾

PRODUCT INFORMATION

APPLICATION	Applicable for all applications up to Class E (250 MHz), for example Gigabit Ethernet 1000Base-T, Fast Ethernet 100Base-T, ISDN, and PoE according to IEEE 802.3af.
DESCRIPTION	RJ45 patch cord, Cat. 6 (up to 250 MHz), unshielded, with a RJ45 plug (Cat. 6) and a moulded anti-snag boot on both ends. Unshielded flexible cable U/UTP, 250 MHz, 4P, AWG 24. Cable sheath made of FR/PVC, also available as FRNC/LSOH. RJ45 plugs (8/8) Cat. 6 in accordance with IEC 60603-7-4.
PROPERTIES	Flame retardant in accordance with IEC 60332-1, RoHS compliant.
APPLICABLE STANDARDS	IEC 61935-2, TIA/EIA 568-B.2-1 Cat.6, Commercial Building Telecommunications Cabling Standard, part 2: Balanced Twisted-Pair Cabling Components (as of June 2002).
PACKING UNIT	One patch cord, bundled as a ring in a plastic bag.

Length ³⁾	Article No. RJ45 patch cord U/UTP Cat. 6, wiring 1:1, with grey cable sheath FR/PVC ¹⁾ or FRNC/LSOH ²⁾	
	FR/PVC	FRNC/LSOH
1.0 m	309021	309321
1.5 m	309022	309322
2.0 m	309023	309323
3.0 m	309025	309325
4.0 m	309026	309326
5.0 m	309027	309327
7.0 m	309029	309329
10.0 m	309031	309331

¹⁾ FR/PVC = Flame Retardant / Polyvinyl chloride

²⁾ FRNC/LSOH = Flame Retardant Non Corrosive / Low Smoke Zero Halogen

³⁾ other lengths on request, minimum order quantity = 100 pieces

COPPER PATCH CORDS

RJ45 patch cords Cat.5e UTP 100 MHz unshielded, wiring 1:1



PRODUCT INFORMATION

APPLICATION	Applicable for all applications up to Class D (100 MHz), for example Gigabit Ethernet 1000Base-T, Fast Ethernet 100Base-T, ISDN, and PoE according to IEEE 802.3af.
DESCRIPTION	RJ45 patch cord Cat.5e (up to 100 MHz), unshielded, with a RJ45 plug (Cat. 6) and a moulded anti-snag boot on both ends. Unshielded flexible cable U/UTP Cat. 5e, 100 MHz, 4P, AWG 24. Cable sheath made of FR/PVC, also available as FRNC/LSOH. RJ45 plugs (8/8) Cat. 6 in accordance with IEC 60603-7-2.
PROPERTIES	Flame retardant in accordance with IEC 60332-1, RoHS compliant.
APPLICABLE STANDARDS	IEC 61935-2, TIA/EIA 568-B.2-1 Cat. 5e, Commercial Building Telecommunications Cabling Standard, part 2: Balanced Twisted-Pair Cabling Components (as of June 2002).
PACKING UNIT	One patch cord, bundled as a ring in a plastic bag.

Length ³⁾	Article no. RJ45 patch cord U/UTP Cat. 5e, wiring 1:1, with grey cable sheath FR/PVC ¹⁾ or FRNC/LSOH ²⁾	
	grey FR/PVC	grey FRNC/LSOH
1.0 m	309001	309301
1.5 m	309002	309302
2.0 m	309003	309303
3.0 m	309005	309305
4.0 m	309006	309306
5.0 m	309007	309307
7.0 m	309009	309309
10.0 m	309011	309310

¹⁾ FR/PVC = Flame Retardant / Polyvinyl chloride

²⁾ FRNC/LSOH = Flame Retardant Non Corrosive / Low Smoke Zero Halogen

³⁾ other lengths on request, minimum order quantity = 100 pieces

Cable clips 2D
for labelling of patch cords



Fig. 1: Cable clip 2D to be attached to existent patch cord



Fig. 2: Patch cable with pre-assembled Cable clip 2D (with bar code)



Fig. 3: Cable clip 2D with customized text

PRODUCT INFORMATION

DESCRIPTION

The Cable clip 2D is suitable to be attached to already existent (cabled) patch cords or can be ordered together with new patch cords as a pre-assembled addition. Each cable clip can be moved to an easily readable position. No slipping down from a "hanging" patch cord. Text on self-laminating label. Its design makes it suitable for bar code labelling.

Versions:

- Cable clip 2D to be attached to both sides of an existent patch cord (can also be attached to already connected patch cord - see fig. 1)
- Cable clips 2D, pre-assembled to a newly ordered patch cord, optional with standard serial number and 2D bar code (see fig. 2) or with customised text (see fig. 3) and/or 2D bar code (available on request)

MATERIAL

PVC

DIMENSIONS

W x H x D: 28 x 10 x 10 mm

SUITABLE CABLES

Round cables with 3.0 mm up to 5.8 mm external diameter, oval cables with 4.8 x 3.2 mm up to 6.6 x 4.0 mm.

COLOUR

white, similar to RAL 9010

Article No.	Description	PU
400312	Cable clip 2D (to be attached to existent patch cords) without self-laminating label (1 set = 50 pcs.)	1 set

Patch cord with pre-assembled Cable clips 2D

Note: Please order the requested patch cord separately - and please do not forget to mention the requested Cable clip 2D version when ordering!

400310	Cable clip 2D with label with standard serial number and 2D bar code (2 pcs. per patch cord, pre-assembled)	1 pc.
400311	Cable clip 2D with label with customised text (2 pcs. per patch cord, pre-assembled)	1 pc.

GG45™ connector system, Category 7_A

Module PS-GG45 7_A shielded

"Two-in-One" connector
backward compatible to RJ45



Keystone clip



Module PS-GG45 7_A
1000 MHz shielded



Termination tool for PS-GG45

PRODUCT INFORMATION

APPLICATION

The module PS-GG45 7_A is a shielded module, compatible with RJ45 and specified up to 1000 MHz. It was developed especially for applications beyond 10-gigabit Ethernet with highest bandwidths. When used together with Cat. 7_A data cables and patch cords, it enables to fulfil all Class F_A requirements for the 4-conductor Channel in accordance with ISO/IEC 11801 Amendment 1:2008. The "Two-in-One" module has 12 contacts that work in two different transmission modes: Standard = RJ45 and High-Speed = GG45.

DESCRIPTION

Robust zinc die casting housing with Keystone clip for easy installation in patch panels and faceplates with Keystone openings.
Quick and reliable wire-connections with the termination tool for GG45.
Depending on the plug that is used (RJ45 or GG45) there are 8 out of 12 contacts enabled:

- the RJ45 plug uses the 8 contacts on the top-level,
- the GG45 plug enables the 8 contacts in the upper and lower corners.

The 360° braid connection supplies best Coupling Attenuation values and provides for immunity against Alien Crosstalk or other external influences.

MECHANICAL PROPERTIES

Solid copper wire	0.51 mm (AWG 24) to 0.65 mm (AWG 22)
Diameter over insulation	0.7 mm to 1.4 mm (1.6 mm)
Version for stranded copper wire	AWG 24 up to AWG 27
Stranded wire	7 bare stranded wires

STANDARDS

IEC 60603-7-71 (Cat. 7_A shielded, 1000 MHz)
ISO/IEC 11801:2002 / Amd.2:2010
EN 50173-1:2011

GENERAL CHARACTERISTICS

Termination	Pair configuration according to T568- A or T568-B, clearly marked with a colour code
Mounting	Suitable for Keystone openings in accordance with ISO/IEC 60603-7
 Category/Class	Cat. 7 _A / Class F _A

Article No.	Description	Colour	PU
400102	Module PS-GG45 7 _A 4P Two-in-One shielded	metal	10 pcs.
400103	Module PS-GG45 7 _A 4P Two-in-One shielded, for stranded wires	metal	10 pcs.
400105	Termination tool for PS-GG45	red	1 pc.

GG45™ is a registered trademark of NEXANS

Please find an up-to-date matrix showing which patch panels, faceplates and outlets are suitable for the insertion of the respective Datwyler module on our website: www.cabling.datwyler.com.

Subject to technical modification.



Module PS-TERA 4P Cat. 7_A



Plug PS-TERA 4P, 2P, 1P shielded
Plug PS-TERA 1P unshielded



PS-TERA tool
For easy cable preparation



Parallel pliers

PRODUCT INFORMATION

FEATURES

The module PS-TERA is a shielded module that accepts 1-pair, 2-pair and 4-pair plugs. It fulfils all requirements for Cat. 7_A products up to 1000 MHz in accordance with IEC 61076-3-104. Therefore the module is suitable for 10-gigabit Ethernet transmissions in accordance with IEEE 802.3an and for upcoming applications that need even higher bandwidths. The module is intended for screened Cat.7 or 7_A data cable termination. As it accepts 1-, 2- or 4-pair plugs, it enables the transmission of multiple applications over one data cable at the same time (Plug Sharing). The plugged-in plugs are interlocked. Datwyler offers coloured cable boots for the differentiation of applications. Unused modules are protected with hinged dust shutters. The module is compatible with the wire diameters AWG 22 to AWG 23.

APPLICABLE STANDARDS

IEC 61076-3-104 (Cat. 7_A shielded, 1000 MHz)
ISO/IEC 11801:2002 / Amd.2:2010
EN 50173-1:2011

INFORMATION

The PS-TERA modules can be fitted in all Datwyler faceplates, patch panels or floor box solutions with MPS openings

GENERAL CHARACTERISTICS

Category/Class Cat. 7_A / Class F_A

Article No.	Description	Colour	PU/Set
1408502	Module PS-TERA 4P Cat. 7 _A /F _A 1000 MHz	black	1 pc.
1408503	Plug PS-TERA 4P Cat. 7 _A /F _A 1000 MHz	black	50 pcs.
1408504	Plug PS-TERA 2P	black	100 pcs.
1411985	Plug PS-TERA 1P	black	10 pcs.
1409554	Plug PS-TERA 1P unshielded (for telephone applications)	black	10 pcs.

more packaging units on request

ACCESSORIES

Article No.	Description	PU
1409210	PS-TERA tool for easy cable preparation	1 pc.
1412330	Parallel pliers for termination of modules	1 pc.

TERA™ is a registered Trademark of SIEMON

Please find an up-to-date matrix showing which patch panels, faceplates and outlets are suitable for the insertion of the respective Datwyler module on our website: www.cabling.datwyler.com.

Subject to technical modification.

RJ45 module, shielded, Category 6_A (IEC)

Module KS-T Plus 1/8 tool-less Cat. 6_A (IEC)



RJ45 module KS-T Plus 1/8 tool-less Cat. 6_A (IEC) shielded with dust shutter

PRODUCT INFORMATION

APPLICATION

For the transmission of digital and analogue voice-, video- and data signals. The module KS-T Plus is specified up to 500 MHz in compliance with the component standard IEC 60603-7-51. Enables acceptance testing with high spare capacity at the limit values stipulated for Class E_A Permanent Links when combined with shielded Category 6_A, 7 and 7_A data cables. Therefore it is applicable for 10-gigabit Ethernet transmissions in accordance with IEEE 802.3. Useable for Power over Ethernet Plus (PoE+) corresponding to IEEE 802.3at.

DESCRIPTION

Solid zinc die casting housing with mounting clip for installation in Keystone panels and outlets. Contact spring with phosphor bronze alloy, plated with gold. For connecting the wires a wire manager is used in combination with two integrated moveable housing wings for tool-less IDC connections. Only for cutting the wires a plane wire cutter is necessary. The 360° metal shield ensures a durable fully shielded environment. Strain relief via cable tie. The module is re-usable. Potential balancing possibility directly at the module when needed. With removable black dust shutter. Other colours available as accessories sets.



MECHANICAL PROPERTIES

Solid copper wire	0.50 mm (AWG 24) to 0.65 mm (AWG 22)
Re-connection	for AWG 22, AWG 23 and AWG 24 when using the same or bigger wire diameter
Stranded copper wire	CU 7702 flex (AWG 26/7), re-usable once
Diameter over insulation	0.70 mm to 1.40 mm (1.60 mm)
Temperature range	storing: -40° C to +70° C
	during installation: -10° C to +60° C
	in operation: -20° C to +60° C

STANDARDS

IEC 60603-7-51 (Cat. 6_A shielded, 500 MHz)
 ISO/IEC 11801:2002 / Amd.2:2010
 EN 50173-1:2011
 TIA/EIA 568-B.2-10:2008

GENERAL CHARACTERISTICS

Termination	Wire guides with colour coding in accordance with T568-A or B
 M	Modular
 Category/Class	Cat. 6 _A / Class E _A

Article No.	Description	Colour (similar to)	PU
418061	RJ45 module KS-T Plus 1/8 tool-less Cat. 6 _A (IEC) shielded, with dust shutter	black	10 pcs.
418062	Dust shutters for modules KS-T Cat. 6/E _A and KS-T Plus Cat. 6 _A (1 set = 10 pcs.)	white	1 set
418063	Dust shutters for modules KS-T Cat. 6/E _A and KS-T Plus Cat. 6 _A (1 set = 10 pcs.)	black	1 set
418064	Dust shutters for modules KS-T Cat. 6/E _A and KS-T Plus Cat. 6 _A (1 set = 10 pcs.)	yellow	1 set
418065	Dust shutters for modules KS-T Cat. 6/E _A and KS-T Plus Cat. 6 _A (1 set = 10 pcs.)	blue	1 set
418066	Dust shutters for modules KS-T Cat. 6/E _A and KS-T Plus Cat. 6 _A (1 set = 10 pcs.)	green	1 set
418067	Dust shutters for modules KS-T Cat. 6/E _A and KS-T Plus Cat. 6 _A (1 set = 10 pcs.)	red	1 set

Please find an up-to-date matrix showing which patch panels, faceplates and outlets are suitable for the insertion of the respective Datwyler module on our website: www.cabling.datwyler.com.

Subject to technical modification.



Module MS-K Plus 1/8 Cat. 6_A shielded



Dust shutters
Set with 25 pcs.

PRODUCT INFORMATION

APPLICATION	For the transmission of digital and analogue voice, video and data signals. The module MS-K Plus is specified up to 500 MHz in accordance with the component standard IEC 60 603-7-51. In combination with shielded Category 6 _A , 7 and 7 _A data cables all Class D, E and E _A applications are applicable, that is including 10GBase-T (IEEE 802.3an). Useable for Power over Ethernet Plus (PoE+) in accordance with IEEE 802.3at.	
DESCRIPTION	Compact zinc die casting housing. Special construction for high packing density in faceplates/outlets (up to 3 modules). Tool-less wire termination. 360° braid connection to the strain relief bar. Strain relief bar fixed with a cable tie. With snap-in mounting in patch panels and faceplates by a special kind of Keystone fitting (180° turned).	
MECHANICAL PROPERTIES	Solid copper wire Stranded copper wire Re-connection frequency Diameter over insulation Temperature range	0.51 mm (AWG 24) to 0.63 mm (AWG 22) dependent on construction ≤ 10 times when using the same or bigger wire diameter 0.7 to 1.4 mm (1.6 mm) storing: - 40° C to + 70° C during installation: - 10° C to + 60° C in operation: - 20° C to + 60° C
STANDARDS	IEC 60603-7-51 (Cat.6 _A shielded, 500 MHz) ISO/IEC 11801:2002 / Amd.2:2010 EN 50173-1:2011 TIA/EIA 568-B.2-10:2008	
GENERAL CHARACTERISTICS	Termination Potential balancing Mounting possibilities ■ Category/Class	Pair-configuration in accordance with TIA 568-A, clearly marked with a colour code 6.3 mm flat plug connection capability at the module Suitable for patch panel MS-K 24x and faceplates MS-K (2 or 3 port) Cat. 6 _A / Class E _A

Article No.	Description	Colour (similar to)	PU
440004	RJ45 module MS-K Plus 1/8 Cat. 6 _A (IEC), with colour code TIA 568-A	metal	10 pcs
OPTION 440005	RJ45 module MS-K Plus 1/8 Cat. 6 _A (IEC), with colour code TIA 568-B metal	metal	10 pcs
OPTION 440006	RJ45 module MS-N Plus 1/8 Cat. 6 _A (IEC), with colour code TIA 568-A	metal	10 pcs
417985	Dust shutter MS-K (1 set = 25 pcs)	grey	1 set
417986	Dust shutter MS-K (1 set = 25 pcs)	white, RAL 9010	1 set
440034	Dust shutter MS-K (1 set = 25 pcs)	red, RAL 3000	1 set
440035	Dust shutter MS-K (1 set = 25 pcs)	yellow, RAL 1021	1 set
440036	Dust shutter MS-K (1 set = 25 pcs)	blue, RAL 5015	1 set
440037	Dust shutter MS-K (1 set = 25 pcs)	green, RAL 6016	1 set
440038	Dust shutter MS-K (1 set = 25 pcs)	orange, RAL 2008	1 set
440039	Dust shutter MS-K (1 set = 25 pcs)	black, RAL 9005	1 set

Please find an up-to-date matrix showing which patch panels, faceplates and outlets are suitable for the insertion of the respective Datwyler module on our website: www.cabling.datwyler.com.

Subject to technical modification.

RJ45 module, shielded, Category 6_A (IEC)

Module MS-C6_A 1/8 Cat. 6_A (IEC) 180°

for 10-gigabit Ethernet



Dust shutters

PRODUCT INFORMATION

APPLICATION

For the transmission of digital and analogue voice, video and data signals. The module MS-C6_A is specified up to 500 MHz in accordance with the component standard IEC 60 603-7-51. In combination with shielded Cat.6_A, 7 and 7_A data cables all applications up to Class E_A are applicable, that is including 10GBase-T (IEEE 802.3an). Useable for PoE and Power over Ethernet Plus (PoE+) in accordance with IEEE 802.3at.

DESCRIPTION

Compact two-piece module, re-usable zinc die casting housing. Special construction for high packing density in faceplates/outlets (up to 3 modules). Tool-less, time-saving wire termination. Possibility to terminate solid and flexible cables. Outstanding electrical performance for 10-gigabit Ethernet applications. 360° braid connection to the strain relief bar. Strain relief via snap-in clip without cable tie.

MECHANICAL PROPERTIES

Wire connection	IDC insulation displacement connectors
Solid copper wire	0.50 mm (AWG 24/1) to 0.65 mm (AWG 22/1)
Stranded copper wire	AWG 26/7 to AWG 24/7, e.g. CU 7702 flex
Re-connection	feasible when using the same or bigger wire diameter
Diameter over insulation	0.7 mm to 1.4 mm (1.6 mm)
Temperature range	storing: - 40° C up to + 70° C
	during installation: - 10° C up to + 60° C
	in operation: - 20° C up to + 60° C

STANDARDS

IEC 60603-7-51 (Cat. 6_A shielded, 500 MHz)
ISO/IEC 11801:2002 / Amd.2:2010
EN 50173-1:2011
TIA/EIA 568-B.2-10:2008

GENERAL CHARACTERISTICS

Termination	Configuration in accordance with TIA 568-A and B, clearly marked with a colour code
Potential balancing	2.8 mm flat plug connection capability at the module
Mounting possibilities	Suitable for MS patch panels and MS faceplates/outlets
Category/Class	Cat. 6 _A / Class E _A

Article No.	Description	Colour (similar to)	PU
309250	Module MS-C6 _A 1/8 Cat. 6 _A (IEC) 180°	metal	10 pcs.
309240	Module MS-C6 _A 1/8 Cat. 6 _A (IEC) 180°	metal	100 pcs.
309248	Dust shutters	black	25 pcs.
309180	Dust shutters	white	25 pcs.
309181	Dust shutters	grey	25 pcs.
309182	Dust shutters	red	25 pcs.
309183	Dust shutters	yellow	25 pcs.
309184	Dust shutters	green	25 pcs.
309185	Dust shutters	blue	25 pcs.

Please find an up-to-date matrix showing which patch panels, faceplates and outlets are suitable for the insertion of the respective Datwyler module on our website: www.cabling.datwyler.com.

Subject to technical modification.



Module MS-C6_A 1/8 Cat. 6_A (IEC) 180°-K (Keystone) Dust shutters

PRODUCT INFORMATION

APPLICATION	For the transmission of digital and analogue voice, video and data signals. The module MS-C6 _A 1/8 Cat. 6 _A (IEC) 180°-K (Keystone) is specified up to 500 MHz in accordance with the component standard IEC 60 603-7-51. In combination with shielded Category 6 _A , 7 and 7 _A data cables all applications up to Class E _A are applicable, that is including 10GBase-T (IEEE 802.3an). Useable for PoE and Power over Ethernet Plus (PoE+) in accordance with IEEE 802.3at.	
DESCRIPTION	Compact two-piece module, re-usable zinc die casting housing. Special construction for high packing density in faceplates/outlets (up to 3 modules). Tool-less, time-saving wire termination. Possibility to terminate solid and flexible cables. Outstanding electrical performance for 10-gigabit Ethernet applications. 360° braid connection to the strain relief bar. Strain relief via snap-in clip without cable tie.	
MECHANICAL PROPERTIES	Wire connection Solid copper wire Stranded copper wire Re-connection Diameter over insulation Temperature range	IDC insulation displacement connectors 0.50 mm (AWG 24/1) to 0.65 mm (AWG 22/1) AWG 26/7 to AWG 24/7, e.g. CU 7702 flex feasible when using the same or bigger wire diameter 0.7 mm to 1.4 mm (1.6 mm) storing: - 40° C up to + 70° C during installation: - 10° C up to + 60° C in operation: - 20° C up to + 60° C
STANDARDS	IEC 60603-7-51 (Cat. 6 _A geschirmt, 500 MHz) ISO/IEC 11801:2002 / Amd.2:2010 EN 50173-1:2011 TIA/EIA 568-B.2-10:2008	
GENERAL CHARACTERISTICS	Termination Potential balancing Mounting possibilities Category/Class	Configuration in accordance with TIA 568-A and B, clearly marked with a colour code 2.8 mm flat plug connection capability at the module Suitable for Keystone patch panels and Keystone faceplates/outlets Cat. 6 _A / Class E _A

Article No.	Description	Colour (similar to)	PU
309249	Module MS-C6 _A 1/8 Cat. 6 _A (IEC) 180°-K (Keystone)	metal	10 pcs.
309239	Module MS-C6 _A 1/8 Cat. 6 _A (IEC) 180°-K (Keystone)	metal	100 pcs.
309248	Dust shutters	black	25 pcs.
309180	Dust shutters	white	25 pcs.
309181	Dust shutters	grey	25 pcs.
309182	Dust shutters	red	25 pcs.
309183	Dust shutters	yellow	25 pcs.
309184	Dust shutters	green	25 pcs.
309185	Dust shutters	blue	25 pcs.

Please find an up-to-date matrix showing which patch panels, faceplates and outlets are suitable for the insertion of the respective Datwyler module on our website: www.cabling.datwyler.com.

Subject to technical modification.

UP-K Outlet CSA Plus 2/8 (1/8), shielded, Category 6_A flush / duct mounted & floor boxes

with 1 or 2 RJ45 jacks Cat. 6_A (IEC) shielded, angled

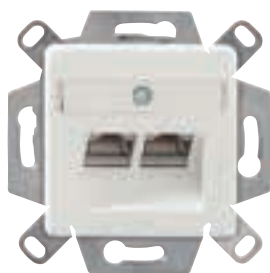

Fig. 1:
Data outlet
CSA Plus 2/8 Cat. 6_A
with central plate



Fig. 2:
Data outlet
CSA Plus 1/8 Cat. 6_A
with central plate



Fig. 3:
Termination tool 110



Fig. 4:
Cover frame 80 x 80 mm

PRODUCT INFORMATION

DESCRIPTION

Data outlet CSA Plus Cat. 6_A shielded, angled, for the transmission of digital and analogue voice, video and data signals up to 10-gigabit Ethernet in accordance with IEEE 802.3 - provides high spare capacities to the limit values.

Exceeds the requirements for Category 6_A connecting components (up to 500 MHz) as defined in ISO/IEC 60603-7-51.

Applicable for Power over Ethernet (PoE) / PoE+ in accordance with IEEE 802.3at.

Compact design for easy flush or duct mounting and deployment in floor boxes.

Can be used in combination with design families from many vendors.

Housing made of zinc die casting.

Cable feed from all sides (+/- 30° angle).

Combined shielding contact and strain relief.

LSA connection technology for copper wires from 0.4 mm up to 0.63 mm (AWG26 - AWG22), diameters over insulation from 0.7 mm up to 1.6 mm (PE).

Convenient head on wire termination.

Color code in accordance with T568-A and T568-B.

Temperature range from - 40° C up to + 70° C.

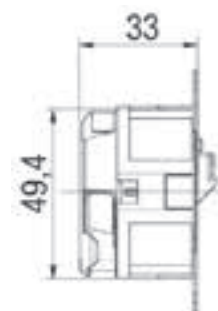

DIMENSIONS

70 x 70 x 47 mm (incl. central plate)

APPLICABLE STANDARDS

IEC 60603-7-51 (Cat. 6_A shielded, 500 MHz)

ISO/IEC 11801:2002 / Amd.2:2010

EN 50173-1:2011

TIA/EIA 568-B.2-10:2008

GENERAL PROPERTIES



EMC

shielded



Category/Class

Cat. 6_A / Class E_A



Article No.	Fig.	Description	Colour (similar to)	PU
435060	1	UP-K Data outlet CSA Plus 2/8 Cat. 6 _A (IEC), with central plate	pure white, RAL 9010	1 pc.
435067	2	UP-K Data outlet CSA Plus 1/8 Cat. 6 _A (IEC), with central plate	pure white, RAL 9010	1 pc.
1400830	4	Cover frame for data outlet CSD 2/8, 80 x 80 mm	pure white, RAL 9010	10 pcs.
417976	-	Central plate (50 x 50mm) for CSA Plus 2/8	oyster white, RAL 1013	10 pcs.
417979	-	Central plate (50 x 50mm) for CSA Plus 1/8	oyster white, RAL 1013	10 pcs.

Article No.	Description	PU
185896	3 IDC termination tool 110 (recommended for outlets CSD, patch panels CSP and CUP, and for KS modules)	1 pc.
	on request Assembly holders for mounting outlets in cable ducts	

Additional assembly tools / accessories can be found in the chapter System Accessories.

Patch panel CSA Plus 24/8, shielded, Category 6_A (IEC)with 24 RJ45 jacks
suitable for 10GBase-TPatch panel CSA Plus 24/8 Cat. 6_A (IEC), shielded

PRODUCT INFORMATION

APPLICATION	Shielded 19"/1U patchpanel for the transmission of digital and analogues voice, video and data signals. When used together with Cat. 6 _A , 7 or 7 _A data cables the patch panel is suitable for all applications up to Class E _A (500 MHz), including 10-gigabit Ethernet. Designed to keep the electromagnetic influence of adjacent data cables as small as possible and to fulfil the required Allien Crosstalk limit values. Applicable for Power over Ethernet (PoE) / PoE+ in accordance with IEEE 802.3at.	
CONSTRUCTION	Housing:	Solid metal, grey, similar to RAL 7035; simultaneous cover attachment and shielding contact using two screws
	Boards:	4 base boards, each with 6 LSA Plus terminal blocks and 6 RJ45 sockets
	Screen tap:	360° shielding via cable clip
	Strain relief:	with cable clip and a tie wrap
	A termination aid is available as an optional accessory. This consists of two angular sheets that can easily be fixed to the frame or cabinet and make the cable termination more comfortable.	
CONNECTION SYSTEM	Cable:	LSA Plus punch down contacts for copper wires AWG22 up to AWG26
	Socket:	Shielded RJ45 connector (tested up to 500 MHz)
APPLICABLE STANDARDS	IEC 60603-7-51 (Cat. 6 _A shielded, 500 MHz) ISO/IEC 11801:2002 / Amd.2:2010 EN 50173-1:2011 TIA/EIA 568-B.2-10:2008	
TERMINATION	Wire termination in accordance with T568A or T568B, colour coded	
GENERAL PROPERTIES	 EMC	shielded
	 Category/Class	Cat. 6 _A / Class E _A

Article No.	Description	Colour (similar to)	PU
417980	Patch panel CSA Plus 24/8 with 24x RJ45 jack Cat. 6 _A (IEC)	RAL 7035	1 pc.
417985	Dust shutter for retrofitting (1 set = 24 pcs)	grey	1 set

Article No.	Accessories/Description	PU
1401624	Patch panel termination aid (1 set = 2 angular sheets)	1 set
1401609	LSA Plus termination tool for LSA punch down contacts	1 pc.

Additional assembly tools / accessories can be found in the chapter System Accessories.

RJ45 module, shielded, Category 6/E_A

Module KS-T 1/8 tool-less Cat. 6/E_A



RJ45 module KS-T 1/8 tool-less Cat. 6/E_A with dust shutter

PRODUCT INFORMATION

APPLICATION

For the transmission of digital and analogue voice-, video- and data signals. The module KS-T exceeds the IEC 60603-7-5 standard's requirements for Cat.6 connecting hardware up to 250 MHz. It also fulfils all Class E_A Channel requirements up to 500 MHz when combined with Cat. 7 or Cat. 7_A data cables. Therefore it is applicable for 10-gigabit Ethernet transmissions in accordance with IEEE 802.3. Useable for Power over Ethernet Plus (PoE+) corresponding to IEEE 802.3at.

DESCRIPTION

Solid zinc die casting housing with mounting clip for installation in Keystone panels and outlets. Contact spring with phosphor bronze alloy, plated with gold. For connecting the wires a wire manager is used in combination with two integrated moveable housing wings for tool-less IDC connections. Only for cutting the wires a plane wire cutter is necessary. The 360° metal shield ensures a durable fully shielded environment. Strain relief via cable tie. The module is re-usable. Potential balancing possibility directly at the module when needed. With removable black dust shutter. Other colours available as accessories sets.



MECHANICAL PROPERTIES

Solid copper wire	0.50 mm (AWG 24) to 0.65 mm (AWG 22)
Re-connection	for AWG 22, AWG 23 and AWG 24 when using the same or bigger wire diameter
Stranded copper wire	CU 7702 flex (AWG 26/7), re-usable once
Diameter over insulation	0.70 mm to 1.40 mm (1.60 mm)
Temperature range	storing: - 40° C to + 70° C during installation: - 10° C to + 60° C in operation: - 20° C to + 60° C

STANDARDS

IEC 60603-7-5 (Cat. 6 shielded, 250 MHz)
ISO/IEC 11801:2002 / Amd.2:2010
EN 50173-1:2011
TIA/EIA 568-B.2-10:2008

GENERAL CHARACTERISTICS

Termination	Wire guides with colour coding in accordance with T568-A or T568-B
 M	Modular
 Category/Class	Cat. 6 / Class E _A (Channel) when used together with Category 7 or 7 _A data cables



Article No.	Description	Colour	PU
418060	RJ45 module KS-T 1/8 tool-less Cat. 6/E _A shielded with dust shutter	black	10 pcs.
418062	Dust shutters for modules KS-T Cat. 6/E _A and KS-T Plus Cat. 6 _A (1 set = 10 pcs.)	white	1 set
418063	Dust shutters for modules KS-T Cat. 6/E _A and KS-T Plus Cat. 6 _A (1 set = 10 pcs.)	black	1 set
418064	Dust shutters for modules KS-T Cat. 6/E _A and KS-T Plus Cat. 6 _A (1 set = 10 pcs.)	yellow	1 set
418065	Dust shutters for modules KS-T Cat. 6/E _A and KS-T Plus Cat. 6 _A (1 set = 10 pcs.)	blue	1 set
418066	Dust shutters for modules KS-T Cat. 6/E _A and KS-T Plus Cat. 6 _A (1 set = 10 pcs.)	green	1 set
418067	Dust shutters for modules KS-T Cat. 6/E _A and KS-T Plus Cat. 6 _A (1 set = 10 pcs.)	red	1 set

Please find an up-to-date matrix showing which patch panels, faceplates and outlets are suitable for the insertion of the respective Datwyler module on our website: www.cabling.datwyler.com.

Subject to technical modification.

RJ45 module KS-TS 1/8 tool-less slimline Cat. 6/E_A

PRODUCT INFORMATION

APPLICATION	<p>For the transmission of digital and analogue voice-, video- and data signals. The module KS-TS is designed to shorten the termination and installation times. It exceeds the IEC 60603-7-5 standard's requirements for Cat. 6 connecting hardware up to 250 MHz. It also fulfils all Class E_A Channel requirements up to 500 MHz when combined with Cat. 7 or Cat. 7_A data cables. Therefore it is applicable for 10-gigabit Ethernet transmissions in accordance with IEEE 802.3. Useable for Power over Ethernet Plus (PoE+) corresponding to IEEE 802.3at.</p>	
DESCRIPTION	<p>Solid zinc die casting housing with mounting clip for installation in Keystone panels and outlets. Compact construction for high packing density in faceplates/outlets (up to 3 modules). Contact spring with phosphor bronze alloy, plated with gold. For connecting the wires a wire manager is used in combination with two integrated moveable housing wings for tool-less IDC connections. Only for cutting the wires a plane wire cutter is necessary. Strain relief via cable tie. The module is re-usable.</p>	
MECHANICAL PROPERTIES	<p>Solid copper wire Re-connection</p> <p>Stranded copper wire Diameter over insulation Temperature range</p>	<p>0.50 mm (AWG 24) to 0.65 mm (AWG 22), for AWG 22, AWG 23 and AWG 24 when using the same or bigger wire diameter</p> <p>CU 7702 flex (AWG 26/7), re-usable once</p> <p>0.7 mm to 1.4 mm (1.6 mm)</p> <p>storing: - 40° C to + 70° C during installation: - 10° C to + 60° C in operation: - 10° C to + 60° C</p>
DIMENSIONS	Width x Height x Length	14,6 mm x 23,2 mm x 39,8 mm (slimline)
STANDARDS	<p>IEC 60603-7-5 (Cat. 6 shielded, 250 MHz) ISO/IEC 11801:2002 / Amd.2:2010 EN 50173-1:2011 TIA/EIA 568-B.2-10:2008</p>	
GENERAL CHARACTERISTICS	<p>Termination  M  Category/Class</p>	<p>Wire guides with colour coding in accordance with T568-A or T568-B Modular Cat. 6 / Class E_A (Channel) when used together with Category 7 or 7_A data cables</p>

Article No.	Description	Colour	PU
418054	RJ45 module KS-TS 1/8 tool-less slimline Cat. 6/E _A shielded	metal	10 pcs.

RJ45 module, shielded, Category 6/E_A

Module MS 1/8 Cat. 6/E_A
for 10-Gigabit Ethernet

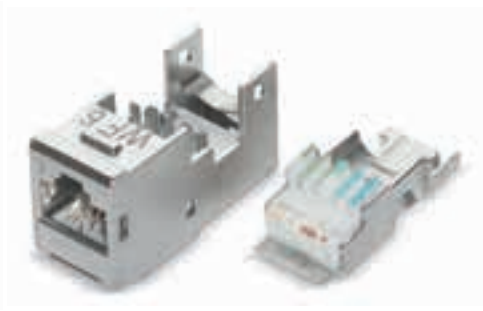

Module MS 1/8 Cat. 6/E_A shielded

Parallel pliers for easy termination

PRODUCT INFORMATION

APPLICATION

For the transmission of digital and analogue voice, video and data signals.
The module MS 1/8 exceeds the IEC 60603-7-5 standard's requirements for Category 6 connecting hardware up to 250 MHz. It also fulfils all Class E_A Channel requirements up to 500 MHz when combined with Cat. 7 or Cat. 7_A data cables. Therefore it is applicable for 10-gigabit Ethernet transmissions in accordance with IEEE 802.3.
Useable for Power over Ethernet Plus (PoE+) corresponding to IEEE 802.3at.

DESCRIPTION

Compact zinc die casting housing.
360° screen connection with flat plug connector for potential balancing.
Integrated strain relief (cable tie).
High packing density due to very small dimension.
Stable mounting in patch panels and data outlets with a metal spring at the module.

MECHANICAL PROPERTIES

Solid copper wire	0.40 mm (AWG 26) to 0.65 mm (AWG 22)
Stranded copper wire	AWG 26/7 (with 7 bare stranded wires)
Re-connection	for AWG 22, AWG 23 and AWG 24 when using the same or bigger wire diameter
Diameter over insulation	0.70 mm to 1.40 mm (1.60 mm)
Temperature range	storing: - 40° C to + 70° C
	during installation: - 10° C to + 60° C
	in operation: - 10° C to + 60° C

STANDARDS

IEC 60603-7-5 (Cat. 6 shielded, 250 MHz)
ISO/IEC 11801:2002 / Amd.2:2010
EN 50173-1:2011
TIA/EIA 568-B.2-10:2008

GENERAL CHARACTERISTICS

Termination	Wire guides with colour coding in accordance with T568-A and T568-B
 Category/Class	Cat. 6 / Class E _A (Channel) when used together with Category 7 or 7 _A data cables

Article No.	Description	Colour	PU
185700	RJ45 module MS 1/8 Cat. 6/E _A shielded,with colour code TIA 568-A	metal	10 pcs.
385700	RJ45 module MS 1/8 Cat. 6/E _A shielded,with colour code TIA 568-A	metal	100 pcs.
1414227	RJ45 module MS 1/8 Cat. 6/E _A shielded,with colour code TIA 568-B	metal	10 pcs
1412330	Paralleleinpresszange zur Montage der Module MS 1/8		1 pc.

Please find an up-to-date matrix showing which patch panels, faceplates and outlets are suitable for the insertion of the respective Datwyler module on our website: www.cabling.datwyler.com.

Subject to technical modification.



RJ45 module KS-TA 1/8 Cat. 6/E_A,
shielded, 45° angled



Patch panel KS 24x-s, 19"/1U, shielded

PRODUCT INFORMATION

APPLICATION

For the transmission of digital and analogue voice-, video- and data signals.
The module KS-TA exceeds the IEC 60603-7-5 standard's requirements for Cat. 6 connecting hardware up to 250 MHz.
It also fulfils all Class E_A Permanent-Link (PL) requirements up to 500 MHz when combined with Category 7 or 7_A data cables. Therefore it is applicable for 10-Gigabit Ethernet transmissions in accordance with IEEE 802.3.
Useable for Power over Ethernet Plus (PoE+) corresponding to IEEE 802.3at.
The module KS-TA is suitable for the patch panel KS24x-s (Article No. 418023) only.
Due to the module's 45 degree angled front patch connections can be made diagonally from left and right.

DESCRIPTION

Solid zinc die casting housing with mounting clip for installation in Keystone panel KS 24x-s.
Contact spring with phosphor bronze alloy, plated with gold.
For connecting the wires a wire manager is used in combination with two integrated moveable housing wings for tool-less IDC connections.
Only for cutting the wires a plane wire cutter is necessary.
Strain relief via cable tie.
The module is re-usable.

MECHANICAL PROPERTIES

Solid copper wire	0.50 mm (AWG 24) to 0.65 mm (AWG 22)
Re-connection	for AWG 22, AWG 23 and AWG 24 when using the same or bigger wire diameter
Stranded copper wire	CU 7702 flex (AWG 26/7), re-usable once
Diameter over insulation	0.70 mm to 1.40 mm (1.60 mm)
Temperature range	storing: - 40° C to + 70° C
	during installation: - 10° C to + 60° C
	in operation: - 20° C to + 60° C

STANDARDS

IEC 60603-7-5 (Cat. 6 shielded, 250 MHz)
ISO/IEC 11801:2002 / Amd. 2:2010
EN 50173-1:2011
TIA/EIA 568-B.2-10:2008

GENERAL CHARACTERISTICS

Termination	Wire guides with colour coding in accordance with T568-A or T568-B
Category/Class	Cat. 6 / Class E _A (Channel) when used together with Category 7 or 7 _A data cables

Article No.	Description	Colour (similar to)	PU
418068	RJ45 module KS-TA 1/8 Cat. 6/E _A , shielded, 45° degree angled	metal	10 pcs.
418023	Patch panel KS 24x-s, 19"/1U, shielded	black, RAL 9005	1 pc.

Patch panel CSP 24/8, shielded, Category 6 with 24 RJ45 jacks



Patch panel CSP 24/8 Cat. 6, shielded

PRODUCT INFORMATION

APPLICATION Shielded 19"/1U patchpanel for the transmission of digital and analogue voice and data signals. Especially suited for all Class E applications in accordance with EN 50173-1 and ISO/IEC 11801. Applicable for Power over Ethernet (PoE) / PoE+ in accordance with IEEE 802.3at.

CONSTRUCTION

Housing:	Solid metal, front grey, similar to RAL 7035 (black on request); simultaneous cover attachment and shielding contact using two screws
Boards:	3 base boards, each with 8 LSA terminal blocks and 8 RJ45 sockets
Screen tap:	360° screening by ground clips
Strain relief:	with tie wrap
Dimensions:	19"/1U, W x D x H = 482 mm x 96 mm x 44 mm

A termination aid is available as an optional accessory. This consists of two angular sheets that can easily be fixed to the frame or cabinet and make the cable termination more comfortable.

CONNECTION SYSTEM

Cable:	LSA Plus punch down contacts
Socket:	Shielded RJ45 connector (Cat.6, 250 MHz)

APPLICABLE STANDARDS

IEC 60603-7-5 (Cat. 6 shielded, 250 MHz)
 ISO/IEC 11801:2002 / Amd.2:2010
 EN 50173-1:2011
 TIA/EIA 568-B.2-10:2008

TERMINATION Wire termination in accordance with TIA-A and TIA-B, colour coded

GENERAL PROPERTIES

 EMC	shielded
 Category/Class	Cat. 6 / Class E

Article No.	Description	Colour (similar to)	PU
418006	Patch panel CSP 24/8 Cat. 6 shielded	grey, RAL 7035	1 pc.
on request	Patch panel CSP 24/8 Cat. 6 shielded	black, RAL 9005	1 pc.

Article No.	Accessories/Description	PU
1401624	Patch panel termination aid (1 set = 2 angular sheets)	1 set
185896	IDC termination tool 110 (recommended for outlet CSD, patch panels CSP and CUP, and for KS modules)	1 pc.
1401609	LSA Plus termination tool for LSA punch down contacts	1 pc.

Additional assembly tools / accessories can be found in the chapter System Accessories

CSP 24/8 0714/e







RJ45 Keystone coupler, shielded

Cat. 6 Link / Class E, 180° (straight)



RJ45 Keystone Coupler (RJ45-RJ45), 180° (straight)

PRODUCT INFORMATION

APPLICATION	Suitable for setting up Consolidation Points and cross-connect wirings. For the transmission of all digital and analogue applications up to Cat. 6 (Link) / Class E in accordance with ISO/IEC 11801, EN 50173-1 and EIA/TIA 568-B.2-10.				
DESCRIPTION	Compact zinc die casting housing Small depth Straight design (180 degrees) With keystone fixing applicable e.g. in patch panel KS 24x				
STANDARDS	IEC 60603-7-5 (Cat. 6 shielded, 250 MHz) ISO/IEC 11801:2002 / Amd.2:2010 EN 50173-1:2011 TIA/EIA 568-B.2-10:2008				
GENERAL CHARACTERISTICS	<table border="0" style="width: 100%;"> <tr> <td style="width: 50%;"> M Modular</td> <td style="width: 50%;">Modular</td> </tr> <tr> <td> Category/Class</td> <td>Cat.6 / Class E</td> </tr> </table>	 M Modular	Modular	 Category/Class	Cat.6 / Class E
 M Modular	Modular				
 Category/Class	Cat.6 / Class E				
DIMENSIONS	Straight design (180 degrees)				

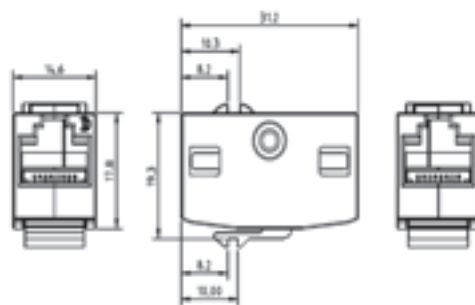

Article No.	Description	Colour	PU
418056	RJ45 Keystone Coupler, Cat. 6 Link / Class E, 180° (straight)	metal	1 pc.

Please find an up-to-date matrix showing which patch panels, faceplates and outlets are suitable for the insertion of the respective Datwyler module on our website: www.cabling.datwyler.com.

Subject to technical modification.

RJ45 feed-through coupler, shielded

Cat. 6 Link / Class E, 90° angled / 180° (straight)



Side 1:
MS fitting

Side 2:
Keystone fitting



Side 1:
MS fitting



Side 2:
Keystone fitting

PRODUCT INFORMATION

APPLICATION

Suitable for setting up Consolidation Points and cross-connect wirings.
For the transmission of all digital and analogue applications up to Cat. 6 (Link) / Class E in accordance with ISO/IEC 11801, EN 50173-1 and EIA/TIA 568-B.2-10.

DESCRIPTION

Compact zinc die casting housing.
Angled model with small depth.
Two types of mounting in one coupling:
side 1 with MS fitting (straight variant, e.g. for usage in patch panel MPS 24x),
side 2 with Keystone fitting (straight variant, e.g. for usage in patch panel KS 24x).
Manufacturer: BTR.

STANDARDS

IEC 60603-7-5 (Cat.6 shielded, 250 MHz)
ISO/IEC 11801:2002 / Amd.2:2010
EN 50173-1:2011
TIA/EIA 568-B.2-10:2008

GENERAL CHARACTERISTICS

 M	Modular
 Category/Class	Cat. 6 (Link) / Class E

DIMENSIONS

Angled design (90 degrees)

Straight design (180 degrees)

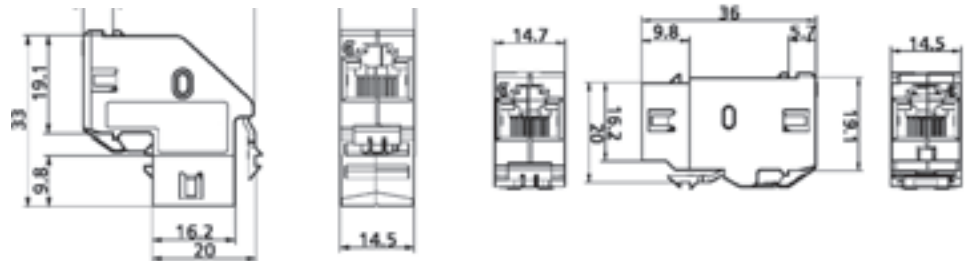

Article No.	Description	Colour	PU
417445	RJ45 feed-through coupler, Cat. 6 Link / Class E, 90° angled	metal	1 pc.
417446	RJ45 feed-through coupler, Cat. 6 Link / Class E, 180° (straight)	metal	1 pc.

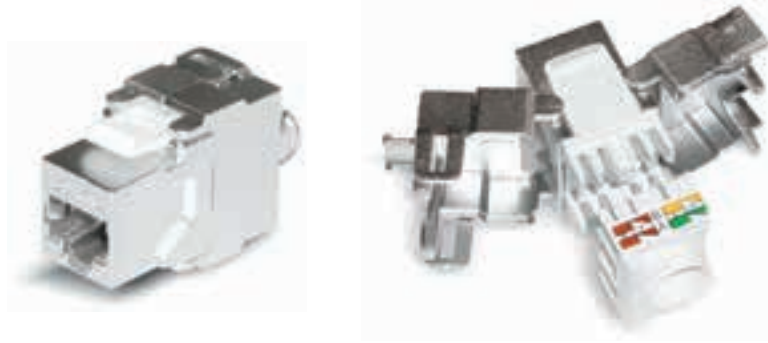

Please find an up-to-date matrix showing which patch panels, faceplates and outlets are suitable for the insertion of the respective Datwyler module on our website: www.cabling.datwyler.com.

Subject to technical modification.



Module KS-T 5 1/8 tool-less Cat. 5e shielded

PRODUCT INFORMATION

APPLICATION	KS-T 5 1/8 tool-less is a module that is designed to shorten the termination and installation time. For the transmission of digital and analogue voice, video and data signals. Applicable for the transmission of all applications up to Class D (e. g. 1GBase-T).	
DESCRIPTION	Solid zinc die casting housing with mounting clip for installation in Keystone panels and outlets. Contact spring with phosphor bronze alloy, plated with gold. For connecting the wires a wire manager is used in combination with two integrated moveable housing wings for tool-less IDC connections. Only for cutting the wires a plane wire cutter is necessary. The 360° metal shield protects the module and guarantees stable electric performance. Strain relief via cable tie. The module is re-usable.	
MECHANICAL PROPERTIES	Solid copper wire Re-connection	0.50 mm (AWG 24) to 0.65 mm (AWG 22) for AWG 22, AWG 23 and AWG 24 when using the same or bigger wire diameter
	Stranded copper wire Diameter over insulation Temperature range	AWG 26/7, re-usable once 0.7 mm to 1.4 mm (1.6 mm) storing: - 40° C to + 70° C during installation: - 10° C to + 60° C in operation: - 10° C to + 60° C
STANDARDS	IEC 60603-7-3 (Cat. 5 shielded, 100 MHz) ISO/IEC 11801:2002 / Amd.2:2010 EN 50173-1:2011 TIA/EIA 568-B.2-10:2008	
GENERAL CHARACTERISTICS	Termination  M  Category/Class	Wire guides with colour coding in accordance with T568-A or T568-B Modular Cat. 5/5e / Class D

Article No.	Description	Colour	PU
418055	RJ45 module KS-T 5 1/8 tool-less Cat. 5e shielded	metal	10 pcs.

RJ45 module, unshielded, Category 6
RJ45 module, unshielded, Category 5e
 Module KU-T 1/8 tool-less, Cat. 6 and Cat. 5e



RJ45 modules KU-T 1/8 tool-less unshielded
 Cat. 6 or Cat. 5e, in white or black

PRODUCT INFORMATION

APPLICATION

For the transmission of digital and analogue voice, video and data signals.
 Suitable for all Class D applications respectively Class E Channels in accordance with ISO/IEC 11801, EN 50173-1 and TIA/EIA 568-B.2-10.

DESCRIPTION

Housing made of high-impact resistant, flame retardant compound, UL94V-0 rated, with Keystone mounting clip.
 Contact spring with phosphor bronze alloy, plated with gold.
 IDC made of phosphor bronze alloy.

Information:

Suitable for the same faceplates and surface mount boxes as Datwyler's shielded Keystone modules (KS-T).



MECHANICAL PROPERTIES

Solid copper wire	0.40 mm (AWG 26) to 0.65 mm (AWG 22)
Re-connection	for AWG 22, AWG 23 and AWG 24 when using the same or bigger wire diameter
Stranded copper wire	AWG 26 (with 7 bare stranded wires), re-usable once
Diameter over insulation	0.70 mm to 1.40 mm (1.60 mm)
Temperature range	storing: - 40° C to + 70° C
	during installation: - 10° C to + 60° C
	in operation: - 20° C to + 60° C

STANDARDS

IEC 60603-7-2 (Cat. 5 unshielded, 100 MHz)
 IEC 60603-7-4 (Cat. 6 unshielded, 250 MHz)
 ISO/IEC 11801:2002/ Amd.2:2010
 EN 50173-1:2011
 TIA/EIA 568-B.2-10:2008

GENERAL CHARACTERISTICS

Termination	Wire guides with colour coding in accordance with T568-A and B, clearly marked on the wire manager
 Category/Class	Cat. 5e / Class D
 Category/Class	Cat. 6 / Class E

Article No.	Description	Colour	PU
418070	RJ45 module KU-T 1/8 tool-less, Cat. 6, unshielded	white	10 pcs.
418071	RJ45 module KU-T 1/8 tool-less, Cat. 6, unshielded	black	10 pcs.
418072	RJ45 module KU-T 1/8 tool-less, Cat. 5e, unshielded	white	10 pcs.
418073	RJ45 module KU-T 1/8 tool-less, Cat. 5e, unshielded	black	10 pcs.

Please find an up-to-date matrix showing which patch panels, faceplates and outlets are suitable for the insertion of the respective Datwyler module on our website: www.cabling.datwyler.com.

Subject to technical modification.



RJ45 module MU 1/8 Cat. 6 unshielded



Parallel pliers for easy termination

PRODUCT INFORMATION

APPLICATION	For the transmission of digital and analogue voice, video and data signals. Especially suitable for all Class E applications in accordance with ISO/IEC 11801, EN 50173-1.	
DESCRIPTION	Compact plastic housing. Very easy termination due to a wire manager and IDC connections. Integrated strain relief (cable tie - not included). High packing density due to very small dimensions.	
	Information: Suitable for the same faceplates and surface mount boxes as Datwyler's shielded MS modules.	
MECHANICAL PROPERTIES	Solid copper wire Stranded copper wire Re-connection	0.40 mm (AWG 26) to 0.65 mm (AWG 22) AWG 26/7 (with 7 bare stranded wires) for AWG 22, AWG 23 and AWG 24 when using the same or bigger wire diameters
	Diameter over insulation Temperature range	0.70 mm to 1.40 mm (1.60 mm) storing: - 40° C to + 70° C during installation: - 10° C to + 60° C in operation: - 10° C to + 60° C
STANDARDS	IEC 60603-7-4 (Cat. 6 unshielded, 250 MHz) ISO/IEC 11801:2002/ Amd.2:2010 EN 50173-1:2011 TIA/EIA 568-B.2-10:2008	
GENERAL CHARACTERISTICS	Termination ■ Category/Class	Colour code for wire termination in accordance with T568-A or B, clearly marked on cable manager Cat. 6 / Class E

Article No.	Description	Colour	PU
185750	RJ45 module MU 1/8 Cat. 6, unshielded, colour code T568-A	white	10 pcs.
185751	RJ45 module MU 1/8 Cat. 6, unshielded, colour code T568-B	white	10 pcs.

Please find an up-to-date matrix showing which patch panels, faceplates and outlets are suitable for the insertion of the respective Datwyler module on our website: www.cabling.datwyler.com.

Subject to technical modification.

Patch panel CUP 24/8, unshielded, Category 6 with 24 RJ45 jacks



Patch panel CUP 24/8 Cat. 6 unshielded

PRODUCT INFORMATION

APPLICATION Unshielded 19"/1U patch panel for the transmission of digital and analogue voice, video and data signals. Especially suited for all Class E applications in accordance with EN 50173-1 and ISO/IEC 11801. Applicable for Power over Ethernet (PoE) / PoE+ in accordance with IEEE 802.3at.

CONSTRUCTION

Housing:	Solid metal, black, similar to RAL 9005
Boards:	Three base boards, each with LSA plus terminal blocks and 8 RJ45 jacks (unshielded)
Strain relief:	with tie wrap
Dimensions:	19"/1U, W x D x H = 482 mm x 96 mm x 44 mm

A termination aid is available as an optional accessory. This consists of two angular sheets that can easily be fixed to the frame or cabinet and make the cable termination more comfortable.

CONNECTION SYSTEM

Cable:	LSA Plus punch down contacts
Socket:	Unshielded RJ45 connector (Cat.6, 250 MHz)

APPLICABLE STANDARDS

IEC 60603-7-4 (Cat. 6 unshielded, 250 MHz)
ISO/IEC 11801:2002/ Amd.2:2010
EN 50173-1:2011
TIA/EIA 568-B.2-10:2008

TERMINATION Wire termination in accordance with TIA-A and TIA-B, colour coded

GENERAL PROPERTIES  Category/Class Cat. 6 / Class E

Article No.	Description	Colour (similar to)	PU
418005	Patchpanel CUP 24/8 Cat. 6 unshielded	black, RAL 9005	1 pc.

Article No.	Accessories/Description	PU
1401624	Patch panel termination aid (1 set = 2 angular sheets)	1 set
185896	IDC termination tool 110 (recommended for outlets CSD, patch panels CSP and CUP, and for KS modules)	1 pc.
1401609	LSA Plus termination tool for LSA punch down contacts	1 pc.

Additional assembly tools / accessories can be found in the chapter System Accessories.

Phone panels CU 25/4 and CU 50/4, unshielded, Category 3

with 25 or 50 RJ45 jacks



Phone panel CU 25/4



Phone panel CU 50/4

PRODUCT INFORMATION

APPLICATION	Unshielded 19"/1U phone panels for the transmission of digital (ISDN) and analogue voice signals. Especially suitable for all Class C applications in accordance with EN 50173-1 and ISO/IEC 11801. The patch panels support cables up to 50 or 100 pairs (telephone cables). A maximum of four wires may be connected to one RJ45 socket.	
	A termination aid is available as an optional accessory. This consists of two angular sheets that can easily be fixed to the frame or cabinet and make the cable termination more comfortable. For more accessories see below.	
CONSTRUCTION	Housing:	Metal, grey, similar to RAL 7035
	Dimensions:	19"/1U, W x D x H = 482 mm x 129 mm x 44 mm
CONNECTION SYSTEM	Cable:	IDC termination
	Jack:	Unshielded RJ45 connector (EN 60603-7)
APPLICABLE STANDARDS	IEC 60603-7 (RJ45 basic standard, unshielded) ISO/IEC 11801:2002 / Amd.2:2010 EN 50173-1:2011 TIA/EIA 568-B.2-10:2008	
TERMINATION	2-pairs to PIN 3-6, 4-5	

Article No.	Description	Colour (similar to)	PU
418000	Phone panel CU 25/4 with 25x RJ45 jack, Cat. 3, metal chassis	grey, RAL 7035	1 pc.
418001	Phone panel CU 50/4 with 50x RJ45 jack, Cat. 3, metal chassis	grey, RAL 7035	1 pc.
418002	Phone panel CU 25/4 with 25x RJ45 jack, Cat. 3, metal chassis	black, RAL 9005	1 pc.
418003	Phone panel CU 50/4 with 50x RJ45 jack, Cat. 3, metal chassis	black, RAL 9005	1 pc.

Article No.	Accessories/Description	PU
1401624	Patch panel termination aid (1 set = 2 angular sheets)	1 set
1401609	LSA Plus termination tool for LSA punch down contacts	1 pc.
185896	IDC termination tool 110	1 pc.

COPPER FACEPLATES

UP-K Faceplate 1x, 2x, 3x

flush / duct mounted

for 1, 2 or 3 RJ45 modules with Keystone fitting, angled outlet

 GERMAN STANDARD



1-port faceplate, angled outlet



2-port faceplate, angled outlet



3-port faceplate, angled outlet

Similar figures

PRODUCT INFORMATION

DESCRIPTION

Faceplates applicable for the installation of 1, 2 or 3 modules with Keystone fitting. The modules are easily fitted into the faceplates. Integrated dust shutters. The central plate has a labelling field with transparent cover. Delivered without modules.

Suitable for the following Datwyler modules:

- PS-GG45 7_A 4P shielded
- RJ45 module KS-T Plus 1/8 Cat. 6_A shielded
- RJ45 module KS-TS 1/8 Cat. 6/E_A shielded
- RJ45 module KS-T 1/8 Cat. 6/E_A shielded
- RJ45 module KU-T 1/8 Cat. 6 / Cat. 5e unshielded

DIMENSIONS

Faceplates	German standard
Mounting plate	70 x 70 mm
Central plate	50 x 50 mm
Cover frame	80 x 80 mm

COLOUR

white, similar to RAL 9010

NOTE

3-port faceplate not compatible with switch range (designs) of other vendors.

Article No.		Description	Colour (similar to)	PU
185866		UP-K Faceplate for 1 module with Keystone snap-in fitting, angled	white, RAL 9010	1 pc.
185867		UP-K Faceplate for 2 modules with Keystone snap-in fitting, angled	white, RAL 9010	1 pc.
185869		UP-K Faceplate for 3 modules with Keystone snap-in fitting, angled	white, RAL 9010	1 pc.

UP Faceplate 2x
flush mounted

for 2 RJ45 modules with Keystone fitting, straight outlet

 GERMAN STANDARD

2-port faceplate with straight outlet

Blank cover for
unused openings

Similar figures

PRODUCT INFORMATION

DESCRIPTION

German flush-mount standard faceplate.
The snap-in modules are easily fitted into the faceplate.
The central plate has a labelling field with transparent cover.
Easy to assemble.
Delivered without Keystone modules.

Suitable for the following Datwyler modules:

- PS-GG45 7_A 4P shielded
- RJ45 module MS-K Plus 1/8 Cat. 6_A shielded
- RJ45 module KS-T Plus 1/8 Cat. 6_A shielded
- RJ45 module KS-TS 1/8 Cat. 6/E_A shielded
- RJ45 module KS-T 1/8 Cat. 6/E_A shielded
- RJ45 module KS-TA 1/8 Cat. 6/E_A shielded, 45 degree angled
- RJ45 module KU-T 1/8 Cat. 6 / Cat. 5e unshielded

DIMENSIONS

Faceplates	German standard
Central plate	50 x 50 mm
Cover frame	80 x 80 mm

COLOUR

white, similar to RAL 9010

Article No.	Description	Colour (similar to)	PU
185861 	UP Faceplate for 2 RJ45 Keystone modules, straight (delivery without modules)	white, RAL 9010	1 pc.

Article No.	Accessories/Description	Colour (similar to)	PU
418010	Blank cover for Keystone openings	white	10 pcs.

KS Anschlussdose gerade GS 0714/e

COPPER FACEPLATES

UP-K Faceplate 2x KS-T TAE

flush / duct mounted

for 2 RJ45 modules with Keystone fitting,
compatible with TAE 3-fold design



UP-K Faceplate 2x KS-T TAE

for 2 RJ45 modules with Keystone fitting, compatible with
all customary TAE 3-fold central plates design



Application examples

PRODUCT INFORMATION

DESCRIPTION

Modular faceplate for the installation of 2 shielded RJ45 Keystone modules.
Suitable for the flush and duct mounting and for floor box systems.
Mounting frame made of zinc die casting (offers possibility for connection to equipotential bonding).
The snap-in modules are easily fitted into the faceplate.
The mounting frames can be used together with all customary TAE 3-fold central plates
(for multiple designs).

Suitable for the following Datwyler modules:

- RJ45 module KS-T Plus 1/8 Cat. 6_A shielded
- RJ45 module KS-T 1/8 Cat. 6/E_A shielded
- RJ45 module KS-T 5 1/8 Cat. 5e shielded

DIMENSIONS

Mounting dimension: 60 mm

NOTE

Suitable for modules without dust cover only

SCOPE OF DELIVERY

Mounting frame
(delivery without central plate, cover frame, modules)

Article No.	Description	Material	PU
185871	UP-K UP-K Faceplate 2x KS-T TAE (delivery without central plate, cover frame, modules)	zinc die casting	1 pc.

UP-K Faceplates 2x, 3x duct mounted & floor boxes

for 2 or 3 RJ45 modules MS-K, angled

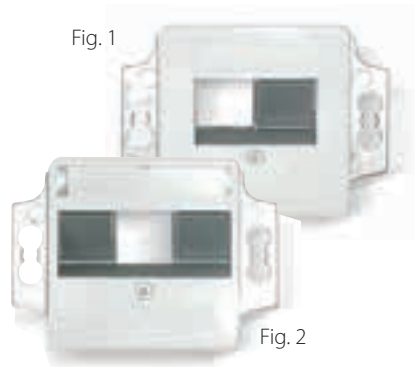

Faceplate RAL 1013
for 2 or 3 modules MS-K 1/8,
with central plate, without cover frame



Faceplate RAL 9010
for 2 or 3 modules MS-K 1/8,
with central plate, without cover frame



Fig. 5
cover frame 1-fold
for faceplates

PRODUCT INFORMATION

DESCRIPTION

Faceplates for the installation of 2 and 3 shielded RJ45 modules MS-K Plus 1/8 Cat.6_A or KS-TS 1/8 Cat.6/E_A.

Suitable for flush and duct mounting as well as for floor box systems.

In case of an installation in a flush-mount cup please use 2-port faceplates (Figure 1 and 3)!

Mounting frame made of zinc die casting (offers possibility for connection to equipotential bonding).

The snap-in modules are easily fitted into the faceplates.

Unused ports are covered with blank covers (metal) that can be removed.

The central plate has a labelling field with transparent cover.

The pure white versions (Figure 3 and 4) are supplied with pure white dust shutters to enable the replacement of the grey shutters at the installed modules.

The mounting frames of the 2-port faceplates (Figure 1 and 3) can be used together with all customary TAE central plates (for multiple designs).

Delivery without modules.

Suitable for the following Datwyler modules:

- RJ45 module MS-K Plus 1/8 Cat. 6_A shielded
- RJ45 module KS-TS 1/8 Cat. 6/E_A shielded

DIMENSIONS

Faceplates	
Mounting dimension	60 mm
Central plate	50 x 50 mm
Cover frame	80 x 80 mm

Article No.	Fig.	Description	Colour (similar to)
440012		UP-K Faceplate for 2x MS-K 1/8, angled (delivery without central plate, cover frame, modules)	
440013		UP-K Faceplate for 3x MS-K 1/8, angled (delivery without central plate, cover frame, modules)	
440015		UP-K Faceplate for 2x MS-K 1/8, angled, with central plate (without cover frame, modules)	oyster white, RAL 1013
440027		UP-K Faceplate for 2x MS-K 1/8, angled, with central plate and 2 dust shutters (without cover frame, modules)	pure white, RAL 9010
440028		UP-K Faceplate for 3x MS-K 1/8, angled, with central plate and 3 dust shutters (without cover frame, modules)	pure white, RAL 9010

Article No.	Fig.	Accessories/Description	Colour (similar to)
1400830	5	Cover frame 1-fold	pure white, RAL 9010
1401630	5	Cover frame 1-fold	oyster white, RAL 1013
1403924	-	Cover frame 2-fold	pure white RAL 9010
1403700	-	Cover frame 2-fold	oyster white RAL 1013

COPPER FACEPLATES

UP Faceplate 2x flush mounted

for 2 RJ45 modules, straight outlet

 GERMAN STANDARD

Similar figures



2-port faceplate with mounting frame and central plate, without cover frame



Cover frame 80 x 80 mm



Example: Faceplate complete with central plate, cover frame and one module

PRODUCT INFORMATION

DESCRIPTION

Ideally suitable for flush mounting with lack of space, for instance in a flush mount cup. Mounting frame consists of zinc die casting (offers possibility for connection to equipotential bonding). The snap-in modules are easily fitted into the faceplates. Unused ports are covered with blanking elements (metal) that can be removed. The central plate has a labelling field with transparent cover. The mounting frame can be used together with all customary TAE central plates (for multiple designs). Delivery without modules.

Suitable for the following Datwyler modules:

- RJ45 module MS-K Plus 1/8 Cat. 6_A shielded
- RJ45 module KS-T Plus 1/8 Cat. 6_A shielded
- RJ45 module KS-TS 1/8 Cat. 6/E_A shielded
- RJ45 module KS-T 1/8 Cat. 6/E_A shielded
- RJ45 module KU-T 1/8 Cat. 6 / Cat. 5e unshielded

DIMENSIONS

Faceplate	German standard
Central plate	50 x 50 mm
Cover frame	80 x 80 mm

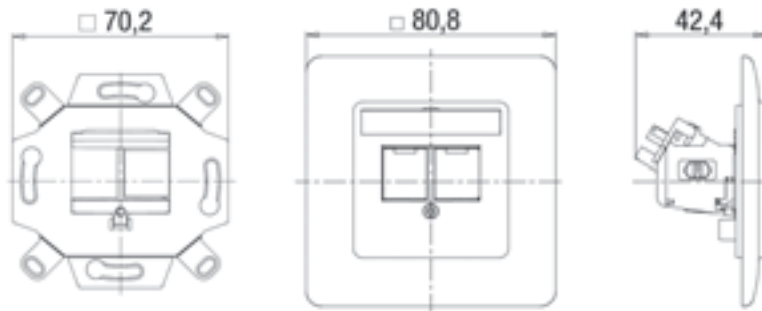

COLOUR

white, similar to RAL 9010

Article No.	Description	Colour (similar to)	PU
440020 	UP Faceplate for 2x RJ45 module, straight (delivery without modules)	white, RAL 9010	1 pc.
1400830	Cover frame 80 x 80 mm	white, RAL 9010	1 pc.

Article No.	Accessories/Description	Colour (similar to)	PU
417985	Dust shutters MS-K for reparation (1 set = 25 pcs.)	grey	1 set
417986	Dust shutters MS-K for reparation (1 set = 25 pcs.)	white, RAL 9010	1 set

MSK-Anschlussdose-0714/e

AP Surface Mount Boxes 2x, 4x, 6x surface mounted

for 2, 4 or 6 modules with Keystone fitting, straight



AP Surface Mount Box
for 2 or 4 Keystone modules
without dust shutters



Mounting plate



Blank cover for
unused ports



AP Surface Mount Box
for 2, 4 or 6 Keystone modules
with dust shutters

PRODUCT INFORMATION

DESCRIPTION

AP Surface Mount Box series made of plastic for fast surface mounted installations of up to 2, 4 or 6 modules with Keystone fitting.

All boxes have a labelling field.

The 2-port and 4-port versions are available with or without integrated dust shutters.

All shielded and unshielded Keystone modules tool-less as well as the PS-GG45 7_A module (with clip) are easily fitted into the boxes. When mounting the tool-less modules a cutout in the bottom of the box must be removed.

Delivery without modules.

Suitable for the following Datwyler modules:

- PS-GG45 7_A 4P shielded
- RJ45 module KS-T Plus 1/8 Cat. 6_A shielded
- RJ45 module KS-TS 1/8 Cat. 6/E_A shielded
- RJ45 module KS-T 1/8 Cat. 6/E_A shielded
- RJ45 module KU-T 1/8 Cat. 6 / Cat. 5e unshielded

DIMENSIONS

Surface Mount Box for 2 modules: 68 x 65 x 30 mm

Surface Mount Box for 4 modules: 118 x 85 x 30 mm

Surface Mount Box for 6 modules: 173 x 85 x 30 mm

COLOUR

white, similar to RAL 9010

ACCESSORIES

Mounting plate 65 x 42 mm, galvanised sheet,
with cable ties to fix the plate
and with adhesive strip to fix the AP box

Article No.	Description	Colour (similar to)	PU
418035	AP Surface Mount Box for 2x Keystone module (delivery without modules)	white, RAL 9010	1 pc.
418036	AP Surface Mount Box for 4x Keystone module (delivery without modules)	white, RAL 9010	1 pc.
418037	AP Surface Mount Box for 2x Keystone module with dust shutters (delivery without modules)	white, RAL 9010	1 pc.
418038	AP Surface Mount Box for 4x Keystone module with dust shutters (delivery without modules)	white, RAL 9010	1 pc.
418039	AP Surface Mount Box for 6x Keystone module with dust shutters (delivery without modules)	white, RAL 9010	1 pc.

Article No.	Accessories/Description	Colour (similar to)	PU
418010	Blank cover for Keystone openings (1 set = 10 pcs.)	white	1 set
417486	Mounting plate for AP Surface mount boxes with adhesive strip and cable ties		1 pc.

COPPER FACEPLATES

Faceplates French Standard

for 1 or 2 Keystone modules

straight or angled



Cover frame French Standard
80 x 80 mm

Bezel 1 port
45 x 45 mm

Bezel 1 port slim
45 x 22.5 mm

Bezel 2 ports angled
45 x 45 mm

PRODUCT INFORMATION

DESCRIPTION

Faceplates for the installation in Module 45 Systems, e.g. for standard Legrand inserts (bezels) with straight outlet.
Compatible with all Datwyler Keystone modules.
All Datwyler Keystone modules (FTP, UTP) are easily fitted into the inserts.
Made of flame retardant material.
With integrated dust shutters and labelling fields.
Delivery without modules.

Suitable for the following Datwyler modules:

- PS-GG45 7_A 4P shielded
- RJ45 module KS-T Plus 1/8 Cat. 6_A shielded
- RJ45 module MS-C6_A 1/8 Cat. 6_A 180°-K shielded
- RJ45 module KS-TS 1/8 Cat. 6/E_A shielded

DIMENSIONS

1 Port	45 x 45 mm	(French Standard)
1 Port (slim)	45 x 22.5 mm	(French Standard)
2 Ports	45 x 45 mm	(French Standard)

COLOUR

bright white

APPLICATIONS



Article No.	Description	Colour (similar to)	PU
418030	Keystone Bezel 1 Port 45 x 45 mm straight	bright white	1 pc.
418031	Keystone Bezel 1 Port slim 45 x 22.5 mm straight	bright white	1 pc.
418032	Keystone Bezel 2 Ports 45 x 45 mm straight	bright white	1 pc.
418033	Keystone Bezel 2 Ports, 45 x 45 mm angled	bright white	1 pc.
418034	Faceplate French Standard for Bezel 45 x 45 mm	bright white	1 pc.

KS Bezel FS 0714/e

**UP-K Faceplates 1x, 2x
flush / duct mounted**

for 1 or 2 RJ45 modules with Keystone fitting, angled outlet



1-port faceplate, angled outlet



2-port faceplate, angled outlet

Similar figures

PRODUCT INFORMATION

DESCRIPTION

Applicable for the installation of 1 respectively 2 Keystone modules, shielded or unshielded. The Keystone modules are easily fitted into the faceplates. Integrated dust shutters which also serve as covers for unused ports. The central plate has a labelling field with transparent cover. Delivered without Keystone modules.

Suitable for the following Datwyler Modules:

- PS-GG45 7_A 4P shielded
- RJ45 module KS-T Plus 1/8 Cat. 6_A shielded
- RJ45 module KS-TS 1/8 Cat. 6/E_A shielded
- RJ45 module KS-T 1/8 Cat. 6/E_A shielded
- RJ45 module KU-T 1/8 Cat. 6 / Cat. 5e unshielded

DIMENSIONS

Faceplates	British standard
Cover frame	86 x 86 mm

COLOUR

white, similar to RAL 9010

Article No.	Description	Colour (similar to)	PU
185862	UP-K Faceplate for 1x RJ45 Keystone module, angled (delivery without module)	white, RAL 9010	1 pc.
185863	UP-K Faceplate for 2x RJ45 Keystone module, angled (delivery without modules)	white, RAL 9010	1 pc.

COPPER FACEPLATES

UP Faceplates 1x, 2x

flush mounted

for 1 or 2 RJ45 modules with Keystone fitting, straight outlet

 BRITISH STANDARD

Similar figures



1-port faceplate with straight outlet



2-port faceplate with straight outlet

PRODUCT INFORMATION

DESCRIPTION

Applicable for the installation of 1 respectively 2 Keystone modules, shielded or unshielded. The Keystone modules are easily fitted into the faceplates. Fitted with integrated dust shutters which also serve as covers for unused ports. Supplied with labelling strips. Delivered without Keystone modules.

Suitable for the following Datwyler modules:



- PS-GG45 7_A 4P shielded
- RJ45 module KS-T Plus 1/8 Cat. 6_A shielded
- RJ45 module KS-TS 1/8 Cat. 6/E_A shielded
- RJ45 module KS-T 1/8 Cat. 6/E_A shielded
- RJ45 module KU-T 1/8 Cat. 6 / Cat. 5e unshielded

DIMENSIONS

Faceplates	British standard
Central plate	50 x 50 mm (2 x 25 x 50 mm)
Cover frame	86 x 86 mm

COLOUR

white, similar to RAL 9010

Article No.		Description	Colour (similar to)	PU
185864		UP Faceplate for 1x RJ45 Keystone module, straight (delivery without module)	white, RAL 9010	1 pc.
185865		UP Faceplate for 2x RJ45 Keystone module, straight (delivery without modules)	white, RAL 9010	1 pc.

Copper

Fibre Optics

Cabinets & Racks

Data Centre

Wireless

Multimedia

General Information

KS Anschlusdose fach BS 07 14/e

UP-K Faceplates 2x, 3x duct mounted & floor boxes

for 2 or 3 RJ45 modules 180° MS 1/8



Fig. 1: 2-port faceplate
for 2 modules (without cover frame)



Fig. 2: 3-port faceplate
for 3 modules (without cover frame)



Fig. 3: Cover frame
80 x 80 mm

PRODUCT INFORMATION

DESCRIPTION

German standard faceplate 2x and 3x, angeled, for the installation of 2 or 3 RJ45 modules MS, MU or MS-C6_A (rotated 180°).

Duct mount installation or installation in floor boxes.

Due to the modular design these faceplates can be used in combination with many faceplate design families (for multiple designs).

The snap-in modules can be easily fitted into the faceplates.

Integrated dust shutters which also serve as covers for unused ports.

Delivery without modules.

Suitable for the following Datwyler modules:

- RJ45 module MS 1/8 Cat. 6/E_A shielded
- RJ45 module MU 1/8 Cat. 6 unshielded
- RJ45 module MS-C6_A 1/8 Cat. 6_A shielded

DIMENSIONS

Faceplates	
Mounting frame	70 x 70 mm
Central plate	50 x 50 mm
Cover frame	80 x 80 mm

Article No.	Fig.	Description	Colour (similar to)	PU
1411748		1 UP-K Duct mount faceplate for 2x module MS/MU 1/8 (delivery without cover frame, modules)	pure white, RAL 9010	1 pc.
1411747		- UP-K Duct mount faceplate for 2x module MS/MU 1/8 (delivery without cover frame, modules)	oyster white, RAL 1013	1 pc.
1411750		2 UP-K Duct mount faceplate for 3x module MS/MU 1/8 (delivery without cover frame, modules)	pure white, RAL 9010	1 pc.
1411749		- UP-K Duct mount faceplate for 3x module MS/MU 1/8 (delivery without cover frame, modules)	oyster white, RAL 1013	1 pc.

Article No.	Fig.	Accessories/Description	Colour (similar to)	PU
185700	-	RJ45 module MS 1/8 Cat. 6/E _A shielded, T568-A	metal	10 pcs.
1414227	-	RJ45 module MS 1/8 Cat. 6/E _A shielded, T568-B	metal	10 pcs.
309250	-	RJ45 module MS-C6 _A 1/8 Cat. 6 _A shielded	metal	10 pcs.
1400830		3 Cover frame 1-port 80 x 80 mm	pure white, RAL 9010	1 pc.
1401630		- Cover frame 1-port 80 x 80 mm	oyster white, RAL 1013	1 pc.
1403924		- Cover frame 2-port 150 x 80 mm	pure white, RAL 9010	1 pc.
1403700		- Cover frame 2-port 150 x 80 mm	oyster white, RAL 1013	1 pc.

COPPER FACEPLATES

UP / UP-K Faceplates 2x, 3x flush / duct mounted

for 2 or 3 RJ45 modules MS 1/8 or MS-C6_A
design: compatible with Edizio

 SWISS STANDARD



Fig. 1: 2-port faceplate for 2 modules MS (with add-on frame 60 x 60 mm without cover frame)



Fig. 2: 3-port faceplate for 3 modules MS (with add-on frame 60 x 60 mm without cover frame)



Fig. 3: Cover frame Edizio due 88 x 88 mm



Fig. 4: Dust covers MS

PRODUCT INFORMATION

DESCRIPTION

Swiss standard 2-port and 3-port faceplates for the installation of 2 or 3 RJ45 modules MS. Compatible with Edizio. For flush and duct mounted installation. The snap-in modules can be easily fitted into the faceplates. Integrated dust shutters which also serve as covers for unused ports. Delivery without modules.

Suitable for the following Datwyler modules:

- RJ45 module MS-C6_A 1/8 Cat. 6_A shielded
- RJ45 module MS 1/8 Cat. 6/E_A shielded
- RJ45 module MU 1/8 Cat. 6 unshielded



DIMENSIONS

UP / UP-K Faceplates (Fig. 1 and 2):
Mounting frame 70 x 70 mm
Front plate (central plate with distance frame) 60 x 60 mm



ACCESSORIES

Cover frame Edizio due (Fig. 3):
Dimensions 88 x 88 mm

Article No.	Fig.	Description	Colour (similar to)	PU
185688	 1	UP-K Duct mounted faceplate, compatible with Edizio for 2x module MS/MU 1/8 (without cover frame, modules)	white, RAL 9016	1 pc.
185691	 1	UP-K Duct mounted faceplate, compatible with Edizio for 2x module MS/MU 1/8 (without cover frame, modules)	white, RAL 9016	1 pc.

Article No.	Fig.	Accessories/Description	Colour (similar to)	PU
185732	3	Cover frame Edizio due	white, RAL 9016	
185715	 -	Labeling sheets A4 for UP/AP faceplates	white	
190937	4	Dust cover MS	yellow	10 pcs.
190938	4	Dust cover MS	blue	10 pcs.
190939	4	Dust cover MS	green	10 pcs.
190940	4	Dust cover MS	red	10 pcs.

UP / UP-K Faceplates MPS 2x (round) flush / duct mounted

for 2 modules MS 1/8 or PS-TERA, round, design: Feller



UP Faceplate MPS 2x
(flush mounted)



UP-K Faceplate MPS 2x
(duct mounted, without
cover frame)



Blank cover MS

PRODUCT INFORMATION

DESCRIPTION

Modular round faceplates for the installation of 2 PS-TERA, MS-C6_A 1/8 or MS/MU 1/8 modules, comprising central plate, mounting frame and (model UP) cover frame. Delivery without modules.

APPLICATION

Design: Feller standard

Flush mounted: with cover frame 86 x 86 mm

Duct mounted: with mounting frame 70 x 70 mm (without cover frame)

Suitable for the following Datwyler modules:

- RJ45 module MS-C6_A 1/8 Cat. 6_A shielded
- RJ45 module MS 1/8 Cat. 6/E_A shielded
- RJ45 module MU 1/8 Cat. 6 unshielded
- PS-TERA 4P Cat. 7_A shielded
- Blank cover MS for unused openings

Article No.		Description	Colour (similar to)	PU
185764		UP Flush mounted faceplate, Feller, for 2x PS 1/8 Cat. 7 _A / 2x MS 1/8 Cat. 6, with cover frame	white	1 pc.
185765		UP-K Duct mounted faceplate, Feller, for 2x PS 1/8 Cat. 7 _A / 2x MS 1/8 Cat. 6 (without cover frame)	white	1 pc.

Article No.		Accessories/Description	Colour (similar to)	PU
190977		Blank cover for unused MS openings	light grey	10 pcs.
309213		Blank cover for unused MS openings	white	10 pcs.

COPPER FACEPLATES

AP / UP / UP-K Faceplates 2x (Edizio due)

surface / flush / duct mounted

for 2 modules MS 1/8, MS-C6_A or PS-TERA, angled, design: Feller

 SWISS STANDARD



UP-K faceplate (duct mounted installation without cover frame, with mounting frame 70 x 70 mm)



UP faceplate (flush mounted installation with cover frame 88 x 88 mm)



AP faceplate (surface mounted installation with housing 88 x 88 x 67 mm)



Blank cover MS

PRODUCT INFORMATION

DESCRIPTION



Modular faceplate system Edizio Feller with angled outlets for the installation of up to 2 modules MS 1/8, MS-C6_A 1/8 or PS-TERA, comprising mounting frame, central plate Edizio with openings, cover frame resp. surface mounted housing. Delivery without modules.

APPLICATION

Design Edizio without 88 x 88 mm cover frame for flush-mounted installation in Thealit ducts with blind technology (UP-K).
Design Edizio with 88 x 88 mm cover frame for flush mounted installation (UP).
Design Edizio central plate with openings in 88 x 88 x 67 mm housing on solid mounting frame for wall mounted (AP) installation.

Suitable for the following Datwyler modules:

- RJ45 module MS-C6_A 1/8 Cat. 6_A shielded
- RJ45 module MS 1/8 Cat. 6/E_A shielded
- RJ45 module MU 1/8 Cat. 6 unshielded
- PS-TERA 4P Cat. 7_A shielded
- Blank cover MS for unused openings

Article No.		Description	Colour (similar to)	PU
185761		UP-K Faceplate Edizio due for PS/MS modules, angled (delivery without cover frame, modules)	white, RAL 9010	1 pc.
185763		UP Faceplate Edizio due for PS/MS modules, angled, with cover frame (delivery without modules)	white, RAL 9010	1 pc.
185762		AP Wall mounted outlet Edizio 56 mm for PS/MS modules (delivery without modules)	white, RAL 9010	1 pc.

Article No.	Accessories/Description	Colour (similar to)	PU
190977	Blank cover for unused MS openings	light grey	10 pcs.
309213	Blank cover for unused MS-openings	white	10 pcs.

AP / UP / UP-K Faceplates 2x
surface / flush / duct mounted

for 2 modules KS or PS-GG45, angled, design: Kallysto



Fig. 1: Duct mounted (UP-K) without cover frame, with mounting frame 70 x 70 mm



Fig. 1: Flush mounted (UP) with cover frame, with mounting frame 88 x 88 mm



Fig. 3: Surface mounted (AP) with surface mount box, with mounting frame 88 x 88 x 67 mm



Fig. 4: Duct mounted (UP-K) without cover frame, with mounting frame 70 x 70 mm



Fig. 5: Flush mounted (UP) with cover frame, with mounting frame 88 x 88 mm



Fig. 6: Surface mounted (AP) with surface mount box, with mounting frame 88 x 88 x 67 mm

Solutions with additional distance frame 60 x 60 x 15 mm

PRODUCT INFORMATION

DESCRIPTION

Modular faceplate system Kallysto Hager with angled outlets, optimized by Datwyler for the installation of 2 modules.
 Available with optional distance frame - for the professional, fast installation of bigger modules.
 All faceplates offer the possibility of colour coding.
 Delivery with one blank cover - without modules.

APPLICATION

Suitable for the following Datwyler modules:

- PS-GG45 7_A 4P shielded
- RJ45 module KS-T Plus 1/8 Cat. 6_A shielded
- RJ45 module MS-C6_A 1/8 Cat. 6_A 180°-K shielded
- RJ45 module KS-TS 1/8 Cat. 6/E_A shielded
- RJ45 module KS-T 1/8 Cat. 6/E_A shielded
- RJ45 module KU-T 1/8 Cat. 6 / Cat. 5e unshielded

Article No.	Fig.	Description	Colour (similar to)
309199		1 UP-K Faceplate Kallysto for 2x KS/GG45, angled (delivery without distance frame, cover frame)	white, RAL 9016
309200		2 UP Faceplate Kallysto for 2x KS/GG45, angled, with cover frame (delivery without distance frame)	white, RAL 9016
309201		3 AP Faceplate Kallysto for 2x KS/GG45, angled (delivery without distance frame)	white, RAL 9016
309196		4 UP-K Faceplate Kallysto for 2x KS/GG45, angled, with distance frame (delivery without cover frame)	white, RAL 9016
309197		5 UP Faceplate Kallysto for 2x KS/GG45, angled, with distance frame, with cover frame	white, RAL 9016
309198		6 AP Faceplate Kallysto for 2x KS/GG45, angled, with distance frame	white, RAL 9016

Article No.	Accessories/Description	Colour	PU
309203	Coding frame Kallysto KS	white	10 pcs.
309204	Coding frame Kallysto KS	beige	10 pcs.
309205	Coding frame Kallysto KS	brown	10 pcs.
309206	Coding frame Kallysto KS	red	10 pcs.
309207	Coding frame Kallysto KS	yellow	10 pcs.
309208	Coding frame Kallysto KS	green	10 pcs.
309209	Coding frame Kallysto KS	blue	10 pcs.

COPPER FACEPLATES

**AP / UP / UP-K Faceplates 2x
surface / flush / duct mounted**

for 2 modules MS 1/8 or MU 1/8, angled, design: Kallysto

 SWISS STANDARD



Fig. 1: Duct mounted (UP-K)
without cover frame
with mounting frame 70 x 70 mm



Fig. 1: Flush mounted (UP)
with cover frame
with mounting frame 88 x 88 mm



Fig. 3: Surface mounted (AP)
with surface mount box
88 x 88 x 67 mm



Solutions with additional distance frame 60 x 60 x 15 mm
Fig. 4: Duct mounted (UP-K)
without cover frame
with mounting frame 70 x 70 mm



Fig. 5: Flush mounted (UP)
with cover frame
with mounting frame 88 x 88 mm



Fig. 6: Surface mounted (AP)
with surface mount box
88 x 88 x 67 mm

PRODUCT INFORMATION







DESCRIPTION

Modular faceplate system Kallysto Hager with angled outlets, optimized by Datwyler for the installation of 2 modules.
Available with optional distance frame - for the professional, fast installation of bigger modules.
Delivery with one blank cover - without modules.

APPLICATION

Suitable for the following Datwyler modules:

- RJ45 module MS-C6_A 1/8 Cat. 6_A shielded
- RJ45 module MS 1/8 Cat. 6/E_A shielded
- RJ45 module MU 1/8 Cat. 6 unshielded

Article No.	Fig.	Description	Colour (similar to)
309193	 1	UP-K Faceplate Kallysto for 2x MS/MU 1/8, angled (delivery without distance frame, cover frame)	white, RAL 9016
309194	 2	UP Faceplate Kallysto for 2x MS/MU 1/8, angled, with cover frame (delivery without distance frame)	white, RAL 9016
309195	 3	AP Faceplate Kallysto for 2x MS/MU 1/8, angled (without distance frame)	white, RAL 9016
309190	 4	UP-K Faceplate Kallysto for 2x MS/MU 1/8, angled, with distance frame (delivery without cover frame)	white, RAL 9016
309191	 5	UP Faceplate Kallysto for 2x MS/MU 1/8, angled, with distance frame, with cover frame	white, RAL 9016
309192	 6	AP Faceplate Kallysto for 2x MS/MU 1/8, angled, with distance frame	white, RAL 9016

Article No.	Accessories/Description	Colour	PU
309202	Blank cover for unused Kallysto faceplate openings	white	10 pcs.
309210	Distance frame for Kallysto faceplate 60 x 60 x 15 mm	white	1 pc.

AP / UP / UP-K Faceplates 2x (Edizio flat)

surface / flush / duct mounted

for 2 modules, flat outlet, design: Feller

 SWISS STANDARD

Flush mounted flat outlet
Feller Edizio due (UP)



Surface mounted flat outlet
Feller Edizio due (AP)



Side view of
Feller Edizio flat outlet

PRODUCT INFORMATION

DESCRIPTION

Flat outlet covers Feller Edizio due for 2 modules MS 1/8, PS-TERA or PS-GG45. The flat outlet covers enable easy module connections and allow for good bending radii. They are original Feller products and suit into the Feller modular system. Delivery without modules.

a) suitable for the following Datwyler modules:







- RJ45 module MS-C6_A 1/8 Cat. 6_A shielded
- RJ45 module MS 1/8 Cat. 6/E_A shielded
- PS-TERA 4P Cat. 7_A shielded
- Blank cover MS for unused openings

b) suitable for the following Datwyler module:

- PS-GG45 7_A 4P shielded

DIMENSIONS

Flush / duct mounted	
Mounting frame	70 x 70 mm
flat outlet cover cut-out	60 x 60 mm
flat outlet cover depth	37 mm
Cover frame	88 x 88 mm
Surface mounted	
Mounting frame	70 x 70 mm
long cover cut-out	60 x 60 mm
flat outlet cover (W x H x D)	74 x 74 x 54 / 84 mm

Article No		Suitable for	Description	Colour (similar to)
185747		a UP	Flush mounted flat outlet cover Feller Edizio due for 2 modules PS-TERA / MS, with cover frame (delivery without modules)	white, RAL 9016
185749		a UP-K	Duct mounted flat outlet cover Feller Edizio due for 2 modules PS-TERA / MS, (delivery without cover frame, without modules)	white, RAL 9016
185748		a AP	Surface mounted flat outlet cover Feller Edizio due for 2 modules PS-TERA / MS (delivery without modules)	white, RAL 9016
190958		b UP	Flush mounted flat outlet cover Feller Edizio due for 2 modules PS-GG45, with cover frame (without modules)	white, RAL 9016
190965		b AP	Surface mounted flat outlet cover Feller Edizio due for 2 modules PS-GG45 (delivery without modules)	white, RAL 9016

COPPER FACEPLATES

AP Faceplate 2x

surface mounted

for 2 RJ45 modules 180° MS 1/8 or MS-C6_A, angled

 SWISS STANDARD



AP Faceplate 2x for 2 modules
with surface mount box 80 x 80 x 40 mm

PRODUCT INFORMATION

DESCRIPTION

Modular 2-port surface mounted AP faceplate for the installation of 2 RJ45 modules MS or MS-C6_A, 180° rotated.

The snap-in modules are easily fitted into the faceplate.
Integrated dust shutters also serve as covers for unused ports.
Delivery without modules.

Suitable for the following Datwyler modules:

- RJ45 module MS-C6_A 1/8 Cat. 6_A shielded
- RJ45 module MS 1/8 Cat. 6/E_A shielded
- RJ45 module MU 1/8 Cat. 6 unshielded

DIMENSIONS

W x H x D 85 x 85 x 40 mm

COLOUR

pure white, similar to RAL 9016

Article No.	Description	Colour (similar to)
185694 	Faceplate for 2x module MS/MU 1/8 (delivery without modules, cover frame)	pure white, RAL 9016

Article No.	Accessories/Description	Colour
185700	RJ45 module MS 1/8 Cat. 6/E _A shielded, T568-A	metallic
1414227	RJ45 module MS 1/8 Cat. 6/E _A shielded, T568-B	metallic
309250	RJ45 module MS-C6 _A 1/8 Cat. 6 _A (IEC)	metallic

FLF Faceplates 2x, 3x

doorframe / profile / duct mounted
for 2 and 3 modules

 SWISS STANDARD

Fig. 1: FLF Faceplate 2x
for 2 modules MS/MU



Fig. 2: FLF Faceplate 2x
for 2 modules PS-GG45



Fig. 3: FLF Faceplate 3x
for 3 modules MS/MU, white or black

PRODUCT INFORMATION

DESCRIPTION

FLF faceplate 2x

for the installation of up to 2 modules MS 1/8, MU 1/8, MS-C_{6A} 1/8, PS-TERA or PS-GG45.
Easy screw-less mounting in doorframes, profiles, ducts, control panels etc. due to a catch spring.
Equipped with dust shutters that also serve as covers for unused ports.
Delivery without modules.

Variant with metal clip for a more stable mounting (available for modules MS 1/8 and MU 1/8 only).

Suitable for the following Datwyler modules:

- RJ45 module MS-C_{6A} 1/8 Cat. 6_A shielded
- RJ45 module MS 1/8 Cat. 6/E_A shielded
- RJ45 module MU 1/8 Cat. 6 unshielded
- PS-TERA 4P Cat. 7_A shielded
- PS-GG45 7_A 4P shielded
- Blank cover MS for unused ports

DIMENSIONS

W x H x D 37.5 x 62.5 x 40 mm







DESCRIPTION

FLF faceplate 3x

for the installation of up to 3 modules MS 1/8, MU 1/8 or MS-C_{6A} 1/8.
Easy screw-less mounting in doorframes, profiles, ducts, control panels etc. due to a catch spring.
Equipped with dust shutters that also serve as covers for unused ports.
Delivery without modules.

Suitable for the following Datwyler modules:

- RJ45 module MS-C_{6A} 1/8 Cat. 6_A shielded
- RJ45 module MS 1/8 Cat. 6/E_A shielded
- RJ45 module MU 1/8 Cat. 6 unshielded

Article No.	Fig.	Description	Colour (similar to)
309211	 2	FLF Faceplate for 2x module PS-GG45 (delivery without modules)	white, RAL 9016
309212	 1	FLF Faceplate for 2x module MS/MU (delivery without modules)	white, RAL 9016
190916	 –	FLF Faceplate for 2x module MS/MU or PS-TERA (delivery without modules)	white, RAL 9010
190905	 –	FLF Faceplate for 2x module MS/MU with metal clip (delivery without modules)	white, RAL 9010
185693	 3	FLF Faceplate for 3x module MS/MU (delivery without modules)	white, RAL 9010
190915	 3	FLF Faceplate for 3x module MS/MU 1/8 (delivery without modules)	black, RAL 9005

COPPER FACEPLATES

UP-K Faceplate PS-TERA 2x duct mounted

for 2 modules PS-TERA 4P, angled

 GERMAN STANDARD



Fig. 1: Faceplate
for 2 modules PS-TERA 4P, angled



Fig. 2: Example for faceplate
with 2 modules PS-TERA 4P and cover frame

PRODUCT INFORMATION

DESCRIPTION

Modular faceplate PS-TERA 2x for duct mounting (UP-K).
For the installation of 2 modules PS-TERA 4P with angled outlet.
The modules can be easily fitted into the faceplate.
Labelling field with transparent cover.
Delivery without modules.

APPLICATION

The modules PS-TERA 4P enable the installation of multimedia cabling systems up to Class F_A.
At each PS-TERA 4P module the connected 4 pairs can be patched individually, e.g. for transmission of TV, video, data or telephone. Thus, the single pairs in one data cable can be simultaneously used for different applications.

NOTE

The PS-TERA 4P modules can not only be used in this faceplate but also in all Datwyler faceplates, patch panels and floor box solutions with MPS openings.

Article No.	Fig.	Description	Colour (similar to)	PU
1408505	 1	UP-K Faceplate for 2x module PS-TERA 4P (delivery without cover frame, modules)	white, RAL 9010	1 pc.
1400830	 (2)	Cover frame 80 x 80 mm	white, RAL 9010	1 pc.

Article No.	Accessories/Description	Colour	PU
1408502	Module PS-TERA 4P Cat. 7 ₄ /F ₈ shielded	black	1 pc.

Patch panel KS 24x

for 24 modules with Keystone fitting
shielded



Blank covers,
black and white

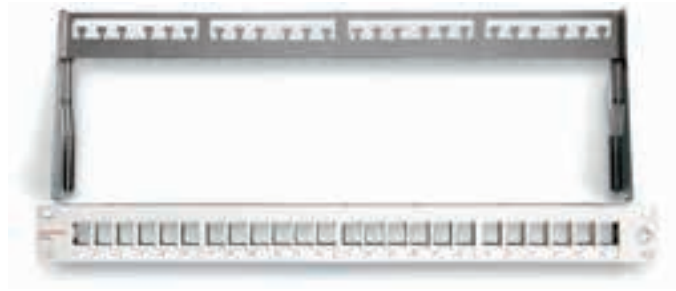

Patch panel KS 24x, shielded

PRODUCT INFORMATION

APPLICATION

Shielded 19"/1U patch panel for up to 24 modules with Keystone fitting. Snap-in modules can be easily fitted into the patch panel. Unused ports can be covered with blank covers.

For the modules PS-GG45 7_A Datwyler recommends the patch panel MGK 24x.

DESCRIPTION

Front panel made of flame retardant compound, UL94V-0 rated, in combination with stainless steel and a cable strain relief.

Front in grey, similar to RAL 7035, or in black, similar to RAL 9005.

Strain relief with tie wrap.

Delivery without modules.

Suitable for the following Datwyler modules:

- RJ45 module KS-T Plus 1/8 Cat. 6_A shielded
- RJ45 module KS-TS 1/8 Cat. 6/E_A shielded
- RJ45 module KS-T 1/8 Cat. 6/E_A shielded
- RJ45 module KU-T 1/8 Cat. 6 / Cat. 5e unshielded
- RJ45 module MS-C6_A 1/8 Cat. 6_A 180°-K shielded

DIMENSIONS

Width	482 mm (19")
Depth	160 mm (including cable strain relief)
Height	44 mm (1U)

Article No.	Description	Colour (similar to)	PU
418019	Patch panel KS 24x, 19"/1U, for 24x RJ45 Keystone module, FTP (delivery without modules)	black, RAL 9005	1 pc.
418020	Patch panel KS 24x, 19"/1U, for 24x RJ45 Keystone module, FTP (delivery without modules)	grey, RAL 7035	1 pc.

Article No.	Accessories/Description	Colour (similar to)	PU
418010	Blank cover for Keystone openings	white	10 pcs.
418011	Blank cover for Keystone openings	black	10 pcs.

COPPER PATCH PANEL

Patch panel KS 24x-a, angled

for 24 modules with Keystone fitting

shielded



Shielded patch panel KS 24x-a, angled



Top cover for patch panel KS 24x-a, angled



Blank cover, black

PRODUCT INFORMATION

APPLICATION

Shielded 19"/1U angled patch panel for up to 24 modules with Keystone fitting. Snap-in modules can be easily fitted into the patch panel. Unused ports can be closed with blank covers. Due to the angled front it is possible to patch without any cable management panel.

DESCRIPTION

Front panel made of flame retardant compound, UL94V-0 rated, in combination with stainless steel and a cable strain relief. Front colour black, similar to RAL 9005. Strain relief with tie wrap. Delivery without modules.

Suitable for the following Datwyler modules:

- RJ45 module KS-T Plus 1/8 Cat. 6_A shielded
- RJ45 module KS-TS 1/8 Cat. 6/E_A shielded
- RJ45 module KS-T 1/8 Cat. 6/E_A shielded
- RJ45 module KU-T 1/8 Cat. 6 / Cat. 5e unshielded
- RJ45 module MS-C6_A 1/8 Cat. 6_A 180°-K shielded

DIMENSIONS

Width 482 mm (19")
 Depth 250 mm (including cable strain relief)
 Height 44 mm (1U)

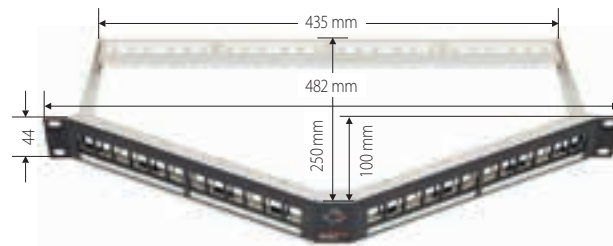

ACCESSORIES

Top cover for patch panel KS 24x-a, angled, to separate the warm and cold airflow, galvanized steel

Article No.	Description	Colour (similar to)	PU
4000099	Patch panel KS 24x-a, angled, 19"/1U, for 24x RJ45 Keystone module, FTP (without modules)	black, RAL 9005	1 pc.

Article No.	Accessories/Description	Colour (similar to)	PU
418011	Blank cover for Keystone openings	black	10 pcs.
400098	Top cover for patch panel KS 24x-a, angled, to separate the warm and cold airflow	galvanized steel	1 pc.

KS 24x-a 0714/e

Patch panel KS 24x-s for 24 RJ45 modules KS-TA 1/8, 45 degree angled shielded



Patch panel KS 24x-s, shielded

RJ45 module KS-TA 1/8 Cat. 6/E_A,
shielded, 45 degree angled

PRODUCT INFORMATION

APPLICATION

Shielded 19"/1U patch panel for up to 24 angled RJ45 modules KS-TA 1/8 (Article No. 418068).
Two rows of six ports on each side:
for 12 modules pointing to the left side and 12 modules pointing to the right side.
Snap-in modules can be easily fitted into the patch panel.
Due to their angled design it is possible to patch without any cable management panel.

DESCRIPTION

Front panel made of flame retardant compound, UL94V-0 rated,
in combination with stainless steel and a cable strain relief.
Front colour black, similar to RAL 9005.
Strain relief with tie wrap.
Delivery without modules.

Suitable for the Datwyler module:

- RJ45 module KS-TA 1/8 Cat. 6/E_A (Article No. 418068)

DIMENSIONS

Width: 482 mm (19")
Depth: 120 mm (including cable strain relief)
Height: 44 mm (1U)

Article No.	Description	Colour (similar to)	PU
418023	Patch panel KS 24x-s, 19"/1U, shielded	black, RAL 9005	1 pc.
418068	RJ45 module KS-TA 1/8 Cat. 6/E _A , shielded, 45 degree angled	metal	10 pcs.

COPPER PATCH PANEL

Patch panels MGK 24x and MGK 12x for 24 and 12 PS-GG45 7_A or modules with Keystone fitting shielded



Patch panel MGK 24x, shielded



Blank covers,
black and white

Patch panel MGK 12x, shielded

PRODUCT INFORMATION

APPLICATION

Shielded 19"/1U and 10"/1U patch panels for up to 24 and up to 12 PS-GG45 7_A modules with Keystone clip and modules with Keystone fitting. Snap-in modules can be easily fitted into the patch panels. Unused ports can be covered with blank covers.

DESCRIPTION

Front panel stainless steel or (MGK 24x only) light grey, similar to RAL 7035. Strain relief with tie wrap. Delivery without modules.

Suitable for the following Datwyler modules:

- PS-GG45 7_A 4P shielded
- RJ45 module KS-T Plus 1/8 Cat. 6_A shielded
- RJ45 module KS-TS 1/8 Cat. 6/E_A shielded
- RJ45 module KS-T 1/8 Cat. 6/E_A shielded
- RJ45 module MS-C6_A 1/8 Cat. 6_A 180°-K shielded

DIMENSIONS

MGK 24x:
Width 482 mm (19")
Depth 160 mm (including cable strain relief)
Height 44 mm (1U)

Article No.	Description	Colour (similar to)	PU
440042	Patch panel MGK 24x, 19"/1U for 24x module with Keystone fitting	stainless steel	1 pc.
440043	Patch panel MGK 24x, 19"/1U for 24x module with Keystone fitting	grey, RAL 7035	1 pc.
440044	Patch panel MGK 12x, 10"/1U for 12x module with Keystone fitting	stainless steel	1 pc.

Article No.	Accessories/Description	Colour (similar to)	PU
418010	Blank cover for Keystone openings	white	10 pcs.
418011	Blank cover for Keystone openings	black	10 pcs.

Patch panels MGK 48x for 48 PS-GG45 7_A and modules with Keystone fitting shielded



Patch panel MGK 48x, shielded

Blank covers,
black and white

PRODUCT INFORMATION

APPLICATION

Shielded 19"/1.5U patch panel for up to 48 PS-GG45 7_A modules with Keystone clip and modules with Keystone fitting. Comes with installation aid for easy insertion of snap-in modules. Unused ports can be covered with blank covers.

DESCRIPTION

Front light grey, similar to RAL 7035.
Strain relief with tie wrap.
Delivery without modules.

Suitable for the following Datwyler modules:

- PS-GG45 7_A 4P shielded
- RJ45 module KS-T Plus 1/8 Cat. 6_A shielded
- RJ45 module KS-TS 1/8 Cat. 6/E_A shielded
- RJ45 module KS-T 1/8 Cat. 6/E_A shielded
- RJ45 module MS-C6_A 1/8 Cat. 6_A 180°-K shielded

DIMENSIONS

Width	482 mm (19")
Depth	145 mm (including cable strain relief)
Height	66 mm (1U)

Article No.	Description	Colour (similar to)	PU
440051	Patch panel MGK 48x 19"/1.5U for 48x module with Keystone fitting	grey, RAL7035	1 pc.

Article No.	Accessories/Description	Colour (similar to)	PU
418010	Blank cover for Keystone openings	white	10 pcs.
418011	Blank cover for Keystone openings	black	10 pcs.

COPPER PATCH PANEL

Patch panel MS-K 24x

for 24 RJ45 modules MS-K 1/8

shielded



Blank covers,
black and white



Patch panel MS-K 24x, shielded

PRODUCT INFORMATION

APPLICATION

Screened 19"/1U patch panel for up to 24 shielded RJ45 modules MS-K Plus 1/8 Cat. 6/E_A. Snap-in modules can be easily fitted into the patch panel. Unused ports can be covered with blank covers.

DESCRIPTION

Front stainless steel or light grey, similar to RAL 7035. Front imprint with numbers 1 to 24. Possibility to connect to equipotential bonding. Delivery without modules.

Suitable for the following Datwyler module:

- RJ45 module MS-K 1/8 Cat. 6/E_A shielded

DIMENSIONS

Width 482 mm (19")
Depth 110 mm (including cable strain relief)
Height 44 mm (1U)

Article No.	Description	Colour (similar to)	PU
440040	Patch panel MS-K 24x, 19"/1U, for 24x RJ45 module MS-K 1/8 (delivery without modules)	front stainless steel	1 pc.
440041	Patch panel MS-K 24x, 19"/1U, for 24x RJ45 module MS-K 1/8 (delivered without modules)	front RAL 7035	1 pc.

Article No.	Accessories/Description	Colour (similar to)	
418010	Blank cover for Keystone openings (1 set = 10 pcs.)	white	1 set
418011	Blank cover for Keystone openings (1 set = 10 pcs.)	black	1 set

Patch panels MPS 12x, 16x, 24x for modules MS 1/8 or PS-TERA 4P shielded

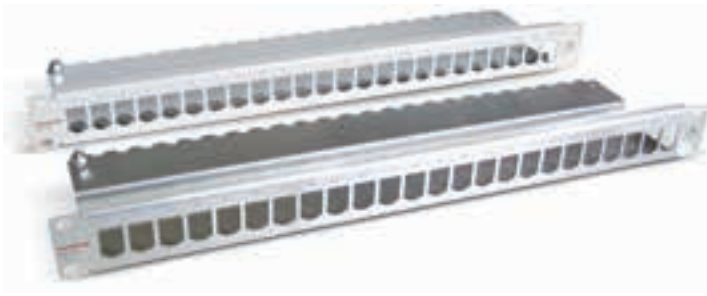

Patch panel MPS 24x, shielded



Patch panel MPS 12x, shielded

Blank cover MS,
white or light grey

PRODUCT INFORMATION

APPLICATION Shielded 19"/1U and 10"/1U patch panels for up to 12, 16 or 24 modules.
The modules can be easily fitted into the patch panels.

DESCRIPTION Front stainless steel or light grey, similar to RAL 7035.
Front imprint with numbers.
Delivery without modules.

Suitable for the following Datwyler modules:

- PS-TERA 4P shielded
- RJ45 module MS-C6_A 1/8 Cat. 6_A shielded
- RJ45 module MS 1/8 Cat. 6/E_A shielded
- RJ45 feed-trough coupler, shielded, Cat. 6 Link / Class E, 180° (straight)
- Blank cover MS for unused openings
- other modules with MS adapter

DIMENSIONS Width 19" or 10"
Height 1U

Article No.	Description	Colour (similar to)	PU
185840	Patch panel MPS 24x, 19"/1U, for 24 modules (delivery without modules)	light grey, RAL 7035	1 pc.
185841	Patch panel MPS 24x, 19"/1U, for 24 modules (delivery without modules)	stainless steel blank	1 pc.
185846	Patch panel MPS 24x, 19"/1U, for 24 modules (delivery without modules)	black, RAL 9005	1 pc.
184 099	Patch panel MPS 12x, 10"/1U, for 10 modules (delivery without modules)	light grey, RAL 7035	1 pc.
417444	Patch panel MPS 12x, 10"/1U, for 10 modules (delivery without modules)	stainless steel blank	1 pc.
417480	Patch panel MPS 16x, 19"/1U, for 16 modules (delivery without modules)	light grey, RAL 7035	1 pc.

Article No.	Accessories/Description	Colour (similar to)	PU
417446	RJ45 feed-trough coupler, shielded, Cat. 6 Link / Class E, 180° (straight)	metal	10 pcs.
417447	LC-Duplex coupler with MS adapter, MM ceramic		10 pcs.
417448	LC-Duplex coupler with MS adapter, SM ceramic		10 pcs.
185731	 Fastening kit (8 of each: screws, washers and captive nuts)		1 set
190977	Blank cover for unused MS openings	light grey	1 pc.
309213	Blank cover for unused MS openings	white	1 pc.

COPPER PATCH PANEL

Patch panel MS 24/8

for 24 modules MS 1/8 or MU 1/8

shielded and unshielded



Patch panel MS 24/8

PRODUCT INFORMATION

APPLICATION Shielded 19"/1U patch panel for up to 24 RJ45 modules shielded and/or unshielded.

DESCRIPTION Anodised aluminium, silver, and light grey plastic, similar to RAL 7035. Snap-in modules can be easily fitted into the patch panel. The patch panel is supplied with dust shutters and labelling fields. The dust shutters can be individually replaced. Delivery without modules.

Suitable for the following Datwyler modules:

- RJ45 module MS-C6_A 1/8 Cat. 6_A shielded
- RJ45 module MS 1/8 Cat. 6/E_A shielded
- RJ45 module MU 1/8 Cat. 6 unshielded
- RJ45 feed-trough coupler, shielded, Cat. 6 Link / Class E, 180° (straight)
- other modules with MS adapter

DIMENSIONS Width 19"
Height 1U

ACCESSORIES Dust shutters in various colours



Article No.	Description	Colour (similar to)	PU
185680	Patch panel MS 24/8 Cat. 6, 19"/1U, for 24x MS 1/8 Cat.6 (delivery without modules)	light grey, RAL 7035	1 pc.

Article No.	Accessories/Description	Colour	PU
185711	Dust shutter for Patch Panel MS 24/8	yellow	10 pcs.
185712	Dust shutter for Patch Panel MS 24/8	blue	10 pcs.
185713	Dust shutter for Patch Panel MS 24/8	green	10 pcs.
185714	Dust shutter for Patch Panel MS 24/8	red	10 pcs.
190984	Dust shutter for Patch Panel MS 24/8	orange	10 pcs.
190985	Dust shutter for Patch Panel MS 24/8	black	10 pcs.
190986	Dust shutter for Patch Panel MS 24/8	violet	10 pcs.
185717	 Labeling sheet A4 for patch panel MS 24/8	white	10 sheets
185731	Fastening kit (8 of each: screws, washers and captive nuts)		1 set

MS 24/8 0714/e



Blank covers,
black and white

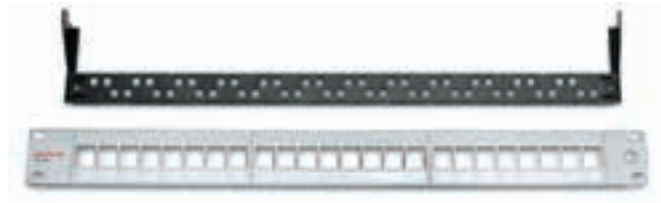

Patch panel KU 24x, unshielded

PRODUCT INFORMATION

APPLICATION Unshielded 19"/1U patch panel for up to 24 RJ45 Keystone modules KU-T 1/8, unshielded, in accordance with Cat. 6 or Cat.5e (UTP). Snap-in modules can be easily fitted into the patch panel. Unused ports can be covered with blank covers.

DESCRIPTION Patch panel made of flame retardant compound, UL94V-0 rated. Front in grey, similar to RAL 7035, or in black, similar to RAL 9005. Strain relief with tie wrap. Delivery without modules.

Suitable for the following Datwyler module:
 - RJ45 module KU-T 1/8 Cat. 6 / Cat. 5e unshielded

DIMENSIONS

Width	482 mm (19")
Depth	80 mm (including cable strain relief)
Height	44 mm (1U)

Article No.	Description	Colour (similar to)	PU
418021	Patch panel KU 24x, 19"/1U, for 24x RJ45 Keystone module UTP (delivery without modules)	grey, RAL 7035	1 pc.
418022	Patch panel KU 24x, 19"/1U, for 24x RJ45 Keystone module UTP (delivery without modules)	black, RAL 9005	1 pc.

Article No.	Accessories/Description	Colour (similar to)	PU
418010	Blank cover for Keystone openings	white	10 pcs.
418011	Blank cover for Keystone openings	black	10 pcs.

COPPER PATCH PANEL

Patch panel MU 24x

for 24 modules MU 1/8

unshielded



Patch panel MU 24x, unshielded

PRODUCT INFORMATION

APPLICATION Unshielded 19"/1U patch panel for up to 24 RJ45 modules MU 1/8, unshielded. The snap in modules can be easily fitted into the patch panel.

DESCRIPTION Front light grey, similar to RAL 7035. Delivery without modules.

Suitable for the following Datwyler module:
- RJ45 module MU 1/8 Cat. 6 unshielded

DIMENSIONS

Width	19"
Height	1U

Article No.	Description	Colour (similar to)	PU
185842	Patch panel MU 24x, 19"/1U, for 24x RJ45 module MU 1/8, unshielded (delivery without modules)	light grey, RAL 7035	1 pc.

Article No.	Accessories/Description	Colour (similar to)	PU
185750	RJ45 module MU 1/8 Cat. 6 unshielded, colour code T568-A	white	10 pcs.
185751	RJ45 module MU 1/8 Cat. 6 unshielded, colour code T568-B	white	10 pcs.
185731	Fastening kit (8 of each: screws, washers and captive nuts)		1 set
1409558	Blank cover for unused MU openings	white	10 pcs.
1409559	Blank cover for unused MU openings	black	10 pcs.

Subrack 19"/3U and 10"/3U for plug-in modules 7HP/3U with up to 6 RJ45 modules



Fig. 1:
Subrack
19"/3U



Fig. 2:
Plug-in module for
6x MS 1/8



Fig. 3:
Plug-in module for
6x MS-K 1/8



Fig. 4:
Plug-in module with
6x RJ45 Cat.3



Fig. 5:
Blank cover
7HP/3U

PRODUCT INFORMATION

APPLICATION & DESCRIPTIONS

Subrack, 19"/3U (see Fig. 1)
for the insertion of a maximum of 12 plug-in modules 7HP/3U.
Delivery without fastening kit and plug-in modules.

Subrack, 10"/3U (similar to Fig. 1)
for the insertion of a maximum of 5 plug-in modules 7HP/3U.
Delivery without fastening kit and without plug-in modules.

Plug-in module, loaded with 6 RJ45 modules (see Fig. 2 and 3, selection/types see below)

Plug-in module, loaded with 6 RJ45 Cat. 3 modules (telephony, see Fig. 4)
with LSA Plus IDC termination.

ACCESSORY

Blank cover (see Fig. 5)
for covering the spare places in the subrack that are not occupied by plug-in modules.

Article No.	Fig.	Description	Colour (similar to)	PU
185682	1	Subrack 19"/3U	aluminum, silver	1 unit / box
185683	-	Subrack 10"/3U	aluminum, silver	1 unit / box
185681	2	Plug-in module for 6x RJ45 module MS 1/8 or MS-C6 1/8 (without modules)	aluminum, silver	1 unit / box
440046	-	Plug-in module for 6x RJ45 module Keystone (without modules)	stainless steel, blank	1 unit / box
440055	3	Plug-in module for 6x RJ45 module Keystone (without modules)	black	1 unit / box
185724	4	Plug-in module, loaded with 6x RJ45 modules, Cat. 3 (telephony), 7HP/3U	aluminum, silver	1 unit / box
185718	5	Blank cover 7HP/3U	aluminum, silver	1 unit / box
185716		Labelling sheets A4 for plug-in module for 6x MS	white	10 sheets
185731	-	Fastening kit (8 of each: screws, washers and captive nuts)		1 set
440059	-	Labelling strip for Plug-in module		1 pc.

COPPER PATCH PANEL

AP Distribution box MS 6x

surface mounted
for one insert



Example: AP Distribution box MS 6x with plug-in module and RJ45 jacks

Plug-in module for 6 RJ45 modules MS 1/8, shielded, or MS-C6_A 1/8, 180°, shielded

Plug-in module, loaded with 6 RJ45 jacks Cat. 3 (telephony)

PRODUCT INFORMATION

APPLICATION

Surface-mount distribution box for the insertion of one plug-in module for 6x MS 1/8 or one plug-in module with 6x RJ45 Cat. 3 jacks. Delivery without plug-in modules and without RJ45 modules.

DESCRIPTION

Distribution box delivered with labelling strip. The box can be equipped with a Cat. 3 telephony plug-in module or with a plug-in module for 6 RJ45 modules MS 1/8 Cat. 6/E_A or MS-C6_A 1/8 Cat. 6_A. When MS 1/8 modules are required, the metal insert for 6x MS 1/8 (or MS-C6_A 1/8) is necessary.

Colour grey, similar to RAL 7035

DIMENSIONS

W x H x D 122 x 41 x 120 mm

Article no.	Description	Colour (similar to)	PU
185685	AP distribution box for one plug-in module (delivery without plug-in module)	light grey, RAL 7035	1 unit / box
185727	Plug-in module for 6x RJ45 module MS 1/8 Cat. 6/E _A (delivery without modules)	metal	1 pc.
185729	Plug-in module with 6 RJ45 jacks Cat. 3 for telephony	metal	1 pc.

Article no.	Accessories/Description	Colour (similar to)	PU
190977	Blank cover for unused MS openings	grey	10 pcs.

MS couplers
for MS patch panels and data outlets



Blank cover for MS opening



Coax coupler MS
with F jack, IEC jack,
IEC plug



LC duplex coupler MS

PRODUCT INFORMATION

DESCRIPTION

Blank coupler for MS openings

For closing unused ports in all MS patch panels, MS data outlets and so on.

DESCRIPTION

Coax couplers for MS openings

Available for

- a) F jack, 75 Ohm
- b) IEC jack, 75 Ohm
- c) IEC plug, 75 Ohm

DESCRIPTION

LC duplex couplers for MS openings

Available for single-mode (SM) and multimode (MM)

NOTE: To be able to maintain the permitted bending radius of the fibre optic cable please take care for sufficient spare place (FO cable plus LCD connector) already in the planning phase.

Article No.	Description	Colour (similar to)	PU
190977	Blank cover MS for covering unused MS openings	light grey	1 pc.
309213	Blank cover MS for covering unused MS openings	white	1 pc.
417447	LC duplex coupler MS, MM ceramic	light grey	1 pc.
417448	LC duplex coupler MS, SM ceramic	light grey	1 pc.
417450	Coax coupler MS, type F jack/type F jack, 75 Ohm	light grey	1 pc.
on request	Coax coupler MS, type IEC jack, 75 Ohm	light grey	1 pc.
on request	Coax coupler MS, type IEC plug, 75 Ohm	light grey	1 pc.

PATCH PANEL ACCESSORIES

KS couplers

for Keystone patch panels and data outlets



Blank cover for Keystone opening,
white and black



LC duplex coupler KS
for multimode, grey



LC duplex coupler KS
for single-mode, blue

PRODUCT INFORMATION

DESCRIPTION

Blank cover for Keystone opening

For closing unused ports in all Keystone patch panels, Keystone data outlets and so on.

DESCRIPTION

LC duplex coupler for Keystone openings

Available for

- a) Multimode (MM) with ceramic sleeve in grey and dust protection
- b) Single-mode (SM) with ceramic sleeve in blue and dust protection

NOTE: To be able to maintain the permitted bending radii of the fibre optic cables please take care for sufficient spare place (FO cable plus LCD connector) already in the planning phase.

Article No.	Description	Colour (similar to)	PU
418010	Blank cover KS for covering Keystone openings (1 set = 10 pcs.)	white	1 set
418011	Blank cover KS for covering Keystone openings (1 set = 10 pcs.)	black	1 set
418013	LC Duplex coupler KS, MM ceramic (for Keystone panels)	grey	1 pc.
418014	LC Duplex coupler MS, SM ceramic (for Keystone panels)	blue	1 pc.

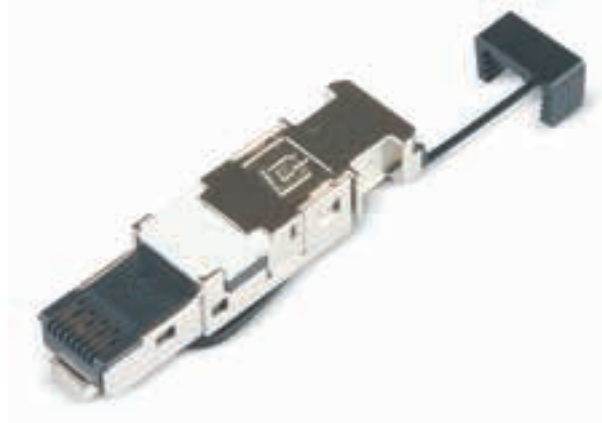

PRODUCT INFORMATION

APPLICATION Structured premises cablings in the industrial sector, for the transmission of Ethernet protocols.

DESCRIPTION Field assembly 8-pin RJ45 plug, IP20, Category 6, shielded, with quick connection technology.

Suitable for cables with the following properties:

Solid copper wire	0.40 mm up to 0.64 mm, AWG 24/1 up to AWG 22/1
Stranded copper wire	0.48 mm up to 0.67 mm, AWG 26/7 up to AWG 22/7
Cable sheath diameter	5.5 mm up to 8.5 mm
Protection rating	IP20

Solid housing made of zinc die cast.
 Easy on-site assembly without any special tools.
 With strain relief - can be installed afterwards for colour coding.

APPLICABLE STANDARDS IEC 60603-7-5 (Cat. 6)
 ISO/IEC 11801:2002/Amd.1:2008 and Amd.2:2010 (Class E, 250 MHz)
 EN 50173-1:2007

Articel No.	Description	Colour	PU
417522	RJ45 plug IP20 Cat. 6 shielded for field assembly	black	1 pc.

Copper

Fibre Optics

Cabinets & Racks

Data Centre

Wireless

Multimedia

General Information

RJ45 IP20 Cat.6 0714/e

INDUSTRIAL

RJ45 plug IP20 Cat.5e

shielded

field assembly



PRODUCT INFORMATION

APPLICATION Structured premises cablings in the industrial sector, for the transmission of Ethernet protocols.

DESCRIPTION Field assembly 8-pin RJ45 plug, IP20, Cat.5e shielded, with quick connection technology.

Suitable for cables with the following properties:

Solid copper wire	0.40 mm up to 0.64 mm, AWG 24/1 up to AWG 22/1
Stranded copper wire	0.48 mm up to 0.67 mm, AWG 26/7 up to AWG 22/7
Cable sheath diameter	5.0 mm up to 8.5 mm
Protection rating	IP20

The plug is pre-assembled and therefore allows for easy on-site assembly without any special tools.

APPLICABLE STANDARDS EC 60603-7-3 (Cat.5/5e)
ISO/IEC 11801:2002/Amd.1:2008 and Amd.2:2010 (Class D, 100 MHz)
EN 50173-1:2007

DIMENSIONS

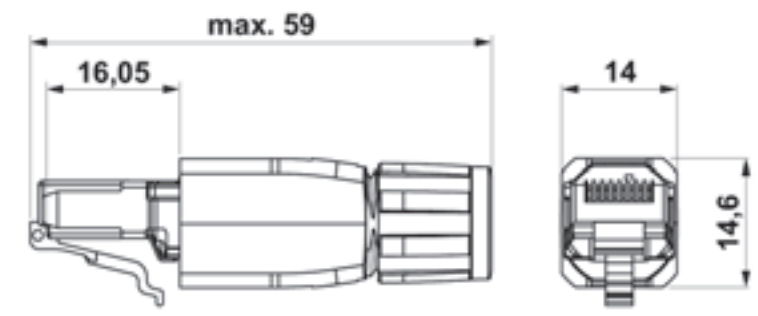

Articel No.	Description	Colour (similar to)	PU
417521	RJ45 plug IP20 Cat.5/5e screened for field assembly	grey, RAL 7035	1 pc.

Copper

Fibre Optics

Cabinets & Racks

Data Centre

Wireless

Multimedia

General Information

RJ45 IP20 Cat.5/5e 0714/e



PRODUCT INFORMATION

APPLICATION	Structured premises cabling in the industrial sector, for the transmission of Ethernet protocols.								
DESCRIPTION	Field-assembly 8-pin RJ45 plug body, IP67, Category 5e, shielded, with quick connection technology.								
	<p>Suitable for cables with the following properties:</p> <table border="0"> <tr> <td>Solid copper wire</td> <td>0.40 mm up to 0.64 mm, AWG 24/1 up to AWG 22/1</td> </tr> <tr> <td>Stranded copper wire</td> <td>0.48 mm up to 0.67 mm, AWG 26/7 up to AWG 22/7</td> </tr> <tr> <td>Cable sheath diameter</td> <td>5.0 mm up to 8.5 mm</td> </tr> <tr> <td>Protection rating</td> <td>IP67</td> </tr> </table> <p>The plug is pre-assembled and therefore allows for easy on-site assembly without any special tools. The easy to handle push-pull interlock protects the connection against shock and vibration and ensures safe data transmissions also in rough industrial environments.</p>	Solid copper wire	0.40 mm up to 0.64 mm, AWG 24/1 up to AWG 22/1	Stranded copper wire	0.48 mm up to 0.67 mm, AWG 26/7 up to AWG 22/7	Cable sheath diameter	5.0 mm up to 8.5 mm	Protection rating	IP67
Solid copper wire	0.40 mm up to 0.64 mm, AWG 24/1 up to AWG 22/1								
Stranded copper wire	0.48 mm up to 0.67 mm, AWG 26/7 up to AWG 22/7								
Cable sheath diameter	5.0 mm up to 8.5 mm								
Protection rating	IP67								
APPLICABLE STANDARDS	IEC 60603-7-3 (Cat. 5/5e) ISO/IEC 11801:2002/Amd.1:2008 and Amd.2:2010 (Class D, 100 MHz) EN 50173-1:2007								

DIMENSIONS

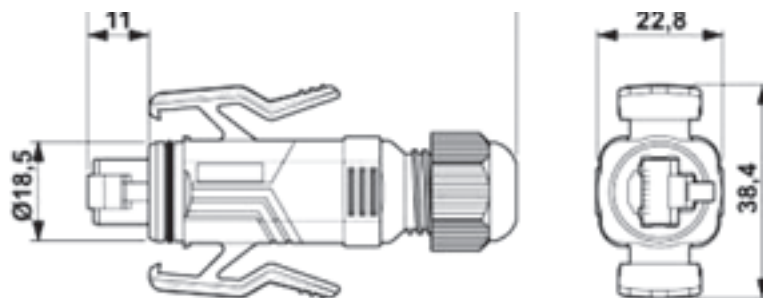

Articel No.	Description	Colour (similar to)	PU
417520	RJ45 plug IP67 Cat. 5/5e shielded for field assembly	grey, RAL 7035	1 pc.

INDUSTRIAL

Outlets IP67

surface mounted & installation in devices
for 1 RJ45 module MS 1/8 or MU 1/8



Fig. 1:
Data outlet IP67



Fig. 2:
Connector socket IP67



Fig. 3:
Mounting flange IP67



Fig. 4:
RJ45 plug body IP67
to assemble patch cables on-site

PRODUCT INFORMATION

APPLICATION

Structured premises cablings in the industrial sector - components with protection rating IP67 in accordance with EN 50173-2 (draft) and environment classes M3, I3, C3, and E3.

DESCRIPTION

Data outlets IP67 for 1 RJ45 module MS 1/8 (shielded) or MU 1/8 (unshielded) for the transmission of Ethernet protocols in harsh industrial environments in which contaminations may occur:

1. Data outlet IP67 for 1 module MS 1/8 shielded or MU 1/8 unshielded - surface mounted
2. Connector socket IP67 for 1 module MS 1/8 shielded or MU 1/8 unshielded
3. Mounting flange IP67 for 1 module MS 1/8 shielded or MU 1/8 unshielded - for installation in devices
4. RJ45 plug body IP67 - to assemble IP67 patch cables on-site

In order to ensure a secure data transmission, the compatible components offer a large 360° braided connection that results in excellent EMC properties. The covers that are permanently attached to the casings prevent water, dust, dirt and other contaminants from entering the RJ45 jack when unmated. Usable in connection with IP67 or standard RJ45 patch cords in different lengths.

FEATURES

- Fulfill protection rating IP67 when connected to an IP67 plug
- Connection with customary RJ45 plugs possible (without IP rating)
- Plug surface in accordance with IEC 61076-3-106 (option 6)
- Environment classes M3, I3, C3, and E3 in accordance with EN50173-2
- IP67 cover, permanently attached
- Large 360° braided connection, excellent EMC properties
- Add-on surface mounting possibility
- Easy to open modules, reusable
- Add-on unit with an 8-pin RJ45 jack
- Easy and time-saving installation
- Fully shielded modules

DIMENSIONS

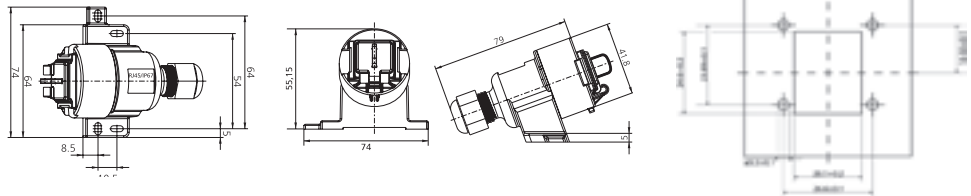

Article No.	Fig.	Description	Colour (similar to)	PU
185719	1	Data outlet IP67 for 1x MS/MU 1/8 (delivery without module)	grey, RAL 7035	1 pc.
185725	2	Connector socket IP67 for 1x MS/MU 1/8 (delivery without module)	grey, RAL 7035	1 pc.
185726	3	Mounting flange IP67 for 1x MS/MU 1/8 (delivery without module)	grey, RAL 7035	1 pc.
417520	4	RJ45 plug IP67 Cat.5/5e shielded for field assembly	grey, RAL 7035	1 pc.
185700		RJ45 module MS 1/8 Cat. 6/E, shielded	metallic	10 pcs.
185750		RJ45 module MU 1/8 Cat. 6 unshielded	white	10 pcs.

INDUSTRIAL
AP Outlet IP67
 surface mounted
 for 2 modules



RJ45 outlet IP67...

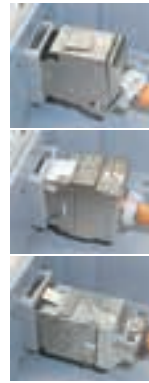

MS-K Plus 1/8 Cat. 6_A (IEC)

KS-T 1/8 Cat. 6/E_A
 KS-T 5 1/8 Cat. 5/5e
 KS-T Plus 1/8 Cat. 6_A tool-less
 KS-TS 1/8 Cat. 6/E_A tool-less slimline

PS-GG45 7_A

... for the assembly of 2 shielded Datwyler modules (see above)

PRODUCT INFORMATION

APPLICATION Structured premises cablings in the industrial sector, for the transmission of Ethernet protocols.

DESCRIPTION Outlet IP67, surface mounted, for 2 modules (types see above).
 For information on the properties of the module: see data sheet of the requested module.
 Protection rating IP67 when used together with RJ45 patch cords IP67.
 Protection rating IP20 when used together with standard RJ45 patch cords.
 Gasket for the incoming data cables with PG gland.
 Stable housing made of aluminium, grey, similar to RAL 7035.
 Wall-/floor mounting by internal screw openings.
 Delivery without modules.

DIMENSIONS W x H x D = 125 x 80 x 58 mm

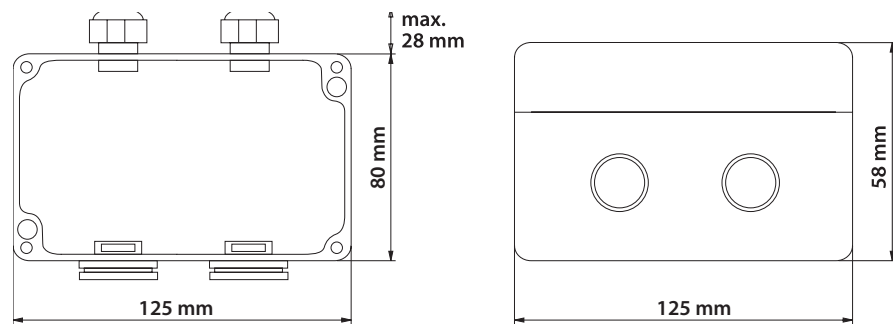

Article No.	Description	Colour (similar to)	PU
417530	AP outlet IP67 for 2 modules (delivery without modules)	grey, RAL 7035	1 pc.

INDUSTRIAL

AP Outlet IP44

surface mounted

for 2 modules



AP outlet IP44 for 2 modules, surface mounted



MS 1/8 Cat. 6/E_A shielded
 MU 1/8 Cat. 6 unshielded
 MS-C6_A 1/8 Cat. 6_A shielded

MS-K 1/8 Cat. 6/E_A shielded
 MS-K Plus 1/8 Cat. 6_A shielded

KS-T 1/8 Cat. 6/E_A shielded
 KS-T 5 1/8 Cat. 5/5e shielded
 KU-T 1/8 Cat. 6 unshielded
 KU-T 1/8 Cat. 5/5e unshielded
 KS-TS 1/8 Cat. 6/E_A tool-less slimline shielded
 KS-T Plus 1/8 Cat. 6_A tool-less shielded

PS-GG45 7_A shielded

Same box, same insertion element

PRODUCT INFORMATION

APPLICATION

Structured premises cablings in the industrial sector, for the transmission of Ethernet protocols.

DESCRIPTION

Outlet IP67, surface mounted, for 2 modules (types see above).
 For information on the properties of the module: see data sheet of the requested module.
 Cable entry from the top (one or two cables).
 Shatter-proof, stable housing, grey, similar to RAL 7035.
 Protection rating IP44 when closed only (without patch cords).
 Delivery without modules.

DIMENSIONS

W x H x D = 85 x 57 x 75 mm

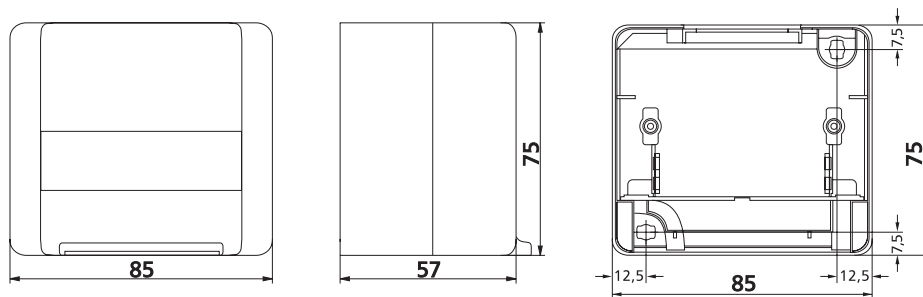

Article No.	Description	Colour (similar to)	PU
185728	AP Outlet IP44 for 2x MS/MU 1/8 (delivery without modules)	grey, RAL 7035	1 pc.
417510	AP Outlet IP44 for 2x modules with Keystone Clip (delivery without modules)	grey, RAL 7035	1 pc.



Surface mounted (AP) version



Duct mounted (UP-K) version

PRODUCT INFORMATION

APPLICATION Structured premises cablings in the industrial sector, for the transmission of Ethernet protocols.

DESCRIPTION Wall outlet IP44, surface or duct mounted, for 2 modules.

Suitable for the following Datwyler modules:

- PS-GG45 7_A shielded
- RJ45 module MS-K 1/8 Cat. 6/E_A shielded
- RJ45 module MS-K Plus 1/8 Cat. 6_A shielded
- RJ45 module MS-C6_A 1/8 Cat. 6_A shielded
- RJ45 module KS-T 1/8 Cat. 6/E_A tool-less shielded
- RJ45 module KS-TS 1/8 Cat. 6/E_A tool-less shielded
- RJ45 module KS-T Plus 1/8 Cat. 6_A tool-less shielded

For information on the properties of the module: see data sheet of the requested module.

Lockable outlet with protection rating IP44.
Cover can also be locked with connected patch cords.
One-key system.
Cable entry from the top (one or two cables).
Shatter-proof, stable housing, grey, similar to RAL 7035.
Delivery without modules.

DIMENSIONS

Surface mounted version	W x H x D = about 90 x 93 x 90 mm
Duct mounted version	W x H x D = about 90 x 93 x 32 mm

Article No.	Description	Colour (similar to)	PU
417500	UP-K Wall outlet IP44, duct mounted, for 2x MS/MU 1/8 (delivery without modules)	grey, RAL 7035	1 pc.
417501	AP Wall outlet IP44, surface mounted, for 2x MS/MU 1/8 (delivery without modules)	grey, RAL 7035	1 pc.
417503	AP Wall outlet IP44, surface mounted, for 2x Keystone module (delivery without modules)	grey, RAL 7035	1 pc.

INDUSTRIAL

NAP / NUP Wall outlet IP55

surface / flush mounted in plumbed rooms

for 2 modules

 SWISS STANDARD



Flush mounted version, IP55



Surface mounted version, IP55

PRODUCT INFORMATION

APPLICATION

In structured premises cablings in the industrial sector, especially in high-humidity rooms, for the transmission of Ethernet protocols.

DESCRIPTION

Wall outlet IP 55, for high-humidity rooms, surface mounted (NAP) or flush mounted (NUP), for a maximum of 2 modules.

Suitable for the following Datwyler modules:

- PS-GG45 7_A 4P shielded
- RJ45 module KS-T 1/8 Cat. 6/E_A tool-less shielded
- RJ45 module MS-C6_A 1/8 Cat. 6_A shielded (Keystone version)

Protection rating IP55 when closed only.
Shatter-proof housing, similar to RAL 9010.
Cable entry from above or from below.
Delivery without modules.

Article No.	Description	Colour (similar to)	PU
309242	 NAP Wall outlet IP55 for 2 modules (delivery without modules)	RAL 9010	1 pc.
309243	 NUP Wall outlet IP55 for 2 modules (delivery without modules)	RAL 9010	1 pc.

Rail adapter MS IP20 rail mounted

for 1 RJ45 module MS 1/8 or MS-C6_A 1/8

Rail adapter for 1 RJ45 module
MS 1/8 or MS-C6_A 1/8

PRODUCT INFORMATION

APPLICATION	Structured premises cabling in the industrial sector, for the transmission of Ethernet protocols.
DESCRIPTION	<p>IP20 protection rating rail adapter for 1 shielded RJ45 module MS 1/8 Cat. 6/E_A or MS-C6_A 1/8 Cat. 6_A (IEC) - can be fitted onto any 35 mm standard (DIN) rail. The RJ45 module is protected by a cover against direct contact. Protection class II without connection to electrical grounding. When installed as part of a protection class I system, the electrical grounding can be realized by means of an integrated spring via the rail. Its width allows for installations of up to 12 RJ45 modules in a row in any standard electrical distributor.</p> <p>Suitable for the following Datwyler modules:</p> <ul style="list-style-type: none"> - RJ45 module MS 1/8 Cat. 6/E_A shielded - RJ45 module MU 1/8 Cat. 6 unshielded - RJ45 module MS-C6_A 1/8 Cat. 6_A shielded
FEATURES	<ul style="list-style-type: none"> - Rail mounted onto TH35 rails (in accordance with DIN EN60715) - W = 1 width unit (< 18mm) (DIN 43880) - Integrated grounding spring (removable) - Colour: light grey, similar to RAL 7035 - Protection class I or II, depending on way of installation - Protection rating IP20 - Protective window for labelling strips - Integrated dust shutter

DIMENSIONS



Article No.	Description	Colour (similar to)	PU
309188	Rail adapter for 1x MS-C6 _A 1/8 or MS 1/8	light grey, RAL 7035	1 pc.
185700	RJ45 module MS 1/8 Cat. 6/E _A shielded, T568-A	metal	10 pcs.
309250	Module MS-C6 _A 1/8 Cat. 6 _A (IEC) 180°	metal	10 pcs.

INDUSTRIAL

Rail adapter MS-K IP20

rail mounted

for 1 RJ45 module MS-K 1/8 or MS-K Plus 1/8



Rail adapter for 1 RJ45 module
MS-K 1/8 or MS-K Plus 1/8

PRODUCT INFORMATION

APPLICATION

Structured premises cablings in the industrial sector, for the transmission of Ethernet protocols.

DESCRIPTION

IP20 protection rating rail adapter for 1 shielded RJ45 module MS-K 1/8 Cat. 6/E_A or MS-K Plus 1/8 Cat. 6_A (IEC) - can be fitted onto any 35 mm standard (DIN) rail. The RJ45 module is protected by a cover against direct contact. Protection class II without connection to electrical grounding. Protection class I when installed with connection to electrical grounding. Its width allows for installations of up to 12 RJ45 modules in a row in any standard electrical distributor.

Suitable for the following Datwyler modules:

- RJ45 module MS-K 1/8 Cat. 6/E_A shielded
- RJ45 Module MS-K Plus 1/8 Cat. 6_A shielded

FEATURES

- Rail mounted onto TH35 rails (in accordance with DIN EN60715)
- W = 1 width unit (18mm) (DIN 43880)
- Colour: light grey, similar to RAL 7035
- Protection class I or II, depending on way of installation
- Protection rating IP20
- Protective window for labelling strips
- Integrated dust shutter

DIMENSIONS

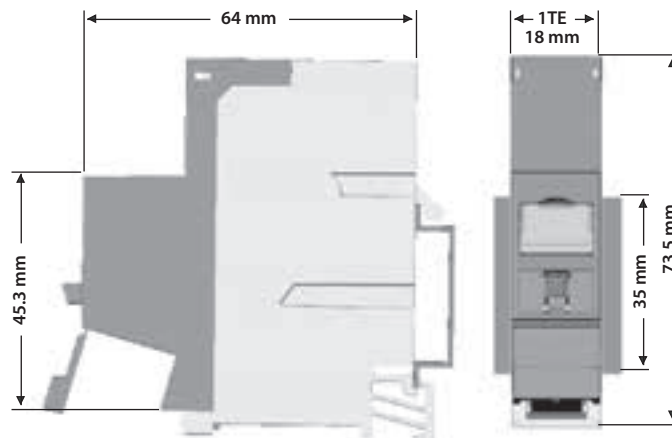

Article No.	Description	Colour (similar)	PU
440018	Rail adapter for 1x MS-K (delivery without module)	light grey, RAL 7035	1 pc.
440004	RJ45 module MS-K Plus 1/8 Cat. 6 _A (IEC), with colour code TIA 568-A	metal	10 pcs.

REG-Adapter MS-K-0714/e

Rail adapter Keystone IP20 rail mounted

for 1 Keystone module

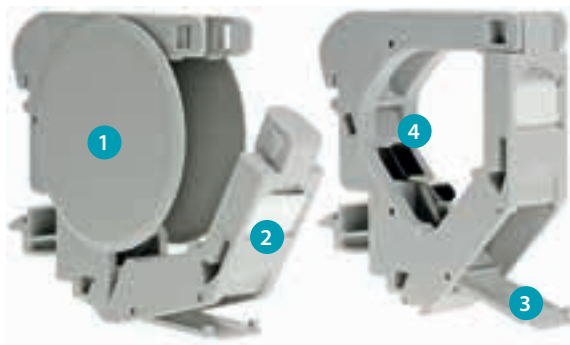

1 Side cover
2 Labelling field

3 Dust shutter
4 Grounding spring



Rail adapter
for 1 Keystone module (types see below)

PRODUCT INFORMATION

APPLICATION

Structured premises cabling in the industrial sector, for the transmission of Ethernet protocols.

DESCRIPTION

IP20 protection rating rail adapter for 1 shielded or unshielded module with Keystone fitting. Can be fitted onto any 35 mm standard (DIN) rail - there must be a minimum distance of 10 mm between the rail and the back plane for fitting the rail adapter.

Plastic housing with labelling field and dust shutter.

Electrical grounding realized by means of an integrated grounding spring (via rail).

Its width allows for installations of up to 12 modules in a row in any standard electrical distributor.

When several rail adapters are fitted in rows two side covers (1.5 mm each) are needed to terminate them and ensure IP20 protection rating.

Delivery without module.

Suitable for the following Datwyler modules:

- RJ45 module KS-T Plus 1/8 Cat. 6_A shielded
- RJ45 module KS-T 1/8 Cat. 6/E_A shielded
- RJ45 module KS-TS 1/8 Cat. 6/E_A shielded
- RJ45 module KS-T 5 1/8 Cat. 5e shielded
- RJ45 module KU-T 1/8 Cat. 6 unshielded
- RJ45 module KU-T 1/8 Cat. 5e unshielded

FEATURES

- Rail mounted onto TH35 rails (in accordance with DIN EN60715)
- W = 1 width unit (18mm) (DIN 43880)
- with integrated labelling field

DIMENSIONS

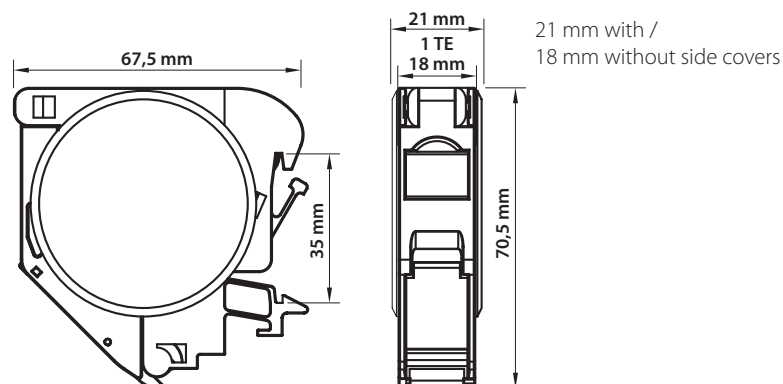

Article No.	Description	Colour (similar)	PU
418026	Rail adapter Keystone IP20 for 1 module with Keystone fitting (delivery without module)	grey	1 pc.

INDUSTRIAL

Rail adapter Keystone

rail-mounted

for 1 RJ45 module KS-T, KS-TS or KU-T



Rail adapter for
1 RJ45 module KS-T, KS-TS or KU-T

PRODUCT INFORMATION

APPLICATION

Structured premises cabling in the industrial sector, for the transmission of Ethernet protocols.

DESCRIPTION

Rail adapter for 1 tool-less RJ45 Keystone module KS-T, KS-TS (Slimline) or KU-T.

Can be fitted onto any 35 mm standard (DIN) rail.

Made of stainless steel, therefore always electrically conducted (via rail) with the building's equipotential bonding.

Its width allows for installations of up to 12 modules in a row in any standard electrical distributor.

Delivery without module.

Suitable for the following Datwyler modules:

- PS-GG45 7_A shielded
- RJ45 module KS-T Plus 1/8 Cat. 6_A shielded
- RJ45 module KS-T 1/8 Cat. 6/E_A shielded
- RJ45 module KS-TS 1/8 Cat. 6/E_A shielded
- RJ45 module KS-T 5 1/8 Cat. 5e shielded
- RJ45 module KU-T 1/8 Cat. 6 unshielded
- RJ45 module KU-T 1/8 Cat. 5e unshielded

FEATURES

- Rail mounted onto TH35 rails (in accordance with DIN EN60715)
- W = 1 width unit (< 18mm) (DIN 43880)
- with labelling field

DIMENSIONS

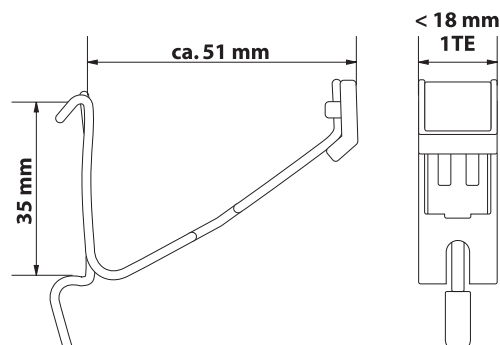

Article No.	Description	Colour (similar)	PU
418025	Rail adapter Keystone for 1x KS-T/KU-T (delivery without module)	metal	1 pc.

REG KS 0714/e

Management panels & cable shelves, 19"/1U

in different versions



19"/1U management panel,
versions made of stainless steel,
with 5 support brackets

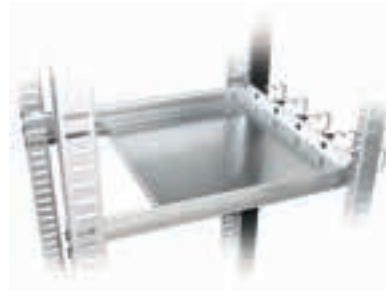

19" cable shelf with management panel



19" cable shelf with cable feed-
through panel and brush strip

PRODUCT INFORMATION

APPLICATION

19" management panels are suitable for the proper routing of copper and fibre optic cables, particularly suitable for patch cords in racks or cabinets with 19" mounting angles and rails.

Cable shelves fulfil the same function, particularly for multiple (trunk) cables.

DESCRIPTION

19"/1U basic management panels, available in three versions:
a) stainless steel, b) black or c) grey.

These panels come without support brackets.
They can be fitted with 5 support brackets in the required dimension.
Please order the support brackets separately!

There are labelling strips
for complete management panels
with support brackets
available:

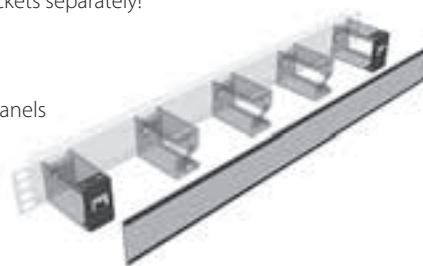

Article No.	Description	Colour/Material	PU
1411480	Support bracket 30 mm	plastic, black	1 pc.
1411481	Support bracket 75 mm	metal	1 pc.
1411482	Support bracket 110 mm	metal	1 pc.
1411604	Management panel, 19"/1U, for 5 support brackets (delivery without brackets)	RAL 7035	1 pc.
1407689	Management panel, 19"/1U, for 5 support brackets (delivery without brackets)	RAL 9005	1 pc.
418200	Management panel, 19"/1U, for 5 support brackets (delivery without brackets)	stainless steel, blank	1 pc.
401240	19" blank plate, 1U	RAL 7035	1 pc.
401241	19" blank plate, 1U	RAL 9005	1 pc.
401242	19" blank plate, 1U	stainless steel, blank	1 pc.
401243	19" blank plate, 2U	RAL 7035	1 pc.
401244	19" blank plate, 2U	RAL 9005	1 pc.
401245	19" blank plate, 2U	stainless steel, blank	1 pc.
401247	Cable feedthrough panel with brush strip, 19"/1U	RAL 7035	1 pc.
401248	Cable feedthrough panel with brush strip, 19"/1U	RAL 9005	1 pc.
401249	Cable feedthrough panel with brush strip, 19"/1U	stainless steel, blank	1 pc.
400300	19" cable shelf, depth adjustable due to slide rails (from 520 mm up to 850 mm) (only mountable with a management panel or cable feedthrough panel; rear side 19" fixation necessary)		1 pc.
470038	Labelling strip (for complete management panel with bracket type 1411480)		1 pc.
470039	Labelling strip (for complete management panel with bracket types 1411481 and 1411482)		1 pc.

COPPER ACCESSORIES

Management panels, 19"/1U and 19"/2U assembled with 4 support brackets

 SWISS STANDARD



19"/1U and 19"/2U management panels

PRODUCT INFORMATION

APPLICATION

19" management panels are suitable for the proper routing of copper and fibre optic cables, particularly suitable for patch cords in racks or cabinets with 19" mounting angles and rails.

DESCRIPTION

19"/1U and 19"/2U management panels, assembled with 4 support brackets.

Article No.	Description	Material/Colour	PU
185735	Management panel, 19"/1U, with 4 metal brackets	metal, RAL7035	1 pc.
185736	Management panel, 19"/2U, with 4 metal brackets	metal, RAL7035	1 pc.

Copper

Fibre Optics

Cabinets & Racks

Data Centre

Wireless

Multimedia

General Information

Rangierpanel 1/2HE 0714/e

Cover frames and surface-mount box for Datwyler faceplates / data outlets

 GERMAN STANDARD

Cover frame, 1-fold
80 x 80 mm



Cover frame, 2-fold
150 x 80 mm



Surface-mount box
for data outlets
height = 40 mm



Distance frame for
surface-mount box
height = 10 mm

PRODUCT INFORMATION

APPLICATION

For the surface mounting of Datwyler faceplates / data outlets.

DESCRIPTION

Cover frame, 1-fold and 2-fold

The dimensions of the 1-fold and 2-fold cover frames fully apply with the German standard, that is: outer frame size 80 x 80 mm, inner frame size 50 x 50 mm.

Suitable for the following Datwyler faceplates / outlets:

- Data outlets CSD 2/8-U 2/8 and CSD 2/8-K
- Faceplates 2x and 3x for MS modules
- Faceplates 2x and 3x for MS-K modules
- Faceplate PS-TERA 2x









DESCRIPTION

Surface-mount box for Datwyler faceplates / outlets:

for copper and fibre optic faceplates / outlets.

The surface-mount box (80 x 80 mm) comprises a housing and a cover frame (H = 40 mm).

The distance frame (H = 10 mm) can be used to increase the height from 40 mm to 50 mm.

Article No.		Description	Colour (similar to)	PU
1401630		Cover frame, 1-fold, 80 x 80 x 5 mm	RAL 1013	1 pc.
1400830		Cover frame, 1-fold, 80 x 80 x 5 mm	RAL 9010	1 pc.
1403700		Cover frame, 2-fold	RAL 1013	1 pc.
1403924		Cover frame, 2-fold	RAL 9010	1 pc.
1406274		Surface-mount box, 40 mm, with cover frame	RAL 1013	1 pc.
1406276		Distance frame, 10 mm, for surface-mount box	RAL 1013	1 pc.
1406273		Surface-mount box, 40 mm, with cover frame	RAL 9010	1 pc.
1406275		Distance frame, 10 mm, for surface-mount box	RAL 9010	1 pc.

Mounting support for cable ducts for Datwyler faceplates



Fig.1 Mounting support for horizontal installation without separator



Fig.2 Mounting support for vertical installation without separator

PRODUCT INFORMATION

APPLICATION

Mounting supports for easy and space-saving mounting of Datwyler faceplates in cable ducts in order to maintain the bending radius as required for copper and fibre optic data cables.

Due to Datwyler's extensive range (see below) one can find a mounting support that fits in almost every cable duct system.
Fixing dimension for the faceplates = 60 mm (horizontal).

Suitable for the following Datwyler faceplates:

- Data outlet CSA Plus 2/8
- Faceplate 2x and 3x for MS modules
- Faceplate 2x and 3x for MS-K modules
- Faceplate 1x, 2x and 3x for KS modules
- Faceplate PS-TERA 2x

DESCRIPTION

There are mounting supports to be used for three different installation methods:

- T-Nut fastening horizontal and vertical, suitable for Thealit and Ackermann-k ducts
- DIN rail mounting (35 mm width) 52 mm overall height, suitable for Niedax, Nowa Plast, Rhönmetall, and Rehnau (Signo series) ducts
- DIN rail mounting (35 mm width) 50 mm and 55 mm overall height, suitable for GGK, Licatec, Stago, and Thorsmann Inka series ducts with adapter TTI-N70 or N215

In order to isolate the parts that are connected to the power supply, the supports can also be delivered with a snap-on separator.

Article no.	Fig.	Description	PU
185695	1	Mounting support for faceplate, T-Nut 50 mm, without separator	1 pc. / box
185696	-	Mounting support for faceplate, T-Nut 50 mm, with separator	1 pc. / box
185697	-	Mounting support for faceplate, T-Nut 55 mm, without separator	1 pc. / box
185698	-	Mounting support for faceplate, T-Nut 55 mm, with separator	1 pc. / box
185699	2	Mounting support for faceplate, T-Nut 50 mm, vertical without separator	1 pc. / box
185701	-	Mounting support for faceplate, T-Nut 50 mm, vertical with separator	1 pc. / box
185702	-	Mounting support for faceplate, T-Nut 55 mm, vertical without separator	1 pc. / box
185703	-	Mounting support for faceplate, T-Nut 55 mm, vertical with separator	1 pc. / box
185704	-	Mounting support for faceplate, DIN rail 50 mm, without separator	1 pc. / box
185705	-	Mounting support for faceplate, DIN rail 50 mm, with separator	1 pc. / box
185706	-	Mounting support for faceplate, DIN rail 52 mm, without separator	1 pc. / box
185707	-	Mounting support for faceplate, DIN rail 52 mm, with separator	1 pc. / box
185708	-	Mounting support for faceplate, DIN rail 55 mm, with separator	1 pc. / box
185709	-	Mounting support for faceplate, DIN rail 55 mm, without separator	1 pc. / box

Tools and installation aids for PS-GG45 modules and patch panels



Termination tool for PS-GG45

Patch panel termination aid for
19" racks / cabinets

PRODUCT INFORMATION

DESCRIPTION

Termination tool for Datwyler PS-GG45 modules

For the assembly of the PS-GG45 module and for connecting the wires at the same time.

DESCRIPTION

Termination aid for Datwyler patch panels

The two angular sheets (brackets) can easily be fixed to the 19" frame or cabinet so that the patch panel is presented at an angle of 45 degrees.

The cable termination is much easier and more comfortable with the panel held in this position.

Article No.	Description	PU
400105	Termination tool for PS-GG45 modules	1 pc.
1401624	Patch panel termination aid (1 set = 2 angular sheets)	1 set

COPPER ACCESSORIES

Tools and installation aids

for LSA Plus / IDC termination
for RJ45 Keystone modules



Termination tools
for LSA Plus and IDC contacts



Installation aid for
RJ45 Keystone modules

PRODUCT INFORMATION

DESCRIPTION

Termination tool for LSA Plus or IDC contacts - cable insulation displacement aid

Suitable for the terminating data cables with solid conductors with LSA Plus or IDC contacts. With the help of these tools the cable can be pushed into the contacts, insulated, connected and cut to the requested length.

DESCRIPTION

Installation aid for RJ45 Keystone modules

The installation aid (hand puck) facilitates the connection of a RJ45 Keystone module with the cable conductors and enables optimum protection against injuries.

Article No.	Description	PU
1401609	LSA Plus termination tool for LSA punch down contacts	1 pc.
185896	IDC termination tool 110 (recommended for outlets CSD, patch panels CSP and CUP, and for KS modules)	1 pc.
185898	Keystone Hand Puck, installation aid for RJ45 Keystone modules, red	1 pc.

Tools and installation aids for RJ45 Keystone modules and data cables



Cable connector
Cat. 7 IP20



Anti-dust plug
for RJ45 modules



Anti-dust cover
for RJ45 plug

PRODUCT INFORMATION

DESCRIPTION

Cable connector Cat. 7 IP20

For interconnecting (lengthening) of shielded Cat.5, 6, 6_A, 7 and 7_A data cables.
Shielded metal housing (IP20),
W x L x H: 37 x 114 x 20.5 mm.

DESCRIPTION

Anti-dust plug for RJ45 modules

DESCRIPTION

Anti-dust cover for RJ45 plug

Provides protection against dust and mechanical damage,
fixed to the cable (undetachable),
can be slipped over plugs that are already fitted.

Article No.	Description	PU
417531	Cable connector Cat. 7 IP20	1 pc.
1401628	Anti-dust plug for RJ45 modules	100 pcs.
400305	Anti-dust cover for RJ45 plug	1 pc.

COPPER ACCESSORIES

Tools and installation aids for data cables and for PS / MS modules



PS-TERA/MS tool
for easy cable preparation



Parallel pliers for easy cable termination
(for modules PS-TERA 1/8 and MS 1/8)



Cable stripping tool Abi 62

PRODUCT INFORMATION

DESCRIPTION

PS-TERA/MS tool for cable preparation

To remove the overall sheath of the data cable and the foil around the wire pairs when terminating cables with PS-TERA connectors.
With adjustable block to determine the correct wire lengths.

DESCRIPTION

Parallel pliers for the cable termination with MS 1/8 and PS-TERA 1/8 modules

Pliers for easy cable termination with MS and PS-TERA modules.
Serves as a press-down tool for the modules until they snap into place.

DESCRIPTION

Cable stripping tool Abi 62

The outer sheath and the stabilizing element as well as the screen foil of the data cable CU 6702 4P can be quickly and safely removed with this tool.

Article No.	Description	PU
1412330	Parallel pliers for termination of MS 1/8 and PS-TERA 1/8 modules	1 pc.
1409210	PS-TERA/MS tool for easy cable preparation	1 pc.
185640	Cable stripping tool Abi 62 for CU 6702 4P	1 pc.

Floor box inserts
for RJ45 modules and faceplates

Floor boxes are subfloor connectivity solutions in different shapes and sizes.

As a general rule, the following equipment is used:

- rectangular = GES 9 or GES 6
- round = GESR 9 or GESR 6

They offer the following capacities:

- GES 9 / GESR 9 = max. 3 floor box inserts with 3 ports
- GES 6 / GESR 6 = max. 3 floor box inserts with 2 ports



GES 6 / GES 9

GESR 6 / GESR 9

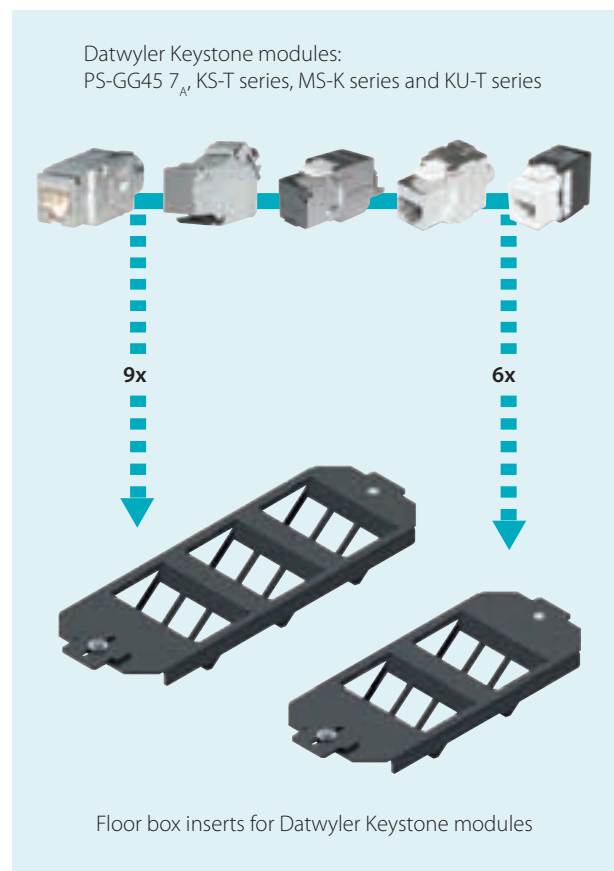
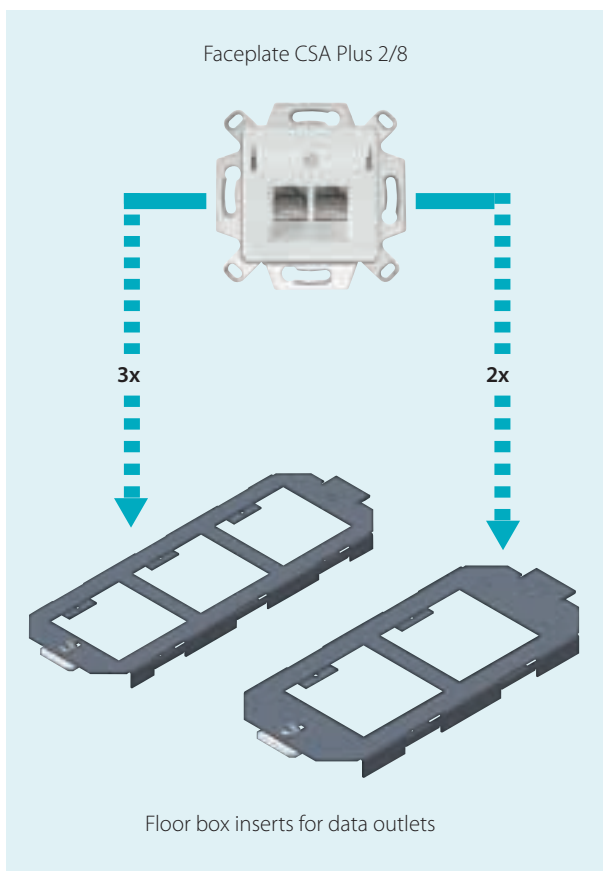

Advantages of floor box inserts and floor box adapter plates

The floor box inserts can be installed in floor boxes from different manufacturers without the need to use mounting boxes. Either data outlets or adapter plates can be installed in the floor box inserts. Adapter plates are available for all types of Datwyler RJ45 modules.

As the floor box inserts can be installed without mounting boxes, this subfloor connectivity solution offers more space and allows for easier subfloor installation of copper and fibre optic cables.

Unused compartments can be closed with blank plates.

CONFIGURATION EXAMPLE



SUBFLOOR SYSTEMS

Floor box inserts for faceplates CSA Plus







Floor box inserts for faceplates CSA Plus



Blank plate

PRODUCT INFORMATION

Floor box solutions

Fig.	Article No.	Description	PU
	417400	Floor box insert for Ackermann GES 9, for 3 faceplates CSA Plus	1 pc.
	417401	Floor box insert for Ackermann GES 6, for 2 faceplates CSA Plus	1 pc.
	417404	Floor box insert for PUK, for 3 faceplates CSA Plus	1 pc.
	417402	Blank plate for floor box inserts Article Nos. 417400 and 417401	1 pc.

Copper

Fibre Optics

Cabinets & Racks

Data Centre

Wireless

Multimedia

General Information

Bodentank-Einsätze für CSA Plus 0714/e

Floor box inserts Economy for Keystone modules MS-K, GG45, KS-T, KU-T

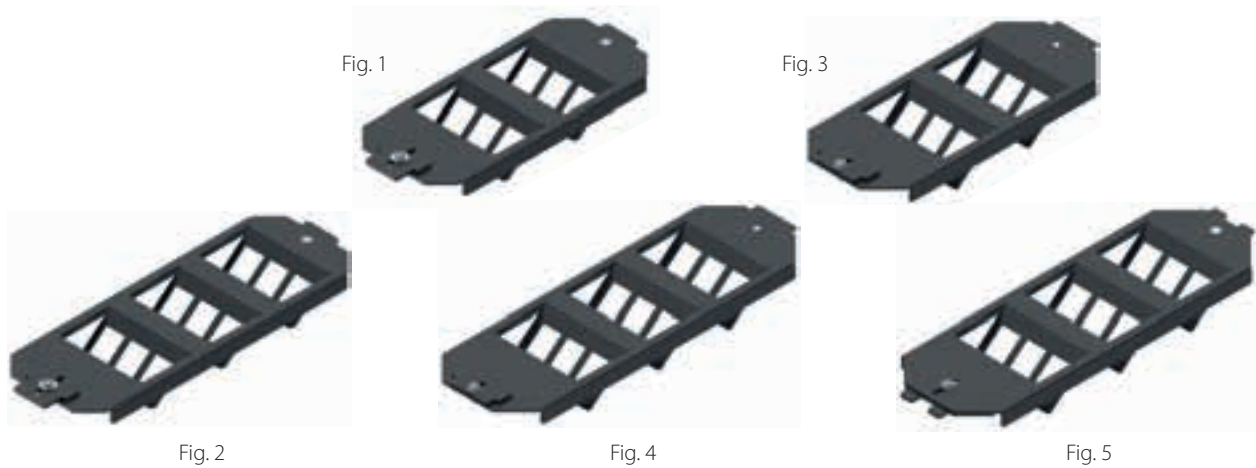

PRODUCT INFORMATION

DESCRIPTION

Floor box inserts Economy for Keystone modules.
Modules can be clipped into the cut-outs directly (without additional adapter plates).
Cut-out (port) dimensions: 14,8 x 19,3 mm.
Suitable for the following Datwyler modules:
PS-GG45 7_A, KS-T series, MS-K series and KU-T series.

Delivery without modules.

Fig.	Article No.	Description	PU
1	418400	Floor box insert Economy for OBO-Ackermann GES6, for 2x 3 Keystone modules	1 pc.
2	418401	Floor box insert Economy for OBO-Ackermann GES9, for 3x 3 Keystone modules	1 pc.
3	418402	Floor box insert Economy for Electraplan, for 2x 3 Keystone modules	1 pc.
4	418403	Floor box insert Economy for Electraplan, for 3x 3 Keystone modules	1 pc.
5	418404	Floor box insert Economy for PUK, for 3x 3 Keystone modules	1 pc.
-	1409559	Blank plate for unused Keystone cut-out (port)	1 pc.

Other floor box solutions available on request

SUBFLOOR SYSTEMS

Consolidation Point box, 12 and 24 ports for one 12-port or 24-port front plate



Box base with mounted 12x MGK front plate
(delivery without front plate)



Consolidation Point box, 12 ports, with cover
and lock (optional)

PRODUCT INFORMATION

APPLICATION For the termination of data cables in a Consolidation Point (CP), typically installed in raised floors.

DESCRIPTION Box accepts one 12-port or 21-port front plate
Two-part construction with box base and cover, both made of galvanised steel sheet
Snap-in cover, can be opened and completely removed from the box base without any tools
Brush strips on front and rear
Protection rating IP20

DIMENSIONS W x H x D: 12 ports: 260 x 55 x 190 mm (with lock: 57 mm)
24 ports: 480 x 55 x 190 mm (with lock: 57 mm)

Front plates need to be ordered separately

FRONT PLATE 12x MGK

Suitable for the following Datwyler modules:

- PS-GG45 7_A 4P shielded
- RJ45 module KS-T Plus 1/8 Cat. 6_A shielded
- RJ45 module MS-K Plus 1/8 Cat. 6_A shielded
- RJ45 module MS-C6_A 1/8 Cat. 6_A 180°-K shielded
- RJ45 module KS-T 1/8 Cat. 6/E_A shielded
- RJ45 module KS-TS 1/8 Cat. 6/E_A shielded
- RJ45 module KU-T 1/8 Cat. 6 / Cat. 5e unshielded

Article No.	Description	Material/Colour	PU
417483	Consolidation Point box, 12 ports (delivery without front plate)	steel sheet, galvanized	1 pc.
417484	Front plate FP 12x MGK for 12-port CP box	steel sheet, galvanized	1 pc.
417489	Consolidation Point box, 24 ports (delivery without front plate)	steel sheet, galvanized	1 pc.
417490	Front plate FP 24x MGK for 24-port CP box	steel sheet, galvanized	1 pc.
417485	Lock for Consolidation Point box, keyed alike	steel sheet, galvanized	1 pc.

Consolidation Point box, 6 ports for one 6-port front plate

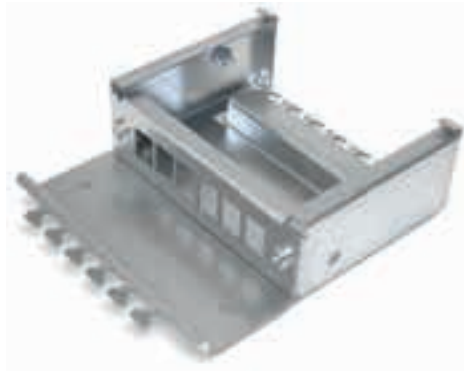

Box base with mounted front plate 6x MGK
(delivery without front plate)



Consolidation Point box, 6 ports,
with cover and lock (optional)

PRODUCT INFORMATION

APPLICATION	For the termination of data cables in a Consolidation Point (CP), typically installed in raised floors.
DESCRIPTION	Box accepts one 6-port front plate Two-part construction with box base and cover, both made of galvanised steel sheet Snap-in cover, can be opened and completely removed from the box base without any tools Brush strips on front and rear Protection rating IP20
DIMENSIONS	W x H x D: 156 x 55 x 190 mm (with lock: H = 57 mm) 6x MGK front plate needs to be ordered separately
FRONT PLATE 6x MGK	<p>Suitable for the following Datwyler modules:</p> <ul style="list-style-type: none"> - PS-GG45 7_A 4P shielded - RJ45 module KS-T Plus 1/8 Cat. 6_A shielded - RJ45 module MS-K Plus 1/8 Cat. 6_A shielded - RJ45 module MS-C6_A 1/8 Cat. 6_A 180°-K shielded - RJ45 module KS-T 1/8 Cat. 6/E_A shielded - RJ45 module KS-TS 1/8 Cat. 6/E_A shielded - RJ45 module KU-T 1/8 Cat. 6 / Cat. 5e unshielded

Article No.	Description	Material/Colour	PU
417487	Consolidation Point box, 6 ports (delivery without front plate)	steel sheet, galvanized	1 pc.
417488	Front plate FP 6x MGK for 6-port CP box	steel sheet, galvanized	1 pc.
417485	Lock for Consolidation Point box, keyed alike	steel sheet, galvanized	1 pc.

Product overview and selection guide for optical fibres

Selection criteria

The Datwyler product portfolio consists of different types of optical fibre.

The following overview lists some of the more important criteria which will help you to decide for the fibre types that meet your specific requirements.

Fibre type	Standard
------------	----------

Single-mode fibres E9/125

Fibre type	Standard	max. attenuation dB/km 850 nm (cabled)	max. attenuation dB/km 1300 /1310 nm (cabled)	max. attenuation dB/km 1383 nm (cabled)	max. attenuation dB/km 1550 nm (cabled)	max. attenuation dB/km 1625 nm (cabled)	max. PMD ps/√km (cabled)	Transmission	Application
SMF E9/125	G.652.D	0.36	0.36	0.23	0.27	0.2		LED 850/1300 nm (typical: 100 Mbit/s)	max. 1 GbE link length 1000Base-SX IEEE 802.3ae (m) max. 10 GbE link length 10GBase-SR/SW IEEE 802.3ae (m)
SMF E9/125, bend insensitive	G.657.A1	0.36	0.36	0.23	0.27	0.2		VCSEL 850 nm (1 GbE - 10 GbE)	
								Laser 1260-1625 (SMF)	Fibre-to-the-desk - horizontal cabling (typical: 1 GbE)
								CWDM- DWDM systems	Campus / Backbone / Data Centre (typical: 10 GbE)
									WAN / National backbone
									City / Metro / Access network
									Fibre-to-the-home

Multimode fibres G50/125

MMF G50/125	OM2	2.70	0.70						750	150								
MMF G50/125	OM3	2.70	0.70						1000	300								
MMF G50/125	OM4	2.70	0.70						1100	550								

Multimode fibre G62,5/125

MMF G62,5/125	OM1	3.00	0.70						275	33								
---------------	-----	------	------	--	--	--	--	--	-----	----	--	--	--	--	--	--	--	--

Checklist: Fibre types, applications and maximum link lengths

Link lengths (m)							
Fibre type		Multimode 50 µm			Multimode 62.5 µm	Single-mode	Single-mode
		OM2	OM3	OM4	OM1	OS2	OS2
Wavelength		850 nm			850 nm	1310 nm	1550 nm
Modal Bandwidth (MHz.km)		500 OFL	2000 EMB	4700 EMB	200 OFL		
Application Standard	Nominal speed						
IEEE 802.3 series Ethernet							
100BASE-SX	1 Gb/s	550 / 750	860 / 1000	860 / 1100	275 / 300	-	-
10GBASE-S	10 Gb/s	82 / 150	300	400 / 550	33	-	-
10GBASE-L	10 Gb/s	-	-	-	-	10000	-
10GBASE-E	10 Gb/s	-	-	-	-	-	30000 / 40000 ²⁾
40GBASE-SR4	40 Gb/s	-	100 / 140	150 ¹⁾ / 170	-	-	-
40GBASE-LR4	40 Gb/s	-	-	-	-	10000	-
100GBASE-SR10	100 Gb/s	-	100 / 140	150 ¹⁾ / 170	-	-	-
100GBASE-LR4	100 Gb/s	-	-	-	-	10000	-
100GBASE-ER4	100 Gb/s	-	-	-	-	30000 / 40000 ²⁾	-
ANSI - INCITS Fibre Channel							
100-MX-SN-I	1 Gb/s	500	860	860	300	-	-
200-MX-SN-I	2 Gb/s	300	500	500	150	-	-
400-MX-SN	4 Gb/s	150	380	400	70	-	-
800-MX-SN	8 Gb/s	50	150	190	21	-	-
800-MX-SA	8 Gb/s	100	300	300	40	-	-
1200-MX-SN-I	10 Gb/s	82	300	450	33	-	-
1600-MX-SN	16 Gb/s	35	100	125	-	-	-
InfiniBand TA³⁾							
IB-1x-SDR-SX	2.5 Gb/s	250	500	500	125	-	-
IB-4x-SDR-SX	10 Gb/s	125	200	200	75	-	-
IB-8x-SDR-SX	20 Gb/s	125	200	200	75	-	-
IB-12x-SDR-SX	30 Gb/s	125	200	200	75	-	-
IB-1x-DDR-SX	5 Gb/s	125	200	200	65	-	-
IB-4x-DDR-SX	20 Gb/s	75	150	150	50	-	-
IB-8x-DDR-SX	40 Gb/s	75	150	150	50	-	-
IB-12x-DDR-SX	60 Gb/s	75	150	150	50	-	-
IB-1x-QDR-SX	10 Gb/s	82	300	300	33	-	-

¹⁾ 1 dB allocated for connection and splice loss

²⁾ 40000 m when using fibres with enhanced values

³⁾ InfiniBand TA specification does not mention OM4 - therefore OM4 is treated as OM3 in this table

The **red** values show maximum link lengths for the Ethernet protocols in the case that optical fibres from Datwyler are used, taking into account less fibre and less connector attenuation than stipulated in the standard.

Single-mode fibre

Application areas for different types of Single-mode fibre

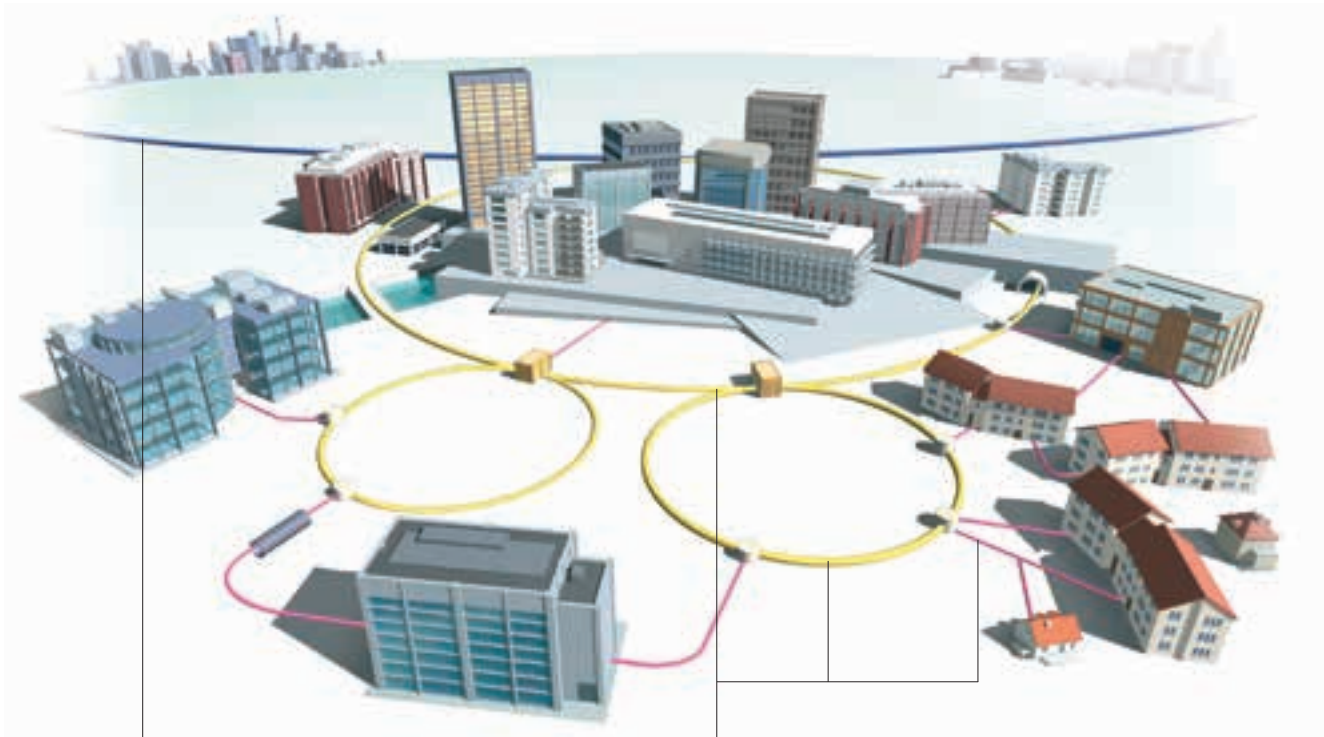

Long Haul / Intercontinental backbones

Single-mode fibres

G.652.D
G.655.D (on request)

City, Access and FTTx networks

Single-mode fibre

G.652.D

Bend insensitive Single-mode fibre

G.657.A1

Criteria for Single-mode fibre selection

Single-mode fibres are the transmission medium of the future. The convergence of telecommunications is a reality, and the demand for network transmission capacity will continue to rise. Datwyler is specifying its single-mode products – focussing on product design for City and Access networks and for Fibre-to-the-Home applications.

Single-mode fibres used by Datwyler provide

- outstanding optical and mechanical properties
- very small polarisation mode dispersion coefficient
- low Water Peak attenuation
- low microbending and low macrobending sensitivity
- highest guarantee of performance delivery to the customer

Bend insensitive Single-mode fibres



For the installation of FTTx networks - including the in-house installation to the local loop - ITU-T defined two single-mode fibre categories, both with two sub-categories that provide different macrobending properties:

ITU-T G.657 Category A

Fibres of this category are compatible with the ITU-T G.652.D fibre, but optimised in terms of reduced macrobending losses (dB) and dimensional specifications. They can be used in the whole FTTx network (access and in-house).

- sub-category ITU-T G.657.A1: suitable for bending radii up to 10 mm
- sub-category ITU-T G.657.A2: suitable for bending radii up to 7.5 mm

ITU-T G.657 Category B

Fibres of this category are compatible with the ITU-T G.657.A and ITU-T G.652.D fibre, but optimised in terms of further reduced macrobending losses (dB). Thus, they are suitable for even smaller bending radii.

They can be used for distances below 1000 m at the end of the FTTx network, particularly in buildings.

- sub-category ITU-T G.657.B3: suitable for bending radii up to 5 mm

Overview: Fibre types and macrobending losses

Bend radius	No. of windings (turns)	G.652.D (1625 nm)	G.657.A1 (1550 nm)	G.657.A2 (1550 nm)	G.657.B3 (1550 nm)
30 mm	100	≤ 0.1 dB	not specified	not specified	not specified
10 mm	1	not specified	≤ 0.75 dB	≤ 0.1 dB	≤ 0.03 dB
7.5 mm	1	not specified	not specified	≤ 0.5 dB	≤ 0.08 dB
5 mm	1	not specified	not specified	not specified	≤ 0.15 dB

Datwyler uses category ITU-T G.657.A1 fibres as standard fibre for the company's FTTx cables. A1 fibres are fully compatible with standard singlemode fibres (ITU-T G.652.D).

Fibre-optic cables with other fibre types are available on request.

Single-mode fibre ITU-T G.652.D

low water peak

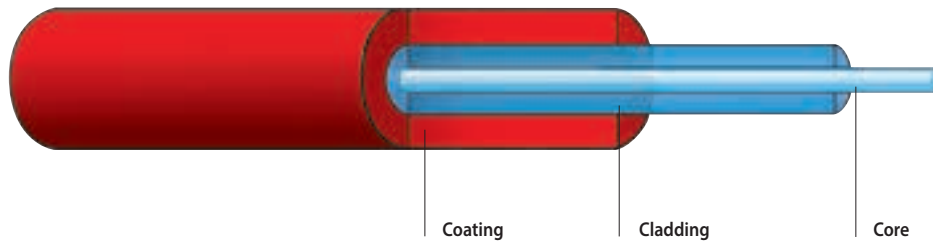

PMD frequency scale of the ITU-T G.652.D fibre

Fibre optic systems with very high bit rates and very low chromatic dispersion must use a singlemode fibre with very low PMD (Polarization Mode Dispersion). The majority of the single-mode fibre G.652.D used by Datwyler provides PMD values that far exceed the limit values stipulated by the standard.

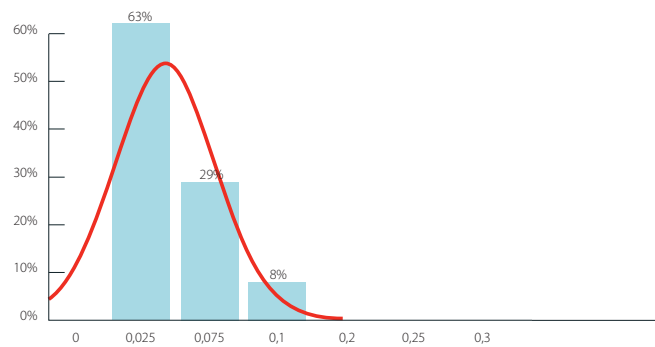

Spectral attenuation of the ITU-T G.652.D fibre

The single-mode fibre G.652.D used by Datwyler is optimised for transmissions of highest data rates at all wavelengths and for all applications. The low water peak attenuation enables CWDM transmissions at the E-Band (1383 nm - 1480 nm). The geometrical, optical and mechanical performance corresponds with the relevant European and international standards.

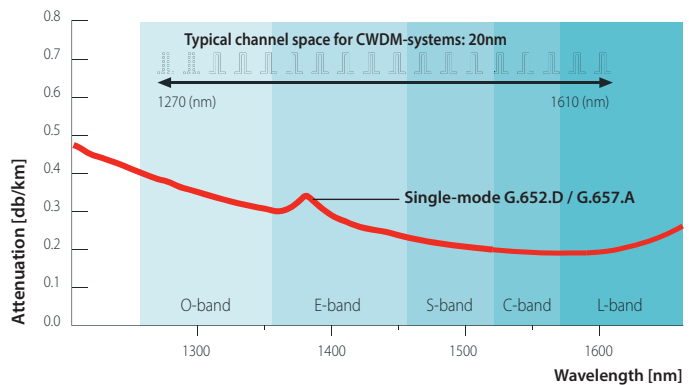

Attenuation of the ITU-T G.652.A-D fibre categories in comparison

	ITU-T G.652.D (OS2)	Datwyler G.652.D (OS2)
Attenuation 1310 nm	≤ 0,4 dB/km	typ. 0,34 dB/km max. 0,36 dB/km
Attenuation 1383 nm	≤ 0,4 dB/km	typ. 0,34 dB/km max. 0,36 dB/km
Attenuation 1550 nm	≤ 0,3 dB/km	typ. 0,22 dB/km max. 0,24 dB/km
Attenuation 1625 nm	≤ 0,4 dB/km	typ. 0,24 dB/km max. 0,25 dB/km
PMD	≤ 0,2 ps/√km	typ. 0,05 ps/√km max. 0,20 ps/√km

Bend insensitive Single-mode fibre E9/125/250

E9/125/250 in accordance with ITU-T G.657.A1
compatible with ITU-T G.652.D

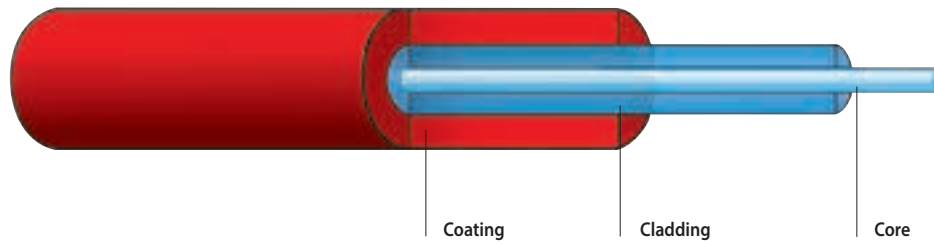

PRODUCT INFORMATION

APPLICATION Home connection, FTTH access network, FTTx in-house cabling.

DESCRIPTION Bend insensitive single-mode fibre with improved macrobending properties for the home connection and for the cabling in FTTH access networks (Fibre-to-the-home). Full-spectrum single-mode fibre, suitable for the operating wavelengths in all FTTx networks. Fully compatible with (and even exceeding) the standards ITU-T G.652.D und ITU-T G.657.A. Permitted bending radius: 15 mm up to 10 mm.

TRANSMISSION CHARACTERISTICS	Wavelength	[nm]	1310	1383	1550	1625
			Maximum attenuation (cabled)	[dB/km]	0.36	0.36*
			* post hydrogen aging performance			
	Maximum Chromatic Dispersion	[ps/(nm x km)]	3.5		18	22
	Zero Dispersion Wavelength λ_0	[nm]	1304 $\leq \lambda_0 \leq$ 1324			
	Maximum Zero Dispersion Slope S_0	[ps/(nm ² x km)]	0.089			
	Mode-Field Diameter	[μ m]	8.6+/- 0.4		9.8+/- 0.5	
	Maximum Cable Cutoff Wavelength λ_{ccf}	[nm]	1260			
	Maximum Polarization Mode Dispersion (PMD)	[ps/ \sqrt km]	0.2		0.2	
	Refractive index		1.4679		1.4684	

GEOMETRICAL AND MECHANICAL CHARACTERISTICS	Cladding diameter		[μ m]	125 +/- 0.7
	Maximum Core / Cladding Concentricity Error		[μ m]	0.5
	Maximum Cladding Non-Circularity		[%]	0.7
	Coating diameter		[μ m]	242 +/- 5
	Maximum Cladding/Coating Concentricity Error		[μ m]	12
	Minimum fibre curl radius		[m]	4.0
	Operating temperature range		[°C]	-60 up to +85
	Test load		[kpsi]	100

MACROBENDING CHARACTERISTICS	Number of windings and bend radius		Wavelength	Max. induced attenuation
	1	turn x 10 mm	1550 nm	\leq 0.50 dB
	1	turn x 10 mm	1625 nm	\leq 1.5 dB
	10	turns x 15 mm	1550 nm	\leq 0.05 dB
	10	turns x 15 mm	1625 nm	\leq 0.3 dB
100	turns x 30 mm	1625 nm	\leq 0.01 dB	

OPTICAL FIBRES

Single-mode fibre E9/125/250

in accordance with ITU-T G.652.D, IEC 60793-2-50 Type B1.3
equates to EN 50173:2011 OS2

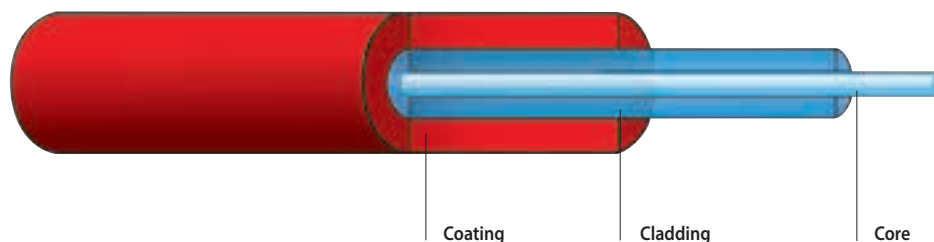

PRODUCT INFORMATION

APPLICATION LAN backbone, data centre, city network, access network, FTTx network, long haul network (WAN).

DESCRIPTION Full-spectrum single-mode fibre in accordance with ITU-T G.652.D with optimised transmission characteristics. Suitable for the operating wavelengths in all FTTx networks. Tight dispersion tolerance to support low-cost upstream transmitters. Superior bending properties allow for easy installation. Backward compatible with installed base of G.652 fibre. Enables a cost-effective FTTx deployment: provides extra distance and margin and reduces field equipment and maintenance costs.

TRANSMISSION CHARACTERISTICS	Wavelength	[nm]	1310	1383	1550	1625
			Maximum attenuation (cabled)	[dB/km]	0.36	0.36*
				*post hydrogen aging performance		
	Maximum Chromatic Dispersion	[ps/(nm x km)]	3.5		18	23
	Zero Dispersion Wavelength λ_0	[nm]	1304 $\leq \lambda_0 \leq$ 1324			
	Maximum Zero Dispersion Slope S_0	[ps/(nm ² x km)]	0.092			
	Mode-Field Diameter	[μ m]	9.2 +/- 0.4	10.4 +/- 0.5		
	Maximum Cable Cut-off Wavelength λ_{ccf}	[nm]	1260			
	Polarisation Mode Dispersion (PMD),					
	Maximum PMDq Link Design Value (cabled)	[ps/ \sqrt km]	0.1		0.1	
	Refractive Index		1.4676		1.4682	

GEOMETRICAL AND MECHANICAL CHARACTERISTICS	Cladding diameter	[μ m]	125.0 +/- 0.7
	Maximum Core/Cladding Concentricity Error	[μ m]	0.5
	Maximum Cladding Non-Circularity	[%]	0.7
	Coating diameter	[μ m]	245 +/- 5
	Maximum Cladding/Coating Concentricity Error	[μ m]	12
	Minimum fibre curl radius	[m]	4.0
	Operating temperature range	[$^{\circ}$ C]	-60 to +85
	Test load	[kpsi]	100

Multimode and single-mode fibres

Application areas for different types of Multimode and Single-mode fibres

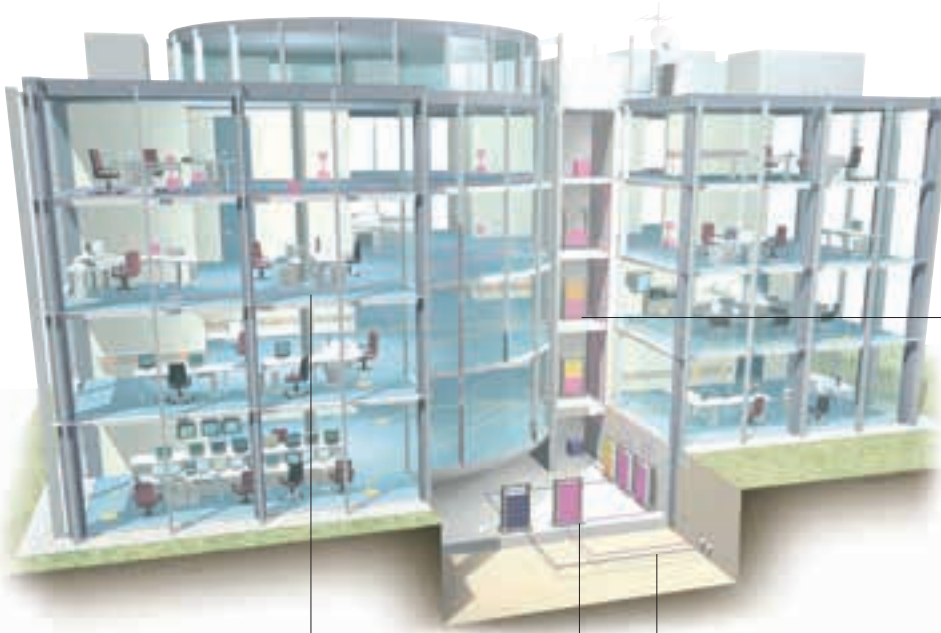
**Horizontal**

FTTD Fibre to the Desk
FTTO Fibre to the Office

Multimode fibre

G50/125 OM2
1 GbE up to 750 m
10 GbE up to 150 m

G50/125 OM3
1 GbE up to 1000 m
10 GbE up to 300 m

Data Centre**Multimode fibre**

G50/125 OM3
10 GbE up to 500 m
40/100 GbE up to 140 m

G50/125 OM4
10 GbE up to 550 m
40/100 GbE up to 170 m

Single-mode fibre

E9/125 G.652.D OS2

Vertical/Riser (backbone)**Multimode fibre**

G50/125 OM3
10 GbE up to 300 m

G50/125 OM4
10 GbE up to 550 m

Single-mode fibre

E9/125 G.652.D OS2

Campus (backbone)**Multimode fibre**

G50/125 OM3
10 GbE up to 300 m

G50/125 OM4
10 GbE up to 550 m

Single-mode fibre

E9/125 G.652.D OS2
10 GbE up to 10 km

Bend insensitive Multimode fibres (G50/125 µm)

With higher bit-rate transmissions (≥ 10 Gbit/s), the attenuation budgets are constantly decreasing. Thus, one has to focus on high-grade products when selecting the fibre optic components. The optical fibres should provide an enhanced transmission reliability and reduce the risks of additional losses that may arise as a result of typical faulty use and of mechanical stress.

This is the reason why Datwyler uses the bend insensitive G50/125µm fibre for OM2, OM3 and OM4 fibre categories: In case that the minimum bending radius is undercut, this leads not necessarily to failure of a connection. However, too small bending radii should be avoided to extend the lifetime of fibre optic cables (and optical fibres).

The bend insensitive G50/125 µm fibres are fully compatible with "traditional" G50/125 µm fibres as described in the standard.

Bend radius (mm)	No. of windings (turns)	Maximum induced bend attenuation (dB)	
		850 nm	1300 nm
37.5	100	≤ 0.5	≤ 0.5
15	2	≤ 0.1	≤ 0.3
7.5	2	≤ 0.2	≤ 0.5

OPTICAL FIBRES

Multimode fibre G62,5/125/250 OM1

IEC 60793-2-10 Type A1b, ISO/IEC 11801:2010 OM1, EN 50173:2011 OM1

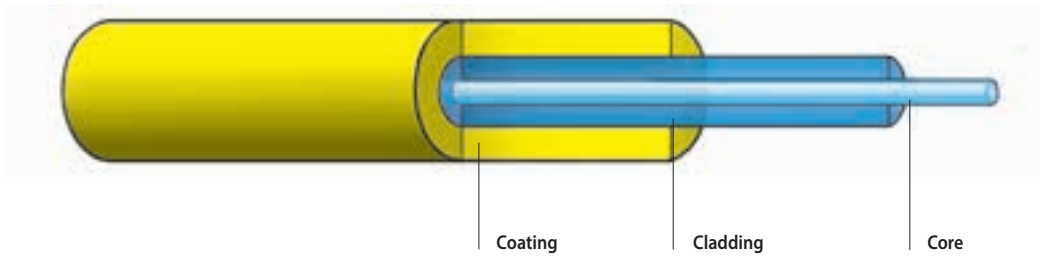

PRODUCT INFORMATION

APPLICATION In premises cabling, e.g. for Fibre to the Desk (FTTD), primarily in existing/legacy installations.

DESCRIPTION Suitable for short transmission distances and medium transmission rates in the 850 nm and 1300 nm wavelengths (typically up to 1 GbE). The geometrical and mechanical characteristics meet all relevant international standards.

TRANSMISSION CHARACTERISTICS	Wavelength	[nm]	850	1300
	Attenuation typical (cabled)	[dB/km]		2.8
Attenuation maximum (cabled)	[dB/km]		3.0	0.7
OFL bandwidth as per TIA/EIA 455-204 and IEC 60793-1-41	[MHz x km]		200	600
RML bandwidth as per TIA/EIA 455-204 and IEC 60793-1-41	[MHz x km]		220	
Refractive Index			1.496	1.491

GEOMETRICAL AND MECHANICAL CHARACTERISTICS	Numerical Aperture		0.275 +/- 0.015
	Core Ø	[µm]	62.5 +/- 2.5
	Maximum Core Non-Circularity	[%]	5
	Cladding Ø	[µm]	125 +/- 2
	Maximum Cladding Non-Circularity	[%]	1.0
	Maximum Cladding/Core Concentricity Error	[µm]	1.5
	Maximum Coating Concentricity Error	[µm]	12
	Coating Ø	[µm]	245 +/- 5
	Test load	[kpsi]	100

MAXIMUM LINK LENGTHS

IEEE 802.3 Serie	Wavelength [nm]	Link length [m]	Explanation
1000 Base-SX IEEE 802.3z	850	275 / 300*	Laser bandwidth RML (Restricted Mode Launch) measurement is used to characterise intermediate performance laser (typically up to 1 GbE) at 850 nm.
1000 Base-LX IEEE 802.3z	1300	550	
10GBase-SR/SW	850	33	Link length is achieved via 1300 nm "CWDM" using 4 channels (lanes) at 2.25 GbE: Lane 0 = 1269.0 - 1282.4 nm, Lane 1 = 1293.5 - 1306.9 nm Lane 2 = 1318.0 - 1331.4 nm, Lane 3 = 1342.5 - 1355.9 nm
10GBase-LX4	1300	300	

* Link lengths of more than 300 m on request.

MMF, OM1 1108/e

Copper
Fibre Optics
Cabinets & Racks
Data Centre
Wireless
Multimedia
General Information

Bend insensitive**Multimode fibre G50/125/250 OM2**

IEC 60793-2-10 Type A1a.1, ISO/IEC 11801:2010 OM2,

EN 50173:2011 OM2

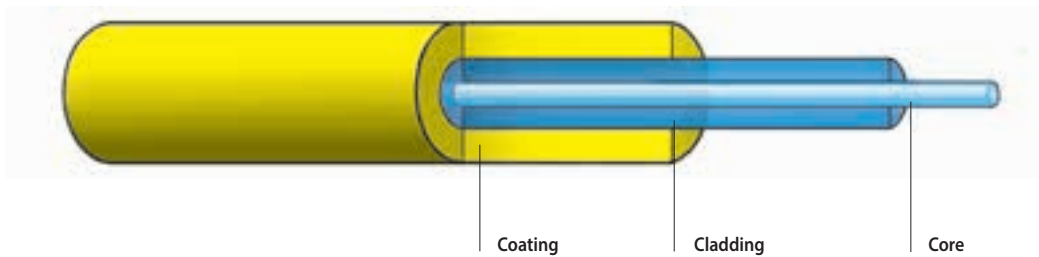

PRODUCT INFORMATION

APPLICATION	In Premises cabling for Vertical/Riser cabling and for Fibre to the Desk (FTTD = horizontal cabling).
DESCRIPTION	Bend insensitive fibre with enhanced macrobending features, suitable for medium transmission distances and medium transmission rates in the 850 nm and 1300 nm wavelengths (up to 1 GbE). The geometrical, optical and mechanical specifications meet or exceed all relevant international standards.

TRANSMISSION CHARACTERISTICS	Wavelength	[nm]	Product parameters		Standard spec.	
			850	1300	850	1300
	Attenuation typical (cabled)	[dB/km]	2.5	0.5		
	Attenuation maximum (cabled)	[dB/km]	2.7	0.7	3.5	1.5
	OFL bandwidth per TIA/EIA 455-204 and IEC 60793-1-41	[MHz x km]	700	500	500	500
	High-performance EMB bandwidth as per TIA/EIA 455-220A and IEC 60793-1-49	[MHz x km]	850		not specified	
	Refractive Index		1.480	1.479		
GEOMETRICAL AND MECHANICAL CHARACTERISTICS	Numerical Aperture		0.200 +/- 0.015			
	Core Ø	[µm]	50.0 +/- 2.5			
	Maximum Core Non-Circularity	[%]	5			
	Cladding Ø	[µm]	125.0 +/- 1.0			
	Maximum Cladding Non-Circularity	[%]	1.0			
	Maximum Cladding/Core Concentricity Error	[µm]	1.5			
	Maximum Coating Concentricity Error	[µm]	12			
	Coating Ø	[µm]	245 +/- 5			
Test load	[kpsi]	100				

MACROBENDING CHARACTERISTICS	Bending radius [mm]	No. of windings (turns)	Maximum induced attenuation [dB]	
			850 nm	1300 nm
	37.5	100	≤ 0.05	≤ 0.15
	15	2	≤ 0.1	≤ 0.3
	7.5	2	≤ 0.2	≤ 0.5

MAXIMUM LINK LENGTHS

IEEE 802.3 series	Wavelength [nm]	Max. link length Datwyler [m]	Link length Standard [m]	Explanation
1000 Base-SX IEEE 802.3z	850	750	550	High-performance laser bandwidth EMB: Datwyler guarantees the EMB bandwidth through the calculated Effective Modal Bandwidth (mEMBc). This is a DMD based method to characterise laser bandwidth over the full range of standard compliant high-performance 850 nm VCSEL lasers. This measurement method is used to inspect the laser system for high data rates (up to 100 Gbit/s) in the 850 nm wavelength.
1000 Base-LX IEEE 802.3z	1300	550	550	
10GBase-SR/SW IEEE 802.3ae	850	150	82	
10GBase-LX4	1300	300	300	Link length is achieved via 1300nm „CWDM“ using 4 channels (lanes): Lane 0 = 1269,0 – 1282,4 nm, Lane 1 = 1293,5 – 1306,9 nm, Lane 2 = 1318,0 – 1331,4 nm, Lane 3 = 1342,5 – 1355,9 nm

OPTICAL FIBRES

**Bend insensitive
Multimode fibre G50/125/250 OM3**

IEC 60793-2-10 Type A1a.2, ISO/IEC 11801:2010 OM3,
EN 50173:2011 OM3, TIA/EIA 492AAAC-B

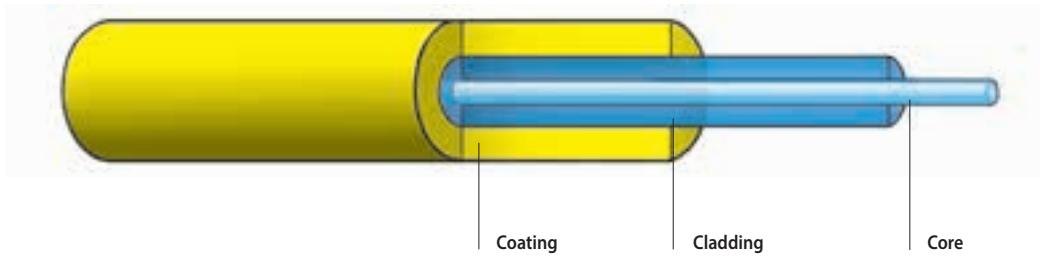

PRODUCT INFORMATION

APPLICATION

In Premises cabling for LAN backbones (Campus and Vertical/Riser cabling), Fibre to the Office and Fibre to the Desk (FTTO, FTTD = horizontal cabling) as well as in Data Centre cabling.

DESCRIPTION

Bend insensitive fibre with enhanced macrobending features, particularly recommended for high-performance transmissions in the 850 nm wavelength like 10-GbE with duplex links or 40/100-GbE with high-speed parallel optic links. The geometrical, optical and mechanical specifications meet or exceed all relevant international standards. This fibre is compatible with standard category OM2 fibres in existing/legacy networks.

TRANSMISSION CHARACTERISTICS	Wavelength [nm]	Product parameters		Standard spec.	
		850	1300	850	1300
Attenuation typical (cabled)	[dB/km]	2.5	0.5		
Attenuation maximum (cabled)	[dB/km]	2.7	0.7	3.5	1.5
OFL Bandwidth as per TIA/EIA 455-204 and IEC 60793-1-41	[MHz x km]	1500	500	1500	500
High-performance EMB bandwidth as per TIA/EIA 455-220A and IEC 60793-1-49	[MHz x km]	2000		2000	
Refractive Index		1.480	1.479		
GEOMETRICAL AND MECHANICAL CHARACTERISTICS					
Numerical Aperture		0.200 +/- 0.015			
Core Ø	[µm]	50.0 +/- 2.5			
Maximum Core Non-Circularity	[%]	5			
Cladding Ø	[µm]	125.0 +/- 1.0			
Maximum Cladding Non-Circularity	[%]	1.0			
Maximum Cladding/Core Concentricity Error	[µm]	1.5			
Maximum Coating Concentricity Error	[µm]	12			
Coating Ø	[µm]	242 +/- 5			
Test load	[kpsi]	100			

MACROBENDING CHARACTERISTICS	Bending radius [mm]	No. of windings turns	Maximum induced attenuation [dB]	
			850 nm	1300 nm
	37.5	100	≤ 0.05	≤ 0.15
	15	2	≤ 0.1	≤ 0.3
	7.5	2	≤ 0.2	≤ 0.5

MAXIMUM LINK LENGTHS

IEEE 802.3 series	Wavelength [nm]	Link length Datwyler [m]	Link length Standard [m]	Explanation
1000 Base-SX IEEE 802.3z	850	1000	800	High-performance laser bandwidth EMB: Datwyler guarantees the EMB bandwidth through the calculated Effective Modal Bandwidth (mEMBc). This is a DMD based method to characterise laser bandwidth over the full range of standard compliant high-performance 850 nm VCSEL lasers.
10GBase-SR/SW IEEE 802.3ae	850	300	300	This measurement method is used to inspect the laser system for high data rates up to 100 Gbit/s in the 850 nm wavelength.
40GBase-SR4 IEEE 802.3ba	850	140*	100	
100GBase-SR10 IEEE 802.3ba	850	140*	100	*The enhanced link length is a result of an enhanced dispersion value. The Insertion Loss (IL) of all connectors in the optical channel should not exceed 1.0 dB! (Standard: 1.5 dB)

MMF, OM3 biageoptimiert 0712/e

Bend insensitive Multimode fibre G50/125/250 OM4

IEC 60793-2-10 Type A1a.3, ISO/IEC 11801:2010 OM4,
EN 50173:2011 OM4, TIA/EIA 492AAAD

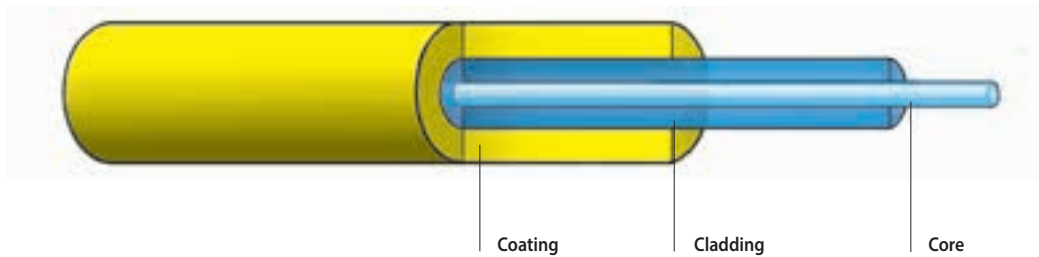

PRODUCT INFORMATION

APPLICATION	In Premises cabling for LAN backbones (Campus and Vertical/Riser cabling) as well as in Data Centres.
DESCRIPTION	Bend insensitive fibre with enhanced macrobending features, particularly recommended for high-performance transmissions in the 850 nm wavelength like 10-GbE with duplex links or 40/100-GbE with high-speed parallel optic links. The geometrical, optical and mechanical specifications meet or exceed all relevant international standards.

TRANSMISSION CHARACTERISTICS	Wavelength [nm]	Product parameters		Standard spec.	
		850	1300	850	1300
Attenuation typical (cabled)	[dB/km]	2.5	0.5		
Attenuation maximum (cabled)	[dB/km]	2.7	0.7	3.5	1.5
OFL bandwidth as per TIA/EIA 455-204 and IEC 60793-1-41	[MHz x km]	3500	500	3500	500
High-performance EMB bandwidth as per TIA/EIA 455-220A and IEC 60793-1-49	[MHz x km]	4700		4700	
Refractive Index		1.480	1.479		
GEOMETRICAL AND MECHANICAL CHARACTERISTICS	Numerical Aperture	0.200 +/- 0.015			
	Core Ø [µm]	50.0 +/- 2.5			
	Maximum Core Non-Circularity [%]	5			
	Cladding Ø [µm]	125.0 +/- 1.0			
	Maximum Cladding Non-Circularity [%]	1.0			
	Maximum Cladding/Core Concentricity Error [µm]	1.5			
	Maximum Coating Concentricity Error [µm]	12			
	Coating Ø [µm]	242 +/- 5			
	Test load [kpsi]	100			

MACROBENDING CHARACTERISTICS	Bending radius [mm]	No. of windings (turns)	Maximum induced attenuation [dB]	
			850 nm	1300 nm
	37.5	100	≤ 0.05	≤ 0.15
	15	2	≤ 0.1	≤ 0.3
	7.5	2	≤ 0.2	≤ 0.5

MAXIMUM LINK LENGTHS

IEEE 802.3 series	Wavelength [nm]	Link length Datwyler [m]	Link length Standard [m]	Explanation
1000 Base-SX IEEE 802.3z	850	1100	800	High-performance laser bandwidth EMB: Datwyler guarantees the EMB bandwidth through the calculated Effective Modal Bandwidth (mEMBc). This is a DMD based method to characterise laser bandwidth over the full range of standard compliant high-performance 850 nm VCSEL lasers.
10GBase-SR/SW IEEE 802.3ae	850	550	550	This measurement method is used to inspect the laser system for high data rates (up to 100 Gbit/s) in the 850 nm wavelength.
40GBase-SR4 IEEE 802.3ba	850	170*	150	
100GBase-SR10 IEEE 802.3ba	850	170*	150	*The enhanced link length is a result of an enhanced dispersion value. The Insertion Loss (IL) of all connectors in the optical channel should not exceed 1.0 dB! (Standard: 1.5 dB)

FIBRE OPTIC CABLES - PRODUCT OVERVIEW

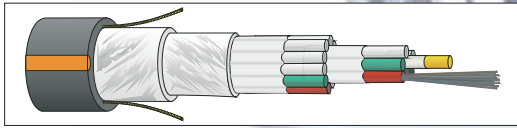

FO Outdoor wbGGT HP / A-DQ(ZN)B2Y
HighP, up to 576 fibres

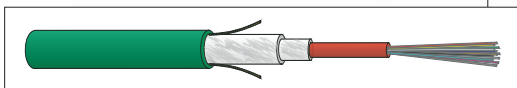

FO Universal ZGGFR / U-DQ(ZN)BH
Flame retardant fibre optic cable for indoor and outdoor use, up to 24 fibres

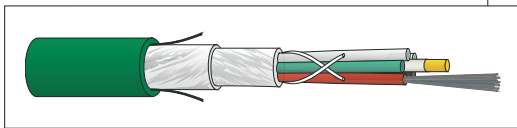

FO Universal wbGGFR / U-DQ(ZN)BH
Flame retardant fibre optic cable for indoor and outdoor use, up to 144 fibres

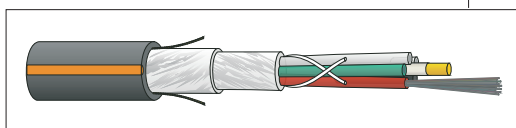

FO Universal wbGGFR Easy Blow / U-DQ(ZN)BH
Flame retardant fibre optic cable for indoor and outdoor use, up to 288 fibres, optimised for air injection

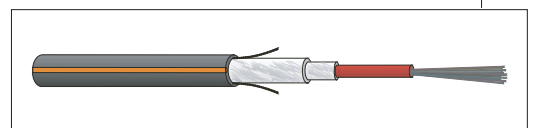

FO Outdoor ZGGT HP / A-DQ(ZN)B2Y
HighP, up to 24 fibres

Copper

Fibre Optics

Cabinets & Racks

Data Centre

Wireless

Multimedia

General Information

Please find detail overviews and selection guides
for FO indoor and universal cables on page 196
and for FO outdoor cables on page 219

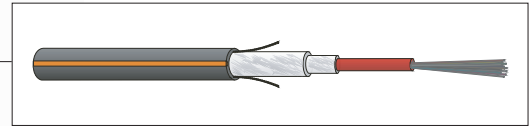
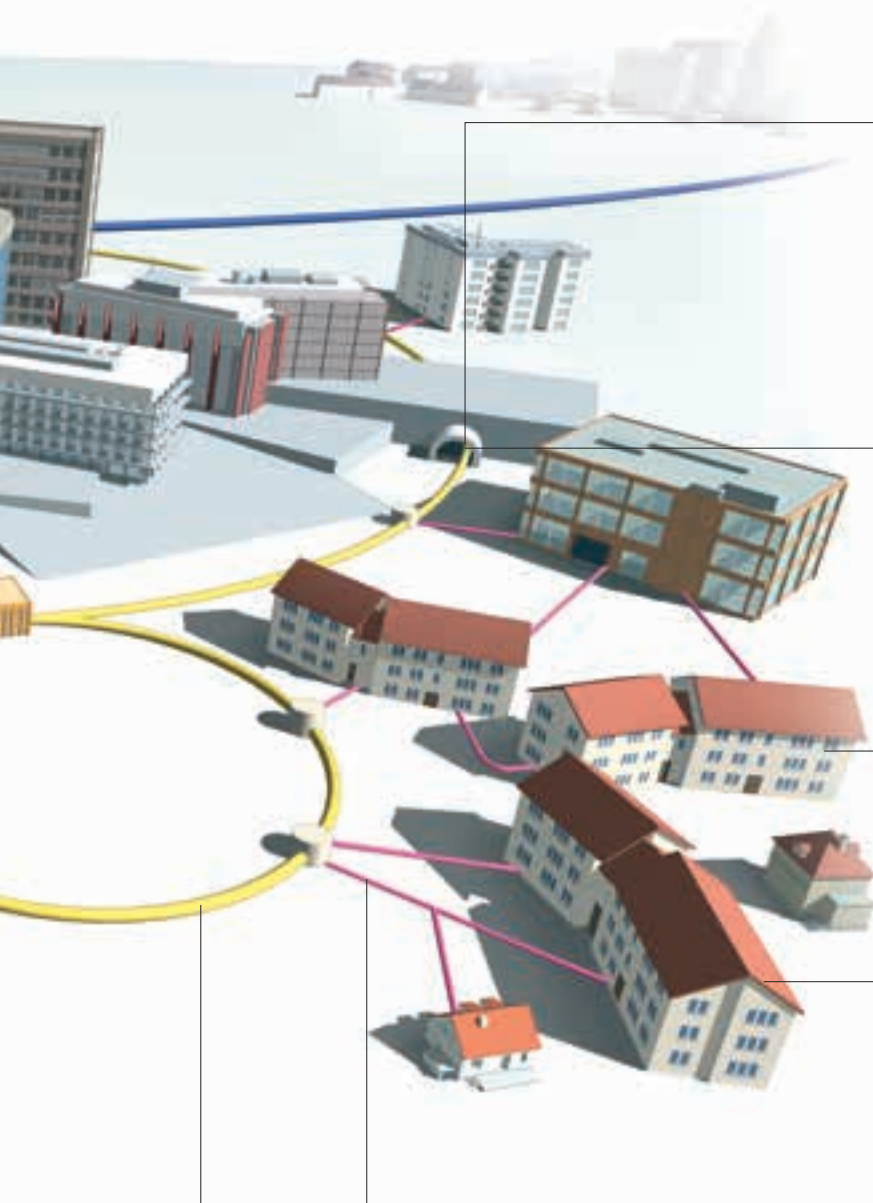

FO Outdoor ZGGT HP / A-DQ(ZN)B2Y
HighP, up to 24 fibres

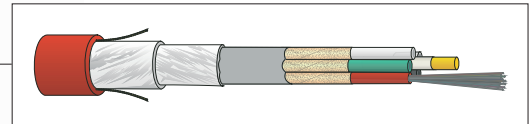

FO Universal wbGGFR Safety / U-DQ(ZN)BH
Safety cable, 30 mins. circuit integrity, up to 60 fibres

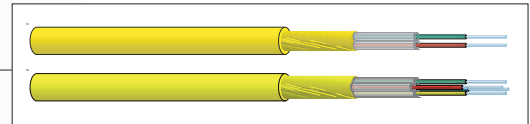

FO Indoor FTTH STB/ I-V(ZN)H
Semi tight buffer, 2 or 4 fibres

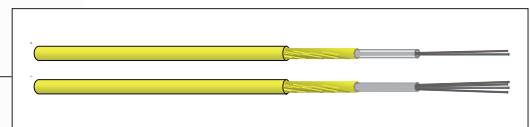

FO Indoor FTTH / I-M(ZN)H
Coating buffer, 2 or 4 fibres

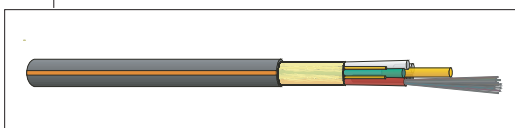

FO Outdoor wbKT Micro / A-DQ(ZN)2Y
Micro cable, up to 144 fibres

FO Outdoor wbKT S-Micro / A-DQ(ZN)2Y
High-density micro cable, up to 216 fibres

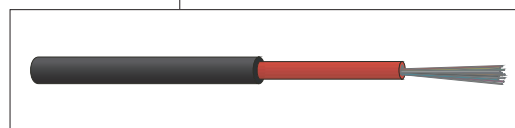

FO Outdoor ZT S-Micro / A-D2Y
High-density micro cable, up to 24 fibres

Product overview and selection guide for FO indoor and universal cables

Selection criteria

The Datwyler product portfolio consists of many different cable types.

The following overview lists some of the more important criteria which will help you to decide for the cable types that meet your specific requirements.

Cable name Datwyler / DIN VDE page

				Cable characteristics										Laying		Application								
				Maximum number of fibres	Rodent protection	Non-metallic (no potential differences)	Longitudinal water blocking	Halogen-free sheath	Flame retardant sheath	Functional integrity / Circuit integrity 30 min.	Loose tube	Semi Tight Buffer	Coating buffer design	Tight buffer tube design 0.9 mm	Tight buffer tube design 0.6 mm	Blowing through thermoplastic ducts	Installation in vertical / riser zone	Laying in trays and on cable platforms	Tunnels / Safety areas	Campus / Access networks	LAN: backbone	LAN: Fibre to the desk (FTTD)	LAN: Patch area	
Fibre optic indoor cables																								
FO Indoor Simplex / I-V(ZN)H	2.0 mm / 2.8 mm, LS0H	197	1	●	●	●	●	●	●	●	●	●	●	●	●	●	●	●	●	●	●	●	●	●
FO Indoor Mini Zipcord / I-V(ZN)H	1.8 mm, LS0H	198	2	●	●	●	●	●	●	●	●	●	●	●	●	●	●	●	●	●	●	●	●	●
FO Indoor Zipcord / I-V(ZN)H	2.0 mm / 2.8 mm, LS0H	199	2	●	●	●	●	●	●	●	●	●	●	●	●	●	●	●	●	●	●	●	●	●
FO Indoor Duplex / I-V(ZN)HH	2.0 mm / 2.8 mm, LS0H	200	2	●	●	●	●	●	●	●	●	●	●	●	●	●	●	●	●	●	●	●	●	●
FO Indoor FTTH / I-M(ZN)H	2.2 mm, LS0H	202	4	●	●	●	●	●	●	●	●	●	●	●	●	●	●	●	●	●	●	●	●	●
FO Indoor FTTH STB / I-V(ZN)H	2.8 mm, LS0H	203	4	●	●	●	●	●	●	●	●	●	●	●	●	●	●	●	●	●	●	●	●	●
FO Indoor BO / I-V(ZN)HH	Breakout, 2.0 mm, FR/LS0H	204	12	●	●	●	●	●	●	●	●	●	●	●	●	●	●	●	●	●	●	●	●	●
Fibre optic universal cables																								
FO Universal ZGGFR / U-DQ(ZN)BH	up to 24 fibres	206	24	●	●	●	●	●	●	●	●	●	●	●	●	●	●	●	●	●	●	●	●	●
FO Universal wbGGFR / U-DQ(ZN)BH	up to 144 fibres	208	144	●	●	●	●	●	●	●	●	●	●	●	●	●	●	●	●	●	●	●	●	●
FO Universal ZGGFR Safety / U-DQ(ZN)BH	Safety cable E30	210	12	●	●	●	●	●	●	●	●	●	●	●	●	●	●	●	●	●	●	●	●	●
FO Universal wbGGFR Safety / U-DQ(ZN)BH	Safety cable E30	212	60	●	●	●	●	●	●	●	●	●	●	●	●	●	●	●	●	●	●	●	●	●
FO Universal ZGGFR Easy Blow / U-DQ(ZN)BH		214	24	●	●	●	●	●	●	●	●	●	●	●	●	●	●	●	●	●	●	●	●	●
FO Universal wbGGFR Easy Blow / U-DQ(ZN)BH		216	288	●	●	●	●	●	●	●	●	●	●	●	●	●	●	●	●	●	●	●	●	●
FO Universal wbGGFR Combi / U-DQS(ZN)BH	Combination cable	218	2	●	●	●	●	●	●	●	●	●	●	●	●	●	●	●	●	●	●	●	●	●

Copper

Fibre Optics

Cabinets & Racks

Data Centre

Wireless

Multimedia

General Information

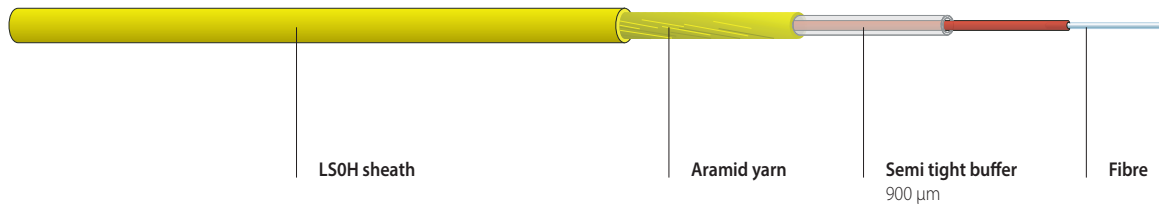

PRODUCT INFORMATION



FEATURES

Thin and flexible fibre optic Simplex cable with semi-tight buffer 0.9 mm.
 Easy handling, easy to strip off.
 Flame retardant halogen-free LSOH sheath. Low fire load.

APPLICATION

Suitable for patch cables between terminal distributors and/or end devices.
 For direct termination with connectors.
 Can also be spliced in terminal distributors.

OPTICAL CHARACTERISTICS

The cables are available with different types of optical fibre (see fibre data sheets).

MECHANICAL CHARACTERISTICS

Temperature range in operation: -20 / +60°C IEC 60794-2-10
 -10 / +60°C for assembled patch cords
 Tensile performance: IEC 60794-1-2 E1 A
 Crush resistance: IEC 60794-1-2 E3
 Impact: IEC 60794-1-2 E4
 Repeated bending: IEC 60794-1-2 E6
 Torsion: IEC 60794-1-2 E7
 Bend: IEC 60794-1-2 E11 A

GENERAL CHARACTERISTICS

Sheath colour: E9/125 yellow or green
 G50/125 OM2 orange
 G50/125 OM3 turquoise
 G50/125 OM4 heather violet
 G62.5/125 OM1 grey
 Imprint: DATWYLER «cable type» «Datwyler designation» «DIN designation»
 «no. of fibres» «fibre type» «add. text» «batch no.» «meter marks»
 Zero halogen, non corrosive gases IEC 60754-1/-2, EN 50267-2-1/-2-2, VDE 0482-267-2-1/-2-2
 Flame retardant IEC 60332-1-2, EN 60332-1-2, VDE 0482-332-1-2
 Minimum smoke emission IEC 61034-1/-2, EN 61034-1/-2 (EN 50268-1/-2), VDE 0482-1034-1/-2 (VDE 0482-268-1/-2)

Description	Sheath Ø	Weight	Bending radius	Tensile load	Crush resistance	Fire load
I-V(ZN)H	mm	kg/km	mm	N	short term N	kWh/km MJ/km
EF 2.0 Simplex	2.0	4.1	50	100	500	31 111
EF 2.8 Simplex	2.8	7.1	70	100	500	35 124

VERSIONS

I-V(ZN)H	Fibres	Article No.	Article No.	Article No.	Article No.	Article No.	Article No.	Article No.
Description	number	E9/125 G.657.A1	E9/125 G.652.D	E9/125 G.652.D	G50/125 OM2	G50/125 OM3	G50/125 OM4	G62.5/125 OM1
Sheath colour		yellow	green	yellow				
EF 2.0 Simplex	1	192126	-	-	191877	191878	on request	-
EF 2.8 Simplex	1	193341	192085	192086	192087	192088	on request	192089

FO Indoor Mini Zipcord / I-V(ZN)H

1.8 mm, LSOH

Tight buffer

flame retardant - IEC 60332.1

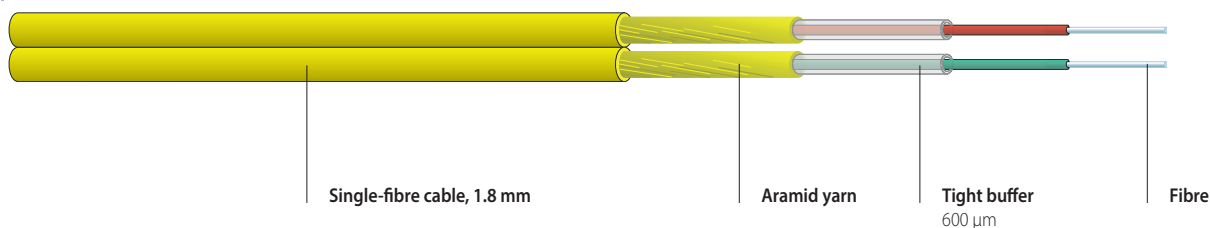

PRODUCT INFORMATION



FEATURES

Very thin and flexible Mini Zipcord with tight buffers 0.6 mm.
The ends can easily be split into two single cables.
Flame retardant halogen-free LSOH sheath.
Very low fire load.

APPLICATION

Suitable for patch cables between terminal distributors and/or end devices.
For direct termination with Simplex or Duplex connectors.

OPTICAL CHARACTERISTICS

The cables are available with different types of optical fibre (see fibre data sheets).

MECHANICAL CHARACTERISTICS

Temperature range in operation: -20 / +60°C IEC 60794-2-10
-10 / +60°C for assembled patch cords

Tensile performance: IEC 60794-1-2 E1 A
Crush resistance: IEC 60794-1-2 E3
Impact: IEC 60794-1-2 E4
Repeated bending: IEC 60794-1-2 E6
Torsion: IEC 60794-1-2 E7
Bend: IEC 60794-1-2 E11 A

GENERAL CHARACTERISTICS

Sheath colour: E9/125 yellow or green
G50/125 OM2 orange
G50/125 OM3 turquoise
G50/125 OM4 heather violet
G62.5/125 OM1 grey

Imprint: DATWYLER «cable type» «Datwyler designation» «DIN designation»
«no. of fibres» «fibre type» «add. text» «batch no.» «meter marks»

Zero halogen, non corrosive gases IEC 60754-1/-2, EN 50267-2-1/-2-2, VDE 0482-267-2-1/-2-2
 Flame retardant IEC 60332-1-2, EN 60332-1-2, VDE 0482-332-1-2
 Minimum smoke emission IEC 61034-1/-2, EN 61034-1/-2 (EN 50268-1/-2), VDE 0482-1034-1/-2 (VDE 0482-268-1/-2)

Description	Sheath Ø	Weight	Bending radius	Tensile load	Crush resistance	Fire load
I-V(ZN)H	mm	kg/km	mm	N	short term N	kWh/km MJ/km
Mini Zipcord 1.8	3.7 x 1.8	4.8	50	150	800	52 187

VERSIONS

I-V(ZN)H	Fibres	Article No.	Article No.	Article No.	Article No.	Article No.	Article No.	Article No.
Description	number	E9/125 G.652.D	E9/125 G.652.D	E9/125 G.657.A2	G50/125 OM2	G50/125 OM3	G50/125 OM4	G62.5/125 OM1
Sheath colour		green	yellow	yellow	orange	turquoise	heather violet	grey
Mini Zipcord 1.8	2	190247	190306	193465	186367	186038	193468	186368

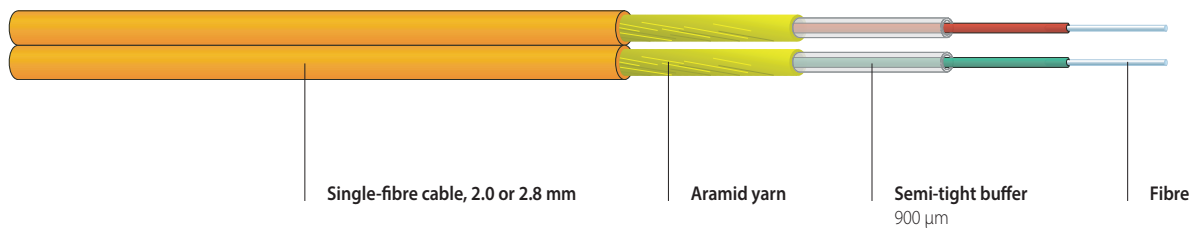

PRODUCT INFORMATION



FEATURES

Very thin and flexible Zipcord with semi-tight buffers 0.9 mm.
 The ends can easily be split into two single cables.
 Flame retardant halogen-free LS0H sheath.
 Very low fire load.

APPLICATION

Suitable for patch cables between terminal distributors and/or end devices.
 For direct termination with Simplex or Duplex connectors.

OPTICAL CHARACTERISTICS

The cables are available with different types of optical fibre (see fibre data sheets).

MECHANICAL CHARACTERISTICS

Temperature range in operation: -20 / +60°C IEC 60794-2-10
 -10 / +60°C for assembled patch cords
 Tensile performance: IEC 60794-1-2 E1 A
 Crush resistance: IEC 60794-1-2 E3
 Impact: IEC 60794-1-2 E4
 Repeated bending: IEC 60794-1-2 E6
 Torsion: IEC 60794-1-2 E7
 Bend: IEC 60794-1-2 E11 A

GENERAL CHARACTERISTICS

Sheath colour: E9/125 yellow or green
 G50/125 OM2 orange
 G50/125 OM3 turquoise
 G50/125 OM4 heather violet
 G62.5/125 OM1 grey
 Imprint: DATWYLER «cable type» «Datwyler designation» «DIN designation»
 «no. of fibres» «fibre type» «add. text» «batch no.» «meter marks»
 Zero halogen, non corrosive gases IEC 60754-1/-2, EN 50267-2-1/-2-2, VDE 0482-267-2-1/-2-2
 Flame retardant IEC 60332-1-2, EN 60332-1-2, VDE 0482-332-1-2
 Minimum smoke emission IEC 61034-1/-2, EN 61034-1/-2 (EN 50268-1/-2), VDE 0482-1034-1/-2 (VDE 0482-268-1/-2)

Description	Sheath Ø	Weight	Bending radius	Tensile load	Crush resistance	Fire load
I-V(ZN)H	mm	kg/km	mm	N	short term N	kWh/km MJ/km
Zipcord 2.0	4.1 x 2.0	8.0	50	200	1000	62 225
Zipcord 2.8	5.7 x 2.8	11.0	70	200	1000	82 295

VERSIONS

I-V(ZN)H	Fibres number	Article No.	Article No.	Article No.	Article No.	Article No.	Article No.
Description		E9/125 G.652.D	E9/125 G.652.D	G50/125 OM2	G50/125 OM3	G50/125 OM4	G62.5/125 OM1
Sheath colour		green	yellow	orange	turquoise	grey	grey
Zipcord 2.0	2	191797	191294	192147	192146	on request	191799
Zipcord 2.8	2	on request	on request	191798	on request	on request	on request

FIBRE OPTIC INDOOR CABLES

FO Indoor Duplex / I-V(ZN)HH

2.0 mm / 2.8 mm, LSOH

Semi-tight buffer

flame retardant - IEC 60332.1

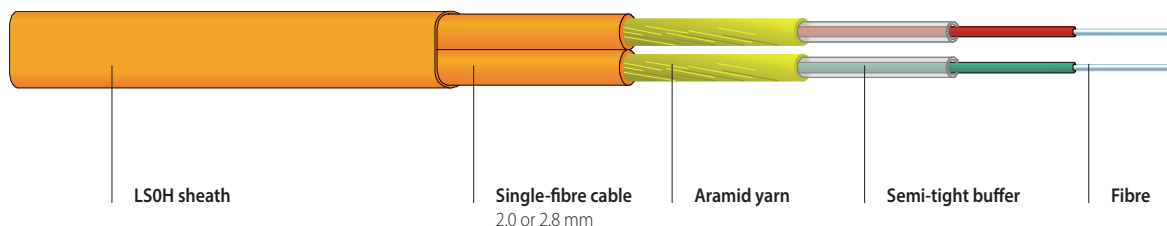

PRODUCT INFORMATION



FEATURES

Robust and flexible fibre optic Duplex cable, based on 2 single-fibre cables 2.0 or 2.8 mm with semi tight buffer 0.9 mm in a common sheath.
 Easy handling, easy to strip off.
 Flame retardant halogen-free LSOH sheath.
 Low fire load.

APPLICATION

Suitable for patch cables between terminal distributors and/or end devices.
 For direct termination with connectors.
 Can also be spliced in terminal distributors.

OPTICAL CHARACTERISTICS

The cables are available with different types of optical fibre (see fibre data sheets).

MECHANICAL CHARACTERISTICS

Temperature range in operation: -20 / +60°C IEC 60794-2-10
 -10 / +60°C for assembled patch cords
 Tensile performance: IEC 60794-1-2 E1 A
 Crush resistance: IEC 60794-1-2 E3
 Impact: IEC 60794-1-2 E4
 Repeated bending: IEC 60794-1-2 E6
 Torsion: IEC 60794-1-2 E7
 Bend: IEC 60794-1-2 E11 A

GENERAL CHARACTERISTICS

Sheath colour: E9/125 yellow or green
 G50/125 OM2 orange
 G50/125 OM3 turquoise
 G50/125 OM4 heather violet
 G62.5/125 OM1 grey
 Imprint: DATWYLER «cable type» «Datwyler designation» «DIN designation»
 «no. of fibres» «fibre type» «add. text» «batch no.» «meter marks»

- Zero halogen, non corrosive gases IEC 60754-1/-2, EN 50267-2-1/-2-2, VDE 0482-267-2-1/-2-2
- Flame retardant IEC 60332-1-2, EN 60332-1-2, VDE 0482-332-1-2
- Minimum smoke emission IEC 61034-1/-2, EN 61034-1/-2 (EN 50268-1/-2), VDE 0482-1034-1/-2 (VDE 0482-268-1/-2)

PRODUCT INFORMATION

Description	Sheath Ø	Weight	Bending radius	Tensile load	Crush resistance	Fire load
Duplex I-V(ZN)HH	mm	kg/km	mm	N	short term N	kWh/km MJ/km
Duplex	4.8 x 3.2	21	50	200	3000	100 360
Duplex	6.6 x 4.0	25	70	200	3000	120 432

VERSIONS

I-V(ZN)H	Fibres	Article No.	Article No.	Article No.	Article No.	Article No.	Article No.	Article No.	Article No.
Description	number	E9/125 G.657.A1	E9/125 G.657.A1	E9/125 G.652.D	E9/125 G.652.D	G50/125 OM2	G50/125 OM3	G50/125 OM4	G62.5/125 OM1
Sheath colour		green	yellow	green	yellow				
Duplex 2.0 mm	2	192 139	on request	192090	192091	192092	192093	192933	192094
Duplex 2.8 mm	2	on request	on request	192095	192096	192097	192098	on request	192099

FIBRE OPTIC INDOOR CABLES

FO Indoor FTTH / I-M(ZN)H

2.2 mm, LSOH

Coating buffer

flame retardant - IEC 60332.1

in accordance with IEC 60794-2-20

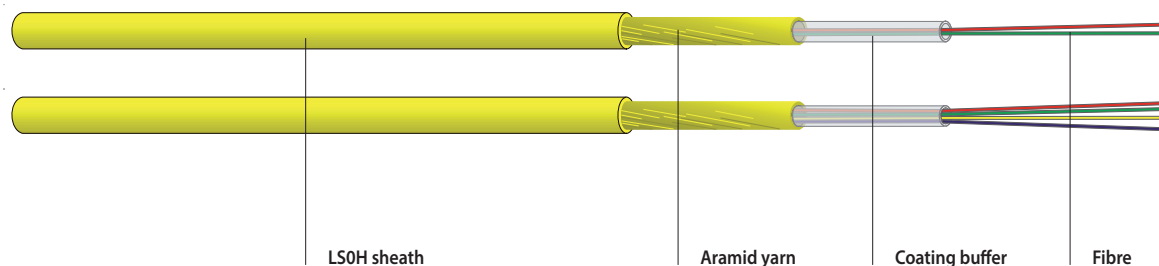

PRODUCT INFORMATION



FEATURES

Easy to handle fibre optic cable with 2 or 4 optical fibres.
 Very small outer diameter (2.2 mm) due to innovative coating buffer.
 Flame retardant halogen-free LSOH sheath. Very low fire load.
 Robust sheath for easy installation into tube systems occupied by other cables.

APPLICATION

Indoor cabling for Fibre to the Home (FTTH) applications.
 Indoor cabling for data network and building automation applications.
 Connection cable between building entry point (BEP) and FO data outlet.
 Suitable for laying in cable trays, ducts and vertical shafts.
 Can be spliced in wall mounted distribution boxes and in FO data outlets.

OPTICAL CHARACTERISTICS

The cables are available with the ITU G.657.A1 optical fibre.

MECHANICAL CHARACTERISTICS

Temperature range in operation: -20 / +60°C IEC 60794-1-2 F1
 Tensile performance: IEC 60794-1-2 E1
 Crush resistance: IEC 60794-1-2 E3
 Impact: IEC 60794-1-2 E4
 Repeated bending: IEC 60794-1-2 E6
 Torsion: IEC 60794-1-2 E7
 Bend: IEC 60794-1-2 E11

GENERAL CHARACTERISTICS

Sheath colour: yellow, similar to RAL 1021
 Imprint: DATWYLER «cable type» «Datwyler designation» «DIN designation»
 «no. of fibres» «fibre type» «add. text» «batch no.» «meter marks»

- Zero halogen, non corrosive gases IEC 60754-1/-2, EN 50267-2-1/-2-2, VDE 0482-267-2-1/-2-2
- Flame retardant IEC 60332-1-2, EN 60332-1-2, VDE 0482-332-1-2
- Minimum smoke emission IEC 61034-1/-2, EN 61034-1/-2 (EN 50268-1/-2), VDE 0482-1034-1/-2 (VDE 0482-268-1/-2)

Description	Sheath Ø	Weight	Bending radius	Tensile load	Crush resistance	Fire load
I-M(ZN)H	mm	kg/km	mm	N	short term N	kWh/km
FO Indoor FTTH 2.2, LSOH 1 x 2	2.2	4.0	25	400	500	23
FO Indoor FTTH 2.2, LSOH 1 x 4	2.2	4.0	25	400	500	23

VERSIONS

I-M(ZN)H Description	Fibres number	Article No. ITU G.657 .A1
FO Indoor FTTH 2.2, LSOH 1 x 2	2	191801
FO Indoor FTTH 2.2, LSOH 1 x 4	4	191800

Copper
Fibre Optics
Cabinets & Racks
Data Centre
Wireless
Multimedia
General Information

GF-2320 FTTH 2.2 0714/e

FIBRE OPTIC INDOOR CABLES
FO Indoor FTTH STB / I-V(ZN)H
2.8 mm, LSOH

Semi-tight buffer
 flame retardant - IEC 60332.1
 in accordance with IEC 60794-2-20

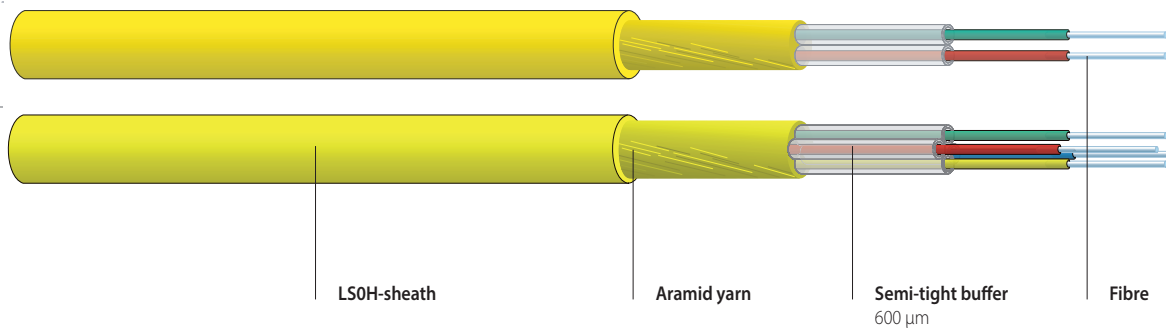

PRODUCT INFORMATION



FEATURES

Easy to handle fibre optic cable with 2 or 4 optical fibres.
 Very small outer diameter (2.8 mm) due to innovative construction with 0.6 mm semi-tight buffers.
 Flame retardant halogen-free LSOH sheath. Very low fire load.
 Robust sheath for easy installation into tube systems occupied by other cables.

APPLICATION

Indoor cabling for Fibre to the Home (FTTH) applications.
 Indoor cabling for data network and building automation applications.
 Connection cable between building entry point (BEP) and FO data outlet.
 Suitable for laying in cable trays, ducts and vertical shafts.
 For direct termination with FO connectors. Suitable for splicing.

OPTICAL CHARACTERISTICS

The cables are available with the ITU G.657.A1 optical fibre.

MECHANICAL CHARACTERISTICS

Temperature range in operation: -20 / +60°C IEC 60794-1-2 F1
 Tensile performance: IEC 60794-1-2 E1
 Crush resistance: IEC 60794-1-2 E3
 Impact: IEC 60794-1-2 E4
 Repeated bending: IEC 60794-1-2 E6
 Torsion: IEC 60794-1-2 E7
 Bend: IEC 60794-1-2 E11

GENERAL CHARACTERISTICS

Sheath colour: yellow, similar to RAL 1021
 Imprint: DATWYLER «cable type» «Datwyler designation» «DIN designation»
 «no. of fibres» «fibre type» «add. text» «batch no.» «meter marks»

- Zero halogen, non corrosive gases IEC 60754-1/-2, EN 50267-2-1/-2-2, VDE 0482-267-2-1/-2-2
- Flame retardant IEC 60332-1-2, EN 60332-1-2, VDE 0482-332-1-2
- Minimum smoke emission IEC 61034-1/-2, EN 61034-1/-2 (EN 50268-1/-2), VDE 0482-1034-1/-2 (VDE 0482-268-1/-2)

Description	Sheath Ø	Weight	Bending radius	Tensile load	Crush resistance	Fire load
I-V(ZN)H	mm	kg/km	mm	N	short term N	kWh/km
FO Indoor FTTH 2.8, LSOH 2 x 1	2.8	7.5	25	400	500	41
FO Indoor FTTH 2.8, LSOH 4 x 1	2.8	8.0	25	400	500	43

VERSIONS

I-V(ZN)H	Fibres	Article No.
Description	number	ITU G.657 .A1
FO Indoor FTTH 2.8, LSOH 2 x 1	2	193409
FO Indoor FTTH 2.8, LSOH 4 x 1	4	193410

FIBRE OPTIC INDOOR CABLES

FO Indoor BO / I-V(ZN)HH

Breakout, 2.0 mm, FR/LSOH

Semi-tight buffer, flame retardant
in accordance with IEC 60332.1 and IEC 60332.3 C

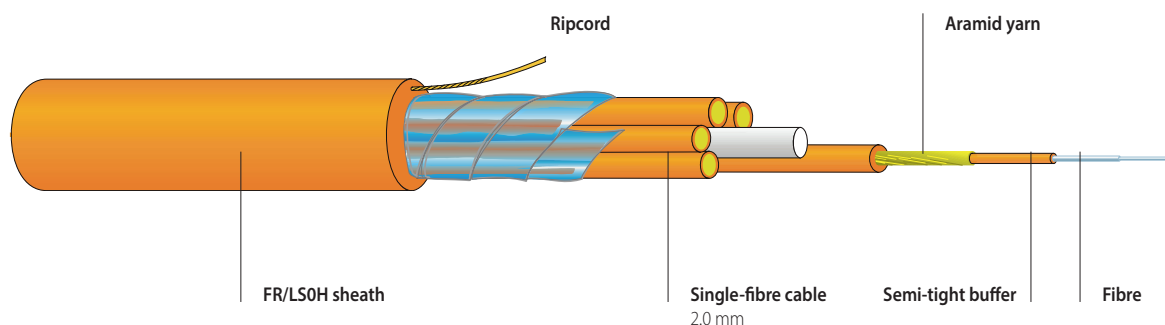

PRODUCT INFORMATION



FEATURES

Robust and flexible fibre optic breakout cable, based on 2 up to 12 single-fibre cables 2.0 mm with semi-tight buffer 0.9 mm in a common sheath.
Easy handling, easy to strip off.
Flame retardant halogen-free FR/LSOH sheath.
Very low fire load.

APPLICATION

LAN backbone.
Connection cable between the building distributors and/or floor distributors.
Suitable for laying in cable trays, ducts and vertical shafts.
For direct termination with FO connectors.
Can also be spliced in FO distributors.

OPTICAL CHARACTERISTICS

The cables are available with different types of optical fibre (see fibre data sheets).

MECHANICAL CHARACTERISTICS

Temperature range in operation: -20 / +60°C IEC 60794-2-20
Tensile performance: IEC 60794-1-2 E1 A
Crush resistance: IEC 60794-1-2 E3
Impact: IEC 60794-1-2 E4
Repeated bending: IEC 60794-1-2 E6
Torsion: IEC 60794-1-2 E7
Bend: IEC 60794-1-2 E11 A

GENERAL CHARACTERISTICS

Sheath colour: E9/125 OS2 yellow or green
G50/125 OM2 orange
G50/125 OM3 turquoise
G50/125 OM4 heather violet
G62.5/125 OM1 grey

Imprint: DATWYLER «cable type» «Datwyler designation» «DIN designation»
«number of fibres» «fibre type» «additional text» «batch number»
~ ~ «meter marks» ~ ~

- Zero halogen, non corrosive gases IEC 60754-1/-2, EN 50267-2-1/-2-2, VDE 0482-267-2-1/-2-2
- Flame retardant IEC 60332-1-2, EN 60332-1-2, VDE 0482-332-1-2
- Fire resistant (no flame propagation) IEC 60332.3 C, EN 50266-2-4, VDE 0482-266-2-4
- Minimum smoke emission IEC 61034-1/-2, EN 61034-1/-2 (EN 50268-1/-2), VDE 0482-1034-1/-2 (VDE 0482-268-1/-2)

FIBRE OPTIC INDOOR CABLES
FO Indoor BO / I-V(ZN)HH

Breakout, 2.0 mm, L50H

Semi-tight buffer, flame retardant
in accordance with IEC 60332.1 and IEC 60332.3 C

PRODUCT INFORMATION

Description	I-V(ZN)HH	Sheath Ø	Weight	Bending radius	Tensile load	Crush resistance		Fire load	
						mm	kg/km	mm	N
Breakout	2 x 1	7.0	48	105	1000	1000	3000	110	396
Breakout	4 x 1	7.0	48	105	1000	1000	3000	120	432
Breakout	6 x 1	9.0	83	135	1000	1000	3000	165	594
Breakout	8 x 1	9.0	83	135	1000	1000	3000	181	652
Breakout	12 x 1	12.0	138	180	1000	1000	3000	323	1160

VERSIONS

I-V(ZN)HH	Fibres	Article No.	Article No.	Article No.	Article No.	Article No.
description	number	E9/125 OS2/G.652.D	G50/125 OM4	G50/125 OM3	G50/125 OM2	G62,5/125 OM1
Sheath colour		green (or yellow)	heather violet	turquoise	orange	grey
Breakout 2 x 1	2	309262	on request	309294	309265	309268
Breakout 4 x 1	4	309263	309470	309295	309266	309293
Breakout 6 x 1	6	309290	on request	309428	309292	on request
Breakout 8 x 1	8	309291	on request	on request	on request	on request
Breakout 12 x 1	12	309264	on request	on request	309267	on request

FIBRE OPTIC UNIVERSAL CABLES

FO Universal ZGGFR / U-DQ(ZN)BH

for indoor and outdoor use, up to 24 fibres

metal-free, dry interstices,
rodent protection, flame retardant,
in accordance with IEC 60332.1 and IEC 60332.3 C

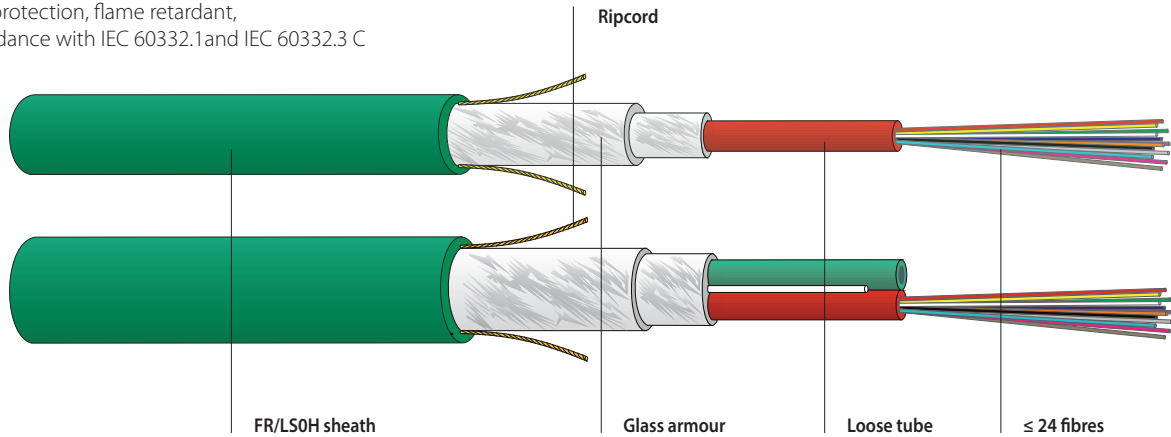

PRODUCT INFORMATION



FEATURES

Robust, non-metallic fibre optic outdoor and indoor cable with one or two central loose-tubes. High crush resistance for high transmission reliability. Easy handling due to cable construction with dry interstices. Non-metallic rodent protection. The two coloured ripcords are easy to identify and enable the safe opening of the cable sheath. Flame retardant halogen-free FR/LSOH sheath.

APPLICATION

LAN backbone, access and riser zone. Connection cable between the building distributors and/or floor distributors. Suitable for laying in cable trays, ducts and vertical shafts. Can also be spliced in all FO distributors and joints.

OPTICAL CHARACTERISTICS

The cables are available with different types of optical fibre (see fibre data sheets).

MECHANICAL CHARACTERISTICS

Temperature range	storage:	-25 / +70°C	EN 60794-1-2 F1
	during installation:	-10 / +50°C	
	in operation:	-25 / +60°C	
Tensile performance:	IEC 60794-1-2 E1/test criterion 0.33% reversible optical fibre elongation		
Crush resistance:	IEC 60794-1-2 E3		
Impact:	IEC 60794-1-2 E4		
Repeated bending:	IEC 60794-1-2 E6		
Torsion:	IEC 60794-1-2 E7		
Bend:	IEC 60794-1-2 E11		
Water penetration:	IEC 60794-1-2 F5		

GENERAL CHARACTERISTICS

Sheath colour: green, similar to RAL 6016
 Imprint: DATWYLER «cable type» «Datwyler designation» «DIN designation» «number of fibres» «fibre type» «additional text» «batch number»
 ~ ~ «meter marks» ~ ~

- Zero halogen, non corrosive gases IEC 60754-1/-2, EN 50267-2-1/-2-2, VDE 0482-267-2-1/-2-2
- Flame retardant IEC 60332-1-2, EN 60332-1-2, VDE 0482-332-1-2
- Fire resistant (no flame propagation) IEC 60332.3 C, EN 50266-2-4, VDE 0482-266-2-4
- Minimum smoke emission IEC 61034-1/-2, EN 61034-1/-2 (EN 50268-1/-2), VDE 0482-1034-1/-2 (VDE 0482-268-1/-2)

FO Universal ZGGFR / U-DQ(ZN)BH

for indoor and outdoor use, up to 24 fibres

metal-free, dry interstices,

rodent protection, flame retardant,

in accordance with IEC 60332.1 and IEC 60332.3 C

PRODUCT INFORMATION

Description	No. of fibres	Loose tubes	Sheath Ø	Weight	Bending radius	Tensile load*	Crush resistance		Fire load	
U-DQ(ZN)BH n x m	max.	max.	mm	kg/km	mm	N	continuous N	short term N	kWh/km	MJ/km
FO Universal 1 x n	12	1	7.6	68	115	1500	3000	5000	275	990
FO Universal 1 x n	12	1	8.2	73	125	3000	3000	5000	336	1210
FO Universal 2 x 12	24	2	9.5	96	140	2800	3000	5000	430	1548
FO Universal 1 x 24	24	1	8.2	73	125	3000	3000	5000	336	1210

* Test criterion 0.33% reversible optical fibre elongation

VERSIONS

U-DQ(ZN)BH n x m	Fibres	Article No.	Article No.	Article No.	Article No.	Article No.	Article No.	
Description	number	E9/125 G.657.A1	E9/125 G.652.D	G50/125 OM2	G50/125 OM3	G50/125 OM4	G62.5/125 OM1	
FO Universal (1500 N)	1 x 4	4	-	190203	185938	185989	192712	185990
FO Universal (1500 N)	1 x 6	6	-	190204	186459	190112	193360	186355
FO Universal (1500 N)	1 x 8	8	-	190205	186300	185959	187363	185934
FO Universal (1500 N)	1 x 12	12	193314	190077	185935	186350	191251	186005
FO Universal (2800 N)	2 x 12	24	-	190071	186356	186432	191252	186487
FO-Universal (3000 N)	1 x 12	12	-	192970	192967	192968	192969	-
FO Universal (3000 N)	1 x 24	24	193337	187354	186595	191755	192713	191753
FO Universal-Hybrid (2800 N)	1x 12 E9 + 1x 12 G50*	24	-	-	190378	190137	190124	-

* 12 fibres E9 in the red loose tube, 12 fibres G50 in the green loose tube

FIBRE OPTIC UNIVERSAL CABLES

FO Universal wbGGFR / U-DQ(ZN)BH

for indoor and outdoor use, up to 144 fibres

metal-free, dry interstices,

rodent protection, flame retardant,

in accordance with IEC 60332.1 and IEC 60332.3 C

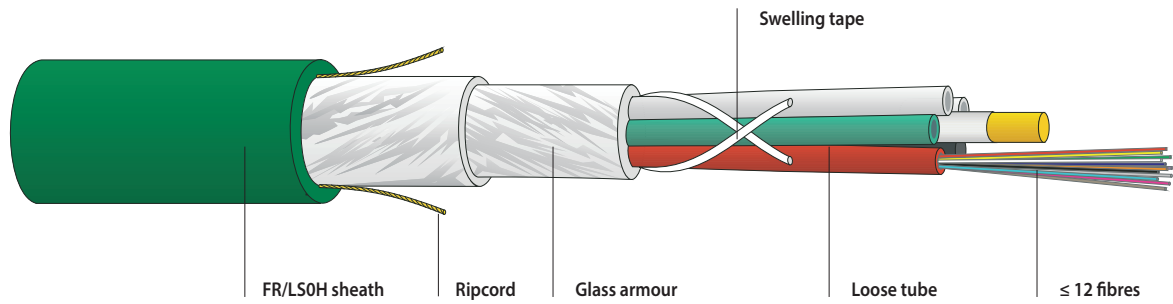

PRODUCT INFORMATION



FEATURES

Robust, metal-free fibre optic outdoor and indoor cable with stranded loose tubes.
High crush resistance for high transmission reliability.
Easy to handle due to cable construction with dry interstices.
Non-metallic rodent protection.
The two coloured ripcords are easy to identify and enable the safe opening of the cable sheath.
Flame retardant halogen-free FR/LSOH sheath.

APPLICATION

LAN backbone, access and riser zone.
Connection cable between the building distributors and/or floor distributors.
Suitable for laying in cable trays, ducts and vertical shafts.
Can also be spliced in all FO distributors and joints.

OPTICAL CHARACTERISTICS

The cables are available with different types of optical fibre (see fibre data sheets).

MECHANICAL CHARACTERISTICS

Temperature range	storage:	-25 / +70°C	IEC 60794-1-2 F1
	during installation:	-10 / +50°C	
	in operation:	-25 / +60°C	
Tensile performance:	IEC 60794-1-2 E1N		
Crush resistance:	IEC 60794-1-2 E3		
Impact:	IEC 60794-1-2 E4		
Repeated bending:	IEC 60794-1-2 E6		
Torsion:	IEC 60794-1-2 E7		
Bend:	IEC 60794-1-2 E11		
Water penetration:	IEC 60794-1-2 F5		

GENERAL CHARACTERISTICS

Sheath colour: green, similar to RAL 6016
Imprint: DATWYLER «cable type» «Datwyler designation» «DIN designation»
«number of fibres» «fibre type» «additional text» «batch number»
~ ~ «meter marks» ~ ~

Zero halogen, non corrosive gases	IEC 60754-1/-2, EN 50267-2-1/-2-2, VDE 0482-267-2-1/-2-2
Flame retardant	IEC 60332-1-2, EN 60332-1-2, VDE 0482-332-1-2
Fire resistant (no flame propagation)	IEC 60332.3 C, EN 50266-2-4, VDE 0482-266-2-4
Minimum smoke emission	IEC 61034-1/-2, EN 61034-1/-2 (EN 50268-1/-2), VDE 0482-1034-1/-2 (VDE 0482-268-1/-2)

FO Universal wbGGFR / U-DQ(ZN)BH

for indoor and outdoor use, up to 144 fibres

metal-free, dry interstices,
rodent protection, flame retardant,
in accordance with IEC 60332.1 and IEC 60332.3 C

PRODUCT INFORMATION

Description	No. of fibres	Loose tube	Sheath Ø	Weight	Bending radius	Tensile load	Crush resistance		Fire load	
U-DQ(ZN)BH n x m	max.	max.	mm	kg/km	mm	N	continuous N	short term N	kWh/km	MJ/km
FO Universal 5 x 12 *	60	5	11.4*	148*	175*	6000*	3000*	5000*	616*	2218*
FO Universal 6 x 12	72	6	12.2	164	185	6000	3000	5000	681	2452
FO Universal 8 x 12	96	8	13.5	198	205	6000	3000	5000	808	3200
FO Universal 10 x 12	120	10	14.8	230	225	6000	3000	5000	936	3369
FO Universal 12 x 12	144	12	16.3	272	245	6000	3000	5000	1075	3870

* Technical parameters apply to all cable constructions with ≤ 60 fibres.

VERSIONS

U-DQ(ZN)BH n x m	Fibres	Article No.	Article No.	Article No.	Article No.	Article No.
Description	number	E9/125 G.652.D	G50/125 OM2	G50/125 OM3	G50/125 OM4	G62.5/125 OM1
FO Universal 3 x 12	36	190207	186434	auf Anfrage	192678	186488
FO Universal 4 x 12	48	190208	187291	186486	191278	187292
FO Universal 5 x 12	60	190209	190618	186642	on request	192170
FO Universal 6 x 12	72	190210	187344	186539	on request	on request
FO Universal 8 x 12	96	186747	on request	186540	192714	on request
FO Universal 10 x 12	120	190211	on request	186536	on request	on request
FO Universal 12 x 12	144	190212	186616	191710	192715	on request

FIBRE OPTIC UNIVERSAL CABLES

FO Universal ZGGFR Safety / U-DQ(ZN)BH

Safety cable E30

metal-free, water resistant, rodent protection,
in accordance with IEC 60332.1 and IEC 60332.3 C

30 minutes System Circuit Integrity according to DIN 4102-12

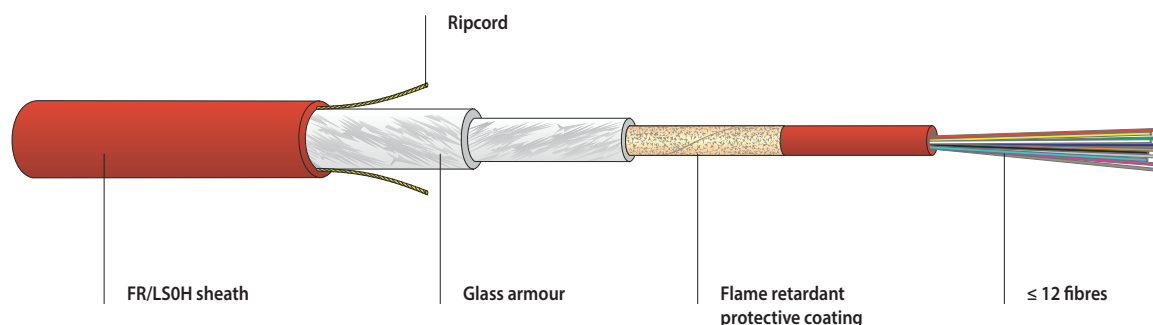

PRODUCT INFORMATION



FEATURES

Metal-free fibre optic safety cable with one central loose tube, up to 12 fibres. The optimal combination of flame retardant fibre coating and flame-inhibiting stabilizing elements ensures enhanced functional integrity (System Circuit Integrity) in case of fire for 30 minutes (transmission of audio, video and 1Gbit/s signals approved by a certified test report).

APPLICATION

Safety applications in tunnels, underground railways, banks, insurance companies, large-scale industry. LAN backbone. Indoor and outdoor cabling. Can be installed in cable platforms, trays, ducts and vertical shafts. Can be spliced in FO distributors.

OPTICAL CHARACTERISTICS

The cables are available with different types of optical fibre (see fibre data sheets).

MECHANICAL CHARACTERISTICS

Temperature range	storage:	-25 / +70°C	IEC 60794-1-2 F1
	during installation:	-10 / +50°C	
	in operation:	-25 / +60°C	
Tensile performance:	IEC 60794-1-2 E1		
Crush resistance:	IEC 60794-1-2 E3		
Impact:	IEC 60794-1-2 E4		
Repeated bending:	IEC 60794-1-2 E6		
Torsion:	IEC 60794-1-2 E7		
Bend:	IEC 60794-1-2 E11		
Water penetration:	IEC 60794-1-2 F5		

GENERAL CHARACTERISTICS

Imprint: DATWYLER «cable type» «Datwyler designation» «DIN designation» «number of fibres» «fibre type» «additional text» «batch number» ~ ~ «meter marks» ~ ~

- Zero halogen, non corrosive gases IEC 60754-1/-2, EN 50267-2-1/-2-2, VDE 0482-267-2-1/-2-2
- Flame retardant IEC 60332-1-2, EN 60332-1-2, VDE 0482-332-1-2
- Fire resistant (no flame propagation) IEC 60332.3 C, EN 50266-2-4, VDE 0482-266-2-4
- Minimum smoke emission IEC 61034-1/-2, EN 61034-1/-2 (EN 50268-1/-2), VDE 0482-1034-1/-2 (VDE 0482-268-1/-2)
- Circuit Integrity (FE180) FE180 IEC 60331-11, -25, VDE 0472 part 814, EN 50200 PH 90, EN 50362, VDE 0482-200, VDE 0482-362
- System Circuit Integrity E30* according to DIN 4102 part 12
*System Circuit Integrity E30 is dependent on installation method

ACCESSORIES

You can find the necessary, E30-tested and certified fire safety system components in our catalogue "System Circuit Integrity" and on our homepage.

FO Universal ZGGFR Safety / U-DQ(ZN)BH

Safety cable E30

metal-free, water resistant, rodent protection,
in accordance with IEC 60332.1 and IEC 60332.3 C
30 minutes System Circuit Integrity according to DIN 4102-12

PRODUCT INFORMATION

Description	No. of fibres	Loose tube	Sheath Ø	Weight	Bending radius	Tensile load	Crush resistance			Fire load	
U-DQ(ZN)BH 1 x m	max.		mm	kg/km	mm	N	continuous N	short term N	kWh/km	MJ/km	
ZGGFR Safety 1 x n	12	1	7.8	72	120	1000	2000	5000	301	1084	

VERSIONS

U-DQ(ZN)BH 1 x m		Fibres	Article No.	Article No.	Article No.	Article No.	Article No.
Description		number	E9/125 G.652.D	G50/125 OM2	G50/125 OM3	G50/125 OM4	G62.5/125 OM1
ZGGFR Safety	1 x 4	4	187288	186363	190604	193447	186638
ZGGFR Safety	1 x 6	6	191867	186639	191851	193448	190792
ZGGFR Safety	1 x 8	8	on request	190621	on request	193449	on request
ZGGFR Safety	1 x 12	12	190719	187293	191796	193450	187305

FIBRE OPTIC UNIVERSAL CABLES

FO Universal wbGGFR Safety / U-DQ(ZN)BH

Safety cable E30

metal-free, water resistant, rodent protection,
in accordance with IEC 60332.1 and IEC 60332.3 C

30 minutes System Circuit Integrity according to DIN 4102-12

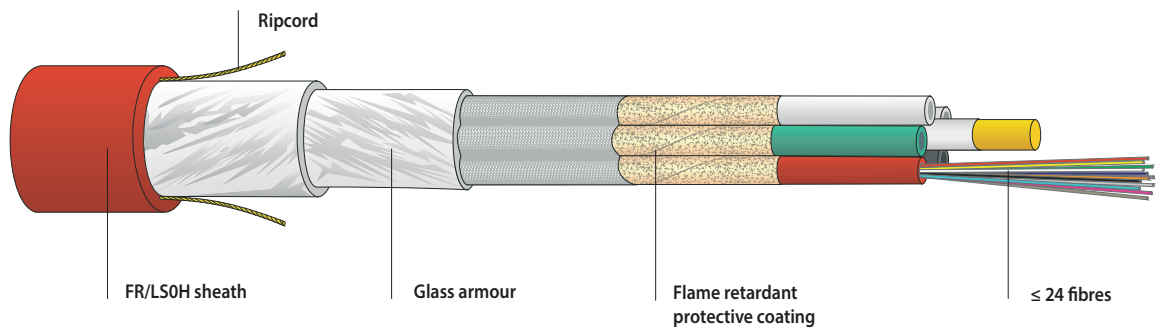

PRODUCT INFORMATION



FEATURES

Metal-free fibre optic safety cable with multiple loose tubes, up to 60 fibres.
The optimal combination of flame retardant fibre coating and flame-inhibiting stabilizing elements ensures enhanced functional integrity (System Circuit Integrity) in case of fire for 30 minutes (transmission of audio, video and 1Gbit/s signals approved by a certified test report).

APPLICATION

Safety applications in tunnels, underground railways, banks, insurance companies, large-scale industry.
LAN backbone.

Indoor and outdoor cabling.

Can be installed in cable platforms, trays, ducts and vertical shafts.

Can be spliced in FO distributors.

The cables are available with different types of optical fibre (see fibre data sheets).

OPTICAL CHARACTERISTICS

Temperature range	storage:	-25 / +70°C	IEC 60794-1-2 F1
	during installation:	-10 / +50°C	
	in operation:	-25 / +60°C	

MECHANICAL CHARACTERISTICS

Tensile performance:	IEC 60794-1-2 E1
Crush resistance:	IEC 60794-1-2 E3
Repeated bending:	IEC 60794-1-2 E6
Torsion:	IEC 60794-1-2 E7
Bend:	IEC 60794-1-2 E11
Water penetration:	IEC 60794-1-2 F5

GENERAL CHARACTERISTICS

Imprint: DATWYLER «cable type» «Datwyler designation» «DIN designation»
«number of fibres» «fibre type» «additional text» «batch number»
~ ~ «meter marks» ~ ~

Zero halogen, non corrosive gases	IEC 60754-1/-2, EN 50267-2-1/-2-2, VDE 0482-267-2-1/-2-2
Flame retardant	IEC 60332-1-2, EN 60332-1-2, VDE 0482-332-1-2
Fire resistant (no flame propagation)	IEC 60332.3 C, EN 50266-2-4, VDE 0482-266-2-4
Minimum smoke emission	IEC 61034-1/-2, EN 61034-1/-2 (EN 50268-1/-2), VDE 0482-1034-1/-2 (VDE 0482-268-1/-2)
Circuit Integrity (FE180)	FE180 IEC 60331-11, -25, VDE 0472 part 814, EN 50200 PH 90, EN 50362, VDE 0482-200, VDE 0482-362
System Circuit Integrity E30*	according to DIN 4102 part 12

*System Circuit Integrity is dependent on installation method

ACCESSORIES

You can find the necessary, E30-tested and certified fire safety system components in our catalogue "System Circuit Integrity" and on our homepage.

FO Universal wbGGFR Safety / U-DQ(ZN)BH

Safety cable E30

metal-free, water resistant, rodent protection,
in accordance with IEC 60332.1 and IEC 60332.3 C
30 minutes System Circuit Integrity according to DIN 4102-12

PRODUCT INFORMATION

Description	No. of fibres	Loose tubes	Sheath Ø	Weight	Bending radius	Tensile load	Crush resistance		Fire load	
U-DQ(ZN)BH n x m	max.	max.	mm	kg/km	mm	N	continuous N	short term N	kWh/km	MJ/km
wbGGFR Safety 2 x 12	24	2	12.5	166	190	6000	3000	5000	733	2639
wbGGFR Safety 3 x 12	36	3	12.5	168	190	6000	3000	5000	733	2639
wbGGFR Safety 4 x 12	48	4	12.5	170	190	6000	3000	5000	733	2639
wbGGFR Safety 5 x 12	60	5	12.5	166	190	6000	3000	5000	733	2639

VERSIONS

U-DQ(ZN)BH n x m	Fibres	Article No.	Article No.	Article No.	Article No.	Article No.
Bezeichnung	Anzahl	E9/125 G.652.D	G50/125 OM2	G50/125 OM3	G50/125 OM4	G62.5/125 OM1
wbGGFR Safety 2 x 12	24	190223	187294	187360	193454	on request
wbGGFR Safety 3 x 12	36	190224	on request	on request	193455	on request
wbGGFR Safety 4 x 12	48	190225	192119	191191	193456	on request
wbGGFR Safety 5 x 12	60	190226	on request	190605	193457	on request

FIBRE OPTIC UNIVERSAL CABLES

FO Universal ZGGFR Easy Blow / U-DQ(ZN)BH

Fire resistant, optimized for blowing through thermoplastic ducts

metal-free, rodent protection,

in accordance with IEC 60332.1 and IEC 60332.3 C

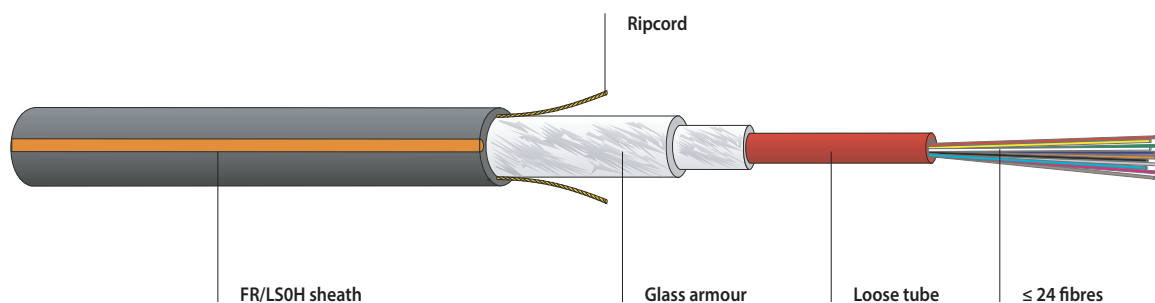

PRODUCT INFORMATION



FEATURES

Robust, metal-free fibre optic outdoor and indoor cable with one central loose tube. Optimized for blowing through thermoplastic ducts: Its good greasing characteristics, smooth and strong sheath surface and good internal strength provide for an axial linear motion and reduced friction (in comparison with standard indoor/outdoor cables). Therefore a blowing length of up to 2000 m is possible. Non-metallic rodent protection. Flame retardant and fire resistant sheath with very low fire load. The coloured ripcords are easy to identify and enable the safe opening of the cable sheath.

APPLICATION

For blowing through thermoplastic ducts with blowing lengths of up to 2000 m. In Premises cabling for LAN backbones (Campus and Vertical/Riser cabling) as well as for tunnels.

OPTICAL CHARACTERISTICS

The cables are available with different types of optical fibre (see fibre data sheets).

MECHANICAL CHARACTERISTICS

Temperature range	storage:	-25 / +70°C	IEC 60794-1-2 F1
	during installation:	-10 / +50°C	
	in operation:	-25 / +60°C	
Tensile performance:	IEC 60794-1-2 E1		
Crush resistance:	IEC 60794-1-2 E3		
Impact:	IEC 60794-1-2 E4		
Repeated bending:	IEC 60794-1-2 E6		
Torsion:	IEC 60794-1-2 E7		
Bend:	IEC 60794-1-2 E11		
Water penetration:	IEC 60794-1-2 F5		

GENERAL CHARACTERISTICS

Imprint: DATWYLER «cable type» «Datwyler designation» «DIN designation» «number of fibres» «fibre type» «additional text» «batch number» ~ ~ «meter marks» ~ ~

Zero halogen, non corrosive gases	IEC 60754-1/-2, EN 50267-2-1/-2-2, VDE 0482-267-2-1/-2-2
Flame retardant	IEC 60332-1-2, EN 60332-1-2, VDE 0482-332-1-2
Fire resistant (no flame propagation)	IEC 60332.3 C, EN 50266-2-4, VDE 0482-266-2-4
Minimum smoke emission	IEC 61034-1/-2, EN 61034-1/-2 (EN 50268-1/-2), VDE 0482-1034-1/-2 (VDE 0482-268-1/-2)

FO Universal ZGGFR Easy Blow / U-DQ(ZN)BH

Fire resistant, optimized for blowing through thermoplastic ducts

metal-free, rodent protection,
in accordance with IEC 60332.1 and IEC 60332.3 C

PRODUCT INFORMATION

Description	No. of fibres	Loose tube	Sheath Ø	Weight	Bending radius	Tensile load	Crush resistance		Fire load	
U-DQ(ZN)BH n x m			mm	kg/km	mm	N	continuous N	short term N	kWh/km	MJ/km
ZGGFR Easy Blow 1 x 12	12	1	8.5	84	140	2500	2000	3000	356	1280
ZGGFR Easy Blow 1 x 24	24	1	9.0	95	145	2500	2000	3000	400	1435

VERSIONS

U-DQ(ZN)BH n x m	Fibres	Article No.	Article No.	Article No.	Article No.	Article No.
Description	number	E9/125 G.652.D	G50/125 OM2	G50/125 OM3	G50/125 OM4	G62.5/125 OM1
ZGGFR Easy Blow 1 x 4	4	190617	191277	191825	on request	190754
ZGGFR Easy Blow 1 x 6	6	190363	on request	on request	on request	on request
ZGGFR Easy Blow 1 x 8	8	191700	on request	on request	on request	on request
ZGGFR Easy Blow 1 x 12	12	190213	on request	on request	on request	192148
ZGGFR Easy Blow 1 x 24	24	190214	on request	on request	on request	on request

FIBRE OPTIC UNIVERSAL CABLES

FO Universal wbGGFR Easy Blow / U-DQ(ZN)BH

Fire resistant, optimized for blowing through thermoplastic ducts

metal-free, dry interstices, rodent protection,
in accordance with IEC 60332.1 and IEC 60332.3 C

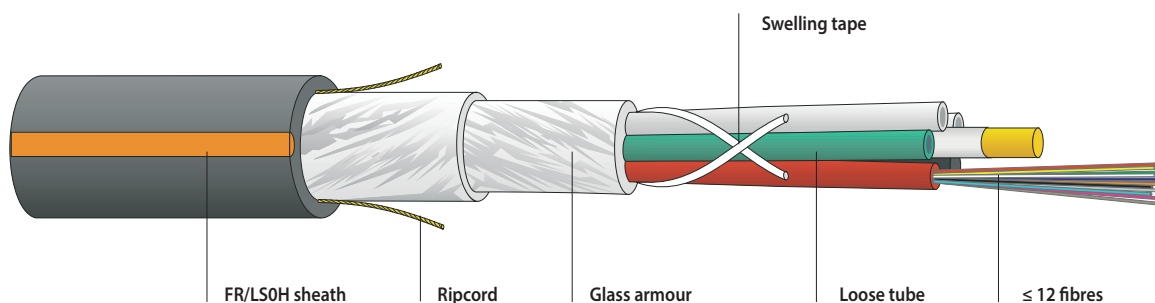

PRODUCT INFORMATION



FEATURES

Robust, metal-free fibre optic outdoor and indoor cable with stranded loose tubes.
Optimized for blowing through thermoplastic ducts:
Its good greasing characteristics, smooth and strong sheath surface and good internal strength provide for an axial linear motion and reduced friction (in comparison with standard indoor/outdoor cables). Therefore a blowing length of up to 2000 m is possible.
Non-metallic rodent protection.
Flame retardant and fire resistant sheath with very low fire load.
The coloured ripcords are easy to identify and enable the safe opening of the cable sheath.

APPLICATION

For blowing through thermoplastic ducts with blowing lengths of up to 2000 m.
In Premises cabling for LAN backbones (Campus and Vertical/Riser cabling) as well as for tunnels.

OPTICAL CHARACTERISTICS

The cables are available with different types of optical fibre (see fibre data sheets).

MECHANICAL CHARACTERISTICS

Temperature range	storage:	-25 / +70°C	IEC 60794-1-2 F1
	during installation:	-10 / +50°C	
	in operation:	-25 / +60°C	
Tensile performance:	IEC 60794-1-2 E1		
Crush resistance:	IEC 60794-1-2 E3		
Impact:	IEC 60794-1-2 E4		
Repeated bending:	IEC 60794-1-2 E6		
Torsion:	IEC 60794-1-2 E7		
Bend:	IEC 60794-1-2 E11		
Water penetration:	IEC 60794-1-2 F5		

GENERAL CHARACTERISTICS

Imprint: DATWYLER «cable type» «Datwyler designation» «DIN designation»
«number of fibres» «fibre type» «additional text» «batch number»
~ ~ «meter marks» ~ ~

Zero halogen,	IEC 60754-1/-2, EN 50267-2-1/-2-2, VDE 0482-267-2-1/-2-2
non corrosive gases	
Flame retardant	IEC 60332-1-2, EN 60332-1-2, VDE 0482-332-1-2
Fire resistant	IEC 60332.3 C, EN 50266-2-4,
(no flame propagation)	VDE 0482-266-2-4
Minimum smoke emission	IEC 61034-1/-2, EN 61034-1/-2 (EN 50268-1/-2), VDE 0482-1034-1/-2 (VDE 0482-268-1/-2)

FO Universal wbGGFR Easy Blow / U-DQ(ZN)BH

Fire resistant, optimized for blowing through thermoplastic ducts

metal-free, dry interstices, rodent protection,
in accordance with IEC 60332.1 and IEC 60332.3 C

PRODUCT INFORMATION

Description	No. of fibres	Loose tubes	Sheath Ø	Weight	Bending radius	Tensile load	Crush resistance			Fire load	
U-DQ(ZN)BH n x m			mm	kg/km	mm	N	continuous N	short term N	kWh/km	MJ/km	
wbGGFR5 Easy Blow 5 x 12	60	5	12.0*	154*	180*	9000*	3000*	5000*	627*	2257*	
wbGGFR6 Easy Blow 6 x 12	72	6	12.8	175	195	9000	3000	5000	698	2513	
wbGGFR8 Easy Blow 8 x 12	96	8	14.0	208	210	9000	3000	5000	925	3330	
wbGGFR10 Easy Blow 10 x 12	120	10	15.4	243	230	9000	3000	5000	1151	4144	
wbGGFR12 Easy Blow 12 x 12	144	12	16.9	286	255	9000	3000	5000	1367	4921	
wbGGFR12 Easy Blow 12 x 24	288	12	18.8	356	285	9000	3000	5000	1435	5165	

* Technical parameters apply to all cable constructions with ≤ 60 fibres.

VERSIONS

U-DQ(ZN)BH n x m	Fibres number	Article No. E9/125 G.652.D	Article No. G50/125 OM2	Article No. G50/125 OM3	Article No. G62.5/125 OM1
wbGGFR5 Easy Blow 1 x 12	12	190602	on request	–	186756
wbGGFR5 Easy Blow 2 x 12	24	190215	186645	192156	186561
wbGGFR5 Easy Blow 3 x 12	36	190692	187319	–	on request
wbGGFR5 Easy Blow 4 x 12	48	190216	on request	–	186757
wbGGFR5 Easy Blow 5 x 12	60	190217	on request	–	on request
wbGGFR6 Easy Blow 6 x 12	72	190218	on request	–	190753
wbGGFR8 Easy Blow 8 x 12	96	190219	on request	–	186758
wbGGFR10 Easy Blow 10 x 12	120	190220	on request	–	on request
wbGGFR12 Easy Blow 12 x 12	144	190221	on request	–	on request
wbGGFR12 Easy Blow 12 x 24	288	191701	on request	–	on request

FIBRE OPTIC UNIVERSAL CABLES

FO Universal wbGGFR Combi / U-DQS(ZN)BH

Combination cable with 3 stranded copper wires, indoor and outdoor use

dry interstices, rodent protection,
in accordance with IEC 60332.1 and IEC 60332.3 .C

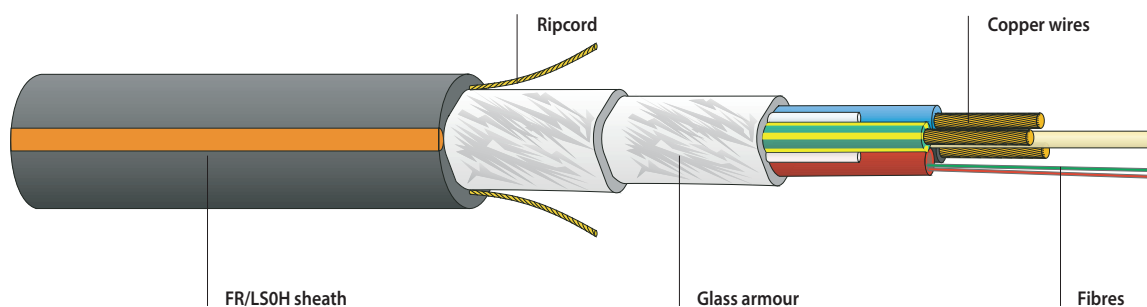

PRODUCT INFORMATION



FEATURES

The glass armour provides for a combined non-metallic rodent protection and strain relief.
Two ripcords enable the safe opening of the cable sheath.
Dry stranding interstices - easy handling.
Longitudinal water resistance.
Flame retardant, flame resistant cable sheath.

APPLICATION

Camera combi cable in tunnels, underground railroads, large-scale industry.
Pulling in or blowing through thermoplastic ducts.
Laying on cable platforms and cable trays.
Direct burial.

OPTICAL CHARACTERISTICS

The cables are available with different types of optical fibre (see fibre data sheets).

MECHANICAL CHARACTERISTICS

Temperature range	storage:	-25 / +70°C	IEC 60794-1-2 F1
	during installation:	-10 / +50°C	
	in operation:	-25/ +60°C	
Tensile performance:		IEC 60794-1-2 E1	
Crush resistance:		IEC 60794-1-2 E3	
Impact:		IEC 60794-1-2 E4	
Repeated bending:		IEC 60794-1-2 E6	
Torsion:		IEC 60794-1-2 E7	
Bend:		IEC 60794-1-2 E11	
Water penetration:		IEC 60794-1-2 F5	

GENERAL CHARACTERISTICS

Imprint:	DATWYLER «cable type» «Datwyler designation» «DIN designation» «number of fibres» «fibre type» «additional text» «batch number» ~ ~ «meter marks» ~ ~
Zero halogen, non corrosive gases	IEC 60754-1/-2, EN 50267-2-1/-2-2, VDE 0482-267-2-1/-2-2
Flame retardant	IEC 60332-1-2, EN 60332-1-2, VDE 0482-332-1-2
Fire resistant (no flame propagation)	IEC 60332.3 C, EN 50266-2-4, VDE 0482-266-2-4
Minimum smoke emission	IEC 61034-1/-2, EN 61034-1/-2 (EN 50268-1/-2), VDE 0482-1034-1/-2 (VDE 0482-268-1/-2)

Description	No. of fibres	Sheath Ø mm	Weight kg/km	Bending radius mm	Tensile load N	Crush resistance short term N
wbGGFR Combi 1 x 2 + 3 x 2.5 mm ²	2	13.0	233	200	3000	3000

VERSIONS

Description	Fibres number	Article No.	Article No.	Article No.
wbGGFR Combi 1 x 2 + 3 x 2.5 mm ²	2	E9/125 G.652.D 186358	G50/125 OM2 187348	G62.5/125 OM1 186366

Product overview and selection guide for fibre optic outdoor cables

Selection criteria

The Datwyler product portfolio consists of many different cable types.

The following overview lists some of the more important criteria which will help you to decide for the cable types that meet your specific requirements.

Cable name Datwyler / DIN VDE page

				Cable characteristics										Laying			Application																																																																																																																																																																																																																																																																																													
				Maximum number of fibres	Robust cable design	Lightweight construction	Rodent protection	Rodent security	Metal-free (no potential differences)	Dry interstices	Longitudinal water blocking	Halogen free sheath	Loose tube	Micro bundle	Installation with cable winches	Blowing through thermoplastic ducts	Laying in cable trays	WAN / City network	Campus / Access network																																																																																																																																																																																																																																																																																											
Fibre optic HighP cables																					FO Outdoor wbKT HP / A-DQ(ZN)B2Y	HighP	220	144	●				●	●	●	●	●	●		●	●	●	●	●	FO Outdoor ZGGT HP / A-DQ(ZN)B2Y	HighP	222	24	●	●			●	●	●	●	●	●		●	●	●	●	●	FO Outdoor wbGGT HP / A-DQ(ZN)B2Y	HighP	224	288	●	●			●	●	●	●	●	●		●	●	●	●	●	FO Outdoor wbGGT HP / A-DQ(ZN)B2Y	HighP, 2-layer	226	576	●	●			●	●	●	●	●	●		●	●	●	●	●	FO Outdoor wbKWT HP / A-DQ(ZN)(SR)2Y	HighP	228	60	●			●	●	●	●	●	●	●		●	●	●	●	●	Fibre optic Basic Line cables																					FO Outdoor ZGGT BL / A-DQ(ZN)B2Y	Basic Line	230	24	●	●			●	●	●	●	●	●		●	●	●	●	●	FO Outdoor wbGGT BL / A-DQ(ZN)B2Y	Basic Line	232	60	●	●			●	●	●	●	●	●		●	●	●	●	●	FO Outdoor ZwbKWT BL / A-DQ(ZN)(SR)2Y	Basic Line	234	24	●	●			●	●	●	●	●	●		●	●	●	●	●	Fibre optic Micro / S-Micro cables																					FO Outdoor ZT S-Micro / A-D2Y	up to 24 fibres	236	24	●				●	●	●	●	●	●		●	●	●	●	●	FO Outdoor ZKT Micro / A-DQ(ZN)2Y	up to 24 fibres	237	24	●				●	●	●	●	●	●		●	●	●	●	●	FO Outdoor wbKT Micro / A-DQ(ZN)2Y	up to 144 fibres	238	144	●				●	●	●	●	●	●		●	●	●	●	●	FO Outdoor wbKT S-Micro / A-DQ(ZN)2Y	up to 216 fibres	240	216	●				●	●	●	●	●	●		●	●	●	●	●
FO Outdoor wbKT HP / A-DQ(ZN)B2Y	HighP	220	144	●				●	●	●	●	●	●		●	●	●	●	●																																																																																																																																																																																																																																																																																											
FO Outdoor ZGGT HP / A-DQ(ZN)B2Y	HighP	222	24	●	●			●	●	●	●	●	●		●	●	●	●	●																																																																																																																																																																																																																																																																																											
FO Outdoor wbGGT HP / A-DQ(ZN)B2Y	HighP	224	288	●	●			●	●	●	●	●	●		●	●	●	●	●																																																																																																																																																																																																																																																																																											
FO Outdoor wbGGT HP / A-DQ(ZN)B2Y	HighP, 2-layer	226	576	●	●			●	●	●	●	●	●		●	●	●	●	●																																																																																																																																																																																																																																																																																											
FO Outdoor wbKWT HP / A-DQ(ZN)(SR)2Y	HighP	228	60	●			●	●	●	●	●	●	●		●	●	●	●	●																																																																																																																																																																																																																																																																																											
Fibre optic Basic Line cables																					FO Outdoor ZGGT BL / A-DQ(ZN)B2Y	Basic Line	230	24	●	●			●	●	●	●	●	●		●	●	●	●	●	FO Outdoor wbGGT BL / A-DQ(ZN)B2Y	Basic Line	232	60	●	●			●	●	●	●	●	●		●	●	●	●	●	FO Outdoor ZwbKWT BL / A-DQ(ZN)(SR)2Y	Basic Line	234	24	●	●			●	●	●	●	●	●		●	●	●	●	●	Fibre optic Micro / S-Micro cables																					FO Outdoor ZT S-Micro / A-D2Y	up to 24 fibres	236	24	●				●	●	●	●	●	●		●	●	●	●	●	FO Outdoor ZKT Micro / A-DQ(ZN)2Y	up to 24 fibres	237	24	●				●	●	●	●	●	●		●	●	●	●	●	FO Outdoor wbKT Micro / A-DQ(ZN)2Y	up to 144 fibres	238	144	●				●	●	●	●	●	●		●	●	●	●	●	FO Outdoor wbKT S-Micro / A-DQ(ZN)2Y	up to 216 fibres	240	216	●				●	●	●	●	●	●		●	●	●	●	●																																																																																																																									
FO Outdoor ZGGT BL / A-DQ(ZN)B2Y	Basic Line	230	24	●	●			●	●	●	●	●	●		●	●	●	●	●																																																																																																																																																																																																																																																																																											
FO Outdoor wbGGT BL / A-DQ(ZN)B2Y	Basic Line	232	60	●	●			●	●	●	●	●	●		●	●	●	●	●																																																																																																																																																																																																																																																																																											
FO Outdoor ZwbKWT BL / A-DQ(ZN)(SR)2Y	Basic Line	234	24	●	●			●	●	●	●	●	●		●	●	●	●	●																																																																																																																																																																																																																																																																																											
Fibre optic Micro / S-Micro cables																					FO Outdoor ZT S-Micro / A-D2Y	up to 24 fibres	236	24	●				●	●	●	●	●	●		●	●	●	●	●	FO Outdoor ZKT Micro / A-DQ(ZN)2Y	up to 24 fibres	237	24	●				●	●	●	●	●	●		●	●	●	●	●	FO Outdoor wbKT Micro / A-DQ(ZN)2Y	up to 144 fibres	238	144	●				●	●	●	●	●	●		●	●	●	●	●	FO Outdoor wbKT S-Micro / A-DQ(ZN)2Y	up to 216 fibres	240	216	●				●	●	●	●	●	●		●	●	●	●	●																																																																																																																																																																																																										
FO Outdoor ZT S-Micro / A-D2Y	up to 24 fibres	236	24	●				●	●	●	●	●	●		●	●	●	●	●																																																																																																																																																																																																																																																																																											
FO Outdoor ZKT Micro / A-DQ(ZN)2Y	up to 24 fibres	237	24	●				●	●	●	●	●	●		●	●	●	●	●																																																																																																																																																																																																																																																																																											
FO Outdoor wbKT Micro / A-DQ(ZN)2Y	up to 144 fibres	238	144	●				●	●	●	●	●	●		●	●	●	●	●																																																																																																																																																																																																																																																																																											
FO Outdoor wbKT S-Micro / A-DQ(ZN)2Y	up to 216 fibres	240	216	●				●	●	●	●	●	●		●	●	●	●	●																																																																																																																																																																																																																																																																																											

Copper

Fibre Optics

Cabinets & Racks

Data Centre

Wireless

Multimedia

General Information

FIBRE OPTIC OUTDOOR CABLES

FO Outdoor wbKT HP / A-DQ(ZN)2Y

HighP

metal-free, dry interstices,
non-armoured, longitudinally watertight

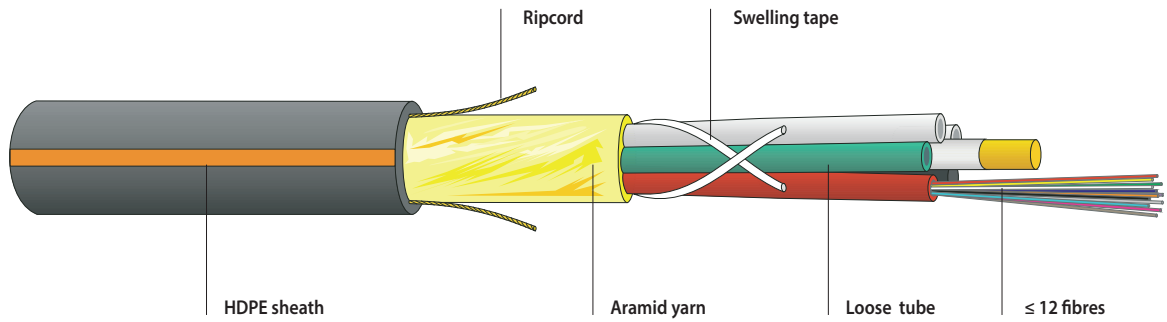

PRODUCT INFORMATION



FEATURES

Compact, metal-free fibre optic outdoor cable with stranded loose tubes. Water blocking elements in the strand interstices prevent water penetration. Easy handling due to lightweight construction. The two coloured ripcords are easy to identify and enable the safe opening of the cable sheath. HDPE cable sheath, easy to lay.

APPLICATION

For pulling in or blowing through thermoplastic duct systems. Suitable for laying in cable platforms and cable trays. Direct burial.

OPTICAL CHARACTERISTICS

The cables are available with different types of optical fibre (see fibre data sheets).

MECHANICAL CHARACTERISTICS

Temperature range	storage:	-40 / +70°C	IEC 60794-1-2 F1
	during installation:	-10 / +50°C	
	in operation:	-40 / +60°C	
Tensile performance:	IEC 60794-1-2 E1		
Crush resistance:	IEC 60794-1-2 E3		
Impact:	IEC 60794-1-2 E4		
Repeated bending:	IEC 60794-1-2 E6		
Torsion:	IEC 60794-1-2 E7		
Bend:	IEC 60794-1-2 E11		
Water penetration:	IEC 60794-1-2 F5		

GENERAL CHARACTERISTICS

Imprint: DATWYLER «cable type» «Datwyler designation» «DIN designation» «number of fibres» «fibre type» «additional text» «batch number»
 ~ ~ «meter marks» ~ ~
 Zero halogen, non corrosive gases
 IEC 60754-1/-2, EN 50267-2-1/2-2, VDE 0482-267-2-1/-2-2

- Copper
- Fibre Optics
- Cabinets & Racks
- Data Centre
- Wireless
- Multimedia
- General Information

GF-1301 wbKT HighP 07/14/e

FIBRE OPTIC OUTDOOR CABLES
FO Outdoor wbKT HP / A-DQ(ZN)2Y
HighP

metal-free, dry interstices,
 non-armoured, longitudinally watertight

PRODUCT INFORMATION

Description	No. of fibres		Loose tubes	Sheath Ø	Weight	Bending radius	Tensile load	Crush resistance		Fire load	
	max.	max.						mm	kg/km	mm	N
A-DQ(ZN)2Y n x m											
wbKT5 HighP	60	5	10.2	74	155	3000	1000	3000	748	2693	
wbKT6 HighP	72	6	11.0	91	165	3000	1000	3000	843	3035	
wbKT8 HighP	96	8	12.5	121	190	3000	1000	3000	1010	3640	
wbKT10 HighP	120	10	14.0	150	210	3000	1000	3000	1185	4270	
wbKT12 HighP	144	12	15.6	187	235	3000	1000	3000	1390	5004	

VERSIONS

A-DQ(ZN)2Y n x m		Fibres	Article No.
Description		number	E9/125 G.652.D
wbKT5 HighP	1 x 12	12	190661
wbKT5 HighP	2 x 12	24	190662
wbKT5 HighP	4 x 12	48	190160
wbKT5 HighP	5 x 12	60	190161
wbKT6 HighP	6 x 12	72	190162
wbKT8 HighP	8 x 12	96	190163
wbKT12 HighP	10 x 12	120	190164
wbKT12 HighP	12 x 12	144	190165

FIBRE OPTIC OUTDOOR CABLES

FO Outdoor ZGGT HP / A-DQ(ZN)B2Y

HighP

central tube design, metal-free,
longitudinally watertight, rodent protection

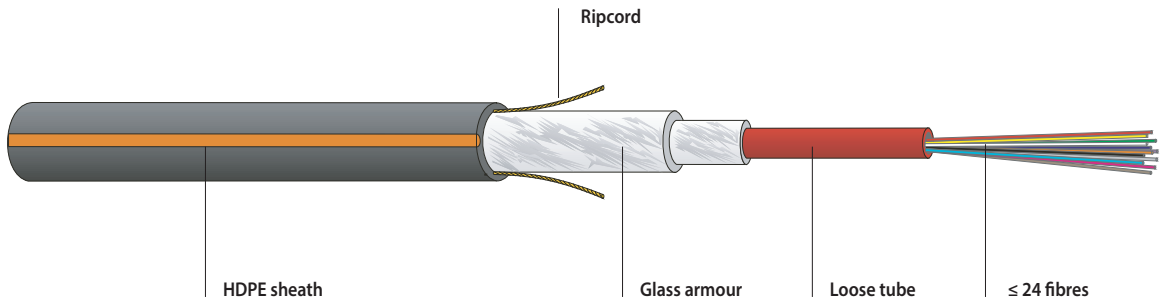

PRODUCT INFORMATION



FEATURES

Robust, metal-free fibre optic outdoor cable with one central loose tube and up to 24 fibres. High tensile strength and high radial load strength for the highest transmission security. Lightweight and installation friendly cable construction. Non-metallic rodent protection. The two coloured ripcords are easy to identify and enable the safe opening of the cable sheath. HDPE cable sheath, easy to lay.

APPLICATION

For pulling in or blowing through thermoplastic duct systems. Suitable for laying in cable platforms, cable shafts and even in very complex cable trays. Direct burial.

OPTICAL CHARACTERISTICS

The cables are available with different types of optical fibre (see fibre data sheet).

MECHANICAL CHARACTERISTICS

Temperature range	storage:	-40 / +70°C	IEC 60794-1-2 F1
	during installation:	-10 / +50°C	
	in operation:	-40 / +60°C	
Tensile performance:	IEC 60794-1-2 E1		
Crush resistance:	IEC 60794-1-2 E3		
Impact:	IEC 60794-1-2 E4		
Repeated bending:	IEC 60794-1-2 E6		
Torsion:	IEC 60794-1-2 E7		
Bend:	IEC 60794-1-2 E11		
Water penetration:	IEC 60794-1-2 F5		

GENERAL CHARACTERISTICS

Imprint: DATWYLER «cable type» «Datwyler designation» «DIN designation» «number of fibres» «fibre type» «additional text» «batch number»
~ ~ «meter marks» ~ ~

 Zero halogen,
non corrosive gases

IEC 60754-1/-2, EN 50267-2-1/2-2, VDE 0482-267-2-1/-2-2

Copper

Fibre Optics

Cabinets & Racks

Data Centre

Wireless

Multimedia

General Information

GF-1310 ZGGT HighP 0714/e

FIBRE OPTIC OUTDOOR CABLES
FO Outdoor ZGGT HP / A-DQ(ZN)B2Y
HighP

central tube design, metal-free,
longitudinally watertight, rodent protection

PRODUCT INFORMATION

Description	A-DQ(ZN)B2Y 1 x m	No. of fibres max.	Loose tube	Sheath Ø mm	Weight kg/km	Bending radius mm	Tensile load N	Crush resistance		Fire load	
								continuous N	short term N	kWh/km	MJ/km
ZGGT HighP	1 x 12	12	1	8.2	65	130	2500	6000	10000	558	2009
ZGGT HighP	1 x 24	24	1	8.6	70	135	2500	6000	10000	589	2120

VERSIONS

A-DQ(ZN)B2Y 1 x m		Fibres number	Article No. E9/125 G.652.D	Article No. G50/125 OM2	Article No. G50/125 OM3	Article No. G50/125 OM4	Article No. G62,5/125 OM1
Description							
ZGGT HighP	1 x 4	4	190166	186320	192121	–	186379
ZGGT HighP	1 x 6	6	190167	186481	190747	–	186483
ZGGT HighP	1 x 8	8	190168	186480	on request	–	186484
ZGGT HighP	1 x 12	12	190169	185937	186361	192610	185945
ZGGT HighP	1 x 24	24	190149	186660	192645	192167	on request

FIBRE OPTIC OUTDOOR CABLES

FO Outdoor wbGGT HP / A-DQ(ZN)B2Y

HighP

metal-free, dry interstices,
longitudinally watertight, rodent protection

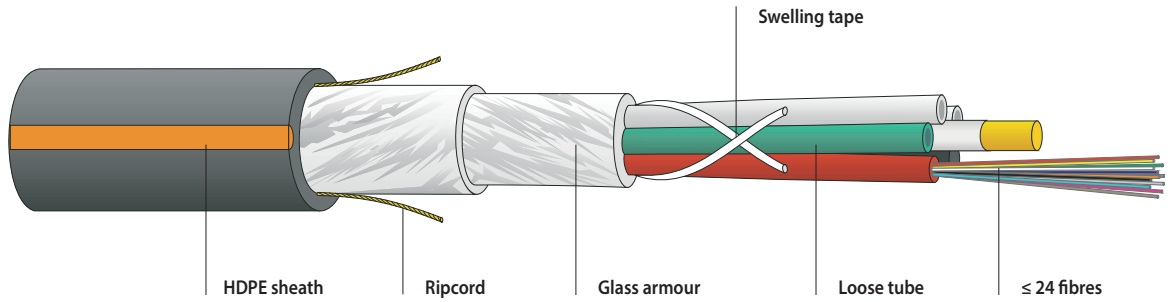

PRODUCT INFORMATION



FEATURES

Robust, metal-free fibre optic outdoor cable with stranded loose tubes in one layer.
High crush resistance for high transmission reliability.
Easy handling due to the use of dry strand interstices.
Non-metallic rodent protection.
The two coloured ripcords are easy to identify and enable the safe opening of the cable sheath.
HDPE cable sheath, easy to lay.

APPLICATION

For pulling in or blowing through thermoplastic duct systems.
Suitable for laying in cable platforms, cable trays and even in complex cable trays.
Direct burial.

OPTICAL CHARACTERISTICS

The cables are available with different types of optical fibre (see fibre data sheet) that can also be combined in one cable.

MECHANICAL CHARACTERISTICS

Temperature range	storage:	-40 / +70°C	IEC 60794-1-2 F1
	during installation:	-10 / +50°C	
	in operation:	-40 / +60°C	
Tensile performance:		IEC 60794-1-2 E1	
Crush resistance:		IEC 60794-1-2 E3	
Impact:		IEC 60794-1-2 E4	
Repeated bending:		IEC 60794-1-2 E6	
Torsion:		IEC 60794-1-2 E7	
Bend:		IEC 60794-1-2 E11	
Water penetration:		IEC 60794-1-2 F5	

GENERAL CHARACTERISTICS

Imprint: DATWYLER «cable type» «Datwyler designation» «DIN designation»
«number of fibres» «fibre type» «additional text» «batch number»
~ ~ «meter marks» ~ ~

 Zero halogen,
non corrosive gases

IEC 60754-1/-2, EN 50267-2-1/2-2, VDE 0482-267-2-1/-2-2

FO Outdoor wbGGT HP / A-DQ(ZN)B2Y

HighP

metal-free, dry interstices,
longitudinally watertight, rodent protection

PRODUCT INFORMATION

Description	No. of fibres	Loose tubes	Sheath Ø	Weight	Bending radius	Tensile load	Crush resistance		Fire load	
A-DQ(ZN)B2Y n x m			mm	kg/km	mm	N	continuous N	short term N	kWh/km	MJ/km
wbGGT5 HighP 5 x 12	60	5	12.0	128	180	9000	3000	8000	1040	3744
wbGGT6 HighP 6 x 12	72	6	12.8	146	195	9000	3000	8000	1137	4093
wbGGT8 HighP 8 x 12	96	8	14.0	160	210	9000	3000	8000	1305	4699
wbGGT10 HighP 10 x 12	120	10	15.4	190	230	9000	3000	8000	1491	5365
wbGGT12 HighP 12 x 12	144	12	16.9	223	255	9000	3000	8000	1707	6145
wbGGT6 HighP 6 x 24	144	6	13.8	167	205	9000	3000	8000	1291	4655
wbGGT8 HighP 8 x 24	192	8	15.0	190	225	9000	3000	8000	1583	5704
wbGGT10 HighP 9 x 24	216	10	17.0	250	255	9000	3000	8000	1993	7175
wbGGT12 HighP 12 x 24	288	12	18.8	273	285	9000	3000	8000	2453	8832

VERSIONS

A-DQ(ZN)B2Y n x m	Fibres	Article No.	Article No.	Article No.	Article No
Description	number	E9/125 G.652.D	G50/125 OM2	G50/125 OM3	G62.5/125 OM1
wbGGT5 HighP 1 x 12	12	190059	186627	190651	186455
wbGGT5 HighP 2 x 12	24	186748	186437	190368	186399
wbGGT5 HighP 3 x 12	36	190058	186438	on request	186457
wbGGT5 HighP 4 x 12	48	187385	186439	190369	186458
wbGGT5 HighP 5 x 12	60	190171	on request	on request	191838
wbGGT6 HighP 6 x 12	72	190172	191782	on request	on request
wbGGT8 HighP 8 x 12	96	186760	190372	on request	on request
wbGGT10 HighP 10 x 12	120	190175	on request	192697	on request
wbGGT12 HighP 12 x 12	144	187394	on request	190311	on request
wbGGT6 HighP 6 x 24	144	190764	on request	on request	on request
wbGGT8 HighP 8 x 24	192	191270	on request	on request	on request
wbGGT10 HighP 9 x 24	216	190696	on request	on request	on request
wbGGT12 HighP 12 x 24	288	190325	on request	on request	on request

FIBRE OPTIC OUTDOOR CABLES

FO Outdoor wbGGT HP / A-DQ(ZN)B2Y

HighP, 2-layer

metal-free, dry interstices,
longitudinally watertight, rodent protection

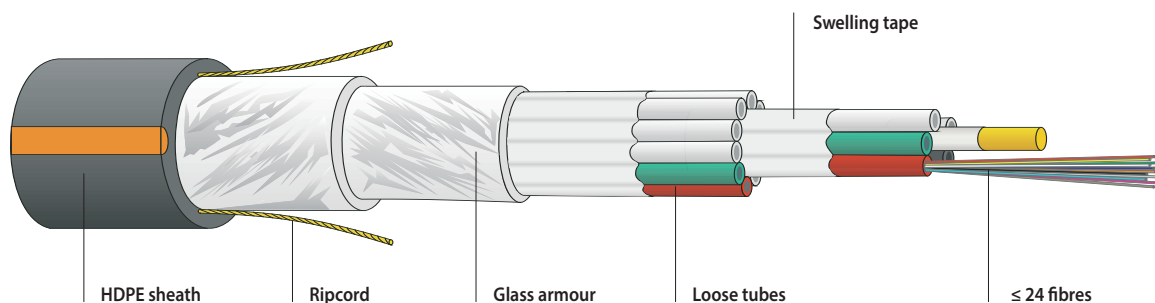

PRODUCT INFORMATION



FEATURES

Compact fibre optic outdoor cable with up to 576 fibres for city and access networks. 2-layer loose tube construction, longitudinally water protected and with dry strand interstices. The glass armour provides for a combined non-metallic rodent protection and strain relief. The two coloured ripcords are easy to identify and enable the safe opening of the cable sheath. HDPE cable sheath, easy to lay. Direct burial.

APPLICATION

Optimised for blowing into compact thermoplastic ducts.

OPTICAL CHARACTERISTICS

The cables are available with different types of optical fibre (see fibre data sheet) that can also be combined in one cable.

MECHANICAL CHARACTERISTICS

Temperature range	storage:	-40 / +70°C	IEC 60794-1-2 F1
	during installation:	-10 / +50°C	
	in operation:	-40 / +60°C	
Tensile performance:		IEC 60794-1-2 E1	
Crush resistance:		IEC 60794-1-2 E3	
Repeated bending:		IEC 60794-1-2 E6	
Torsion:		IEC 60794-1-2 E7	
Bend:		IEC 60794-1-2 E11	
Water penetration:		IEC 60794-1-2 F5	

GENERAL CHARACTERISTICS

Imprint: DATWYLER «cable type» «Datwyler designation» «DIN designation» «number of fibres» «fibre type» «additional text» «batch number»
~ ~ «meter marks» ~ ~

 Zero halogen,
non corrosive gases

IEC 60754-1/-2, EN 50267-2-1/2-2, VDE 0482-267-2-1/-2-2

FO Outdoor wbGGT HP / A-DQ(ZN)B2Y

HighP, 2-layer

metal-free, dry interstices,
longitudinally watertight, rodent protection

PRODUCT INFORMATION

Description	No. of fibres	Loose tubes	Sheath Ø	Weight	Bending radius	Tensile load	Crush resistance		Fire load	
							continuous N	short term N	kWh/km	MJ/km
A-DQ(ZN)B2Y n x m	max.	max.	mm	kg/km	mm	N				
wbGGT18 HighP	180	18	18.5	285	470	9000	3000	5000	2492	7967
wbGGT18 HighP	216	18	18.5	285	470	9000	3000	5000	2492	7967
woGGT24 HighP	288	24	22.0	375	550	9000	3000	5000	2568	9245
wbGGT18 HighP	432	18	20.6	335	515	9000	3000	5000	3115	11214
woGGT24 HighP	576	24	22.0	643	705	9000	3000	5000	4786	15123

VERSIONS

A-DQ(ZN)B2Y n x m		Fibres number	Article No.
Description			
wbGGT18 HighP	15 x 12	180	190709
wbGGT18 HighP	16 x 12	192	190699
wbGGT18 HighP	18 x 12	216	190176
wbGGT24 HighP	20 x 12	240	191693
wbGGT24 HighP	24 x 12	288	190399
wbGGT18 HighP	18 x 24	432	190178
wbGGT24 HighP	24 x 24	576	190700

FIBRE OPTIC OUTDOOR CABLES

FO Outdoor wbKWT HP / A-DQ(ZN)(SR)2Y

HighP

dry interstices, longitudinally watertight,
corrugated steel tape, rodent proof

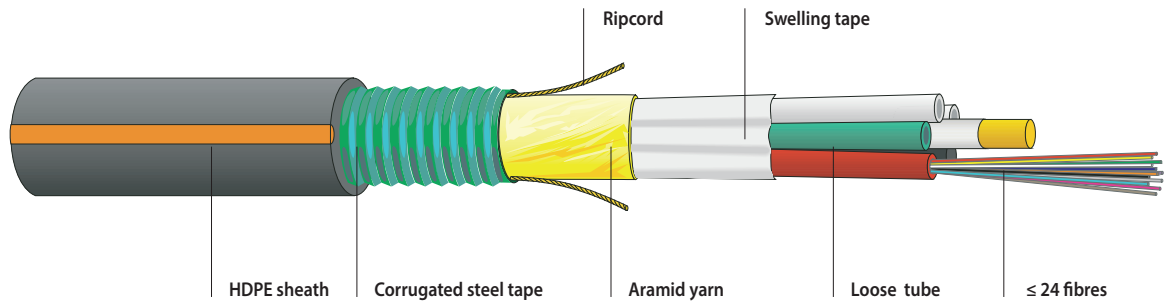

PRODUCT INFORMATION



FEATURES

Robust fibre optic outdoor cable with multiple loose tubes.
Installation friendly dry construction.
Rodent proof due to corrugated steel tape.
High tensile strength, easy to lay.
Optimised for installation in and blowing into ducts.

APPLICATION

For pulling in or blowing through ducts.
Suitable for laying in cable platforms, cable shafts and even in complex cable trays, particularly where a reliable rodent protection is required.
Direct burial.

OPTICAL CHARACTERISTICS

The cables are available with different types of optical fibre (see fibre data sheets).

MECHANICAL CHARACTERISTICS

Temperature range	storage:	-40 / +70°C	IEC 60794-1-2 F1
	during installation:	-10 / +50°C	
	in operation:	-40 / +60°C	
Tensile performance:	IEC 60794-1-2 E1		
Crush resistance:	IEC 60794-1-2 E3		
Impact:	IEC 60794-1-2 E4		
Repeated bending:	IEC 60794-1-2 E6		
Torsion:	IEC 60794-1-2 E7		
Bend:	IEC 60794-1-2 E11		
Water penetration:	IEC 60794-1-2 F5		

GENERAL CHARACTERISTICS

Imprint: DATWYLER «cable type» «Datwyler designation» «DIN designation»
«number of fibres» «fibre type» «additional text» «batch number»
~ ~ «meter marks» ~ ~

 Zero halogen,
non corrosive gases

IEC 60754-1/-2, EN 50267-2-1/2-2, VDE 0482-267-2-1/-2-2

- Copper
- Fibre Optics
- Cabinets & Racks
- Data Centre
- Wireless
- Multimedia
- General Information

GF-1308 wbKWT HighP 0714/e

FO Outdoor wbKWT HP / A-DQ(ZN)(SR)2Y

HighP

dry interstices, longitudinally watertight,
corrugated steel tape, rodent proof

PRODUCT INFORMATION

Description	No. of fibres	Loose tubes	Sheath Ø	Weight	Bending radius	Tensile load	Crush resistance		Fire load	
A-DQ(ZN)(SR)2Y n x m	max.	max.	mm	kg/km	mm	N	continuous N	short term N	kWh/km	MJ/km
wbKWT6 HighP	72	5	13.4	150	200	2500	1500	4000	1019	3668
wbKWT6 HighP	144	6	13.6	171	205	2500	1500	4000	1094	3852

VERSIONS

A-DQ(ZN)(SR)2Y n x m	Fibres	Article No.	Article No.	Article No.	Article No.
Description	number	E9/125 G.652D	G50/125 OM2	G50/125 OM3	G62.5/125 OM1
wbKWT5 HighP 2 x 12	24	190184	180761	on request	180172
wbKWT5 HighP 4 x 12	48	190185	on request	193398	181794
wbKWT5 HighP 5 x 12	60	186590	on request	on request	on request
wbKWT6 HighP 6 x 12	72	190650	on request	on request	on request
wbKWT6 HighP 4 x 24	96	191698	on request	on request	on request
wbKWT6 HighP 6 x 24	144	191197	on request	on request	on request

FIBRE OPTIC OUTDOOR CABLES

FO Outdoor ZGGT BL / A-DQ(ZN)B2Y

Basic Line

central loose tube, metal-free,
longitudinally watertight, rodent protection

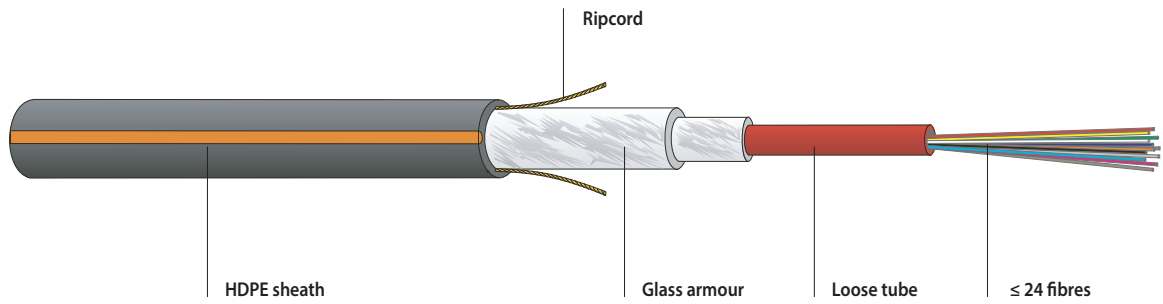

PRODUCT INFORMATION



FEATURES

Metal-free fibre optic outdoor cable with central loose tube, up to 24 fibres.
For the use in cable ducts and for all applications with low mechanical stress (low tensile force, for example).
Non-metallic rodent protection.

APPLICATION

For pulling in or blowing through ducts.
Suitable for laying in cable platforms and cable shafts/trays.
Direct burial.

OPTICAL CHARACTERISTICS

The cables are available with different types of optical fibre (see fibre data sheets).

MECHANICAL CHARACTERISTICS

Temperature range	storage:	-25 / +70°C	IEC 60794-1-2 F1
	during installation:	-10 / +50°C	
	in operation:	-25 / +60°C	
Tensile performance:	IEC 60794-1-2 E1		
Crush resistance:	IEC 60794-1-2 E3		
Impact:	IEC 60794-1-2 E4		
Repeated bending:	IEC 60794-1-2 E6		
Torsion:	IEC 60794-1-2 E7		
Bend:	IEC 60794-1-2 E11		
Water penetration:	IEC 60794-1-2 F5		

GENERAL CHARACTERISTICS

Imprint: DATWYLER «cable type» «Datwyler designation» «DIN designation»
«number of fibres» «fibre type» «additional text» «batch number»
~ ~ «meter marks» ~ ~
Zero halogen, non corrosive gases
IEC 60754-1/-2, EN 50267-2-1/2-2, VDE 0482-267-2-1/-2-2

Copper

Fibre Optics

Cabinets & Racks

Data Centre

Wireless

Multimedia

General Information

GF-1311 ZGGT 1000 BL 0714/e

FIBRE OPTIC OUTDOOR CABLES
FO Outdoor ZGGT BL / A-DQ(ZN)B2Y

Basic Line

central loose tube, metal-free,
longitudinally watertight, rodent protection

PRODUCT INFORMATION

Description	No. of fibres	Loose tube	Sheath Ø	Weight	Bending radius	Tensile load	Crush resistance		Fire load	
A-DQ(ZN)B2Y 1 x m	max.		mm	kg/km	mm	N	continuous N	short term N	kWh/km	MJ/km
ZGGT Basic Line 1 x 12	12	1	7.3	48	110	1000	2000	5000	418	1505
ZGGT Basic Line 1 x 24	24	1	8.0	55	120	1000	2000	5000	491	1768

VERSIONS

A-DQ(ZN)B2Y 1 x m	Fibres	Article No.	Article No.	Article No.	Article No.	Article No.
Description	number	E9/125 G.657.A1	E9/125 G.652.D	G50/125 OM2	G50/125 OM3	G62,5/125 OM1
ZGGT Basic Line 1 x 2	2	–	–	190060	–	–
ZGGT Basic Line 1 x 4	4	–	191292	185557	on request	–
ZGGT Basic Line 1 x 6	6	–	191256	191259	191188	186497
ZGGT Basic Line 1 x 8	8	–	186500	–	–	–
ZGGT Basic Line 1 x 12	12	192626	190192	186499	191190	187350
ZGGT Basic Line 1 x 24	24	–	190193	186365	on request	186643

FIBRE OPTIC OUTDOOR CABLES

FO Outdoor wbGGT BL / A-DQ(ZN)B2Y

Basic Line

metal-free, dry interstices,
longitudinally watertight, rodent protection

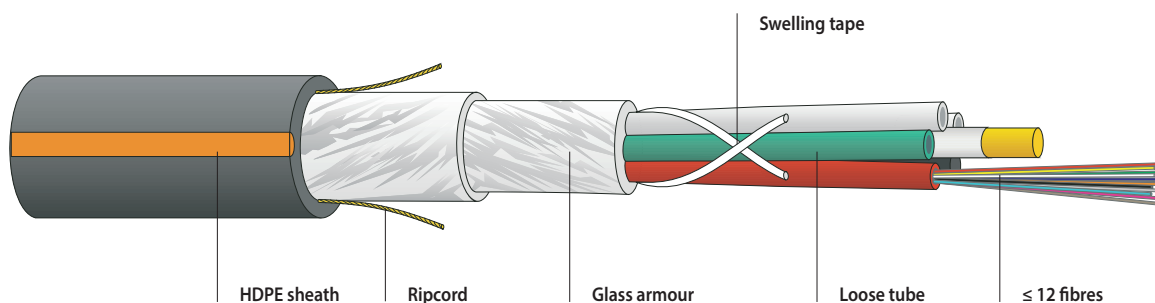

PRODUCT INFORMATION



FEATURES Compact metal-free fibre optic outdoor cable with stranded loose tubes, up to 60 fibres.

APPLICATION Pulling in or blowing through thermoplastic ducts.
Laying in cable platforms, shafts and trays with low mechanical stress.
Direct burial.

OPTICAL CHARACTERISTICS The cables are available with different types of optical fibre (see fibre data sheets).

MECHANICAL CHARACTERISTICS	Temperature range	storage:	-25 / +60°C	IEC 60794-1-2 F1
		during installation:	-10 / +40°C	
		in operation:	-25 / +60°C	
	Tensile performance:	IEC 60794-1-2 E1		
	Crush resistance:	IEC 60794-1-2 E3		
	Repeated bending:	IEC 60794-1-2 E6		
	Torsion:	IEC 60794-1-2 E7		
	Bend:	IEC 60794-1-2 E11		
	Water penetration:	IEC 60794-1-2 F5		

GENERAL CHARACTERISTICS Imprint: DATWYLER «cable type» «Datwyler designation» «DIN designation» «number of fibres» «fibre type» «additional text» «batch number» ~ ~ «meter marks» ~ ~

 Zero halogen,
non corrosive gases

IEC 60754-1/-2, EN 50267-2-1/2-2, VDE 0482-267-2-1/-2-2

FO Outdoor wbGGT BL / A-DQ(ZN)B2Y

Basic Line

metal-free, dry interstices,
longitudinally watertight

PRODUCT INFORMATION

Description	No. of fibres	Loose tubes	Sheath Ø	Weight	Bending radius	Tensile load	Crush resistance			Fire load	
A-DQ(ZN)B2Y n x m	max.	max.	mm	kg/km	mm	N	continuous N	short term N/	kWh/km	MJ/km	
wbGGT5 Basic Line 5 x 12	60	5	9.4	68	141	3000	1500	2500	606	2182	

VERSIONS

A-DQ(ZN)B2Y n x m	Fibres	Article No.
Description	number	E9/125 G.652.D
wbGGT5 Basic Line 1 x 12	12	186591
wbGGT5 Basic Line 2 x 12	24	190092
wbGGT5 Basic Line 3 x 12	36	190752
wbGGT5 Basic Line 4 x 12	48	190194
wbGGT5 Basic Line 5 x 12	60	190195

FIBRE OPTIC OUTDOOR CABLES

FO Outdoor ZwbKWT BL / A-DQ(ZN)(SR)2Y

Basic Line

central loose tube, longitudinally watertight,
corrugated steel tape, rodent proof

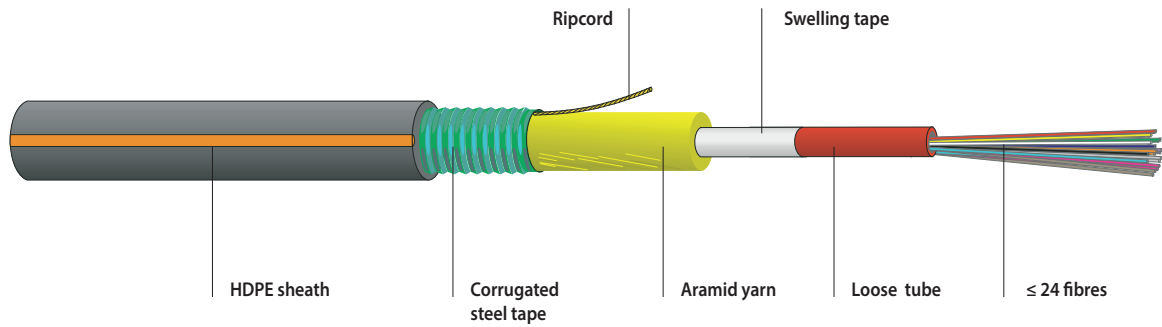

PRODUCT INFORMATION



FEATURES

Fibre optic outdoor cable with corrugated steel tape for optimal rodent protection.
Central loose tube, up to 24 fibres.
Dry construction.
Stable laying characteristics, easy installation in ducts.

APPLICATION

Installation in thermoplastic ducts.
Suitable for laying in cable platforms, cable shafts and even in complex cable trays, particularly where a reliable rodent protection is required.
Direct burial.

OPTICAL CHARACTERISTICS

The cables are available with different types of fibre (see fibre data sheets).

MECHANICAL CHARACTERISTICS

Temperature range	storage:	-40 / +70°C	IEC 60794-1-2 F1
	during installation:	-10 / +50°C	
	in operation:	-40 / +60°C	
Tensile performance:	IEC 60794-1-2 E1		
Crush resistance:	IEC 60794-1-2 E3		
Impact:	IEC 60794-1-2 E4		
Repeated bending:	IEC 60794-1-2 E6		
Torsion:	IEC 60794-1-2 E7		
Bend:	IEC 60794-1-2 E11		
Water penetration:	IEC 60794-1-2 F5		

GENERAL CHARACTERISTICS

Imprint: DATWYLER «cable type» «Datwyler designation» «DIN designation»
«number of fibres» «fibre type» «additional text» «batch number»
~ ~ «meter marks» ~ ~

 Zero halogen,
non corrosive gases

IEC 60754-1/-2, EN 50267-2-1/2-2, VDE 0482-267-2-1/-2-2

FO Outdoor ZwbKWT BL / A-DQ(ZN)(SR)2Y

Basic Line

central loose tube, longitudinally watertight,
corrugated steel tape, rodent proof

PRODUCT INFORMATION

Description	No. of fibres	Loose tube	Sheath Ø	Weight	Bending radius	Tensile load	Crush resistance		Fire load	
A-DQ(ZN)(SR)2Y 1 x m			mm	kg/km	mm	N	continuous N	short term N	kWh/km	MJ/km
ZwbKWT Basic Line 1 x 12	12	1	8.2	69	120	1000	1500	4000	603	2171
ZwbKWT Basic Line 1 x 24	24	1	8.2	85	120	1000	1500	4000	629	2264

VERSIONS

A-DQ(ZN)(SR)2Y 1 x m	Fibres	Article No.	Article No.	Article No.	Article No.	Article No.
Description	number	E9/125 G.652.D	G50/125 OM2	G50/125 OM3	G50/125 OM4	G62.5/125 OM1
ZwbKWT Basic Line 1 x 2	2	–	184208	–	–	184199
ZwbKWT Basic Line 1 x 4	4	190200	180171	on request	on request	178872
ZwbKWT Basic Line 1 x 6	6	187377	184200	187389	on request	178873
ZwbKWT Basic Line 1 x 8	8	190201	178732	190072	on request	178773
ZwbKWT Basic Line 1 x 12	12	190202	180114	191806	192689	176522
ZwbKWT Basic Line 1 x 16	16	–	–	190040	–	186342
ZwbKWT Basic Line 1 x 24	24	190355	186630	on request	on request	186623

FIBRE OPTIC OUTDOOR CABLES

FO Outdoor ZT S-Micro / A-D2Y

S-Micro, up to 24 fibres

metal-free, non-armoured, dry interstices, longitudinally watertight

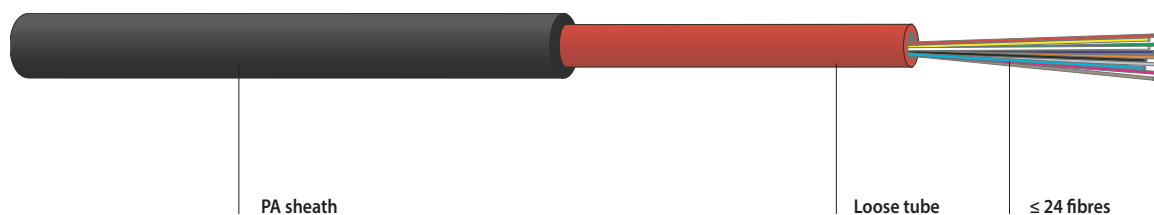

PRODUCT INFORMATION



FEATURES

Very thin, metal-free fibre optic outdoor cable with up to 24 fibres in one central loose tube. Easily cut back, installation friendly cable construction.

APPLICATION

FTTx, Fibre-to-the-home networks. Optimised for injection into microducts.

OPTICAL CHARACTERISTICS

The standard version of this cable is available with single-mode fiber according to ITU G.657A1.

MECHANICAL CHARACTERISTICS

Temperature range	storage:	-25 / +70°C	IEC 60794-1-2 F1
	during installation/injection:	-2 / +35°C	
	in operation:	-25 / +60°C	
Tensile performance:		IEC 60794-1-2 E1	
Crush resistance:		IEC 60794-1-2 E3	
Repeated bending:		IEC 60794-1-2 E6	
Torsion:		IEC 60794-1-2 E7	
Bend:		IEC 60794-1-2 E11	
Water penetration:		IEC 60794-1-2 F5	

GENERAL CHARACTERISTICS

Imprint: DATWYLER «cable type» «Datwyler designation» «DIN designation» «number of fibres» «fibre type» «additional text» «batch number»
 ~ ~ «meter marks» ~ ~
 Recommendation: For the injection we recommend to use special equipment with a soft belt.
 Zero halogen, non corrosive gases IEC 60754-1/-2, EN 50267-2-1/2-2, VDE 0482-267-2-1/-2-2

ACCESSORIES

Please find the appropriate FTTx accessories in the data sheets on our website or in the Datwyler FTTH catalogue.

Description	No. of fibres	Loose tube	Sheath Ø	Weight	Bending radius	Tensile load	Crush resistance		Fire load
A-D2Y n x m			mm	kg/km	mm	N	continuous N	short term N	kWh/km
S-Micro 1 x 4	4	1	2,6	6,5	40	100	400	1200	120
S-Micro 1 x 24	24	1	2,6	6,5	40	100	400	1200	120

VERSIONS

A-D2Y n x m	Fibres	Article No.	Article No.
Description	number	E9/125 G.657.A1	G50/125 OM4
S-Micro 1 x 4	4	193434	-
S-Micro 1 x 12	12	193460	193435
S-Micro 1 x 24	24	193433	-

FO ZT S-Micro 24F 0714/e

Copper

Fibre Optics

Cabinets & Racks

Data Centre

Wireless

Multimedia

General Information

FO Outdoor ZKT Micro / A-DQ(ZN)2Y

Micro, up to 24 fibres

metal-free, non-armoured,
dry interstices, longitudinally watertight

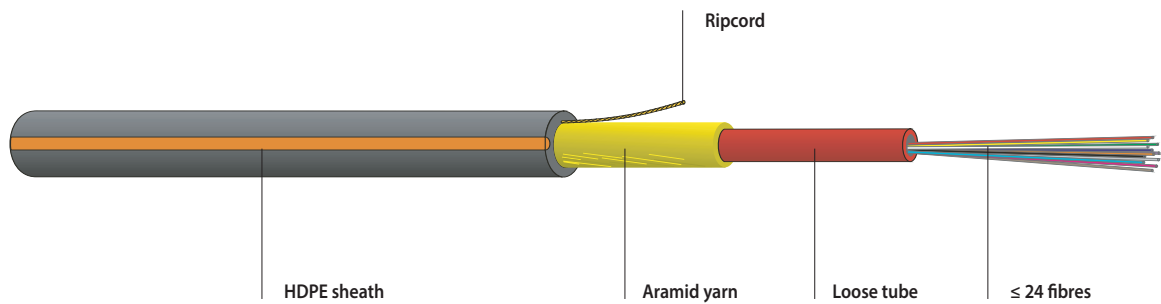

PRODUCT INFORMATION



FEATURES Very thin, metal-free fiber optic outdoor cable with up to 24 fibres in one central loose tube. Easily cut-back, installation friendly cable construction.

APPLICATION FTTx, Fibre-to-the-home networks. Optimised for injection into microducts.

OPTICAL CHARACTERISTICS The cables are available with different types of optical fibre (see fibre data sheets).

MECHANICAL CHARACTERISTICS

Temperature range	storage: -40 / +70°C IEC 60794-1-2 F1
	during installation/injection: -2 / +35°C
	in operation: -40 / +70°C
Tensile performance:	IEC 60794-1-2 E1
Crush resistance:	IEC 60794-1-2 E3
Repeated bending:	IEC 60794-1-2 E6
Torsion:	IEC 60794-1-2 E7
Bend:	IEC 60794-1-2 E11
Water penetration:	IEC 60794-1-2 F5

GENERAL CHARACTERISTICS

Imprint: DATWYLER «cable type» «Datwyler designation» «DIN designation» «number of fibres» «fibre type» «additional text» «batch number»
~ ~ ~ «meter marks» ~ ~ ~

Zero halogen, non corrosive gases IEC 60754-1/-2, EN 50267-2-1/2-2, VDE 0482-267-2-1/-2-2

ACCESSORIES Please find the appropriate FTTx accessories in the data sheets on our website or in the Datwyler FTTH catalogue.

Description	A-DQ(ZN)2Y n x m	No. of fibres	Loose tubes	Sheath Ø	Weight	Bending radius	Tensile load	Crush resistance		Fire load	
								max.	max.	mm	kg/km
Micro ZKT	1 x 24	24	1	4.0	19	100	500	600	1600	165	594

VERSIONS

Description	Fibres	Article No.	Article No.
A-DQ(ZN)2Y n x m	number	E9/125 G.652.D	E9/125 G.657.A1
Micro ZKT 1 x 2	2	191702	-
Micro ZKT 1 x 4	4	190658	-
Micro ZKT 1 x 6	6	191703	-
Micro ZKT 1 x 8	8	191704	-
Micro ZKT 1 x 10	10	191705	-
Micro ZKT 1 x 12	12	190227	191349
Micro ZKT 1 x 24	24	191235	191350

FIBRE OPTIC OUTDOOR CABLES

FO Outdoor wbKT Micro / A-DQ(ZN)2Y

Micro, up to 144 fibres

metal-free, non-armoured,
dry interstices, longitudinally watertight

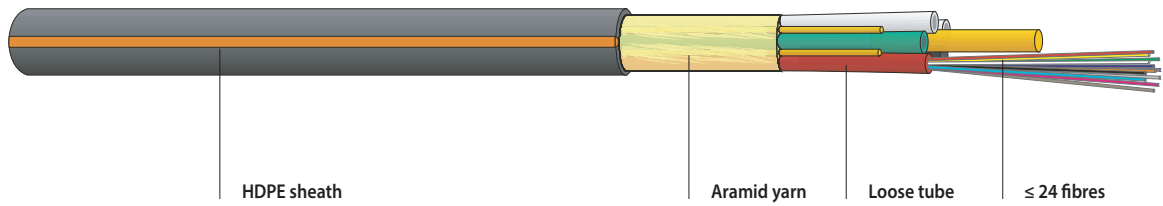

PRODUCT INFORMATION



FEATURES

Very compact, metal-free fibre optic outdoor cable with up to 144 fibres in stranded loose tubes. Easily cut-back, installation friendly cable construction with dry interstices.

APPLICATION

FTTx, Fibre-to-the-home networks.
Optimised for injection into microducts.

OPTICAL CHARACTERISTICS

The cables are available with different types of optical fibre (see fibre data sheets).

MECHANICAL CHARACTERISTICS

Temperature range	storage:	-40 / +70°C IEC 60794-1-2 F1
	during installation/injection:	-2 / +35°C
	in operation:	-40 / +70°C
Tensile performance:	IEC 60794-1-2 E1	
Crush resistance:	IEC 60794-1-2 E3	
Repeated bending:	IEC 60794-1-2 E6	
Torsion:	IEC 60794-1-2 E7	
Bend:	IEC 60794-1-2 E11	
Water penetration:	IEC 60794-1-2 F5	

GENERAL CHARACTERISTICS

Imprint: DATWYLER «cable type» «Datwyler designation» «DIN designation»
«number of fibres» «fibre type» «additional text» «batch number»
~ ~ «meter marks» ~ ~

 Zero halogen,
non corrosive gases

IEC 60754-1/-2, EN 50267-2-1/2-2, VDE 0482-267-2-1/-2-2

ACCESSORIES

Please find the appropriate FTTx accessories in the data sheets on our website or in the Datwyler FTTH catalogue.

FO Outdoor wbKT Micro / A-DQ(ZN)2Y

Micro, up to 144 fibres

metal-free, non-armoured,
dry interstices, longitudinally watertight

PRODUCT INFORMATION

Description A-DQ(ZN)2Y n x m	No. of fibres	Loose tubes	Sheath Ø	Weight	Bending radius	Tensile load	Crush resistance		Fire load	
			mm	kg/km	mm	N	continuous N	short term N	kWh/km	MJ/km
wbKT Micro 5 x 12	60	5	6.6	30	150	1000	600	1600	247	889
wbKT Micro 6 x 12	72	6	6.6	30	150	1000	600	1600	247	889
wbKT Micro 8 x 12	96	8	7.6	54	250	2500	600	1400	303	1092
wbKT Micro 6 x 24	144	6	8.2	60	250	2500	600	1400	344	1238

VERSIONS

Description A-DQ(ZN)2Y n x m	Fibres number	Article No. E9/125 G.652.D	Article No. E9/125 G.657.A1
wbKT Micro 1 x 12	12	191706	on request
wbKT Micro 2 x 12	24	190080	192131
wbKT Micro 3 x 12	36	190229	on request
wbKT Micro 4 x 12	48	190230	191859
wbKT Micro 5 x 12	60	190231	191860
wbKT Micro 6 x 12	72	190232	191858
wbKT Micro 8 x 12	96	191813	192158
wbKT Micro 6 x 24	144	191814	on request

FIBRE OPTIC OUTDOOR CABLES

FO Outdoor wbKT S-Micro / A-DQ(ZN)2Y

S-Micro up to 216 Fasern

metal-free, non-armoured, longitudinally watertight

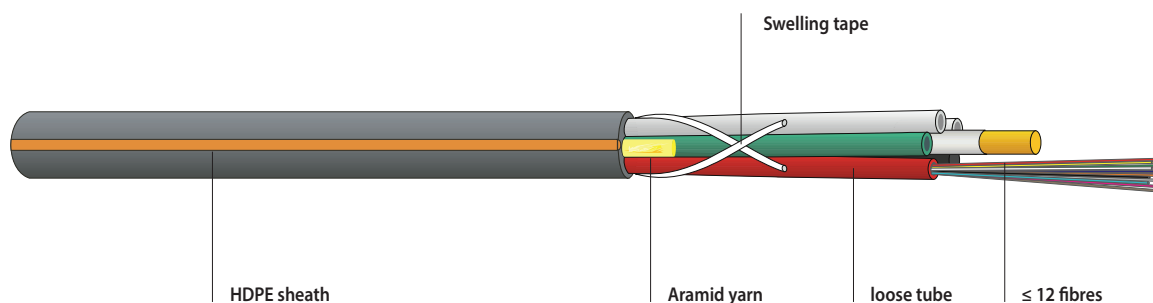

PRODUCT INFORMATION



FEATURES

Highly compact, metal-free fibre optic outdoor cable with up to 216 fibres in stranded loose tubes and with dry interstices. Easily cut-back, installation-friendly cable construction.

APPLICATION

FTTx, Fibre-to-the-home networks.
Optimised for injection into microducts.

OPTICAL CHARACTERISTICS

The following attenuation values are valid when using the fibre type G.652.D:

1310 nm:	1550 nm:	1625 nm:
≤ 0.36 dB/km	≤ 0.25 dB/km	≤ 0.30 dB/km

MECHANICAL CHARACTERISTICS

Temperature range	storage:	-25 / +70°C	IEC 60794-1-2 F1
	during installation/injection:	-2 / +35°C	
	in operation:	-25 / +70°C	
Tensile performance:	IEC 60794-1-2 E1		
Crush resistance:	IEC 60794-1-2 E3		
Repeated bending:	IEC 60794-1-2 E6		
Torsion:	IEC 60794-1-2 E7		
Bend:	IEC 60794-1-2 E11		
Water penetration:	IEC 60794-1-2 F5		

GENERAL CHARACTERISTICS

Printing example: DATWYLER «cable type» «Datwyler designation» «DIN designation»
«number of fibres» «fibre type» «additional text» «batch number»
~ ~ «meter marks» ~ ~

Zero halogen,
non corrosive gases IEC 60754-1/-2, EN 50267-2-1/2-2, VDE 0482-267-2-1/-2-2

INSTALLATION RECOMMENDATION

We recommend to use a special cable blowing machine that provides feed caterpillars made of rubber.

ACCESSORIES

Please find the appropriate FTTx accessories in the data sheets on our website or in the Datwyler FTTH catalogue.

Copper

Fibre Optics

Cabinets & Racks

Data Centre

Wireless

Multimedia

General Information

GF-MQ4FO Micro wbKT 96F-0714/e

PRODUCT INFORMATION

Description A-DQ(ZN)2Y n x m	No. of fibres	Loose tubes	Sheath Ø mm	Weight kg/km	Bending radius mm	Tensile load N	Crush resistance		Fire load	
							continuous N	short term N	kWh/km	MJ/km
wbKT S-Micro 2 x 12	24	2	4.2	13	250	750	400	1200	90	330
wbKT S-Micro 4 x 12	48	4	4.2	13	250	750	400	1200	90	330
wbKT S-Micro 8 x 12	96	8	6.6	37	250	1900	400	1200	180	640
wbKT S-Micro 9 x 24	216	9	8.4	60	300	1900	400	1200	325	1170

VERSIONS

Description A-DQ(ZN)2Y nxm	Fibres number	Article No. E9/125 G.652.D	Article No. E9/125 G.657.A1
wbKT S-Micro 2 x 12	24	–	192693
wbKT S-Micro 4 x 12	48	–	192150
wbKT S-Micro 8 x 12	96	193340	192149
wbKT S-Micro 9 x 24	216	192625	on request

FIBRE OPTIC TRUNKS

Pre-assembly of loose-tube cables

with all current FO connector types



Trunk termination

PRODUCT INFORMATION

DESCRIPTION

The pre-assembly of loose-tube cables from Datwyler enables customers to work with ready-to-install fibre optic multiple cables (trunks) in the requested lengths and types. The trunks are made to customer specifications under laboratory conditions. Pre-assembled trunks allow for cost saving and simple installations without expensive fibre optic equipment.

FEATURES

Trunk termination

- Termination of up to 144 fibres
- Termination with all current fibre optic connectors
- After the distribution splitter (screwable) each single fibre is protected by aramide yarn and has its own sheath
- Versions with more than 48 fibres come with 3-step (cascaded) fibre distribution
- Single fibre termination graded in length (maximum length after distribution splitter: 2 m)
- Delivery with crush-resistant hose protection (protection rating IP67), optional with braided sleeving only
- Delivery with optical attenuation measurement report (measurement with OTDR: optional at an extra charge)

Trunk termination (Article numbers are valid for FO connector termination on one side only)

Numer of fibres	Multimode connector types				Single-mode connector types					
	ST	SC	LC	LSH	ST	SC	LC	LSH	SC/APC	LSH/APC
4	1406098	1406421	416601	417131	417218	1407244	415096	417219	415001	417222
6	1407718	1407658	415018	417213	1407719	1407778	415014	415010	417221	415006
8	1406758	1407777	415028	417214	1405818	1410923	417132	417220	415002	417223
12	1406403	1406794	415019	417215	1407720	1407035	415015	415011	415003	415007
24	1406780	1408597	415020	417216	1408529	1406242	415016	415012	415004	415008
48	1406091	1408725	415021	417217	1408723	1406768	415017	415013	415005	415009

Attention: Please order the loose tube cable separately - according to your individual needs!

When ordering a trunk cable please ensure that the specified length of the trunk cable is defined by the length of the longest single optical fibre! This means: The total length of the trunk cable is the length of the cable between the two distribution splitters plus the additional length of the longest single optical fibre on both sides.

You can find the lengths of the single fibre elements in the installation manual on the Datwyler homepage.

Pre-assembly of breakout cables

with all current FO connector types



Breakout assembly

PRODUCT INFORMATION

DESCRIPTION

The pre-assembly of breakout cables from Datwyler enables customers to work with ready-to-install fibre optic multiple cables (trunks) in the requested lengths and types. The trunks are made to customer specifications under laboratory conditions. Pre-assembled trunks allow for cost saving and simple installations without expensive fibre optic equipment.

FEATURES

Breakout assembly

- Termination of up to 48 single-fibre cables
- Termination with all current fibre optic connectors
- Single fibre termination optionally graded in length
- Delivery with optical attenuation measurement report
- Delivery with braided sleeving (optional at an extra charge: with cable gland and/or crush-resistant hose protection)

Breakout assembly (Article numbers are valid for FO connector termination on one side only)

Breakout assembly on one cable end	Connector type	Number of connectors	Multimode fibre Article No.	Single-mode fibre Article No.
	SC	4	1410596	415023
	SC	8	1410597	415024
	SC	12	1410598	415025
	SC	24	415083	415081
	SC	48	415084	415082
	LC	4	415085	415090
	LC	8	415086	415091
	LC	12	415087	415092
	LC	24	415088	415093
	LC	48	415089	415094

Attention: Please order the breakout cable separately - according to your individual needs!
 When ordering a trunk cable please ensure that the specified length of the trunk cable is defined by the length of the longest single-fibre cable! This means: The total length of the trunk cable is the length of the cable between the two splits plus the additional length of the longest single-fibre cable on both sides.
 You can find the lengths of the single-fibre elements in the installation manual on the Datwyler homepage.

FIBRE OPTIC TRUNKS

FO flexible trunks

Dimensions & length determination of pre-assembled FO trunks

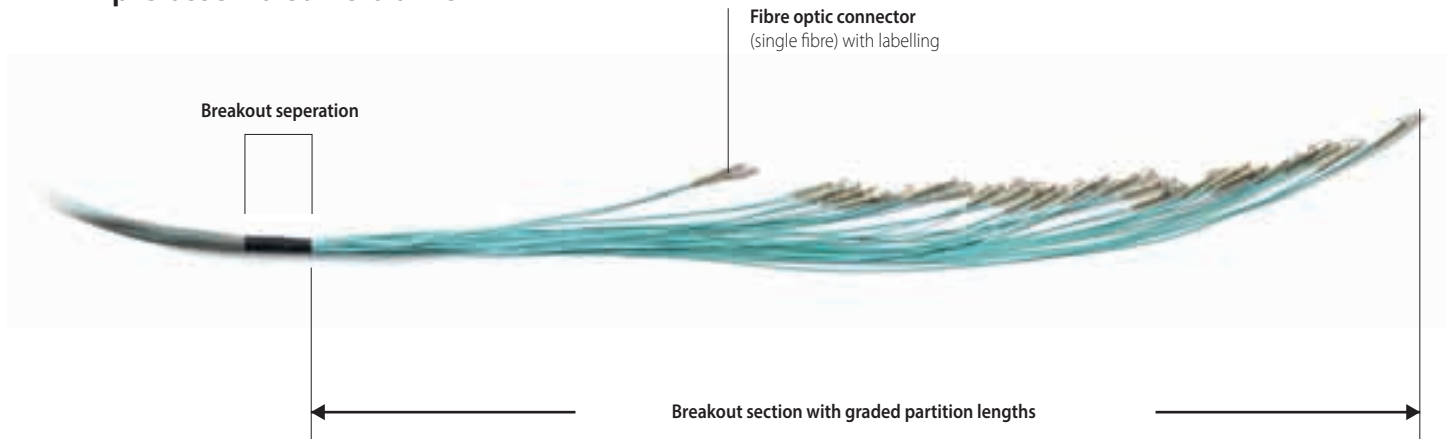

PRODUCT INFORMATION

DESCRIPTION

A Datwyler FO flexible trunk consists of up to 24 single fibre cables (per 2.0 mm) that are combined in a sturdy HDPE braided hose and have pre-assembled connectors on both ends. FO flexible trunks come in customized lengths and gradations. This solution is suitable especially for data centre cabling, rack-to-rack connections and multiple patch links. Delivery with optical attenuation measurement report. Please see page 258 for optical performance values.

LENGTH DETERMINATION

The following criteria are decisive for all pre-assembled FO trunks from Datwyler:

Length _{horizontal}	Horizontal distance between the racks (cable fed from ceiling/from below). We recommend the cables to be laid in trays above the racks to ensure that there will be no disruption to cooling air flow in the false floor. However, the cables can also be directed through the raised floor when it is amply dimensioned (not recommended for FO flexible trunks)
A1	Vertical distance up to the fixing point inside rack A
B1	Vertical distance up to the fixing point inside rack B
A2	Length of graded partition from fixing point to longest single fibre element
B2	Length of graded partition from fixing point to longest single fibre element

Pre-assembled loose-tube cables (page 242) always come with single fibres graded in length (for partition lengths see installation instructions on our website). This gradation may be customized, though.

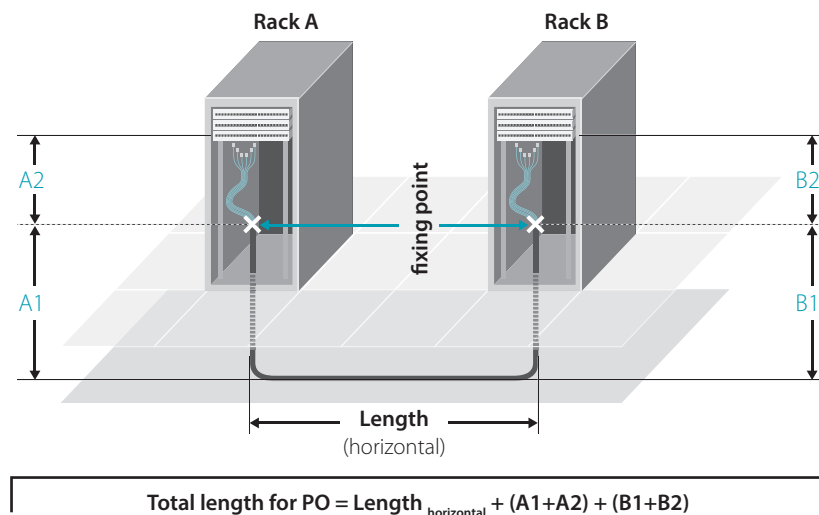

Checklist: Project planning with fibre optic trunks

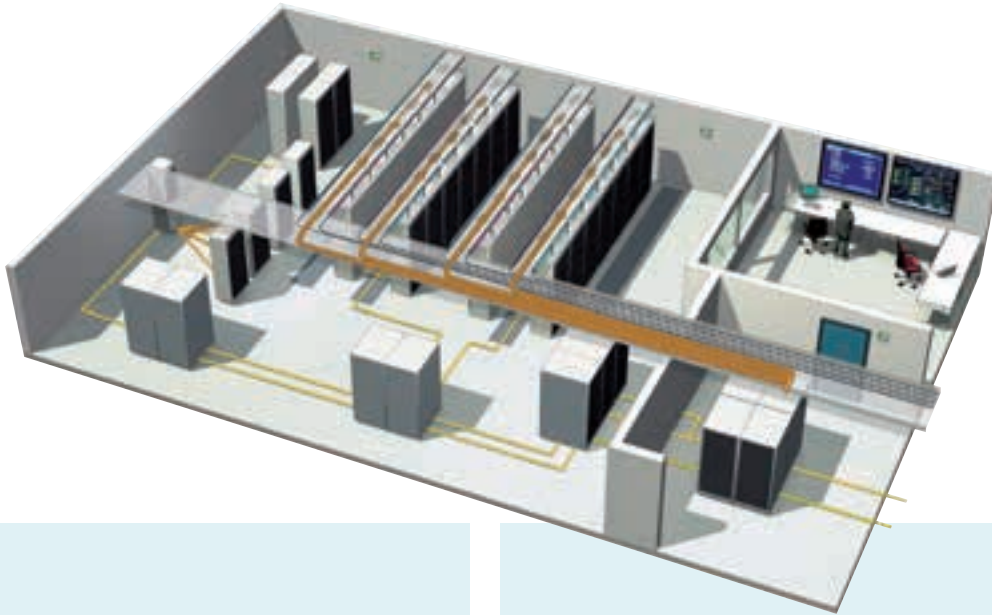

Project planning with fibre optic trunks

✓ DO YOU NEED THE FIBRE OPTIC TRUNKS FOR TODAY OR FUTURE NEEDS?

10GBase, 40GBase and 100GBase

✓ CHOOSE THE RIGHT FIBRE OPTIC CABLE TYPE OR SOLUTION!

Please select the cable type or solution on the basis of the needed performance class, lengths and number of fibres.

Breakout trunks and flexible trunks are particularly flexible in terms of fibre number. They do not need a distribution splitter and are suitable especially for comparatively short rack-to-rack connections with fibre numbers ≤ 24 .

✓ CHOOSE THE REQUESTED FIBRE TYPE!

OM4 is state-of-the-art in data centers (or OM3 at least). For single-mode it should be OS2.

✓ SELECT THE REQUESTED CONNECTOR TYPE!

LC is the most common connector for single fibres. It is also possible to choose any other connector type for trunk cable termination.

✓ WHAT WILL BE THE LENGTH OF THE FIBRE OPTIC TRUNKS?

Where do you want to install them?
In cable trays above the racks or in the false floor?
Please consider the diameter, the weight and the admissible bending radius of the trunks!

✓ HOW DO YOU WANT TO ROUTE THE CABLES INSIDE THE DISTRIBUTION RACK TO THE PATCH PANELS?

- side-fed from right?
- side-fed from left?
- centred from behind?
- or ...?

✓ THE SINGLE CABLES CAN BE GRADED IN LENGTH - DEPENDING ON HOW THE TRUNK CABLE IS FIXED INSIDE THE RACK.

The single cables may all have the same length, but this increases the dimensions of the connector protection. That's the reason why Datwyler offers single fibre termination graded in length. The single cable elements are usually placed in breakout boxes behind the management panels.

✓ CUSTOMER-SPECIFIC IMPRINT / LABELLING?

Available on request for all copper trunks.

✓ PLEASE CONSIDER SOME EXTRA TIME FOR THE PRE-ASSEMBLY IN YOUR TIMETABLE!

**YOU NEED CONSULTING SERVICE?
PLEASE DO NOT HESITATE TO CALL US.
WE WILL BE HAPPY TO HELP YOU!**

You will find the Datwyler phone numbers on the back page of this catalogue.
For all current information please see our website:
www.cabling.datwyler.com

Pigtails



PRODUCT INFORMATION

Pigtails

Connector type	Fibre type	Fibre pigtail 2 m	Set of 12 fibre pigtails 2 m*
SC/APC	E09/OS2	427721	427722
SC	E09/OS2	421121	421122
SC	G50/OM4	421144	421145
SC	G50/OM3	421141	421142
SC	G50/OM2	421161	421162
SC	G62.5/OM1	421181	421182
ST	E09/OS2	422221	422222
ST	G50/OM4	422244	422245
ST	G50/OM3	422241	422242
ST	G50/OM2	422261	422262
ST	G62.5/OM1	422281	422282
LC/APC	E09/OS2	429921	429922
LC	E09/OS2	423321	423322
LC	G50/OM4	423348	423349
LC	G50/OM3	423341	423342
LC	G50/OM2	423361	423362
LC	G62.5/OM1	423381	423382
LSH/APC	E9/OS2	428821	428822
LSH	E09/OS2	424421	424422
LSH	G50/OM3	424441	424442
LSH	G50/OM2	424461	424462
LSH	G62.5/OM1	424481	424482
FC/PC	E09/OS2	425521	425522
FC/PC	G50/OM3	425541	425542
FC/PC	G50/OM2	425561	425562
FC/PC	G62.5/OM1	425581	425582
MT-RJ	E09/OS2	426621	426622
MT-RJ	G50/OM3	426641	426642
MT-RJ	G50/OM2	426661	426662
MT-RJ	G62.5/OM1	426681	426682

* Set has 12 fibre pigtails in 12 colours (according to IEC 60304).

For parameters of all FO terminations see the data sheet "FO connector termination" / catalogue page 258.

FO-Pigtails 0612/e



FO patch cable SCD - ST



FO patch cable SCD - LCD



FO patch cable SCD - LSH

PRODUCT INFORMATION

Fibre optic patch cords SCD ...

Connector type		Fibre type	Length in m / Article No.									
Side A	Side B		1	2	3	4	5	6	7	8	9	10
SCD	SC/APC	E09/OS2	421711	421712	421713	421714	421715	421716	421717	421718	421719	421720
SCD	SCD	E09/OS2	421111	421112	421113	421114	421115	421116	421117	421118	421119	421120
SCD	SCD	G50/OM4	431141	431142	431143	431144	431145	431146	431147	431148	431149	431150
SCD	SCD	G50/OM3	421131	421132	421133	421134	421135	421136	421137	421138	421139	421140
SCD	SCD	G50/OM2	421151	421152	421153	421154	421155	421156	421157	421158	421159	421160
SCD	SCD	G62.5/OM1	421171	421172	421173	421174	421175	421176	421177	421178	421179	421180
SCD	ST	E09/OS2	421211	421212	421213	421214	421215	421216	421217	421218	421219	421220
SCD	ST	G50/OM3	421231	421232	421233	421234	421235	421236	421237	421238	421239	421240
SCD	ST	G50/OM2	421251	421252	421253	421254	421255	421256	421257	421258	421259	421260
SCD	ST	G62.5/OM1	421271	421272	421273	421274	421275	421276	421277	421278	421279	421280
SCD	LCD	E09/OS2	421311	421312	421313	421314	421315	421316	421317	421318	421319	421320
SCD	LCD	G50/OM4	431341	431342	431343	431344	431345	431346	431347	431348	431349	431350
SCD	LCD	G50/OM3	421331	421332	421333	421334	421335	421336	421337	421338	421339	421340
SCD	LCD	G50/OM2	421351	421352	421353	421354	421355	421356	421357	421358	421359	421360
SCD	LCD	G62.5/OM1	421371	421372	421373	421374	421375	421376	421377	421378	421379	421380
SCD	LSH/APC	E09/OS2	421811	421812	421813	421814	421815	421816	421817	421818	421819	421820
SCD	LSH	E09/OS2	421411	421412	421413	421414	421415	421416	421417	421418	421419	421420
SCD	LSH	G50/OM3	421431	421432	421433	421434	421435	421436	421437	421438	421439	421440
SCD	LSH	G50/OM2	421451	421452	421453	421454	421455	421456	421457	421458	421459	421460
SCD	LSH	G62.5/OM1	421471	421472	421473	421474	421475	421476	421477	421478	421479	421480
SCD	FC/PC	E09/OS2	421511	421512	421513	421514	421515	421516	421517	421518	421519	421520
SCD	FC/PC	G50/OM3	421531	421532	421533	421534	421535	421536	421537	421538	421539	421540
SCD	FC/PC	G50/OM2	421551	421552	421553	421554	421555	421556	421557	421558	421559	421560
SCD	FC/PC	G62.5/OM1	421571	421572	421573	421574	421575	421576	421577	421578	421579	421580
SCD	MT-RJ	E09/OS2	421611	421612	421613	421614	421615	421616	421617	421618	421619	421620
SCD	MT-RJ	G50/OM3	421631	421632	421633	421634	421635	421636	421637	421638	421639	421640
SCD	MT-RJ	G50/OM2	421651	421652	421653	421654	421655	421656	421657	421658	421659	421660
SCD	MT-RJ	G62.5/OM1	421671	421672	421673	421674	421675	421676	421677	421678	421679	421680

For parameters of all FO terminations see the data sheet "FO connector termination" / catalogue page 258.

Patch cords with Duplex connectors on both ends are delivered with a single Duplex clip which is not fixed to enable a change of polarity.

The polarity of these connectors is marked with cable clips "A" and "B" - please see the data sheet "FO connector termination" / catalogue page 258.

FO patch cable
ST ...



FO patch cable ST - SCD



FO patch cable ST - FC/PC



FO patch cable ST - MT-RJ

PRODUCT INFORMATION

Fibre optic patch cords ST ...

Connector type		Fibre type	Length in m / Article No.									
Side A	Side B		1	2	3	4	5	6	7	8	9	10
ST	SC/APC	E09/OS2	422711	422712	422713	422714	422715	422716	422717	422718	422719	422720
ST	SCD	E09/OS2	421211	421212	421213	421214	421215	421216	421217	421218	421219	421220
ST	SCD	G50/OM3	421231	421232	421233	421234	421235	421236	421237	421238	421239	421240
ST	SCD	G50/OM2	421251	421252	421253	421254	421255	421256	421257	421258	421259	421260
ST	SCD	G62.5/OM1	421271	421272	421273	421274	421275	421276	421277	421278	421279	421280
ST	ST	E09/OS2	422211	422212	422213	422214	422215	422216	422217	422218	422219	422220
ST	ST	G50/OM3	422231	422232	422233	422234	422235	422236	422237	422238	422239	422240
ST	ST	G50/OM2	422251	422252	422253	422254	422255	422256	422257	422258	422259	422260
ST	ST	G62.5/OM1	422271	422272	422273	422274	422275	422276	422277	422278	422279	422280
ST	LCD	E09/OS2	422311	422312	422313	422314	422315	422316	422317	422318	422319	422320
ST	LCD	G50/OM3	422331	422332	422333	422334	422335	422336	422337	422338	422339	422340
ST	LCD	G50/OM2	422351	422352	422353	422354	422355	422356	422357	422358	422359	422360
ST	LCD	G62.5/OM1	422371	422372	422373	422374	422375	422376	422377	422378	422379	422380
ST	LSH/APC	E09/OS2	422811	422812	422813	422814	422815	422816	422817	422818	422819	422820
ST	LSH	E09/OS2	422411	422412	422413	422414	422415	422416	422417	422418	422419	422420
ST	LSH	G50/OM3	422431	422432	422433	422434	422435	422436	422437	422438	422439	422440
ST	LSH	G50/OM2	422451	422452	422453	422454	422455	422456	422457	422458	422459	422460
ST	LSH	G62.5/OM1	422471	422472	422473	422474	422475	422476	422477	422478	422479	422480
ST	FC/PC	E09/OS2	422511	422512	422513	422514	422515	422516	422517	422518	422519	422520
ST	FC/PC	G50/OM3	422531	422532	422533	422534	422535	422536	422537	422538	422539	422540
ST	FC/PC	G50/OM2	422551	422552	422553	422554	422555	422556	422557	422558	422559	422560
ST	FC/PC	G62.5/OM1	422571	422572	422573	422574	422575	422576	422577	422578	422579	422580
ST	MT-RJ	E09/OS2	422611	422612	422613	422614	422615	422616	422617	422618	422619	422620
ST	MT-RJ	G50/OM3	422631	422632	422633	422634	422635	422636	422637	422638	422639	422640
ST	MT-RJ	G50/OM2	422651	422652	422653	422654	422655	422656	422657	422658	422659	422660
ST	MT-RJ	G62.5/OM1	422671	422672	422673	422674	422675	422676	422677	422678	422679	422680

For parameters of all FO terminations see the data sheet "FO connector termination" / catalogue page 258.

Patch cords with Duplex connectors on both ends are delivered with a single Duplex clip which is not fixed to enable a change of polarity.

The polarity of these connectors is marked with cable clips "A" and "B" - please see the data sheet "FO connector termination" / catalogue page 258.

FO Patchkabel ST 0612/e



FO patch cable LCD - LCD

FO patch cable LCD - LSH/APC

FO patch cable LCD - SC/APC

PRODUCT INFORMATION

Fibre optic patch cords LCD ...

Connector type		Fibre type	Length in m / Article No.									
Side A	Side B		1	2	3	4	5	6	7	8	9	10
LCD	SC/APC	E09/OS2	423711	423712	423713	423714	423715	423716	423717	423718	423719	423720
LCD	SCD	E09/OS2	421311	421312	421313	421314	421315	421316	421317	421318	421319	421320
LCD	SCD	G50/OM4	431341	431342	431343	431344	431345	431346	431347	431348	431349	431350
LCD	SCD	G50/OM3	421331	421332	421333	421334	421335	421336	421337	421338	421339	421340
LCD	SCD	G50/OM2	421351	421352	421353	421354	421355	421356	421357	421358	421359	421360
LCD	SCD	G62.5/OM1	421371	421372	421373	421374	421375	421376	421377	421378	421379	421380
LCD	ST	E09/OS2	422311	422312	422313	422314	422315	422316	422317	422318	422319	422320
LCD	ST	G50/OM3	422331	422332	422333	422334	422335	422336	422337	422338	422339	422340
LCD	ST	G50/OM2	422351	422352	422353	422354	422355	422356	422357	422358	422359	422360
LCD	ST	G62.5/OM1	422371	422372	422373	422374	422375	422376	422377	422378	422379	422380
LCD	LCD	E09/OS2	423311	423312	423313	423314	423315	423316	423317	423318	423319	423320
LCD	LCD	G50/OM3	423331	423332	423333	423334	423335	423336	423337	423338	423339	423340
LCD	LCD	G50/OM2	423351	423352	423353	423354	423355	423356	423357	423358	423359	423360
LCD	LCD	G62.5/OM1	423371	423372	423373	423374	423375	423376	423377	423378	423379	423380
LCD	LSH/APC	E09/OS2	423811	423812	423813	423814	423815	423816	423817	423818	423819	423820
LCD	LSH	E09/OS2	423411	423412	423413	423414	423415	423416	423417	423418	423419	423420
LCD	LSH	G50/OM3	423431	423432	423433	423434	423435	423436	423437	423438	423439	423440
LCD	LSH	G50/OM2	423451	423452	423453	423454	423455	423456	423457	423458	423459	423460
LCD	LSH	G62.5/OM1	423471	423472	423473	423474	423475	423476	423477	423478	423479	423480
LCD	FC/PC	E09/OS2	423511	423512	423513	423514	423515	423516	423517	423518	423519	423520
LCD	FC/PC	G50/OM3	423531	423532	423533	423534	423535	423536	423537	423538	423539	423540
LCD	FC/PC	G50/OM2	423551	423552	423553	423554	423555	423556	423557	423558	423559	423560
LCD	FC/PC	G62.5/OM1	423571	423572	423573	423574	423575	423576	423577	423578	423579	423580
LCD	MT-RJ	E09/OS2	423611	423612	423613	423614	423615	423616	423617	423618	423619	423620
LCD	MT-RJ	G50/OM3	423631	423632	423633	423634	423635	423636	423637	423638	423639	423640
LCD	MT-RJ	G50/OM2	423651	423652	423653	423654	423655	423656	423657	423658	423659	423660
LCD	MT-RJ	G62.5/OM1	423671	423672	423673	423674	423675	423676	423677	423678	423679	423680

For parameters of all FO terminations see the data sheet "FO connector termination" / catalogue page 258.

Patch cords with Duplex connectors on both ends are delivered with a single Duplex clip which is not fixed to enable a change of polarity.

The polarity of these connectors is marked with cable clips "A" and "B" - please see the data sheet "FO connector termination" / catalogue page 258.

FO patch cable
LSH ...



FO patch cable LSH - SCD



FO patch cable LSH - SCD



FO patch cable LSH - SC/APC

PRODUCT INFORMATION

Fibre optic patch cords LSH ...

Connector type		Fibre type	Length in m / Article No.									
Side A	Side B		1	2	3	4	5	6	7	8	9	10
LSH	SC/APC	E09/OS2	414711	414712	414713	414714	414715	414716	414717	414718	414719	414720
LSH	SCD	E09/OS2	421411	421412	421413	421414	421415	421416	421417	421418	421419	421420
LSH	SCD	G50/OM3	421431	421432	421433	421434	421435	421436	421437	421438	421439	421440
LSH	SCD	G50/OM2	421451	421452	421453	421454	421455	421456	421457	421458	421459	421460
LSH	SCD	G62.5/OM1	421471	421472	421473	421474	421475	421476	421477	421478	421479	421480
LSH	ST	E09/OS2	422411	422412	422413	422414	422415	422416	422417	422418	422419	422420
LSH	ST	G50/OM3	422431	422432	422433	422434	422435	422436	422437	422438	422439	422440
LSH	ST	G50/OM2	422451	422452	422453	422454	422455	422456	422457	422458	422459	422460
LSH	ST	G62.5/OM1	422471	422472	422473	422474	422475	422476	422477	422478	422479	422480
LSH	LCD	E09/OS2	423411	423412	423413	423414	423415	423416	423417	423418	423419	423420
LSH	LCD	G50/OM3	423431	423432	423433	423434	423435	423436	423437	423438	423439	423440
LSH	LCD	G50/OM2	423451	423452	423453	423454	423455	423456	423457	423458	423459	423460
LSH	LCD	G62.5/OM1	423471	423472	423473	423474	423475	423476	423477	423478	423479	423480
LSH	LSH/APC	E09/OS2	424811	424812	424813	424814	424815	424816	424817	424818	424819	424820
LSH	LSH	E09/OS2	424411	424412	424413	424414	424415	424416	424417	424418	424419	424420
LSH	LSH	G50/OM3	424431	424432	424433	424434	424435	424436	424437	424438	424439	424440
LSH	LSH	G50/OM2	424451	424452	424453	424454	424455	424456	424457	424458	424459	424460
LSH	LSH	G62.5/OM1	424471	424472	424473	424474	424475	424476	424477	424478	424479	424480
LSH	FC/PC	E09/OS2	424511	424512	424513	424514	424515	424516	424517	424518	424519	424520
LSH	FC/PC	G50/OM3	424531	424532	424533	424534	424535	424536	424537	424538	424539	424540
LSH	FC/PC	G50/OM2	424551	424552	424553	424554	424555	424556	424557	424558	424559	424560
LSH	FC/PC	G62.5/OM1	424571	424572	424573	424574	424575	424576	424577	424578	424579	424580
LSH	MT-RJ	E09/OS2	424611	424612	424613	424614	424615	424616	424617	424618	424619	424620
LSH	MT-RJ	G50/OM3	424631	424632	424633	424634	424635	424636	424637	424638	424639	424640
LSH	MT-RJ	G50/OM2	424651	424652	424653	424654	424655	424656	424657	424658	424659	424660
LSH	MT-RJ	G62.5/OM1	424671	424672	424673	424674	424675	424676	424677	424678	424679	424680

For parameters of all FO terminations see the data sheet "FO connector termination" / catalogue page 258.

Patch cords with Duplex connectors on both ends are delivered with a single Duplex clip which is not fixed to enable a change of polarity.

The polarity of these connectors is marked with cable clips "A" and "B" - please see the data sheet "FO connector termination" / catalogue page 258.

FO Patchkabel LSH 0612/e



FO patch cable FC/PC - FC/PC



FO patch cable FC/PC - LSH/APC



FO patch cable FC/PC - SC/APC

PRODUCT INFORMATION

Fibre optic patch cords FC/PC ...

Connector type		Fibre type	Length in m / Article No.									
Side A	Side B		1	2	3	4	5	6	7	8	9	10
FC/PC	SC/APC	E09/OS2	425711	425712	425713	425714	425715	425716	425717	425718	425719	425720
FC/PC	SCD	E09/OS2	421511	421512	421513	421514	421515	421516	421517	421518	421519	421520
FC/PC	SCD	G50/OM3	421531	421532	421533	421534	421535	421536	421537	421538	421539	421540
FC/PC	SCD	G50/OM2	421551	421552	421553	421554	421555	421556	421557	421558	421559	421560
FC/PC	SCD	G62.5/OM1	421571	421572	421573	421574	421575	421576	421577	421578	421579	421580
FC/PC	ST	E09/OS2	422511	422512	422513	422514	422515	422516	422517	422518	422519	422520
FC/PC	ST	G50/OM3	422531	422532	422533	422534	422535	422536	422537	422538	422539	422540
FC/PC	ST	G50/OM2	422551	422552	422553	422554	422555	422556	422557	422558	422559	422560
FC/PC	ST	G62.5/OM1	422571	422572	422573	422574	422575	422576	422577	422578	422579	422580
FC/PC	LCD	E09/OS2	423511	423512	423513	423514	423515	423516	423517	423518	423519	423520
FC/PC	LCD	G50/OM3	423531	423532	423533	423534	423535	423536	423537	423538	423539	423540
FC/PC	LCD	G50/OM2	423551	423552	423553	423554	423555	423556	423557	423558	423559	423560
FC/PC	LCD	G62.5/OM1	423571	423572	423573	423574	423575	423576	423577	423578	423579	423580
FC/PC	LSH/APC	E09/OS2	425811	425812	425813	425814	425815	425816	425817	425818	425819	425820
FC/PC	LSH	E09/OS2	424511	424512	424513	424514	424515	424516	424517	424518	424519	424520
FC/PC	LSH	G50/OM3	424531	424532	424533	424534	424535	424536	424537	424538	424539	424540
FC/PC	LSH	G50/OM2	424551	424552	424553	424554	424555	424556	424557	424558	424559	424560
FC/PC	LSH	G62.5/OM1	424571	424572	424573	424574	424575	424576	424577	424578	424579	424580
FC/PC	FC/PC	E09/OS2	425511	425512	425513	425514	425515	425516	425517	425518	425519	425520
FC/PC	FC/PC	G50/OM3	425531	425532	425533	425534	425535	425536	425537	425538	425539	425540
FC/PC	FC/PC	G50/OM2	425551	425552	425553	425554	425555	425556	425557	425558	425559	425560
FC/PC	FC/PC	G62.5/OM1	425571	425572	425573	425574	425575	425576	425577	425578	425579	425580
FC/PC	MT-RJ	E09/OS2	425611	425612	425613	425614	425615	425616	425617	425618	425619	425620
FC/PC	MT-RJ	G50/OM3	425631	425632	425633	425634	425635	425636	425637	425638	425639	425640
FC/PC	MT-RJ	G50/OM2	425651	425652	425653	425654	425655	425656	425657	425658	425659	425660
FC/PC	MT-RJ	G62.5/OM1	425671	425672	425673	425674	425675	425676	425677	425678	425679	425680

For parameters of all FO terminations see the data sheet "FO connector termination" / catalogue page 258.

Patch cords with Duplex connectors on both ends are delivered with a single Duplex clip which is not fixed to enable a change of polarity.

The polarity of these connectors is marked with cable clips "A" and "B" - please see the data sheet "FO connector termination" / catalogue page 258.

FIBRE OPTIC PATCH CORDS

**FO patch cable
MT-RJ ...**



FO patch cable MT-RJ - ST



FO patch cable MT-RJ - LCD



FO patch cable MT-RJ - MT-RJ

PRODUCT INFORMATION

Fibre optic patch cords MT-RJ ...

Connector type		Fibre type	Length in m / Article No.									
Side A	Side B		1	2	3	4	5	6	7	8	9	10
MT-RJ	SCD	E09/OS2	421611	421612	421613	421614	421615	421616	421617	421618	421619	421620
MT-RJ	SCD	G50/OM3	421631	421632	421633	421634	421635	421636	421637	421638	421639	421640
MT-RJ	SCD	G50/OM2	421651	421652	421653	421654	421655	421656	421657	421658	421659	421660
MT-RJ	SCD	G62.5/OM1	421671	421672	421673	421674	421675	421676	421677	421678	421679	421680
MT-RJ	ST	E09/OS2	422611	422612	422613	422614	422615	422616	422617	422618	422619	422620
MT-RJ	ST	G50/OM3	422631	422632	422633	422634	422635	422636	422637	422638	422639	422640
MT-RJ	ST	G50/OM2	422651	422652	422653	422654	422655	422656	422657	422658	422659	422660
MT-RJ	ST	G62.5/OM1	422671	422672	422673	422674	422675	422676	422677	422678	422679	422680
MT-RJ	LCD	E09/OS2	423611	423612	423613	423614	423615	423616	423617	423618	423619	423620
MT-RJ	LCD	G50/OM3	423631	423632	423633	423634	423635	423636	423637	423638	423639	423640
MT-RJ	LCD	G50/OM2	423651	423652	423653	423654	423655	423656	423657	423658	423659	423660
MT-RJ	LCD	G62.5/OM1	423671	423672	423673	423674	423675	423676	423677	423678	423679	423680
MT-RJ	LSH	E09/OS2	424611	424612	424613	424614	424615	424616	424617	424618	424619	424620
MT-RJ	LSH	G50/OM3	424631	424632	424633	424634	424635	424636	424637	424638	424639	424640
MT-RJ	LSH	G50/OM2	424651	424652	424653	424654	424655	424656	424657	424658	424659	424660
MT-RJ	LSH	G62.5/OM1	424671	424672	424673	424674	424675	424676	424677	424678	424679	424680
MT-RJ	FC/PC	E09/OS2	425611	425612	425613	425614	425615	425616	425617	425618	425619	425620
MT-RJ	FC/PC	G50/OM3	425631	425632	425633	425634	425635	425636	425637	425638	425639	425640
MT-RJ	FC/PC	G50/OM2	425651	425652	425653	425654	425655	425656	425657	425658	425659	425660
MT-RJ	FC/PC	G62.5/OM1	425671	425672	425673	425674	425675	425676	425677	425678	425679	425680
MT-RJ	MT-RJ	E09/OS2	426611	426612	426613	426614	426615	426616	426617	426618	426619	426620
MT-RJ	MT-RJ	G50/OM3	426631	426632	426633	426634	426635	426636	426637	426638	426639	426640
MT-RJ	MT-RJ	G50/OM2	426651	426652	426653	426654	426655	426656	426657	426658	426659	426660
MT-RJ	MT-RJ	G62.5/OM1	426671	426672	426673	426674	426675	426676	426677	426678	426679	426680

For parameters of all FO terminations see the data sheet "FO connector termination" / catalogue page 258.
Patch cords with Duplex connectors on both ends are delivered with a single Duplex clip which is not fixed.
In Patch cords with MT-RJ connectors on both sides the fibres are crossed.

The polarity of these connectors is marked with cable clips "A" and "B" - please see the data sheet "FO connector termination" / catalogue page 258.



FO patch cable FC/PC - SC/APC



FO patch cable SC/APC - LC



FO patch cable SC/APC - SC/APC

PRODUCT INFORMATION

Fibre optic patch cords SC/APC ...

Connector type		Fibre type	Length in m / Article No.									
Side A	Side B		1	2	3	4	5	6	7	8	9	10
SC/APC	SCD	E09/OS2	421711	421712	421713	421714	421715	421716	421717	421718	421719	421720
SC/APC	ST	E09/OS2	422711	422712	422713	422714	422715	422716	422717	422718	422719	422720
SC/APC	LCD	E09/OS2	423711	423712	423713	423714	423715	423716	423717	423718	423719	423720
SC/APC	LSH	E09/OS2	414711	414712	414713	414714	414715	414716	414717	414718	414719	414720
SC/APC	FC/PC	E09/OS2	425711	425712	425713	425714	425715	425716	425717	425718	425719	425720
SC/APC	SC/APC	E09/OS2	427711	427712	427713	427714	427715	427716	427717	427718	427719	427720
SC/APC	LSH/APC	E09/OS2	427811	427812	427813	427814	427815	427816	427817	427818	427819	427820

For parameters of all FO terminations see the data sheet "FO connector termination" / catalogue page 258.

Patch cords with Duplex connectors on both ends are delivered with a single Duplex clip which is not fixed to enable a change of polarity.

The polarity of these connectors is marked with cable clips "A" and "B" - please see the data sheet "FO connector termination" / catalogue page 258.

FIBRE OPTIC PATCH CORDS

FO patch cable
LSH/APC ...



FO patch cable LSH/APC - FC/PC



FO patch cable LSH/APC - LCD



FO patch cable LSH/APC - SC/APC

PRODUCT INFORMATION

Fibre optic patch cords LSH/APC ...

Connector type		Fibre type	Length in m / Article No.									
Side A	Side B		1	2	3	4	5	6	7	8	9	10
LSH/APC	SCD	E09/OS2	421811	421812	421813	421814	421815	421816	421817	421818	421819	421820
LSH/APC	ST	E09/OS2	422811	422812	422813	422814	422815	422816	422817	422818	422819	422820
LSH/APC	LCD	E09/OS2	423811	423812	423813	423814	423815	423816	423817	423818	423819	423820
LSH/APC	LSH	E09/OS2	424811	424812	424813	424814	424815	424816	424817	424818	424819	424820
LSH/APC	FC/PC	E09/OS2	425811	425812	425813	425814	425815	425816	425817	425818	425819	425820
LSH/APC	SC/APC	E09/OS2	427811	427812	427813	427814	427815	427816	427817	427818	427819	427820
LSH/APC	LSH/APC	E09/OS2	428811	428812	428813	428814	428815	428816	428817	428818	428819	428820

For parameters of all FO terminations see the data sheet "FO connector termination" / catalogue page 258.

Patch cords with Duplex connectors on both ends are delivered with a single Duplex clip which is not fixed to enable a change of polarity.

The polarity of these connectors is marked with cable clips "A" and "B" - please see the data sheet "FO connector termination" / catalogue page 258.

Copper

Fibre Optics

Cabinets & Racks

Data Centre

Wireless

Multimedia

General Information

FO Patchkabel LSH/APC 0612/e



FO patch cable LCD/APC - LSH/APC



FO patch cable LCD/APC - LSH



FO patch cable LCD/APC - SC/APC

PRODUCT INFORMATION

Fibre optic patch cords LCD/APC ...

Connector type		Fibre type	Length in m / Article No.									
Side A	Side B		1	2	3	4	5	6	7	8	9	10
LCD/APC	SCD	E09	421911	421912	421913	421914	421915	421916	421917	421918	421919	421920
LCD/APC	LCD	E09	423911	423912	423913	423914	423915	423916	423917	423918	423919	423920
LCD/APC	LSH	E09	424911	424912	424913	424914	424915	424916	424917	424918	424919	424920
LCD/APC	SCD/APC	E09	427911	427912	427913	427914	427915	427916	427917	427918	427919	427920
LCD/APC	LSH/APC	E09	428911	428912	428913	428914	428915	428916	428917	428918	428919	428920
LCD/APC	LCD/APC	E09	429911	429912	429913	429914	429915	429916	429917	429918	429919	429920

For parameters of all FO terminations see the data sheet "FO connector termination" / catalogue page 258.

Patch cords with Duplex connectors on both ends are delivered with a single Duplex clip which is not fixed to enable a change of polarity.

The polarity of these connectors is marked with cable clips "A" and "B" - please see the data sheet "FO connector termination" / catalogue page 258.

FIBRE OPTIC CONNECTORS

FO adapters
FO couplers



PRODUCT INFORMATION

FO adapter	Fibre type	Sleeve	Cover material	Colour	Mounting	2 pieces M2 screws	PU	Article No.
ST	MM/SM	ceramic	metal		D hole		1 pc.	1414886
SC/APC	SM	ceramic	polymer	green	flange	without	1 pc.	418506
SCD	MM	PB	polymer	beige	flange	without	1 pc.	418507
SCD	MM	ceramic	polymer	beige	flange	without	1 pc.	418508
SCD	MM	PB	polymer	turquoise	flange	without	1 pc.	418509
SCD	MM	ceramic	polymer	turquoise	flange	without	1 pc.	418510
SCD	MM	PB	polymer	violet	flange	without	1 pc.	418534
SCD	MM	ceramic	polymer	violet	flange	without	1 pc.	418532
SCD	SM	ceramic	polymer	blue	flange	without	1 pc.	418511
SCD/APC	SM	ceramic	polymer	green	flange	without	1 pc.	418512
LCD	MM	ceramic	polymer	beige	flange	without	1 pc.	418513
LCD	MM	ceramic	polymer	turquoise	flange	without	1 pc.	418516
LCD	MM	ceramic	polymer	violet	flange	without	1 pc.	418531
LCD	SM	ceramic	polymer	blue	flange	without	1 pc.	418514
LCD/APC	SM	ceramic	polymer	green	flange	without	1 pc.	418515
LCD	MM	ceramic	polymer	beige	without flange	without	1 pc.	418525 ¹⁾
LCD	SM	ceramic	polymer	blue	without flange	without	1 pc.	418526 ¹⁾
LCD/APC	SM	ceramic	polymer	green	without flange	without	1 pc.	418527 ¹⁾
LCD	MM	ceramic	polymer	turquoise	without flange	without	1 pc.	418528 ¹⁾
LCD	MM	ceramic	polymer	violet	without flange	without	1 pc.	418533 ¹⁾
LCQ	MM	ceramic	polymer	beige	flange	without	1 pc.	418517
LCQ	MM	ceramic	polymer	turquoise	flange	without	1 pc.	418518
LCQ	MM	ceramic	polymer	violet	flange	without	1 pc.	418530
LCQ	SM	ceramic	polymer	blue	flange	without	1 pc.	418519
LCQ/APC	SM	ceramic	polymer	green	flange	without	1 pc.	418520
SCD	MM	PB	metal		flange	yes	1 pc.	418521
SCD	MM	ceramic	metal		flange	yes	1 pc.	418522
SCD	SM	ceramic	metal		flange	yes	1 pc.	418523
SCD/APC	SM	ceramic	metal		flange	yes	1 pc.	418524
FC/PC	MM/SM	ceramic	metal		D hole		1 pc.	1412762
LSH/APC-M adapter, without frame, with laser protection	SM	ceramic	polymer	green	flange with thread	yes	12 pcs.	418542 ²⁾
Frame for LSH adapter			polymer	green			12 pcs.	418541
Frame for LSH adapter			polymer	black			12 pcs.	417854
LSH-M adapter, without frame, with laser protection	SM	ceramic	polymer	blue	flange with thread	yes	12 pcs.	418543 ²⁾
Frame for LSH adapter			polymer	blue			12 pcs.	418544
LSH-M adapter, without frame, with laser protection	MM	ceramic	polymer	beige	flange with thread	yes	12 pcs.	418536 ²⁾
Frame for LSH adapter			polymer	orange			12 pcs.	418537
Frame for LSH adapter			polymer	turquoise			12 pcs.	418538
Frame for LSH adapter			polymer	violet			12 pcs.	418539
Frame for LSH adapter			polymer	beige			12 pcs.	418540

¹⁾ These adapters are used with Datwyler FO-DCS subracks 7HP/3U - Article No. 417212.

²⁾ Please order two additional frames for each adapter.

FO-Adapter/Kupplungen 0214/e



Shutter for SC Duplex



Shutter for LC Duplex and SC Simplex



Blind covers: ST/FC



SC/LSH/LCD

SCD/LCQ

PRODUCT INFORMATION

Description	Fibre type	Cover material	Colour	Article No.
Shutter for SCD POL BG	MM	polymer	beige	1414889
Shutter for SCD POL BL	SM	polymer	blue	1414887
Shutter for SCD POL GN	SM	polymer	green	1414888
Shutter for LCD	MM	polymer	beige	414492
Shutter for LCD and SC simplex	MM	polymer	turquoise	414493
Shutter for LCD	SM	polymer	blue	414494
Shutter for LCD	SM	polymer	green	414495
Blind cover SC/LSH/LCD (21.5 mm)				1 piece 418596
Blind cover SCD /LCQ				1 piece 1414224
Blind cover ST/FC				1 piece 1414225
Self-tapping screw M 2.5 x 6 mm				50 pieces 418535
Screws and nuts M2				50 pieces 418599

FO connector termination

Optical performance values



LSH/APC-M

ST

LC

MTP®/MPO

SC

PRODUCT INFORMATION

FEATURES

Datwyler offers a broad range of terminated connectors for individual customer needs, such as the connector types SC, LC, ST, LSH, FC/PC, MU, MT-RJ, MTP/MPO, and others. These can be supplied in simplex as well as in duplex variants. Most types are available as APC/HRL variants, too. We are also able to deliver terminations for higher optical performance requirements.

Ferrule material:	Zirconia; MT-RJ and MPO: Polymer
Lifetime:	1000 connections with stable attenuation values
Test conditions IL:	IEC 61300-3-4
Test conditions RL:	IEC 61300-3-6
Reproducibility of the IL value:	during the whole lifetime a maximum of +/- 0.1 dB
Operating temperature:	-10° C up to +60° C

Connector	IL [dB] typical	IL [dB] maximum	RL [dB] typical	RL [dB] minimum	Grade (IEC 61755)
MM	0.15	0.3	35	30	better than Bm2m
SM	0.15	0.3	55	50	better than B2
SM/APC	0.15	0.3	70	65	better than B1
MT-RJ	0.5	0.75	25	20	better than Cm2m
MTP®/MPO MM	0.1	0.35	25	20	better than Bm2m
MTP®/MPO SM	0.1	0.35	65	60	better than C1

All connectors are tested with our simplex, duplex and Mini Zipcord cables as well as our pigtails.

NOTE

Our single fibre cables and the connectors of our Duplex patch cables are marked with cable clips „A“ and „B“.



There is a single Duplex clip enclosed to enable a change of polarity.

Wiring of an FO Duplex patch cable A to B



MTP® is a registered brand of US Conec.



Fig. 1: FO faceplate 2x SCD with intermediate frame (70 x 70 mm)



Fig. 2: FO faceplate 2x SCD



Fig. 3: Surface mount box for Datwyler FO faceplates



Fig. 4: Distance frame for surface mount box

PRODUCT INFORMATION

APPLICATION

Faceplates and outlets especially for the high-speed transmission of voice, video and data in accordance with the EN 50173.

DESCRIPTION

Flush and surface/duct mount FO faceplates for SCD adapters

Cut-outs: for 2x SCD adapter
 Outlet attachment: 90 or 180 degree

Article No.	Description	Colour (similar to)	Fig.
1406935	FO outlet for 2x SCD (without cover frame and adapters)	RAL 1013, oyster white	1
1406936	FO outlet for 2x SCD (without cover frame and adapters)	RAL 9010, pure white	1
1407120	FO outlet for 1x SCD (without cover frame and adapters)	RAL 9010, pure white	
1400830	Cover frame 80 x 80 mm	RAL 9010, pure white	
1401630	Cover frame 80 x 80 mm	RAL 1013, oyster white	

Article No.	Description	Colour (similar to)	Fig.
1407837	FO outlet (without insert and cover frame)	RAL 9010, pure white	2
1407611	Insert for 2x SCD for FO outlet No. 1407837 (without adapters)		2
1404390	Cover frame for FO outlet No. 1407837		

ACCESSORIES

Surface mount box for Datwyler FO outlets

W x H x D: 80 x 80 x 40 mm.
 With the distance frame the assembly height can be adjusted from 40 mm to 50 mm.

Article No.	Description	Colour (similar to)	PU	Fig.
1406274	Surface mount box 40 mm with cover frame	RAL 1013, oyster white	1 pc.	3
1406276	Distance frame 10 mm for surface mount box	RAL 1013, oyster white	1 pc.	4
1406273	Surface mount box 40 mm with cover frame	RAL 9010, pure white	1 pc.	3
1406275	Distance frame 10 mm for surface mount box	RAL 9010, pure white	1 pc.	4

FO patch panel OV-AT

19"/1U, unloaded

exchangeable front plate, telescopic slides,
depth-adjustable mounting



Fibre optic patch panel OV-AT, 19"/1U, without front plate,
with telescopic slides, depth-adjustable mounting

PRODUCT INFORMATION

APPLICATION For the termination of fibre optic cables (breakout, loose tube) - maximum of 96 fibres.
Applicable with a wide range of front plates / connector systems (see OV-AT / OV-S 1U accessories).

DESCRIPTION

Housing:	metallic, with telescopic slides and locking mechanism
Rack mounting:	depth-adjustable mounting of box (5 steps, maximum 50 mm) due to the adjustable 19" mounting brackets
Colour of mounting brackets (variants):	similar to RAL 7035, similar to RAL 9005 or stainless steel numbers (silk screen printing) on front plate (to be ordered separately)
Imprint:	up to 96 fibres
Capacity:	with cable tie and screwed cable gland or cable distributor
Strain relief:	rear left and right (the openings are covered with a blind cover and a straight cable entry plate with M20 and M25 slotted holes - Article No. 416994)
Cable entry:	19"/1U, depth 254 mm
Dimensions:	

CONNECTOR SYSTEM Adapter: ST, FC, SCD, SC, LSH, LCD (dependent on front plate)

SCOPE OF DELIVERY Box, strain relief with M20 (1U) cable gland, splice tray holder and adhesive fibre fixation (3 pcs.)

Please order the front plate separately.

Article No.	Description	Colour (similar to)	Note
416964	OV-AT telescopic 1U	RAL 7035	without front plate
(on request)	OV-AT telescopic 1U	RAL 9005	without front plate
416975	OV-AT telescopic 1U	stainless steel	without front plate
1405304	Label for OV-AT, self-adhesive, length 420 mm		

FO patch panel OV-S

19"/1U, unloaded

exchangeable front plate, extractable,
depth-adjustable mounting



Fibre optic patch panel OV-S, 19"/1U, without front plate, extractable, depth-adjustable mounting

PRODUCT INFORMATION

APPLICATION For the termination of fibre optic cables (breakout, loose tube) - maximum of 96 fibres. Applicable with a wide range of front plates / connector systems (see OV-S / OV-AT 1U accessories).

DESCRIPTION

Housing: metallic, extractable drawer with locking mechanism
 Rack mounting: depth-adjustable mounting of box (5 steps, maximum 50 mm) due to the adjustable 19" mounting brackets

Colour mounting brackets (variants): similar to RAL 7035, similar to RAL 9005 and stainless steel
 Capacity: up to 96 fibres
 Strain relief: with cable tie and screwed cable gland or cable distributor
 Cable entry: rear left and right (two big openings, covered with straight cable entry plates: Article No. 415308 with pre-stamped cable entries M20 and M25 and Article No. 418650 with pre-stamped cable entries 2x M15, 1x M20 – these pre-stamped holes can be opened as necessary)

Dimensions: 19"/1U, depth 300 mm

OPTION An additional element (folding mechanism) allows the drawer to be hinged down at a 45 degree angle (tool-less assembly)

CONNECTOR SYSTEM Adapter: ST, FC, SCD, SC, LSH, LCD (dependent on front plate)

SCOPE OF DELIVERY Box, with straight cable entry plates, splice tray holder.

Please order the front plate separately.

Article No.	Description	Mounting brackets Colour (similar to)	Note
415201	OV-S extractable 1U	RAL 7035	without front plate
415203	OV-S extractable 1U	RAL 9005	without front plate
415204	OV-S extractable 1U	stainless steel	without front plate
415245	Folding mechanism for OV-S 1U		

FIBRE OPTIC PANELS & ENCLOSURES

OV-AT / OV-S 1U accessories

Front plates, cable entries, strain reliefs



Fibre optic patch panel OV-AT 1U



Fibre optic patch panel OV-S 1U

	Article No.	Description	Colour (similar to)
	416951	Front plate for 12x SCD/LCQ	RAL 7035
	415241	Front plate 12x SCD/LCQ angled	RAL 7035
	416952	Front plate for 24x SCD/LCQ	RAL 7035
	415247	Front plate 12x SC/LCD angled	RAL 7035
	416953	Front plate for 24x SC or LSH	RAL 7035
	416954	Front plate for 24x ST or FC/PC	RAL 7035
	417279	Front plate for 24x LCD (offset design)	RAL 7035
	419051	Front plate for 24x LSH Compact (LSH-C)	RAL 7035
	416955	Front plate for insertion of 2 partial front plates	RAL 7035
	416956	Partial front plate for 12x LSH (1-12) for Article No. 416955	RAL 7035
	416968	Partial front plate for 12x LSH (13-24) for Article No. 416955	RAL 7035
	416957	Partial front plate for 6x SCD/LCQ for Article No. 416955	RAL 7035
	416967	Partial front plate for 12x ST or FC/PC for Article No. 416955	RAL 7035
	416958	Blank partial front plate for Article No. 416955	RAL 7035
	415249	Front plate 12x SC angled	RAL 9005
	417374	Front plate for 24x SC or LSH	RAL 9005
	417377	Front plate for 24x ST or FC/PC	RAL 9005
	415310	Front plate for 24x LCD (offset design)	RAL 9005
	417378	Front plate for 12x SCD/LCQ	RAL 9005
	415248	Front plate 12x SCD/LCQ angled	RAL 9005
	417379	Front plate for 24x SCD/LCQ	RAL 9005
	417868	Front plate for 24x SCD/LCQ	Stainless steel
	417550	Angled cable entry M25*	Steel
	417559	Angled cable entry M20*	Steel
	416994	Straight cable entry M20 + M25	Steel
	415308	Straight cable entry M20 + M25*	Steel
	418650	Straight cable entry 1x 20 mm + 2x 15 mm*	Steel
	418652	Angled cable entry 2x 15 mm*	Steel
	415208	Angled cable entry 2x M20*	Steel
	417857	Strain relief M20	Steel
	417858	Strain relief M25	Steel

* Pre-stamped cables entries can be opened as necessary.

Copper

Fibre Optics

Cabinets & Racks

Data Centre

Wireless

Multimedia

General Information

Zubehör OV-A, OV-AT 1Ue 0612/e

FO patch panel OV-A / OV-AT

19"/2U, unloaded

exchangeable front plate, extractable or telescopic, depth-adjustable mounting



Fibre optic patch panel OV-AT, 19"/2U, without front plate, extractable or with telescopic slides, depth-adjustable mounting

PRODUCT INFORMATION

APPLICATION	For the termination of fibre optic cables (breakout, loose tube) - maximum of 192 fibres. Applicable with a wide range of front plates / connector systems (see OV-A / OV-AT 2U accessories).	
CONSTRUCTION	Housing:	metallic, extractable drawer (OV-A) or drawer with telescopic slides (OV-AT), both with locking mechanism
	Rack mounting:	depth-adjustable mounting of box (5 steps, maximum 50 mm) due to the adjustable 19" mounting brackets
	Colour mounting brackets (variants):	similar to RAL 7035 or stainless steel
	Imprint:	numbers (silk screen printing) on frontplate (to be ordered separately)
	Capacity:	up to 192 fibres
	Strain relief:	with cable tie and screwed cable gland or cable distributor
	Cable entry:	rear left and right (the openings are covered with a blind cover and a straight cable entry plate with M20 and M25 slotted holes - Article No. 417561)
	Dimensions:	19"/2U, depth 254 mm
CONNECTOR SYSTEM	Adapter:	ST, FC, SCD, SC, LSH, LCD (dependent on front plate)
SCOPE OF DELIVERY	Box, strain relief with M25 (2U) cable gland, splice tray holder and adhesive fibre fixation (3 pcs.)	
	Please order the front plate separately.	

Article No.	Description	Colour (similar to)	Note
416960	OV-A extractable 2U	RAL 7035	without front plate
416965	OV-AT telescopic 2U	RAL 7035	without front plate
416977	OV-AT telescopic 2U	Stainless steel	without front plate
416959	Telescopic slides for upgrading OV-A to OV-AT		
418098	Label for OV-A and OV-AT, aluminium, length 420 mm		





















FIBRE OPTIC PANELS & ENCLOSURES

OV-A / OV-AT 2U accessories

Front plates, cable entries, strain reliefs



Fibre optic patch panel OV-AT 2U

	Article No.	Description	Colour (similar to)	
Copper		416961	Front plate for 24x SCD/LCQ	RAL 7035
		416976	Front plate for 24x SCD/LCQ	Stainless steel
		416962	Front plate for 48x SC or LSH	RAL 7035
		416963	Front plate for 48x ST	RAL 7035
		417882	Front plate for 48x SCD/LCQ	RAL 7035
		417299	Front plate for 48x LCD (offset design)	RAL 7035
		419052	Front plate 48x LSH Compact (LSH-C)	RAL 7035
		416966	Front plate for insertion of 4 partial front plates	RAL 7035
Fibre Optics		416956	Partial front plate for 12x LSH (1-12) for No. 416966	RAL 7035
		416968	Partial front plate for 12x LSH (13-24) for No. 416966	RAL 7035
		416957	Partial front plate for 6x SCD/LCQ for No. 416966	RAL 7035
		416967	Partial front plate for 12x ST or FC/PC for No. 416966	RAL 7035
		416958	Blank partial front plate for No. 416966	RAL 7035
Cabinets & Racks		417560	Angled cable entry M25	Steel
		417562	Angled cable entry M20	Steel
Data Centre		417561	Straight cable entry M20 + M25	Steel
		418651	Straight cable entry 1x 20 mm + 2x 15 mm	Steel
Wireless		418654	Angled cable entry 2x 14 mm	Steel
		415209	Angled cable entry 2x M20	Steel
Multimedia		417857	Strain relief M20	Steel
		417858	Strain relief M25	Steel

Zubehör OV-A, OV-AT 1HE 0612/e

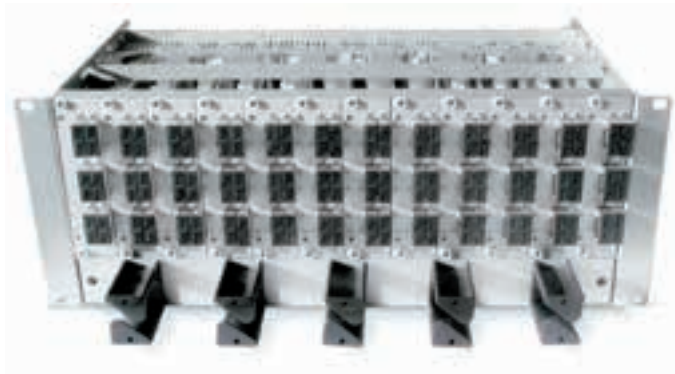

FO subrack OV-BG 4U, configuration example with 12 slide-in modules SCD, cassette for excess cable length and support brackets

Front plate for slide-in modules:



for Article No. 416908 6x SCD/LCQ	for Article No. 416909 12x SC und LSH	for Article No. 417212 12x LCD
---	---	--------------------------------------

PRODUCT INFORMATION

APPLICATION	Modular solution for the termination of multiple-fibre cables - maximum of 288 fibres. Suitable for a wide range of applications - depending on the type of FO slide-in modules or front plates (maximum of 12).	
DESCRIPTION	Housing:	Solid aluminium profile with side walls, integrated 19"/3U fixation on the front and pre-assembled guide rail for FO slide-in modules
	Colour:	Aluminium, anodised
	Capacity:	84HP, up to 12 slide-in modules or front plates 7HP/3U
	Cable entry:	from rear, via the cassette for excess cable length (only for 4U version)
	Support brackets:	can be mounted in front of cassette for excess cable length
	Dimensions:	19"/3U, depth 225 mm 19"/4U, depth 295 mm
CONNECTOR SYSTEM	ST, SCD, SC, LCD, LSH	Pre-assembled FO slide-in modules with coloured pigtails (IEC 60304), stripped and stored in splice tray
SCOPE OF DELIVERY	19"/4U variant delivered with cassette for excess cable length and 5 support brackets	

Article No.	Description	Dimensions
416980	FO subrack (unloaded)	84HP/3U
416907	FO subrack (unloaded)	84HP/4U with cassette for excess cable length
416908 *	FO slide-in module for 6x SCD (fastened by screws)	7HP/3U with splice tray, without adapters/pigtails
417212 *	FO slide-in module for 12x LCD (snap-in adapters)	7HP/3U with splice tray, without adapters/pigtails
416909 *	FO slide-in module for 12xSC/LSH (fastened by screws)	7HP/3U with splice tray, without adapters/pigtails
416981	Blank front plate	7HP/3U for FO subrack

* All unloaded FO slide-in modules (without adapters/pigtails) are delivered with a splice tray (already mounted) which provides an excess fibre length section and a cover.

Article No.	Description		
417350 *	FO slide-in module	loaded with 12x LCD adapter (beige) and 24 LC pigtails	G50/125 OM2
417351 *	FO slide-in module	loaded with 6x LCD adapter (beige) and 12 LC pigtails	G50/125 OM2
417352 *	FO slide-in module	loaded with 6x LCD adapter (blue) and 12 LC pigtails	E09/125 OS2
417353 *	FO slide-in module	loaded with 12x LCD adapter (turquoise) and 24 LC pigtails	G50/125 OM3
417354 *	FO slide-in module	loaded with 12x LCD adapter (blue) and 24 LC pigtails	E09/125 OS2
417355 *	FO slide-in module	loaded with 6x LCD adapter (turquoise) and 12 LC pigtails	G50/125 OM3
417356	FO slide-in module	loaded with 6x SCD adapter (beige) and 12 SC pigtails	G50/125 OM2
417357	FO slide-in module	loaded with 6x SCD adapter (turquoise) and 12 SC pigtails	G50/125 OM3
417358	FO slide-in module	loaded with 6x SCD adapter (blue) and 12 SC pigtails	E09/125 OS2

All loaded FO slide-in modules are delivered with splice holder, splice protection and excess fibre length section. Pigtails (colour code: IEC 60304) are ready for splicing.

* FO slide-in modules LCD are based on article no. 417212 for snap-in adapters.

Please ask for further versions of our pre-assembled FO slide-in modules!

FO patch panel OV-S

19"/1U, loaded

splice box with adapters and pigtails



Fibre optic splice box OV-S, 19"/1U, extractable, configuration example with 24 SCD adapters and 48 pigtails

PRODUCT INFORMATION

APPLICATION	For the termination of fibre optic cables - maximum of 96 fibres. Loaded with FO adapters, ready for splicing, with prepared pigtails (per 2 m, colour code: IEC 60304).	
DESCRIPTION	Housing:	metal sheet, black, extractable drawer with locking mechanism, box allows for depth-adjustable mounting (5 steps, maximum 50 mm)
	Colour (front):	similar to RAL 7035, similar to RAL 9005 or stainless steel
	Imprint:	numbers (silk screen printing) on frontplate
	Capacity:	up to 96 fibres
	Strain relief:	with cable tie and screwed cable gland (M20)
	Cable entry:	rear left and right (two big openings, covered with straight cable entry plates: Article No. 415308 with pre-stamped cable entries M20 and M25 and Article No. 418650 with pre-stamped cable entries 2x M15, 1x M20 – these pre-stamped holes can be opened as necessary)
	Dimensions:	19"/1U, depth 300 mm
CONNECTOR SYSTEM	Adapter:	SCD, LCD, LSH, ST
SCOPE OF DELIVERY	Splice box with - two straight cable entries - one screwed cable gland M20 - coloured pigtails with measurement report - FO adapters, fastened by screws - splice trays with cover and support Delivery without splicing protection	
NOTES	Variants on request. Upgradable with an optional folding mechanism (Article No. 415245).	

FO patch panel OV-S

19"/1U, loaded

splice box with adapters and pigtails

PRODUCT INFORMATION

Article No.	Description	Loaded with	
415210	Splice box OV-S, extractable, 1U	6x LCD adapter, blue polymer housing	with ceramic sleeve and 12 LC pigtails 2m E09/125µm OS2
415211	Splice box OV-S, extractable, 1U	6x LCD adapter, beige polymer housing	with ceramic sleeve and 12 LC pigtails 2m G50/125µm OM2
415212	Splice box OV-S, extractable, 1U	6x LCD adapter, turquoise polymer housing	with ceramic sleeve and 12 LC pigtails 2m G50/125µm OM3
415213	Splice box OV-S, extractable, 1U	6x LCD adapter, violet polymer housing	with ceramic sleeve and 12LC pigtails 2m G50/125µm OM4
415214	Splice box OV-S, extractable, 1U	12x LCD adapter, blue polymer housing	with ceramic sleeve and 24 LC pigtails 2m E09/125µm OS2
415215	Splice box OV-S, extractable, 1U	12x LCD adapter, beige polymer housing	with ceramic sleeve and 24 LC pigtails 2m G50/125µm OM2
415216	Splice box OV-S, extractable, 1U	12x LCD adapter, turquoise polymer housing	with ceramic sleeve and 24 LC pigtails 2m G50/125µm OM3
415217	Splice box OV-S, extractable, 1U	12x LCD adapter, violet polymer housing	with ceramic sleeve and 24 LC pigtails 2m G50/125µm OM4
415218	Splice box OV-S, extractable, 1U	24x LCD adapter, blue polymer housing	with ceramic sleeve and 48LC pigtails 2m E09/125µm OS2
415219	Splice box OV-S, extractable, 1U	24x LCD adapter, beige polymer housing	with ceramic sleeve and 48 LC pigtails 2m G50/125µm OM2
415220	Splice box OV-S, extractable, 1U	24x LCD adapter, turquoise polymer housing	with ceramic sleeve and 48 LC pigtails 2m G50/125µm OM3
415221	Splice box OV-S, extractable, 1U	24x LCD adapter, violet polymer housing	with ceramic sleeve and 48 LC pigtails 2m G50/125µm OM4
415275	Splice box OV-S, extractable, 1U	24x LCQ adapter, blue polymer housing	with ceramic sleeve and 96 LC pigtails 2m E09/125µm OS2
415299	Splice box OV-S, extractable, 1U	24x LCQ adapter, beige polymer housing	with ceramic sleeve and 96 LC pigtails 2m G50/125µm OM2
415298	Splice box OV-S, extractable, 1U	24x LCQ adapter, turquoise polymer housing	with ceramic sleeve and 96 LC pigtails 2m G50/125µm OM3
415295	Splice box OV-S, extractable, 1U	24x LCQ adapter, violet polymer housing	with ceramic sleeve and 96 LC pigtails 2m G50/125µm OM4
415222	Splice box OV-S, extractable, 1U	6x SCD adapter, blue polymer housing	with ceramic sleeve and 12 SC pigtails 2m E09/125µm OS2
415223	Splice box OV-S, extractable, 1U	6x SCD adapter, beige polymer housing	with PB sleeve and 12 SC pigtails 2m G50/125µm OM2
415224	Splice box OV-S, extractable, 1U	6x SCD adapter, turquoise polymer housing	with PB sleeve and 12 SC pigtails 2m G50/125µm OM3
415225	Splice box OV-S, extractable, 1U	6x SCD adapter, violet polymer housing	with PB sleeve and 12 SC pigtails 2m G50/125µm OM4
415226	Splice box OV-S, extractable, 1U	12x SCD adapter, blue polymer housing	with ceramic sleeve and 24 SC pigtails 2m E09/125µm OS2
415227	Splice box OV-S, extractable, 1U	12x SCD adapter, beige polymer housing	with PB sleeve and 24 SC pigtails 2m G50/125µm OM2
415228	Splice box OV-S, extractable, 1U	12x SCD adapter, turquoise polymer housing	with PB sleeve and 24 SC pigtails 2m G50/125µm OM3
415229	Splice box OV-S, extractable, 1U	12x SCD adapter, violet polymer housing	with PB sleeve and 24 SC pigtails 2m G50/125µm OM4
415230	Splice box OV-S, extractable, 1U	24x SCD adapter, blue polymer housing	with ceramic sleeve and 48 SC pigtails 2m E09/125µm OS2
415231	Splice box OV-S, extractable, 1U	24x SCD adapter, beige polymer housing	with PB sleeve and 48 SC pigtails 2m G50/125µm OM2
415232	Splice box OV-S, extractable, 1U	24x SCD adapter, turquoise polymer housing	with PB sleeve and 48 SC pigtails 2m G50/125µm OM3
415233	Splice box OV-S, extractable, 1U	24x SCD adapter, violet polymer housing	with PB sleeve and 48 SC pigtails 2m G50/125µm OM4
415234	Splice box OV-S, extractable, 1U	6x ST adapter, metal housing	with ceramic sleeve and 6 ST pigtails 2m E09/125µm OS2
415235	Splice box OV-S, extractable, 1U	6x ST adapter, metal housing	with ceramic sleeve and 6 ST pigtails 2m G50/125µm OM2
415236	Splice box OV-S, extractable, 1U	6x ST adapter, metal housing	with ceramic sleeve and 6 ST pigtails 2m G50/125µm OM3
415238	Splice box OV-S, extractable, 1U	12x ST adapter, metal housing	with ceramic sleeve and 12 ST pigtails 2m E09/125µm OS2
415239	Splice box OV-S, extractable, 1U	12x ST adapter, metal housing	with ceramic sleeve and 12 ST pigtails 2m G50/125µm OM2
415240	Splice box OV-S, extractable, 1U	12x ST adapter, metal housing	with ceramic sleeve and 12 ST pigtails 2m G50/125µm OM3
415242	Splice box OV-S, extractable, 1U	24x ST adapter, metal housing	with ceramic sleeve and 24ST pigtails 2m E09/125µm OS2
415243	Splice box OV-S, extractable, 1U	24x ST adapter, metal housing	with ceramic sleeve and 24 ST pigtails 2m G50/125µm OM2
415244	Splice box OV-S, extractable, 1U	24x ST adapter, metal housing	with ceramic sleeve and 24 ST pigtails 2m G50/125µm OM3

All pigtails are coloured (in accordance with IEC 60304), stripped and stored in splice tray

FO patch panel OV-S

19"/1U, loaded

breakout box with adapters



Fibre optic breakout box OV-S, 19"/1U, extractable, configuration example with 6 SCD adapters

PRODUCT INFORMATION

APPLICATION	For the termination of pre-assembled fibre optic cables - maximum of 96 fibres. Loaded with a maximum of 12 / 24 FO adapters.	
CONSTRUCTION	Housing:	metal sheet, black, extractable drawer with locking mechanism, box allows for depth-adjustable mounting (5 steps, maximum 50 mm)
	Colour (front):	similar to RAL 7035, similar to RAL 9005 or stainless steel
	Imprint:	numbers (silk screen printing) on frontplate
	Capacity:	up to 96 fibres
	Strain relief:	with cable tie and screwed cable gland
	Cable entry:	rear left and right (two big openings, covered with straight cable entry plates: Article No. 415308 with pre-stamped cable entries M20 and M25 and Article No. 418650 with pre-stamped cable entries 2x M15, 1x M20 – these pre-stamped holes can be opened as necessary)
	Dimensions:	19"/1U, depth 300 mm
CONNECTOR SYSTEM	Adapter:	ST, SCD, LCD, LSH
SCOPE OF DELIVERY	Breakout box with - two straight cable entries - FO adapters, fastened by screws	
NOTES	Variants on request. Upgradable with an optional folding mechanism (Article No. 415245).	

FO patch panel OV-S

19"/1U, loaded

breakout box with adapters, without pigtails

PRODUCT INFORMATION

Article No.	Description	Loaded with
415250	Breakout box OV-S, extractable, 1U	6x LCD SM adapter, blue polymer housing, with ceramic sleeve
415251	Breakout box OV-S, extractable, 1U	6x LCD MM adapter, beige polymer housing, with ceramic sleeve
415252	Breakout box OV-S, extractable, 1U	6x LCD MM adapter, turquoise polymer housing, with ceramic sleeve
415253	Breakout box OV-S, extractable, 1U	6x LCD MM adapter, violet polymer housing, with ceramic sleeve
415254	Breakout box OV-S, extractable, 1U	12x LCD SM adapter, blue polymer housing, with ceramic sleeve
415255	Breakout box OV-S, extractable, 1U	12x LCD MM adapter, beige polymer housing, with ceramic sleeve
415256	Breakout box OV-S, extractable, 1U	12x LCD MM adapter, turquoise polymer housing, with ceramic sleeve
415257	Breakout box OV-S, extractable, 1U	12x LCD MM adapter, violet polymer housing, with ceramic sleeve
415258	Breakout box OV-S, extractable, 1U	24x LCD SM adapter, blue polymer housing, with ceramic sleeve
415259	Breakout box OV-S, extractable, 1U	24x LCD MM adapter, beige polymer housing, with ceramic sleeve
415260	Breakout box OV-S, extractable, 1U	24x LCD OM3, turquoise polymer housing, with ceramic sleeve
415261	Breakout box OV-S, extractable, 1U	24x LCD OM4, violet polymer housing, with ceramic sleeve
415207	Breakout box OV-S, extractable, 1U	24x LCQ SM adapter, blue polymer housing, with ceramic sleeve
415278	Breakout box OV-S, extractable, 1U	24x LCQ MM adapter, beige polymer housing, with ceramic sleeve
415280	Breakout box OV-S, extractable, 1U	24x LCQ MM adapter, turquoise polymer housing, with ceramic sleeve
415296	Breakout box OV-S, extractable, 1U	24x LCQ MM adapter, violet polymer housing, with ceramic sleeve
415262	Breakout box OV-S, extractable, 1U	6x SCD SM adapter, blue polymer housing, with ceramic sleeve
415263	Breakout box OV-S, extractable, 1U	6x SCD MM adapter, beige polymer housing, with PB sleeve
415264	Breakout box OV-S, extractable, 1U	6x SCD MM adapter, turquoise polymer housing, with PB sleeve
415265	Breakout box OV-S, extractable, 1U	6x SCD MM adapter, violet polymer housing, with PB sleeve
415266	Breakout box OV-S, extractable, 1U	12x SCD SM adapter, blue polymer housing, with ceramic sleeve
415267	Breakout box OV-S, extractable, 1U	12x SCD MM adapter, beige polymer housing, with PB sleeve
415268	Breakout box OV-S, extractable, 1U	12x SCD MM adapter, turquoise polymer housing, with PB sleeve
415269	Breakout box OV-S, extractable, 1U	12x SCD MM adapter, violet polymer housing, with PB sleeve
415270	Breakout box OV-S, extractable, 1U	24x SCD SM adapter, blue polymer housing, with ceramic sleeve
415271	Breakout box OV-S, extractable, 1U	24x SCD MM adapter, beige polymer housing, with PB sleeve
415272	Breakout box OV-S, extractable, 1U	24x SCD MM adapter, turquoise polymer housing, with PB sleeve
415273	Breakout box OV-S, extractable, 1U	24x SCD MM adapter, violet polymer housing, with PB sleeve
415274	Breakout box OV-S, extractable, 1U	6x ST SM+MM Adapter metal housing, with ceramic sleeve
415276	Breakout box OV-S, extractable, 1U	12x ST SM+MM adapter, metal housing, with ceramic sleeve
415279	Breakout box OV-S, extractable, 1U	24x ST SM+MM adapter, metal housing, with ceramic sleeve

Fibre distribution box OV-W
wall mounted



Fig. 1: Fibre distribution box OV-W



Fig. 2:
Cable entry
2 plates and 2 brush strips



Fig. 3:
Patch panel
for 12x SC-D



Fig. 4:
Patch panel
for 48x SC

Fig. 5:
Splice tray
take-up

PRODUCT INFORMATION

APPLICATION For the distribution of the fibre optic backbone cabling to the horizontal cabling. Suitable for splice connections or removable connections.

DESCRIPTION

Housing: steel plate 1.5 mm, removable front door and side walls
 Colour: RAL 7035
 Patch panels: available for 48 adapters SCD, SC, ST and LCD (other on request)
 Strain relief: with cable tie, screwed cable gland or snap-in
 Cable entry: on four sides possible
 Dimensions: H x W x D: 300 x 300 x 85 mm

CONNECTOR SYSTEM ST/FC, SCD, SC/LSH/LCD

SCOPE OF DELIVERY Fibre distribution box OV-W with lock and two keys, splice tray holder for four cassettes, fastening set

Article No.	Fig.	Description	PU
416904	1	FO wall mount distribution box OV-W, 300 x 300 x 85 mm (unloaded, with splice tray holder)	1 pc.
416905	2	Cable entry with 2 plates and 2 brush strips	1 set
416906	3	Patch panel for 12x SCD	1 pc.
416979	4	Patch panel for 48x SC	1 pc.
416989	-	Patch panel für 48x ST	1 pc.
416988	5	Splice tray take-up	4 pcs.

Fibre distribution box OV-W

wall mounted

for 2 patch panels 2U



Fig. 1: Fibre distribution box OV-W



Fig. 2: Angle bracket set for patch panels



Fig. 3: Brush strip set



Fig. 4: Splice tray holder



Fig. 5: Splice tray take-up

PRODUCT INFORMATION

APPLICATION	For the distribution of the fibre optic backbone cabling to the horizontal cabling. For splice connections or removable connections.	
DESCRIPTION	Housing:	steel plate 1.5 mm, with removable front door and side walls, can be extended
	Colour:	RAL 7035
	Patch panels:	available for 48 adapters SCD, SC, ST and LCD each (other on request)
	Strain relief:	with cable tie, screwed cable gland or snap-in
	Cable entry:	on four sides possible
	Dimensions:	600 x 425 x 220 mm
CONNECTOR SYSTEM	ST/FC, SCD, SC/LSH/LCD	
SCOPE OF DELIVERY	Fibre distribution box OV-W with lock and two keys, fastening set	

Article No.	Fig.	Description	PU
416900	1	FO wall mount distribution box 600 x 425 x 220 mm	(unloaded) 1 pc.
416901	2	Angle bracket set for patch panels	for 416900 2 pcs.
416902	3	Brush strip set	for 416900 2 pcs.
417396	-	Cable entry set PG 16 / PG 21	for 416900 2 pcs.
416903	-	Patch panel 2U for 24x SCD	for 416900 1 pc.
418983	-	Patch panel 2U for 48x ST	for 416900 1 pc.
416997	4	Splice tray holder for 12 cassettes	for 416900 1 pc.
416988	5	Splice-tray take-up	for 416900 and 416904 4 pcs.

FIBRE OPTIC ACCESSORIES

Management panels & cable shelves 19"/1U

in different versions



Management panel 19"/1U, version made of stainless steel, with 5 support brackets

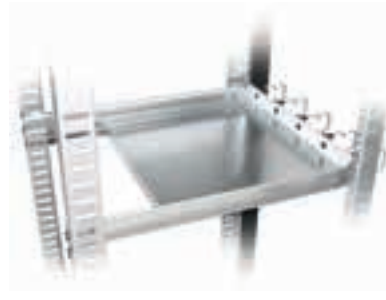

19" cable shelf with management panel



19" cable shelf with cable feedthrough panel and strip

PRODUCT INFORMATION

APPLICATION

Management panels 19"/1U are suitable for the routing of copper and fibre optic cables, particularly suitable for patch cords in racks or cabinets with 19" mounting angles and rails.

Cable shelves fulfil the same function, particularly for multiple (trunk) cables.

DESCRIPTION

The basic management panels 19"/1U are available in three versions: a) stainless steel, b) black or c) grey.

These panels come without support brackets. They can be fitted with 5 support brackets in the required dimension. Please order the support brackets separately!

There are labelling strips for complete management panels with support brackets available:

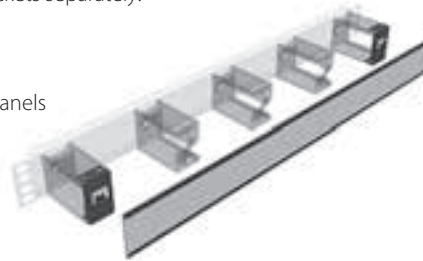

Article No.	Description	Colour/Material	PU
1411480	Support bracket 30 mm	plastic, black	1 pc.
1411481	Support bracket 75 mm	metal	1 pc.
1411482	Support bracket 110 mm	metal	1 pc.
1411604	Management panel 19"/1U for 5 support brackets (delivery without brackets)	RAL 7035	1 pc.
1407689	Management panel 19"/1U for 5 support brackets (delivery without brackets)	RAL 9005	1 pc.
418200	Management panel 19"/1U for 5 support brackets (delivery without brackets)	stainless steel, blank	1 pc.
401240	19" blank plate, 1U	RAL 7035	1 pc.
401241	19" blank plate, 1U	RAL 9005	1 pc.
401242	19" blank plate, 1U	stainless steel, blank	1 pc.
401243	19" blank plate, 2U	RAL 7035	1 pc.
401244	19" blank plate, 2U	RAL 9005	1 pc.
401245	19" blank plate, 2U	stainless steel, blank	1 pc.
401247	Cable feedthrough panel with strip 19"/1U	RAL 7035	1 pc.
401248	Cable feedthrough panel with strip 19"/1U	RAL 9005	1 pc.
401249	Cable feedthrough panel with strip 19"/1U	stainless steel, blank	1 pc.
400300	19" cable shelf, depth adjustable due to slide rails (from 520 mm up to 850 mm) (only mountable with a management panel or cable feedthrough panel; rear side 19" fixation necessary)		1 pc.
470038	Labelling strip (for complete management panel with bracket type 1411480)		1 pc.
470039	Labelling strip (for complete management panel with bracket types 1411481, 1411482)		1 pc.

Rangierpanel 1HE 0414/e

Splicing accessories & cable glands



Splice tray



Splice holder



Splice protection



Cable gland

PRODUCT INFORMATION

Accessories

Article No.	Description	PU
1411150	Splice tray without cover	1 pc.
1411151	Splice tray cover	1 pc.
1411152	Splice holder for up to 12 splices (crimp technology)	1 pc.
1411153	Splice holder for up to 6 splices (heat shrink technology)	1 pc.
418649	Splice protection (crimp technology)	1 pc.
1401581	Splice protection (shrink technology)	100 pcs.
416996	Splice kit with 12x splice protection (crimp technology) and splice tray cover	1 set
1411154	Fibre strain relief for splice tray	1 pc.

Cable glands

Article No.	Type	Article	Diameter	Clamping range
418165	M16	Cable gland	16 mm	4-8 mm
418166	M16	Locknut		
418160	M20	Cable gland	20 mm	6-12 mm
418161	M20	Locknut		
418167	M20	Metal cable gland	20 mm	6-12 mm
418168	M20	Metal locknut		
418162	M25	Cable gland	25 mm	9-17 mm
418163	M25	Locknut		

Launch cable box
for OTDR testing



OTDR launch cable box

PRODUCT INFORMATION

APPLICATION Launch cables are necessary for optical performance testing (measurement) of fibre optic connections with an OTDR.

DESCRIPTION

Housing: PVC hard-top case (275 x 225 x 80 mm)
with spare tray for FO adapters and other accessories

Contents: optionally with 3 different fibre types

The fibres are wound strain-relieved. About 2.5 m of the fibres are protected by a hollow tube.

CONNECTOR SYSTEM ST, SC, LSH, LC, FC/PC, HRL variants and other (to be defined)

Article No.	Description	Information
416890	Launch cable box with 100 m G50+G62 and 1000 m E09	connector to be defined
416891	Launch cable box with 1000 m E09	connector to be defined
416892	Launch cable box with 100 m G50	connector to be defined
416893	Launch cable box with 100 m G62	connector to be defined

Network racks SP

19"/42U

with glass front door



Network rack SP with glass front door and plinth

PRODUCT INFORMATION

APPLICATION 19" network rack

FEATURES High-grade 19" network cabinet in two sizes
 Can be very flexibly assembled, configured and fully dismantled
 Can be bayed together side-by-side
 Protection rating IP20 (optional up to IP54)
 Load capacity up to 1000 kg

DIMENSIONS 19"/42U, H x W x D: 2100 x 800 x 800 mm
 19"/42U, H x W x D: 2100 x 600 x 800 mm

DESCRIPTION

- Basic frame made of steel profiles, pegged with corner pieces (screwed)
- 4 mounting angles 19" (482.6 mm)
- 2 depth members on either side for depth adjustable installation of the mounting angles
- Front door with 3 mm toughened safety glass and standard lever handle / 2-point locking system
- Rear door with lever handle
- 2 removable side walls with safety lock
- One-piece bottom
- One-piece roof, ready for strip (enclosed) and with 6 knockouts for fans
- Plinth 100 mm (removable), passively ventilated, with levelling feet
- 2 C mounting profiles for mounting in width
- 2 C mounting profiles for depth adjustable mounting
- Set for protective earthing conductor installation
- 19" fastening set



DELIVERY Mounted and packed

Article No.	Description	Height	Width	Depth (mm)	Colour
190822	Network rack SP, 19"/42U	2100	800	800	light grey, RAL 7035
190823	Network rack SP, 19"/42U	2100	600	800	light grey, RAL 7035
190835	Network rack SP, 19"/42U, basic frame	2100	800	800	light grey, RAL 7035

Other dimensions on request.

For accessories please see page 284

Network racks PX

19" 25U or 43U

with glass front door



Network Rack PX with glass front door and integrated plinth

PRODUCT INFORMATION

APPLICATION	19" network rack
FEATURES	<p>Cost-efficient 19" network cabinet in three sizes</p> <p>Can be very flexibly assembled, configured and fully dismantled</p> <p>Can be bayed together side-by-side</p> <p>Protection rating IP20</p> <p>Load capacity up to 700 kg</p>
DIMENSIONS	<p>19"/25U, H x W x D: 1300 x 600 x 800 mm</p> <p>19"/43U, H x W x D: 2100 x 800 x 800 mm</p> <p>19"/43U, H x W x D: 2100 x 800 x 1000 mm</p>
DESCRIPTION	<ul style="list-style-type: none"> - Basic frame made of steel, multi-folded, screwed together via the roof and the integrated plinth - 4 mounting angles 19" (482.6 mm) - 2 depth members on either side for depth adjustable installation of the mounting angles - Front door (inside) with 3 mm toughened safety glass and standard lever handle - One-piece rear door (inside) with lever handle - 2 removable side walls, each with two cam locks - One-piece roof with knock-outs for strips, for cable entries (at the rear and at both sides) and/or for 6 axial fans - Open bottom - Plinth 100 mm (fix), passively ventilated, with levelling feet - Set for protective earthing conductor installation - 19" fastening set
DELIVERY	Mounted and packed

Article No.	Description	Height	Width	Depth (mm)	Colour
309214	Network rack PX, 19"/25U	1300	600	800	light grey, RAL 7035
309215	Network rack PX, 19"/43U	2100	800	800	light grey, RAL 7035
309216	Network rack PX, 19"/43U	2100	800	1000	light grey, RAL 7035

Other dimensions on request.

For accessories please see page 284

Server racks SP

19"/24U or 42U

with perforated front and rear door



Server rack SP with perforated doors

PRODUCT INFORMATION

APPLICATION	19" server rack
FEATURES	<p>High-grade 19" server cabinet in three sizes Can be very flexibly assembled, configured and fully dismantled Can be bayed together side-by-side Protection rating IP20 Load capacity up to 1000 kg</p>
DIMENSIONS	<p>19"/42U, H x W x D: 2100 x 800 x 1000 mm 19"/42U, H x W x D: 2100 x 600 x 1000 mm 19"/24U, H x W x D: 1300 x 600 x 1000 mm</p>
DESCRIPTION	<ul style="list-style-type: none"> - Basic frame made of steel profiles, pegged with corner pieces (screwed) - 4 mounting angles 19" (482.6 mm) - 2 depth members on either side for depth adjustable installation of the mounting angles - Perforated front door (passively ventilated) with standard lever handle / 2-point locking system - Perforated rear door (passive ventilation) with lever handle - 2 removable side walls with safety lock - One-piece roof, ready for strip (enclosed) and with 6 knockouts for fans - Plinth 100 mm (removable), passively ventilated, with levelling feet - Set for protective earthing conductor installation - 19" fastening set
DELIVERY	Mounted and packed



Article No.	Description	Height	Width	Depth (mm)	Colour
190825	Server rack SP, 19"/42U	2100	800	1000	black, RAL 9005
190826	Server rack SP, 19"/42U	2100	600	1000	black, RAL 9005
190827	Server rack SP, 19"/24U	1300	600	1000	black, RAL 9005

For accessories please see page 284

Serverschrank SP 0814/e

DATA CABINETS & RACKS

Server racks SP

19"/24U and 42U

with glass front door, perforated rear door



Server rack SP with glass front door and perforated rear door

PRODUCT INFORMATION

APPLICATION

19" server rack

FEATURES

High-grade 19" server cabinet in four sizes
Can be very flexibly assembled, configured and fully dismantled
Can be bayed together side-by-side
Protection rating IP20
Load capacity up to 1000 kg

DIMENSIONS

19"/42U, H x W x D: 2100 x 800 x 800 mm
19"/42U, H x W x D: 2100 x 800 x 1000 mm (version with circumferentially perforated glass front door)
19"/42U, H x W x D: 2100 x 600 x 1000 mm
19"/24U, H x W x D: 1300 x 600 x 1000 mm

DESCRIPTION

- Basic frame made of steel profiles, pegged with corner pieces (screwed)
- 4 mounting angles 19" (482.6 mm)
- 2 depth members on either side for depth adjustable installation of the mounting angles
- Front door with 3 mm toughened safety glass and standard lever handle / 2-point locking system
- Perforated rear door (passive ventilation) with lever handle
- 2 removable side walls with safety lock
- One-piece roof, ready for strip (enclosed) and with 6 knockouts for fans
- Plinth 100 mm (removable), passively ventilated, with levelling feet
- Set for protective earthing conductor installation
- 19" fastening set



DELIVERY

Mounted and packed

Article No.	Description	Height	Width	Depth (mm)	Colour
309217	Server rack SP, 19"/42U	2100	800	800	light grey, RAL 7035
309218	Server rack SP, 19"/42U	2100	800	1000	light grey, RAL 7035
309219	Server rack SP, 19"/42U	2100	600	1000	light grey, RAL 7035
309220	Server rack SP, 19"/24U	1300	600	1000	light grey, RAL 7035

For accessories please see page 284

Cold Aisle Containment Systems

For network and server racks SP and PX



Cold Aisle Containment Systems (CACS) meet the two most significant thermal challenges in data centres

- preventing hot air from recirculation
- preventing high losses of cold air

Arguments for CACS:

- Economical, energy efficient solution
- Minimal effort, easy installation of roof and doors
- Cooling capacity through false floor can be adjusted according to the demand
- Cold Aisle Containment provides physical separation between cold and hot aisles
- Scalable with additional cooling units within the rack rows when needed
- Optionally expandable solution (cold aisle *and* hot aisle containment)

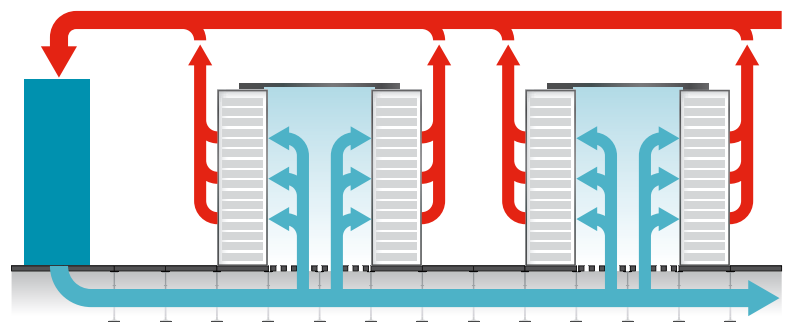

Example for cooling through the raised floor and for a containment of cold aisles

suitable for up to 12 kW per rack

Effective cold-air routing

The purpose of a cold aisle containment is the complete structural separation of the cold air in front of the servers and the hot air behind the servers.

To achieve this, data centres are equipped with raised floors, rack rows are aligned face to face, and the corridors between them are fitted with ceilings and sliding doors to enclose the cold aisles.

The cold air directed through the false floor is exclusively released into cold aisles. Containment of the cold aisles (and the hot aisles) facilitates the targeted routing of cold air from the raised floor to the hotspots in the cabinets - and of warm air back into the cooling cycle in the rear of the racks. In addition, it effectively prevents warm and cold in the data centre from mixing.

Cutting costs

Cold Aisle Containment Systems are a globally recognised and proven solution for reducing the energy needs and cutting costs while achieving the required cooling performance in data centres. When rack extensions are necessary, the doors can simply be reattached to the end cabinets, and additional ceiling panels can be added.

If you are interested in a consultation or in developing a project please do not hesitate to contact us. We would be happy to give you more information!

For contact details please see the catalogue's back cover. For more information please visit our website www.cabling.datwyler.com.

DATA CABINETS & RACKS

Wall mounted cabinets

19"/9U, 12U or 15U

Mini rack

19"/18U



19" wall mounted cabinets

19" mini rack with levelling feet

PRODUCT INFORMATION

APPLICATION

Wall mount cabinets and mini rack for 19" components.

FEATURES

Removable side walls and glass front door
Protection rating IP20
Load capacity up to 3kg/U
Reversible front door
Pre-punched wall-fixing holes in rear wall
Mounted and packed

DIMENSIONS

Wall-mounted racks:

19"/9U, H x W x D: 475 x 570 x 400 mm
19"/9U, H x W x D: 475 x 570 x 500 mm
19"/12U, H x W x D: 600 x 570 x 400 mm
19"/12U, H x W x D: 600 x 570 x 500 mm
19"/15U, H x W x D: 750 x 570 x 400 mm
19"/15U, H x W x D: 750 x 570 x 500 mm

Mini rack:

19"/18U, H x W x D: 910 x 570 x 600 mm

DESCRIPTION

- Multi-bend basic frame, screwed together
- Glass front door with 3 mm toughened safety glass and lock, removable (lock nut hinge pins)
- Knock-out holes (top/bottom) for cable entry with pre-installed strip
- Removable side walls, perforated for passive ventilation
- 2 mounting angles 19" (482.6 mm), zinc-plated
- Cable support rail for cable ties
- Set for protective earthing conductor installation with earthing cable 1.5 mm²

DELIVERY

Mounted and packed

Article No.	Description	Height	Width	Depth (mm)	Colour
190828	Wall mounted cabinet, 19"/9U	475	570	400	light grey, RAL 7035
190829	Wall mounted cabinet, 19"/9U	475	570	500	light grey, RAL 7035
190830	Wall mounted cabinet, 19"/12U	600	570	400	light grey, RAL 7035
190831	Wall mounted cabinet, 19"/12U	600	570	500	light grey, RAL 7035
190832	Wall mounted cabinet, 19"/15U	750	570	400	light grey, RAL 7035
190833	Wall mounted cabinet, 19"/15U	750	570	500	light grey, RAL 7035
190834	Mini rack, 19"/18U	910	570	600	light grey, RAL 7035



Fig. 1: Fan set



Fig. 2: Thermostat



Fig. 3: Multiple socket



Fig. 4: Slide rail set



Fig. 5: Shelf board, retractable



Fig. 6: Shelf board, fix



Fig. 7: C profile



Fig. 8: Fastening set

PRODUCT INFORMATION

APPLICATION

The different accessories allow for customized solutions for all type SP and PX network and server racks.

Article No.	Fig.	Accessories / Description	Note
401200	–	Lever handle	on request
401201	6	Shelf set 19" x 600 mm (perforated, fix, st, 1.5 mm), RAL 7035	Load capacity 120 kg
401202	5	Shelf set 19" x 600 mm (perforated, retractable, st, 1.5 mm), RAL 7035	Load capacity 50 kg
401203	4	Slide rail set 19" x 712 mm for server rack	Load capacity 40 kg
401211	1	Fan set, 2 pcs., with protective grid and fastening set	
401212	2	Thermostat	
401213	–	Power cord for fan set, 2 m, DE/AT	
401214	–	Power cord for fan set, 2 m, CH	
401215	–	Power cord for fan set, 2 m, UK	
401220	–	Multiple socket DE/AT, 5 EU	
401221	3	Multiple socket CH, 10x type 13 vertical	other versions on request
401222	–	Multiple socket DE/AT, 9	
401230	8	Wall mounting set	for wall-mounted racks
401231	–	Fastening set with 19" screws / cage nuts	50 pcs.
401232	–	Lacquer touch-up stick, RAL 7035	on request
401233	–	Lacquer touch-up stick, RAL 9005	on request
401234	–	Measurement adhesive strip for mounting angles 1-47U	
401235	–	Baying set for network racks	on request
401236	–	19" mounting angle support	Load capacity 1000 kg
401237	7	C profile 600 for SP rack, 2 pcs.	on request
401238	7	C profile 800 for SP rack, 2 pcs.	on request
401239	7	C profile 1000 for SP rack, 2 pcs.	on request

Management panels & cable shelves, 19"/1U

in different versions



19"/1U management panel, versions made of stainless steel, with 5 support brackets



19" cable shelf with management panel



19" cable shelf with cable feedthrough panel and brush strip

PRODUCT INFORMATION

APPLICATION

19" management panels are suitable for the proper routing of copper and fibre optic cables, particularly for patch cords in racks or cabinets with 19" mounting angles and rails.

Cable shelves fulfil the same function, particularly for multiple (trunk) cables.

DESCRIPTION

19"/1U basic management panels, available in three versions:
a) stainless steel, b) black or c) grey.

These panels come without support brackets. They can be fitted with 5 support brackets in the required dimension. Please order the support brackets separately.

There are labelling strips for complete management panels with support brackets available:

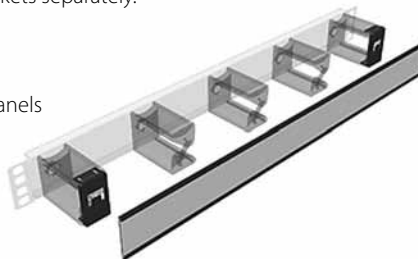

Article No.	Description	Colour / Material	PU
1411480	Support bracket 30 mm	plastic, black	1 pc.
1411481	Support bracket 75 mm	metal	1 pc.
1411482	Support bracket 110 mm	metal	1 pc.
1411604	Management panel, 19"/1U, for 5 support brackets (delivery without brackets)	RAL 7035	1 pc.
1407689	Management panel, 19"/1U, for 5 support brackets (delivery without brackets)	RAL 9005	1 pc.
418200	Management panel, 19"/1U, for 5 support brackets (delivery without brackets)	stainless steel, blank	1 pc.
401240	19" blank plate, 1U	RAL 7035	1 pc.
401241	19" blank plate, 1U	RAL 9005	1 pc.
401242	19" blank plate, 1U	stainless steel, blank	1 pc.
401243	19" blank plate, 2U	RAL 7035	1 pc.
401244	19" blank plate, 2U	RAL 9005	1 pc.
401245	19" blank plate, 2U	stainless steel, blank	1 pc.
401247	Cable feedthrough panel with brush strip, 19"/1U	RAL 7035	1 pc.
401248	Cable feedthrough panel with brush strip, 19"/1U	RAL 9005	1 pc.
401249	Cable feedthrough panel with brush strip, 19"/1U	stainless steel, blank	1 pc.
400300	19" cable shelf, depth adjustable due to slide rails (from 520 mm up to 850 mm) (only mountable with a management panel or cable feedthrough panel; rear side 19" fixation necessary)		1 pc.
470038	Labelling strip (for complete management panel with bracket type 1411480)		1 pc.
470039	Labelling strip (for complete management panel with bracket types 1411481 and 1411482)		1 pc.

Rangierpanel 1HE 0714/e



Future-proof cabling solutions for data centres

The requirements for data centre infrastructures are increasing as the rapid growth in worldwide IT usage continues. High-performance system solutions in copper, but chiefly in fibre optic technology, already constitute the backbone of high-speed data transfer in data centres.

The ever higher transmission rates not only call for high quality optical fibres, they also make increasing demands on the connecting components. Both these parameters are crucial to the efficient performance of transmission channels.

Flexibility is the core requirement for a cabling solution in today's data centre environment. New systems need to be planned, assembled and installed within a very short time. New technologies like blade systems or virtualisation, for example, mean that link performance standards are continually rising.

Datwyler's newly developed Data Centre Solution surpasses all the requirements for current cabling solutions, its high quality and excellent optical and geometric connector assembly values being of particular note here.

Benefits of the Datwyler Data Centre Solution

- Top quality guarantees top performance
- High packing densities hand in hand with good clear layout
- Fast and easy assembly (plug-and-go)
- Modifications/installations possible during ongoing operation, no need for outside companies
- Pre-assembly: no stripping, splicing or connector termination work necessary
- Slimline cable design, so no disruption to cooling air flow and no redundant lengths of cable in rack
- Scalable thanks to modular design
- Investment protection and future viability as migratable to 40/100G (MTP®)
- High spare capacity due to extremely low optical losses,
- Power budget protection thanks to bend insensitive fibres (multimode)

The most important system components

- Pre-assembled fibre optic mini trunks (high-performance)
- Pre-assembled fibre optic plug-in modules (high-performance)
- Fibre optic fanout cables (high-performance)
- Fibre optic patch cables (high-performance)
- Modularly equipped 19-inch 1U, 3U and 4U panels / subracks
- Patch management trays and cable management accessories

In server rooms and data centres these system components provide high-performance modular cabling solutions tailored to customer requirements, the outstanding features of which are clear layout, flexibility, high packing densities and good handling during operation.

Optical values of the components

Criterion Connector type	Assembly Class	Insertion Loss IL [dB]		Return Loss RL [dB]	
		mean	maximum	mean	minimum
Multi-fibre MTP Elite® 0° PC (Multimode)	Grade B	0.15	0.3	≥ 35	≥ 30
Multi-fibre MTP Elite® 8° APC (Single-mode)	Grade B	0.1	0.3	≥ 70	≥ 65
Single-fibre LCD Uniboot 0° PC (Multimode)	Grade B	0.1	0.25	≥ 40	≥ 35
Single-fibre LCD Uniboot 8° APC (Single-mode)	Grade B	0.1	0.25	≥ 75	≥ 65

MTP® and MTP Elite® are registered brands of US Conec.

Fibre optic channel configuration options

The high-performance carefully coordinated cables and components of Datwyler's Data Centre Solution can be combined as required and make it possible to implement an open infrastructure design decoupled from the user's equipment pool. The system also allows simple migration to future applications. The graphics below show some possible typical configurations.

Please note:

Only data sheets of the most important system components are covered in the following pages. You can obtain further information direct from Datwyler or on our website www.cablings.datwyler.com.

Module-to-module configuration

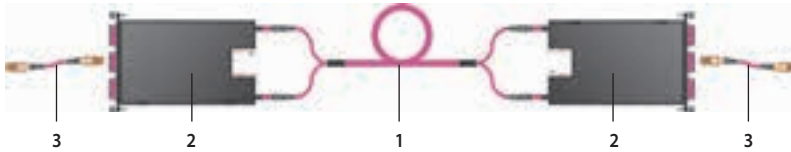

Two FO-DCS plug-in modules are inter-connected by a thin FO-DCS mini breakout cable MTP-MTP. For all known duplex applications such as 10G Ethernet or 16G Fiber Channel.

Part	Level	Description	Remarks
1	High-performance	Mini breakout cable MTP-MTP, type A or type C	12, 24, 48, 72, 96 or 144 fibres
2	High-performance	Plug-in module, 3U/7HP, 24F, 2x MTP on 12x LCD	24 fibres
3	High-performance	Patch cable LCD-LCD (Uniboot)	Polarity: A to A or A to B

These system components are available in multimode (OM3 or OM4) and single-mode (G.652.D) versions.

Module-to-module configuration (spliced)



Two FO-DCS splice plug-in modules are interconnected by a thin FO-DCS universal cable (for indoor and outdoor use). For all known duplex applications such as 10G Ethernet or 16G Fiber Channel.

Part	Level	Description	Remarks
1	High-performance	Universal cable U-DQ(ZN)BH	12, 24, 48, 72, 96 or 144 fibres
2	High-performance	Splice plug-in modules, 3U/7HP, 24F, 12x LCD	24 fibres
3	High-performance	Patch cable LCD-LCD (Uniboot)	Polarity: A to A or A to B

These system components are available in multimode (OM3 or OM4) and single-mode (G.652.D) versions.

Module-to-fanout configuration

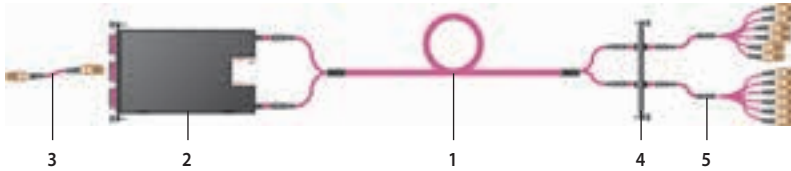

One FO-DCS plug-in module is connected to two FO-DCS fanout cables (MTP on LCD Uniboot) by a thin FO-DCS mini breakout cable MTP-MTP for a direct link between the active ports (e.g. ports of a SAN switch). For all known duplex applications such as 10G Ethernet or 16G Fiber Channel.

Part	Level	Description	Remarks
1	High-performance	Mini breakout cable MTP-MTP, type A or type C	12, 24, 48, 72, 96 or 144 fibres
2	High-performance	Plug-in module, 3U/7HP, 24F, 2x MTP on 12x LCD	24 fibres
3	High-performance	Patch cable LCD-LCD (Uniboot)	Polarity: A to A or A to B
4	High-performance	Front plate, 3U/7HP, 2x MTP adapter type A	also available with 4x or 8x MTP adapter
5	High-performance	Fanout cable, 1x MTP on 6x LCD Uniboot	Polarity: type A or type C

These system components are available in multimode (OM3 or OM4) and single-mode (G.652.D) versions.

Migration to 40/100G (parallel optics)

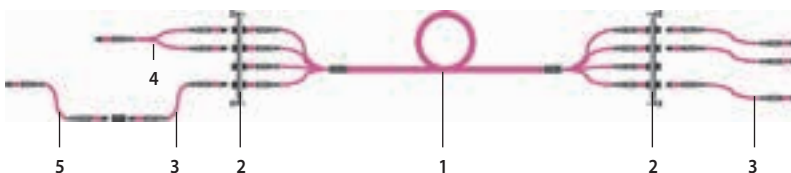

The FO-DCS plug-in modules (MTP-on-LCQ) in subracks are replaced by FO-DCS front plates with MTP adapters. The high-performance mini-breakout cables MTP can continue to be used. Datwyler supplies high-performance MTP patch cables for connection of the active IT equipment.

Part	Level	Description	Remarks
1	High-performance	Mini breakout cable MTP-MTP, type A or type C	12, 24, 48, 72, 96 or 144 fibres
2	High-performance	Front plate, 3U/7HP, 4x MTP adapter type A	also available with 2x or 8x MTP adapter
3	High-performance	Patch cable MTP-MTP	Polarity: type A, B or C, 12 fibres
4	High-performance	Y-patch cable (1x MTP 24F on 2x MTP 12F)	Polarity: type A, B or C, 24 fibres
5	High-performance	MTP jumper cable	Polarity: type A, B or C, 12 fibres

MTP® is a registered brand name of US Conec

FO-DCS modular subrack, 19"/4U
to take 12 FO-DCS plug-in modules / front plates 3U/7HP

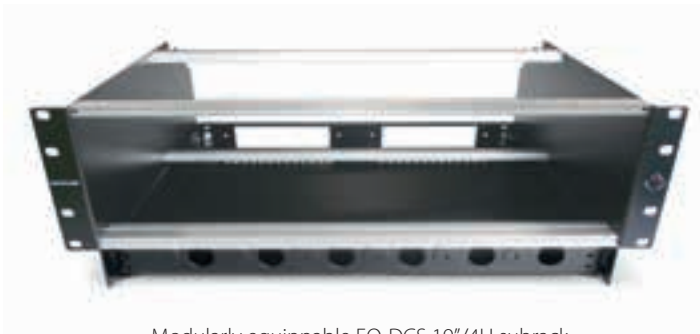

Modularly equippable FO-DCS 19"/4U subrack



Strain reliefs



Blank partial front plates

PRODUCT INFORMATION

APPLICATION

The modularly equippable 19"/4U subrack can be used for a wide variety of applications, depending on the type of plug-in module or front plate. It can be used as a modular high-density solution for up to 144 duplex ports (288 fibres) or up to 96 MTP ports (1152 fibres) in the data centre environment. It will accept up to 12 FO-DCS 3U/7HP plug-in modules or up to 12 FO-DCS 3U/7HP front plates that are used to terminate pre-assembled LCD or MTP® trunk or breakout cables or fibre optic cables which are spliced in-situ. Easy migration to all parallel optic applications, e.g. to 40/100 GbE, is possible with FO-DCS 3U/7HP MTP front plates.

DESCRIPTION

Sturdy aluminium housing with side panels and front 19"/3U mounting brackets. Pre-assembled with horizontal 84HP guide rails to take a maximum of twelve 3U/7HP FO-DCS plug-in modules or FO-DCS front plates. The extractable excess cable length tray (1U) is equipped with a base and offers 2 big slots on one side and pre-cut holes on the other side. It can be inserted to the subrack on the fourth rack unit from the rear in two ways, so that optionally the slots or holes can be used as cable entry openings. The slightly recessed arrangement of the excess cable length tray allows a 19"/1U management panel with support brackets or a patch management tray with guide elements to be fitted at the front.

SCOPE OF DELIVERY

19"/4U subrack with 19" mounting brackets on 3U (without plug-in modules / front plates)
84HP guide rails for 12 3U/7HP FO-DCS inserts
1U excess cable length tray, integrated, insertable from rear
19" mounting material

Cable support rails and more accessories available.
May be combined with various blanking panels and management panels from the Datwyler range.

TECHNICAL DATA

Material: Aluminium
Colour: Aluminium, anodised or black
Dimensions: 19"/4U, W x H x D: 482.6 x 177.6 x 295 mm
Acceptance capacity: 84HP, 12 3U/7HP FO-DCS inserts

Article No.	Description	Material/Colour	PU
470540	FO-DCS modular subrack, 19"/3U, 84HP (without excess length tray)	Alu, anodised	1 pc.
470542	FO-DCS modular subrack, 19"/4U, 84HP	Alu, anodised	1 pc.
470642	FO-DCS modular subrack, 19"/4U, 84HP	Alu, black	1 pc.
470648	Strain relief for FO-DCS modular subrack 4U (depth: 80 mm)		1 pc.
470549	Strain relief for FO-DCS modular subrack 4U (depth: 48 mm)		1 pc.
470649	Strain relief for FO-DCS modular subrack 4U, with black brush strip (depth: 48 mm)		1 pc.
470555	FO-DCS blank partial front plate 3U/7HP	Alu, anodised	1 pc.
571595	FO-DCS blank partial front plate 3U/7HP	PC, black	1 pc.

MTP® is a registered brand of US Conec.

FO-DCS modular panel, 19"/1U

to take 3 FO-DCS plug-in modules / front plates 3U/7HP



Modularly equippable FO-DCS 19"/1U panel



Blank partial front plate

PRODUCT INFORMATION

APPLICATION

The modularly equippable 19"/1U panel can be used for a wide variety of applications, depending on the type of plug-in module. It can be used as a modular high-density solution for up to 36 duplex ports (72 fibres) or up to 24 MTP ports (288 fibres) in the data centre environment. It will accept up to 3 FO-DCS 3U/7HP plug-in modules or up to 3 FO-DCS 3U/7HP front plates that are used to terminate pre-assembled LCD or MTP® trunk or breakout cables or fibre optic cables which are spliced in-situ. Easy migration to all parallel optic applications, e.g. to 40/100 GbE, is possible with FO-DCS 3U/7HP MTP front plates.

DESCRIPTION

Sturdy aluminium housing with base, side panels and front 19"/1U mounting brackets. Pre-assembled to take a maximum of three 3U/7HP FO-DCS plug-in modules or front plates. 3 cable support rails for the back side cable entries are enclosed separately.

SCOPE OF DELIVERY

19"/1U panel with 19" mounting brackets (without plug-in modules / front plates)
3 cable support rails, enclosed separately
19" mounting material

Can be combined with various blanking panels and management panels from the Datwyler range.

TECHNICAL DATA

Material: Aluminium
Colour: Aluminium, anodised or black
Dimensions: 19"/1U, W x H x D: 482.6 x 44.4 x 315 mm
Acceptance capacity: 3 3U/7HP FO-DCS inserts

Article No.	Description	Material/Colour	PU
470543	FO-DCS modular panel, 19"/1U (delivery without plug-in modules/front panels)	Alu, anodised	1 pc.
470643	FO-DCS modular panel, 19"/1U (delivery without plug-in modules/front panels)	Alu, black	1 pc.
470555	FO-DCS blank partial front plate 3U/7HP	Alu, anodised	1 pc.
571595	FO-DCS blank partial front plate 3U/7HP	PC, black	1 pc.

MTP® is a registered brand of US Conec.



19"/1U FO-DCS management panel with 6 cable routing elements (right-side routing) and front plate

PRODUCT INFORMATION

APPLICATION	The management panel is used for the proper routing of fibre optic patch cables in all 19" IT racks and cabinets.								
DESCRIPTION	<p>The 19"/1U management panel is available in three versions:</p> <ul style="list-style-type: none"> - all six routing elements with right-side routing - all six routing elements with left-side routing - three routing elements with left-side and three with right-side routing <p>The patch cables can be fixed by hook-and-loop tape on the left and/or right side. An appropriate labelling strip for the front plate is available as an option.</p>								
SCOPE OF DELIVERY	19"/1U FO-DCS management panel with 6 cable routing elements, detachable front plate								
TECHNICAL DATA	<table border="0" style="width: 100%;"> <tr> <td style="width: 30%;">Material:</td> <td>Aluminium</td> </tr> <tr> <td>Colour:</td> <td>Aluminium, anodised or black</td> </tr> <tr> <td>Dimensions:</td> <td>19"/1U</td> </tr> <tr> <td>Equipment:</td> <td>6 routing elements and detachable front plate</td> </tr> </table>	Material:	Aluminium	Colour:	Aluminium, anodised or black	Dimensions:	19"/1U	Equipment:	6 routing elements and detachable front plate
Material:	Aluminium								
Colour:	Aluminium, anodised or black								
Dimensions:	19"/1U								
Equipment:	6 routing elements and detachable front plate								

Article no.	Description	Material/Colour	PU
470544	FO-DCS management panel, 19"/1U, left-side routing	Alu, anodised	1 pc.
470545	FO-DCS management panel, 19"/1U, right-side routing	Alu, anodised	1 pc.
470546	FO-DCS management panel, 19"/1U, left/right-side routing	Alu, anodised	1 pc.
470644	FO-DCS management panel, 19"/1U, left-side routing	Alu, black	1 pc.
470645	FO-DCS management panel, 19"/1U, right-side routing	Alu, black	1 pc.
470646	FO-DCS management panel, 19"/1U, left/right-side routing	Alu, black	1 pc.
470554	Labelling strip for FO-DCS management panel, 420 x 12 mm		1 pc.
4000140	Hook-and-loop tape, 19 mm (1 pc. = 10 m roll)		1 pc.

FO-DCS compact breakout panels, 19"/1U

with 12 or 24 LC Quad adapters

for OM3, OM4 and OS2



Compact 19"/1U breakout panel,
version with 12 LCQ ports, OM3 turquoise



View from rear

PRODUCT INFORMATION

APPLICATION

Compact 19"/1U breakout panels with 12 or 24 LC Quad adapters are a cost-optimised high-density solution for all high-performance applications with duplex signals, particularly in the data centre environment. They are used to accept pre-assembled LCD trunk cables or LCD breakout cables.

DESCRIPTION

Sturdy aluminium housing with base, side panels and front 19"/1U mounting. Pre-assembled with 12 or 24 LC Quad adapters. At the front the panels provide 24 duplex ports (48 fibres) or 48 duplex ports (96 fibres).

SCOPE OF DELIVERY

19"/1U compact panel, with 19" mounting brackets
Aluminium front panel, fitted with 12 or 24 LC Quad adapters
19" mounting material

Cable support rails available as accessories.
Can be combined with various blanking panels and management panels from the Datwyler range.

TECHNICAL DATA

Material: Aluminium, anodised
Dimensions: 19"/1U, W x H x D: 482.6 x 44.4 x 320 mm
Acceptance capacity: 24 or 48 duplex ports (48 or 96 fibres)

Article No.	Description	Colour	PU
470618	FO-DCS compact breakout panel, 19"/1U, 12x LCQ, OM3 turquoise	Alu, anodised	1 pc.
470619	FO-DCS compact breakout panel, 19"/1U, 12x LCQ, OM4 heather violet	Alu, anodised	1 pc.
470620	FO-DCS compact breakout panel, 19"/1U, 12x LCQ, OS2 blue	Alu, anodised	1 pc.
470621	FO-DCS compact breakout panel, 19"/1U, 12x LCQ, OS2 green	Alu, anodised	1 pc.
470622	FO-DCS compact breakout panel, 19"/1U, 24x LCQ, OM3 turquoise	Alu, anodised	1 pc.
470623	FO-DCS compact breakout panel, 19"/1U, 24x LCQ, OM4 heather violet	Alu, anodised	1 pc.
470624	FO-DCS compact breakout panel, 19"/1U, 24x LCQ, OS2 blue	Alu, anodised	1 pc.
470625	FO-DCS compact breakout panel, 19"/1U, 24x LCQ, OS2 green	Alu, anodised	1 pc.

FO-DCS compact breakout panels, 19"/1U

with 12 or 24 LC Quad adapters
for OM3, OM4 and OS2

PRODUCT INFORMATION

FEATURES

Type	Breakout MM LCD	Breakout MM LCD	Breakout SM LCD	Breakout SM LCD
Acceptance capacity	48 fibres / 96 fibres	48 fibres / 96 fibres	48 fibres / 96 fibres	48 fibres / 96 fibres
Connector type, front	LC Quad	LC Quad	LC Quad	LC Quad
Number	12 / 24	12 / 24	12 / 24	12 / 24
Sleeve	Zirconia (ZrO ₂)	Zirconia (ZrO ₂)	Zirconia (ZrO ₂)	Zirconia (ZrO ₂)
Housing colour	turquoise	heather violet	blue	green
Housing material	polymer	polymer	polymer	polymer
Dust cap (duplex)	transparent	transparent	transparent	transparent

CONFORMANCE LC IEC 61754-20

REMARKS Laser protection: Optional LCD laser protection clips (metal) can be obtained and retrofitted

As a high-performance patch cable we recommend the FO-DCS LCD Uniboot patch cable

FO-DCS compact panels, 19"/1U

with MTP-LCD pre-assembly

for OM3, OM4 and OS2



Compact, pre-assembled 19"/1U panel, version with 8 MTP couplers (rear) and 48 OM3 LCD ports turquoise (front)



View from rear with cover

PRODUCT INFORMATION

APPLICATION

These compact, pre-assembled FO-DCS panels are a cost-optimised high-density solution for all high-performance applications with duplex signals, particularly in the data centre environment. They are used to accept pre-assembled MTP® trunk cables or MTP breakout cables.

DESCRIPTION

Sturdy aluminium housing with base, side panels, cover and front 19"/1U mounting. Pre-assembled with 4 or 8 MTP couplers (rear side), 4 or 8 MTP-on-LC (high performance) module fanouts and 12 or 24 LC quad adapters (front side). At the front side the panels therefore provide 24 or 48 duplex ports (48 or 96 fibres). Top-quality assembly ensures optimum values for optical performance (IL/RL).

SCOPE OF DELIVERY

19"/1U compact panel with 19" mounting brackets
 Aluminium front panel, fitted with 12 or 24 LC Quad adapters
 19" mounting material
 Aluminium rear panel, fitted with 4 or 8 MTP adapters
 Aluminium cover, fixed with screws
 4 or 8 module fanouts (high performance): per 12 fibres 1x MTP Elite® (female) on 12x LC
 Supplied inclusive of test certificates for all fanouts

Cable support rails available as accessories
 Can be combined with various blanking panels and management panels from the Datwyler range.

TECHNICAL DATA

Material/Colour: Aluminium, anodised
 Dimensions: 19"/1U, W x H x D: 482.6 x 44.4 x 320 mm
 Acceptance capacity: 24 or 48 duplex ports (48 or 96 fibres)
 Equipment: Fully equipped (without cable feed accessories)

Article No.	Description	Material/Colour	PU
470610	FO-DCS compact panel, 19"/1U, 4x MTP on 24x LCD, OS2 blue	Alu, anodised	1 pc.
470611	FO-DCS compact panel, 19"/1U, 4x MTP on 24x LCD-APC, OS2 green	Alu, anodised	1 pc.
470612	FO-DCS compact panel, 19"/1U, 4x MTP on 24x LCD, OM3 turquoise	Alu, anodised	1 pc.
470613	FO-DCS compact panel, 19"/1U, 4x MTP on 24x LCD, OM4 heather violet	Alu, anodised	1 pc.
470614	FO-DCS compact panel, 19"/1U, 8x MTP on 48x LCD, OS2 blue	Alu, anodised	1 pc.
470615	FO-DCS compact panel, 19"/1U, 8x MTP on 48x LCD-APC, OS2 green	Alu, anodised	1 pc.
470616	FO-DCS compact panel, 19"/1U, 8x MTP on 48x LCD, OM3 turquoise	Alu, anodised	1 pc.
470617	FO-DCS compact panel, 19"/1U, 8x MTP on 48x LCD, OM4 heather violet	Alu, anodised	1 pc.

MTP® and MTP Elite® are registered brands of US Conec.

PRODUCT INFORMATION

FEATURES

	TYPE	MTP – LCD OM3	MTP – LCD OM4	MTP – LCD-PC OS2 (G.652.D)	MTP – LCD-APC OS2 (G.652.D)
	Acceptance capacity	48 fibres 96 fibres	48 fibres 96 fibres	48 fibres 96 fibres	48 fibres 96 fibres
Rear (side A)	Connectors	4x / 8x MTP® unpinned	4x / 8x MTP unpinned	4x / 8x MTP unpinned	4x / 8x MTP unpinned
	Ferrule type, polishing	Elite® PC 0°	Elite PC 0°	Elite APC 8°	Elite APC 8°
	Insertion Loss IL (mean)	≤ 0.15 dB ¹	≤ 0.15 dB ¹	≤ 0.1 dB	≤ 0.1 dB
	Insertion Loss IL (maximum)	≤ 0.30 dB ¹	≤ 0.30 dB ¹	≤ 0.30 dB	≤ 0.30 dB
	Return Loss RL (mean)	≥ 35 dB	≥ 35 dB	≥ 70 dB	≥ 70 dB
	Return Loss RL (minimum)	≥ 30 dB	≥ 30 dB	≥ 65 dB	≥ 65 dB
	Connector type	4x / 8x type A	4x / 8x type A	4x / 8x type A	4x / 8x type A
	Housing colour (connector)	black	black	black	black
Front (side B)	Connector, polishing	48x / 96x LC-PC 0°	48x / 96x LC-PC 0°	48x / 96x LC-PC 0°	48x / 96x LC-APC 8°
	Ferrules	zirconia (ZrO ₂)	zirconia (ZrO ₂)	zirconia (ZrO ₂)	zirconia (ZrO ₂)
	Insertion Loss IL (mean)	≤ 0.1 dB ¹	≤ 0.1 dB ¹	≤ 0.1 dB	≤ 0.1 dB
	Insertion Loss IL (maximum)	≤ 0.25 dB ¹	≤ 0.25 dB ¹	≤ 0.25 dB	≤ 0.25 dB
	Return Loss RL (mean)	≥ 40 dB	≥ 40 dB	≥ 40 dB	≥ 75 dB
	Return Loss RL (minimum)	≥ 35 dB	≥ 35 dB	≥ 35 dB	≥ 65 dB
	Connector type	12x / 24x LC Quad	12x / 24x LC Quad	12x / 24x LC Quad	12x / 24x LC Quad
	Sleeve	zirconia (ZrO ₂)	zirconia (ZrO ₂)	zirconia (ZrO ₂)	zirconia (ZrO ₂)
	Housing colour (connector)	turquoise	heather violet	blue	geen
	Housing material (connector)	polymer	polymer	polymer	polymer
	Dust caps (duplex)	transparent	transparent	transparent	transparent
Module fanouts (per 12 fibres)	4 / 8 pieces	4 / 8 pieces	4 / 8 pieces	4 / 8 pieces	
Fibre type	MM 50/125 OM3	MM 50/125 OM4	SM 9/125 G.652.D OS2	SM 9/125 G.652.D OS2	
Fibre colour code	IEC 60304	IEC 60304	IEC 60304	IEC 60304	

¹ Insertion Loss (IL) is determined by the latest measurement methods under EFL multimode excitation conditions (EFL = Encircled Flux Launch) at 850 nm in accordance with IEC 61280-4-1.

CONFORMANCE

MTP	IEC 61754-7, IEC 61755-3-31, IEC 611755-3-32
LC	IEC 61754-20

REMARKS

Laser protection:	Optional LCD laser protection clips (metal), can be obtained and retrofitted
Polarity methods:	Fiber light propagation conforms to TIA-568-C.3

As a high-performance patch cable we recommend the FO-DCS LCD Uniboot patch cable

MTP® and MTP Elite® are registered brands of US Conec.

FO-DCS MTP plug-in modules, 12F, 3U/7HP

for FO-DCS modular subrack / modular panel

for OM3, OM4, OS2



High-performance
FO-DCS MTP plug-in modules,
12F, 3U/7HP

PRODUCT INFORMATION

APPLICATION

FO-DCS MTP® plug-in modules are suitable for all high-performance applications with duplex signals, particularly in the data centre environment. They find modular application in FO-DCS modular panels (19"/1U) or in FO-DCS subracks (19"/3U, 19"/4U).

They are used to accept pre-assembled MTP trunk cables.

Packing densities of up to 144 fibres on 3U are achieved with these plug-in modules.

They are assembled to a very high quality and guarantee optimum values for optical performance (IL/RL).

DESCRIPTION

Polycarbonate (PC) housing with press-fit side panels (sealed) and polycarbonate (black) or aluminium front panel (1U/7HP).

At the rear these FO-DCS plug-in modules have one MTP coupler which is routed to the front couplers (6x LC duplex) by way of an internal fanout and integrated fibre management. The black PC front panels provide labelling strips on both sides of the LCD ports for customer-specific printing.

Fixed with two knurled screws (captive).

SCOPE OF DELIVERY

Housing with front panel, equipped with 6 LC duplex adapters (ceramic sleeves).

Rear fitted with 1 MTP adapter (Type A).

1 module fanout (High P): 12 fibres, 1x MTP Elite® (female) on 12x LC (ceramic ferrules).

Delivery inclusive of test reports on fanout.

TECHNICAL DATA

Material:	Polycarbonate (PC)
Front panel:	Polycarbonate or aluminium
Front panel colour:	Black (PC) or aluminium, anodised
Dimensions:	3U/7HP, W x H x D: 35 x 129 x 180 mm (without couplers)
Acceptance capacity:	6 duplex ports (12 fibres)
Equipment:	fully equipped (plug-and-go)

Article No.	Description	Front panel	PU
571506	FO-DCS 3U/7HP plug-in module, 1x MTP on 6x LCD, OM3	PC, black	1 pc.
571507	FO-DCS 3U/7HP plug-in module, 1x MTP on 6x LCD, OM4	PC, black	1 pc.
571508	FO-DCS 3U/7HP plug-in module, 1x MTP on 6x LCD/PC, OS2 (G.652.D)	PC, black	1 pc.
571509	FO-DCS 3U/7HP plug-in module, 1x MTP on 6x LCD/APC, OS2 (G.652.D)	PC, black	1 pc.
571606	FO-DCS 3U/7HP plug-in module, 1x MTP on 6x LCD, OM3	Alu, anodised	1 pc.
571607	FO-DCS 3U/7HP plug-in module, 1x MTP on 6x LCD, OM4	Alu, anodised	1 pc.
571608	FO-DCS 3U/7HP plug-in module, 1x MTP on 6x LCD/PC, OS2 (G.652.D)	Alu, anodised	1 pc.
571609	FO-DCS 3U/7HP plug-in module, 1x MTP on 6x LCD/APC, OS2 (G.652.D)	Alu, anodised	1 pc.
571599	Labelling sheet A4, perforated (blank)	white	10 pcs.

MTP® and MTP Elite® are registered brands of US Conec.

FO-DCS MTP plug-in modules, 12F, 3U/7HP
for FO-DCS modular subrack / modular panel
for OM3, OM4, OS2

PRODUCT INFORMATION

FEATURES

	TYPE	OM3	OM4	OS2 LC-PC	OS2 LC-APC
	Acceptance capacity	12 fibres	12 fibres	12 fibres	12 fibres
	Connector	1x MTP® unpinned	1x MTP unpinned	1x MTP unpinned	1x MTP unpinned
	Ferrule type, polishing	Elite® PC 0°	Elite PC 0°	Elite APC 8°	Elite APC 8°
Rear (side A)	Insertion Loss IL (mean)	≤ 0.15 dB ¹	≤ 0.15 dB ¹	≤ 0.1 dB	≤ 0.1 dB
	Insertion Loss IL (maximum)	≤ 0.30 dB ¹	≤ 0.30 dB ¹	≤ 0.30 dB	≤ 0.30 dB
	Return Loss RL (mean)	≥ 35 dB	≥ 35 dB	≥ 70 dB	≥ 70 dB
	Return Loss RL (minimum)	≥ 30 dB	≥ 30 dB	≥ 65 dB	≥ 65 dB
	Connector type	1x type A	1x type A	1x type A	1x type A
	Housing colour (connector)	black	black	black	black
Front (side B)	Connector, polishing	12x LC PC 0°	12x LC PC 0°	12x LC PC 0°	12x LC APC 8°
	Ferrules	zirconia (ZrO ₂)	zirconia (ZrO ₂)	zirconia (ZrO ₂)	zirconia (ZrO ₂)
	Insertion Loss IL (mean)	≤ 0.1 dB ¹	≤ 0.1 dB ¹	≤ 0.1 dB	≤ 0.1 dB
	Insertion Loss IL (maximum)	≤ 0.25 dB ¹	≤ 0.25 dB ¹	≤ 0.25 dB	≤ 0.25 dB
	Return Loss RL (mean)	≥ 40 dB	≥ 40 dB	≥ 40 dB	≥ 75 dB
	Return Loss RL (minimum)	≥ 35 dB	≥ 35 dB	≥ 35 dB	≥ 65 dB
	Connector type	6x LC Duplex	6x LC Duplex	6x LC Duplex	6x LC Duplex
	Sleeve	zirconia (ZrO ₂)	zirconia (ZrO ₂)	zirconia (ZrO ₂)	zirconia (ZrO ₂)
	Housing colour (connector)	turquoise	heather violet	blue	green
	Housing material (connector)	polymer	polymer	polymer	polymer
	Dust caps (duplex)	transparent	transparent	transparent	transparent
	Module fanout (12 fibres)	1 piece	1 piece	1 piece	1 piece
Fibre type	MM 50/125 OM3	MM 50/125 OM4	SM 9/125 G.652.D OS2	SM 9/125 G.652.D OS2	
Fibre colour code	IEC 60304	IEC 60304	IEC 60304	IEC 60304	

¹ Insertion Loss (IL) is determined by the latest measurement methods under EFL multimode excitation conditions (EFL = Encircled Flux Launch) at 850 nm in accordance with IEC 61280-4-1.

CONFORMANCE

MTP IEC 61754-7, IEC 61755-3-31, IEC 611755-3-32
LC IEC 61754-20

REMARKS

Laser protection: Optional LCD laser protection clips (metal) can be obtained and retrofitted
Polarity methods: Fibre light propagation conforms to TIA-568-C.3

As a high-performance patch cable we recommend the FO-DCS LCD Uniboot patch cable.

MTP® and MTP Elite® are registered brands of US Conec.

FO-DCS MTP plug-in modules, 12F, 3U/7HP

for FO-DCS modular subracks / modular panel

for OS2 (G.652.D)



High-performance
FO-DCS MTP plug-in modules,
12F, 3U/7HP, for OS2 (G.652.D)

PRODUCT INFORMATION

APPLICATION

FO-DCS MTP® plug-in modules are suitable for all high-performance applications with duplex signals, particularly in the data centre environment. They find modular application in FO-DCS modular panels (19"/1U) or in FO-DCS modular subracks (19"/3U, 19"/4U). They are used to accept pre-assembled MTP trunk cables. Packing densities of up to 144 fibres on 3U are achieved with these plug-in modules. They are assembled to a very high quality and guarantee optimum values for optical performance (IL/RL).

DESCRIPTION

Polycarbonate (PC) housing with press-fit side panels (sealed) and polycarbonate (black) or aluminium front panel (7HP/1U). At the rear these FO-DCS plug-in modules have one MTP coupler which is routed to the front couplers (6x LSH-C) by way of an internal fanout and integrated fibre management. The black PC front panels provide labelling strips on both sides of the LCD ports for customer-specific printing. Fixed with two knurled screws (captive).

SCOPE OF DELIVERY

Housing with front panel, equipped with 6 LSH-C adapters (ceramic sleeves). Rear fitted with 1 MTP adapter (Type A). 1 module fanout (High P): 12 fibres, 1x MTP Elite® (female) on 12x LSH (ceramic ferrules). Delivery inclusive of test reports on fanout.

TECHNICAL DATA

Material:	Polycarbonate (PC)
Front panel:	Polycarbonate or aluminium
Front panel colour:	Black (PC) or aluminium, anodised
Dimensions:	3U/7HP, W x H x D: 35 x 129 x 180 mm (without couplers)
Acceptance capacity:	6 LSH-C ports (12 fibres)
Equipment:	fully equipped (plug-and-go)

Article No.	Description	Front panel	PU
571505	FO-DCS 3U/7HP plug-in module, 1x MTP on 6x LSH-C/APC, OS2 (G.652.D)	PC, black	1 pc.
571605	FO-DCS 3U/7HP plug-in module, 1x MTP on 6x LSH-C/APC, OS2 (G.652.D)	Alu, anodised	1 pc.
571599	Labelling sheet A4, perforated (blank)	white	10 pcs.

MTP® and MTP Elite® are registered brands of US Conec.

PRODUCT INFORMATION

FEATURES

	TYPE	OS2 LSH-C-APC	
	Acceptance capacity	12 fibres	
	Connector	1x MTP® unpinned	
	Ferrule type, polishing	Elite® APC 8°	
Rear (side A)	Insertion Loss IL (mean)	≤ 0.1 dB	
	Insertion Loss IL (maximum)	≤ 0.30 dB	
	Return Loss RL (mean)	≥ 70 dB	
	Return Loss RL (minimum)	≥ 65 dB	
	Connector type	1x type A	
	Housing colour (connector)	black	
		Connector, polishing	12x LSH APC 8°
	Ferrules	zirconia (ZrO ₂)	
	Insertion Loss IL (mean)	0.1 dB	
Front (side B)	Insertion Loss IL (maximum)	≤ 0.25 dB	
	Return Loss RL (mean)	75 dB	
	Return Loss RL (minimum)	≥ 65 dB	
	Connector type	6x LSH-C	
	Sleeve	zirconia (ZrO ₂)	
	Housing colour (connector)	green	
	Housing material (connector)	polymer	
	Dust caps	black	
		Module fanout (12 fibres)	1 piece
		Fibre type	SM 9/125 G.652.D OS2
	Fibre colour code	IEC 60304	

CONFORMANCE MTP IEC 61754-7, IEC 61755-3-31, IEC 611755-3-32
LC IEC 61754-20

REMARKS Laser protection: integrated
Polarity methods: Fibre light propagation conforms to TIA-568-C.3

As patch cable we recommend the FO-DCS patch cable LSH-C (High Performance).

MTP® and MTP Elite® are registered brands of US Conec.

FO-DCS MTP plug-in modules, 24F, 3U/7HP

for FO-DCS modular subracks / modular panel

for OM3, OM4, OS2



High-performance
FO-DCS MTP plug-in modules,
24F, 3U/7HP

PRODUCT INFORMATION

APPLICATION

FO-DCS MTP® plug-in modules are suitable for all high-performance applications with duplex signals, particularly in the data centre environment. They find modular application in FO-DCS modular panels (19"/1U) or in FO-DCS subracks (19"/3U, 19"/4U). They are used to accept pre-assembled MTP trunk cables. Packing densities of up to 288 fibres on 3U are achieved with these plug-in modules. They are assembled to a very high quality and guarantee optimum values for optical performance (IL/RL).

DESCRIPTION

Polycarbonate (PC) housing with press-fit side panels (sealed) and polycarbonate (black) or aluminium front panel (1U/7HP). At the rear these FO-DCS plug-in modules have two MTP couplers which are routed to the front couplers (6x LC Quad) by way of internal fanouts and integrated fibre management. The black PC front panel provides labelling strips on both sides of the LC Quads for customer-specific printing. Fixed with two knurled screws (captive).

SCOPE OF DELIVERY

Housing with front panel, equipped with 6 LC Quad adapters (ceramic sleeves). Rear fitted with 2 MTP adapters (Type A). 2 module fanouts (High P): per 12 fibres, 1x MTP Elite® (female) on 12x LC (ceramic ferrules). Delivery inclusive of test reports on all fanouts.

TECHNICAL DATA

Material:	Polycarbonate (PC)
Front panel:	Polycarbonate or aluminium
Front panel colour:	Black (PC) or aluminium, anodised
Dimensions:	3U/7HP, W x H x D: 35 x 129 x 180 mm (without couplers)
Acceptance capacity:	12 duplex ports (24 fibres)
Equipment:	fully equipped (plug-and-go)

Article No.	Description	Front panel	PU
571500	FO-DCS 3U/7HP plug-in module, 2x MTP on 6x LCQ, OM3	PC, black	1 pc.
571501	FO-DCS 3U/7HP plug-in module, 2x MTP on 6x LCQ, OM4	PC, black	1 pc.
571502	FO-DCS 3U/7HP plug-in module, 2x MTP on 6x LCQ/PC, OS2 (G.652.D)	PC, black	1 pc.
571503	FO-DCS 3U/7HP plug-in module 2x MTP on 6x LCQ/APC, OS2 (G.652.D)	PC, black	1 pc.
571600	FO-DCS 3U/7HP plug-in module 2x MTP on 6x LCQ, OM3	Alu, anodised	1 pc.
571601	FO-DCS 3U/7HP plug-in module, 2x MTP on 6x LCQ, OM4	Alu, anodised	1 pc.
571602	FO-DCS 3U/7HP plug-in module, 2x MTP on 6x LCQ/PC, OS2 (G.652.D)	Alu, anodised	1 pc.
571603	FO-DCS 3U/7HP plug-in module, 2x MTP on 6x LCQ/APC, OS2 (G.652.D)	Alu, anodised	1 pc.
571599	Labelling sheet A4, perforated (blank)	white	10 pcs.

MTP® and MTP Elite® are registered brands of US Conec.

PRODUCT INFORMATION

FEATURES

	TYPE	OM3	OM4	OS2 LC-PC	OS2 LC-APC
	Acceptance capacity	24 fibres	24 fibres	24 fibres	24 fibres
	Connectors	2x MTP® unpinned	2x MTP unpinned	2x MTP unpinned	2x MTP unpinned
	Ferrule type, polishing	Elite® PC 0°	Elite PC 0°	Elite APC 8°	Elite APC 8°
Rear (side A)	Insertion Loss IL (mean)	≤ 0.15 dB ¹	≤ 0.15 dB ¹	≤ 0.1 dB	≤ 0.1 dB
	Insertion Loss IL (maximum)	≤ 0.30 dB ¹	≤ 0.30 dB ¹	≤ 0.30 dB	≤ 0.30 dB
	Return Loss RL (mean)	≥ 35 dB	≥ 35 dB	≥ 70 dB	≥ 70 dB
	Return Loss RL (minimum)	≥ 30 dB	≥ 30 dB	≥ 65 dB	≥ 65 dB
	Connector type	2x type A	2x type A	2x type A	2x type A
	Housing colour (connector)	black	black	black	black
	Connector, polishing	24x LC PC 0°	24x LC PC 0°	24x LC PC 0°	24x LC APC 8°
	Ferrules	zirconia (ZrO ₂)	zirconia (ZrO ₂)	zirconia (ZrO ₂)	zirconia (ZrO ₂)
Front (side B)	Insertion Loss IL (mean)	≤ 0.1 dB ¹	≤ 0.1 dB ¹	≤ 0.1 dB	≤ 0.1 dB
	Insertion Loss IL (maximum)	≤ 0.25 dB ¹	≤ 0.25 dB ¹	≤ 0.25 dB	≤ 0.25 dB
	Return Loss RL (mean)	≥ 40 dB	≥ 40 dB	≥ 40 dB	≥ 75 dB
	Return Loss RL (minimum)	≥ 35 dB	≥ 35 dB	≥ 35 dB	≥ 65 dB
	Connector type	6x LC Quad	6x LC Quad	6x LC Quad	6x LC Quad
	Sleeve	zirconia (ZrO ₂)	zirconia (ZrO ₂)	zirconia (ZrO ₂)	zirconia (ZrO ₂)
	Housing colour (connector)	turquoise	heather violet	blue	green
	Housing material (connector)	polymer	polymer	polymer	polymer
	Dust caps (duplex)	transparent	transparent	transparent	transparent
	Module fanouts (per 12 fibres)	2 pieces	2 pieces	2 pieces	2 pieces
Fibre type	MM 50/125 OM3	MM 50/125 OM4	SM 9/125 G.652.D OS2	SM 9/125 G.652.D OS2	
Fibre colour code	IEC 60304	IEC 60304	IEC 60304	IEC 60304	

¹ Insertion Loss (IL) is determined by the latest measurement methods under EFL multimode excitation conditions (EFL = Encircled Flux Launch) at 850 nm in accordance with IEC 61280-4-1.

CONFORMANCE

MTP IEC 61754-7, IEC 61755-3-31, IEC 611755-3-32
LC IEC 61754-20

REMARKS

Laser protection: Optional LCD laser protection clips (metal) can be obtained and retrofitted
Polarity methods: Fibre light propagation conforms to TIA-568-C.3

As a high-performance patch cable we recommend the FO-DCS LCD Uniboot patch cable.

MTP® and MTP Elite® are registered brands of US Conec.

FO-DCS splice plug-in modules, 12F, 3U/7HP

for FO-DCS modular subracks / modular panel

with 1x 12 pigtails OM3, OM4, OS2 and 6 LCD adapters



High-performance
FO-DCS splice plug-in modules,
12F, 3U/7HP

PRODUCT INFORMATION

APPLICATION

FO-DCS splice plug-in modules are suitable for all high-performance applications with duplex signals, particularly in the data centre environment. They find modular application in FO-DCS modular panels (19"/1U) or in FO-DCS subracks (19"/3U, 19"/4U). They are used to accept fibre optic cables which are spliced in-situ. Packing densities of up to 144 fibres on 3U are achieved with these plug-in modules. They are assembled to a very high quality and guarantee optimum values for optical performance (IL/RL).

DESCRIPTION

Polycarbonate (PC) housing with press-fit side panels and polycarbonate (black) or aluminium front panel (3U/7HP). Equipped with 1 splice cassette for 12 fibres. Splice cassette has splice reserve on both sides (cable / pigtail), splice comb and strain relief. Black PC front panels provide labelling strips on both sides of the LCD ports for customer-specific printing. Fixed with two knurled screws (captive). There is a separate distribution box available for the partition of multi-fibre loose tube cables or for storing the excess tube lengths.

SCOPE OF DELIVERY

Housing with front panel, equipped with 6 LC Duplex adapters (ceramic sleeves). Rear fitted with one M12 cable entry.
1 splice cassette with cover and splice comb for 12 fibres.
1 pigtail set (1.3 m), 12x LC (ceramic ferrules).

TECHNICAL DATA

Material:	Polycarbonate (PC)
Front panel:	Polycarbonate or aluminium
Front panel colour:	Black (PC) or aluminium, anodised
Dimensions:	3U/7HP, W x H x D: 35 x 129 x 180 mm (without couplers)
Acceptance capacity:	6 LC Duplex ports (12 fibres)
Equipment:	fully equipped

Article No.	Description	Front panel	PU
571536	FO-DCS 3U/7HP splice plug-in module, 6x LCD, OM3	PC, black	1 pc.
571537	FO-DCS 3U/7HP splice plug-in module, 6x LCD, OM4	PC, black	1 pc.
571538	FO-DCS 3U/7HP splice plug-in module, 6x LCD/PC, OS2 (G.652.D)	PC, black	1 pc.
571539	FO-DCS 3U/7HP splice plug-in module, 6x LCD/APC, OS2 (G.652.D)	PC, black	1 pc.
571636	FO-DCS 3U/7HP splice plug-in module, 6x LCD, OM3	Alu, anodised	1 pc.
571637	FO-DCS 3U/7HP splice plug-in module, 6x LCD, OM4	Alu, anodised	1 pc.
571638	FO-DCS 3U/7HP splice plug-in module, 6x LCD/PC, OS2 (G.652.D)	Alu, anodised	1 pc.
571639	FO-DCS 3U/7HP splice plug-in module, 6x LCD/APC, OS2 (G.652.D)	Alu, anodised	1 pc.
571599	Labelling sheet A4, perforated (blank)	white	10 pcs.

FO-DCS splice plug-in modules, 12F, 3U/7HP

for FO-DCS modular subracks / modular panel
with 1x 12 pigtailed OM3, OM4, OS2 and 6 LCD adapters

PRODUCT INFORMATION

FEATURES

TYPE	OM3	OM4	OS2 LC-PC	OS2 LC-APC
Acceptance capacity	12 fibres	12 fibres	12 fibres	12 fibres
Connectors (front side)	12x LC PC 0°	12x LC PC 0°	12x LC PC 0°	12x LC APC 8°
Ferrules	zirconia (ZrO ₂)	zirconia (ZrO ₂)	zirconia (ZrO ₂)	zirconia (ZrO ₂)
Insertion Loss IL (mean)	≤ 0.1 dB ¹	≤ 0.1 dB ¹	≤ 0.1 dB	≤ 0.1 dB
Insertion Loss IL (maximum)	≤ 0.25 dB ¹	≤ 0.25 dB ¹	≤ 0.25 dB	≤ 0.25 dB
Return Loss RL (mean)	≥ 40 dB	≥ 40 dB	≥ 40 dB	≥ 75 dB
Return Loss RL (minimum)	≥ 35 dB	≥ 35 dB	≥ 35 dB	≥ 65 dB
Connector type	6x LC Duplex	6x LC Duplex	6x LC Duplex	6x LC Duplex
Sleeves	zirconia (ZrO ₂)	zirconia (ZrO ₂)	zirconia (ZrO ₂)	zirconia (ZrO ₂)
Housing colour	turquoise	heather violet	blue	green
Housing material	polymer	polymer	polymer	polymer
Dust caps (duplex)	transparent	transparent	transparent	transparent
Pigtail set l = 1.3 m (12 fibres)	1 set	1 set	1 set	1 set
Fibre colour code	IEC 60304	IEC 60304	IEC 60304	IEC 60304

¹ Insertion Loss (IL) is determined by the latest measurement methods under EFL multimode excitation conditions (EFL = Encircled Flux Launch) at 850 nm in accordance with IEC 61280-4-1.

CONFORMANCE LC IEC 61754-20

REMARKS Laser protection: Optional LCD laser protection clips (metal) can be obtained and retrofitted

As a high-performance patch cable we recommend the FO-DCS LCD Uniboot patch cable.

FO-DCS splice plug-in modules, 24F, 3U/7HP

for FO-DCS modular subracks / modular panel

with 2x 12 pigtailed OM3, OM4, OS2 and 6 LCQ adapters



High-performance
FO-DCS splice plug-in modules,
24F, 3U/7HP

PRODUCT INFORMATION

APPLICATION

FO-DCS splice plug-in modules are suitable for all high-performance applications with duplex signals, particularly in the data centre environment. They find modular application in FO-DCS modular panels (19"/1U) or in FO-DCS subracks (19"/3U, 19"/4U). They are used to accept fibre optic cables which are spliced in-situ. Packing densities of up to 288 fibres on 3U are achieved with these plug-in modules. They are assembled to a very high quality and guarantee optimum values for optical performance (IL/RL).

DESCRIPTION

Polycarbonate (PC) housing with press-fit side panels and polycarbonate (black) or aluminium front panel (3U/7HP). Equipped with 2 splice cassettes for 12 fibres per cassette. Splice cassettes have splice reserve on both sides (cable / pigtail), splice comb and strain relief. Black PC front panels provide labelling strips on both sides of the LCQ ports for customer-specific printing. Fixed with two knurled screws (captive). There is a separate distribution box available for the partition of multi-fibre loose tube cables or for storing the excess tube lengths.

SCOPE OF DELIVERY

Housing with front panel, equipped with 6 LC Quad adapters (ceramic sleeves). Rear fitted with two M12 cable entries. 2 splice cassettes with cover and splice comb (each for 12 fibres). 2 pigtail sets (1.3 m), 12x LC per set (ceramic ferrules).

TECHNICAL DATA

Material:	Polycarbonate (PC)
Front panel:	Polycarbonate or aluminium
Front panel colour:	Black (PC) or aluminium, anodised
Dimensions:	3U/7HP, W x H x D: 35 x 129 x 180 mm (without couplers)
Acceptance capacity:	12 LC duplex ports (24 fibres)
Equipment:	fully equipped

Article No.	Description	Front panel	PU
571530	FO-DCS 3U/7HP splice plug-in module, 6x LCQ, OM3	PC, black	1 pc.
571531	FO-DCS 3U/7HP splice plug-in module, 6x LCQ, OM4	PC, black	1 pc.
571532	FO-DCS 3U/7HP splice plug-in module, 6x LCQ/PC, OS2 (G.652.D)	PC, black	1 pc.
571533	FO-DCS 3U/7HP splice plug-in module, 6x LCQ/APC, OS2 (G.652.D)	PC, black	1 pc.
571630	FO-DCS 3U/7HP splice plug-in module, 6x LCQ, OM3	Alu, anodised	1 pc.
571631	FO-DCS 3U/7HP splice plug-in module, 6x LCQ, OM4	Alu, anodised	1 pc.
571632	FO-DCS 3U/7HP splice plug-in module, 6x LCQ/PC, OS2 (G.652.D)	Alu, anodised	1 pc.
571633	FO-DCS 3U/7HP splice plug-in module, 6x LCQ/APC, OS2 (G.652.D)	Alu, anodised	1 pc.
571599	Labelling sheet A4, perforated (blank)	white	10 pcs.

FO-DCS splice plug-in modules, 24F, 3U/7HP

for FO-DCS modular subracks / modular panel
with 2x 12 pigtailed OM3, OM4, OS2 and 6 LCQ adapters

PRODUCT INFORMATION

FEATURES

TYPE	OM3	OM4	OS2 LC-PC	OS2 LC-APC
Acceptance capacity	24 fibres	24 fibres	24 fibres	24 fibres
Connectors (front side)	24x LC PC 0°	24x LC PC 0°	24x LC PC 0°	24x LC APC 8°
Ferrules	zirconia (ZrO ₂)	zirconia (ZrO ₂)	zirconia (ZrO ₂)	zirconia (ZrO ₂)
Insertion Loss IL (mean)	≤ 0.1 dB ¹	≤ 0.1 dB ¹	≤ 0.1 dB	≤ 0.1 dB
Insertion Loss IL (maximum)	≤ 0.30 dB ¹	≤ 0.30 dB ¹	≤ 0.25 dB	≤ 0.25 dB
Return Loss RL (mean)	≥ 40 dB	≥ 40 dB	≥ 40 dB	≥ 75 dB
Return Loss RL (minimum)	≥ 35 dB	≥ 35 dB	≥ 35 dB	≥ 65 dB
Connector type	6x LC Quad	6x LC Quad	6x LC Quad	6x LC Quad
Sleeves	zirconia (ZrO ₂)	zirconia (ZrO ₂)	zirconia (ZrO ₂)	zirconia (ZrO ₂)
Housing colour	turquoise	heather violet	blue	green
Housing material	polymer	polymer	polymer	polymer
Dust caps (duplex)	transparent	transparent	transparent	transparent
Pigtail set l = 1.3 m (12 fibres)	2 sets	2 sets	2 sets	2 sets
Fibre colour code	IEC 60304	IEC 60304	IEC 60304	IEC 60304

¹ Insertion Loss (IL) is determined by the latest measurement methods under EFL multimode excitation conditions (EFL = Encircled Flux Launch) at 850 nm in accordance with IEC 61280-4-1.

CONFORMANCE

LC IEC 61754-20

REMARKS

Laser protection: Optional LCD laser protection clips (metal) can be obtained and retrofitted

As a high-performance patch cable we recommend the FO-DCS LCD Uniboot patch cable.

DATWYLER DATA CENTRE SOLUTION

FO-DCS loose tube distribution box

for FO-DCS splice plug-in modules 3U/7HP

for loose tube cable partition or storage of excess cable lengths



FO-DCS loose tube distribution box type 1



FO-DCS loose tube distribution box type 2



Screwed cable gland M20 / M25



PMA adapter M12 / M16



Corrugated plastic tube M12

PRODUCT INFORMATION

APPLICATION

The FO-DCS loose tube distribution boxes for FO-DCS splice plug-in modules (3U/7HP) are suitable for the partition of multi-fibre loose tube cables or for the neat and safe storage of the excess tube lengths (approx. 2.0 m) when fibre optic cables with loose tube designs are used which must be spliced in-situ.

These boxes allow for easy and safe splice works on a table in front of the rack. They are mounted in the back area of the racks in most cases.

DESCRIPTION

Plastic boxes available in two sizes (type 1 and type 2).

Loose tube fibre optic cables enter via screwed cable glands (M20 / M25).

Single loose tubes are routed to the plug-in splice modules in corrugated plastic tubes (M12).

SCOPE OF DELIVERY

Plastic box with transparent cover (IP54).

Equipped with internal mounting plate and two bending limitation elements ($r = 50$ mm).

Through holes and dummy plug screws in the side panels.

TECHNICAL DATA

Material:	Plastic
Colour:	Light grey, similar to RAL7035
Dimensions type 1:	W x H x D: 180 x 182 x 90 mm
Dimensions type 2:	W x H x D: 254 x 355 x 111 mm
Equipment type 1:	Mounting plate and bending limitation elements 50 mm, through holes with dummy plug screws: 12x M12, 2x M20, 1x M25
Equipment type 2:	Mounting plate and bending limitation elements 50 mm, through holes with dummy plug screws: 18x M16, 2x M25, 1x M32

Article No.	Description	Colour	PU
470634	FO-DCS loose tube distribution box type 1, 180 x 182 x 90 mm	light grey	1 pc.
470635	FO-DCS loose tube distribution box type 2, 254 x 355 x 111 mm	light grey	1 pc.
470637	Corrugated plastic tube M12	grey	1 m
309602	Screwed cable gland M20 with locknut	grey	1 pc.
309495	Screwed cable gland M25 x 1.5 with locknut	grey	1 pc.
309608	PMA adapter M12 with thread for corrugated plastic tube M12	black	1 pc.
309609	PMA adapter M16 with thread for corrugated plastic tube M12	black	1 pc.



FO-DCS-MTP front panels,
3U/7HP, black

PRODUCT INFORMATION

APPLICATION	FO-DCS 3U/7HP MTP® front panels are suitable for all high-performance applications with duplex and parallel optic signals, e.g. 40/100 GbE, particularly in the data centre environment. The front panels are used in FO-DCS modular panels (19"/1U) or FO-DCS subracks (19"/3U, 19"/4U). They are designed to accept pre-assembled MTP trunk cables, MTP patch cables or MTP fanout cables.	
DESCRIPTION	Polycarbonate (PC) or aluminium front panels, 3U/7HP. The PC front plates provide labelling strips on both sides of the MTP ports for customer-specific printing. Fixed with two knurled screws (captive). Each MTP adapter (Type A: key-up/key-down) is fitted with two dust caps (front/rear).	
SCOPE OF DELIVERY	Front panel equipped with 2, 4 or 8 MTP adapters (Type A: key-up/key-down) and two dust caps per adapter.	
TECHNICAL DATA	Material:	Polycarbonate (PC) or aluminium
	Front panel colour:	Black (PC) or aluminium, anodised
	Dimensions:	3U/7HP, W x H x D: 35 x 129 x 2 mm (without couplers)
	Acceptance capacity:	2, 4 or 8 MTP ports
	Equipment:	fully equipped (plug-and-go)
CONFORMANCE	MTP	IEC 61754-7, IEC 61755-3-31, IEC 611755-3-32

Article No.	Description	Equipped with	Colour	PU
571550	FO-DCS front panel, 2x MTP, 3U/7HP	2x MTP type A turquoise	black	1 pc.
571551	FO-DCS front panel, 2x MTP, 3U/7HP	2x MTP type A magenta	black	1 pc.
571552	FO-DCS front panel, 2x MTP, 3U/7HP	2x MTP type A black	black	1 pc.
571556	FO-DCS front panel, 4x MTP, 3U/7HP	4x MTP type A turquoise	black	1 pc.
571557	FO-DCS front panel, 4x MTP, 3U/7HP	4x MTP type A magenta	black	1 pc.
571558	FO-DCS front panel, 4x MTP, 3U/7HP	4x MTP type A black	black	1 pc.
571560	FO-DCS front panel, 8x MTP, 3U/7HP	8x MTP type A turquoise	black	1 pc.
571561	FO-DCS front panel, 8x MTP, 3U/7HP	8x MTP type A magenta	black	1 pc.
571562	FO-DCS front panel, 8x MTP, 3U/7HP	8x MTP type A black	black	1 pc.
470550	FO-DCS front panel, 4x MTP, 3U/7HP	4x MTP type A black	Alu, anodised	1 pc.
470551	FO-DCS front panel, 8x MTP, 3U/7HP	8x MTP type A black	Alu, anodised	1 pc.
571599	Labelling sheet A4, perforated (blank)		white	10 pcs.

We recommend Datwyler's high-performance FO-DCS MTP-LCD fanout cables and FO-DCS MTP-MTP patch cables to connect the transceivers.

MTP® is a registered brand of US Conec.

FO-DCS mini breakout cables MTP-MTP, 12-144 fibres

for interconnecting FO-DCS plug-in modules

OM3, OM4, OS2



FO-DCS mini breakout cable,
MTP-on-MTP,
12-144 fibres

PRODUCT INFORMATION

APPLICATION

OM3, OM4 and OS2 MTP®-on-MTP mini breakout cables are suitable for all high-performance applications with duplex and parallel optic signals in a data centre environment. For duplex applications, the pre-assembled connectors at either end of the cable are connected to FO-DCS plug-in modules.

The cables can continue to be used in the event of migration to parallel optic applications, e.g. to 40/100 GbE, when the plug-in modules are replaced by FO-DCS MTP front plates.

The FO-DCS mini breakout cables are assembled to a very high quality and guarantee optimum values for optical performance (IL/RL).

DESCRIPTION

Compact, metal-free cable construction with FR/LSOH cable sheath and 12 to 144 fibres.

OM3, OM4 or OS2 versions are available.

Sticker labelling at both cable ends.

The breakout length of individual cables may be defined on the basis of a specific project (max. 4.0 m).

Breakout separation is effected without a divider housing.

All breakouts are assembled using MTP connectors with high-performance 12-fibre Elite® ferrules.

Standard polarisation modes can be type A or type C (other types available on request).

The cables are fitted at both ends with protective sleeves.

SCOPE OF DELIVERY

FO-DCS Mini breakout cables (FR/LSOH) with 12-144 fibres OM3, OM4 or OS2 (G.652.D)

High-performance connector assembly at either end with MTP Elite (male)

Labelled using stickers at both cable ends

Test reports on all MTP connectors

Article No. type A	Article No. type C	Description	Cable sheath colour	PU
470510	570510	FO-DCS mini breakout cable MTP-MTP, 12F, OM3	turquoise	by the metre
470534	570534	FO-DCS mini breakout cable MTP-MTP, 12F, OM4	heather violet	by the metre
470511	570511	FO-DCS mini breakout cable MTP-MTP, 12F, OS2 (G.652.D)	yellow	by the metre
470512	570512	FO-DCS mini breakout cable MTP-MTP, 2x 12F, OM3	turquoise	by the metre
470535	570535	FO-DCS mini breakout cable MTP-MTP, 2x 12F, OM4	heather violet	by the metre
470513	570513	FO-DCS mini breakout cable MTP-MTP, 2x 12F, OS2 (G.652.D)	yellow	by the metre
470525	570525	FO-DCS mini breakout cable MTP-MTP, 4x 12F, OM3	turquoise	by the metre
470536	570536	FO-DCS mini breakout cable MTP-MTP, 4x 12F, OM4	heather violet	by the metre
470526	570526	FO-DCS mini breakout cable MTP-MTP, 4x 12F, OS2 (G.652.D)	yellow	by the metre
470518	570518	FO-DCS mini breakout cable MTP-MTP, 6x 12F, OM3	turquoise	by the metre
470537	570537	FO-DCS mini breakout cable MTP-MTP, 6x 12F, OM4	heather violet	by the metre
470519	570519	FO-DCS mini breakout cable MTP-MTP, 6x 12F, OS2 (G.652.D)	yellow	by the metre
470520	570520	FO-DCS mini breakout cable MTP-MTP, 8x 12F, OM3	turquoise	by the metre
470538	570538	FO-DCS mini breakout cable MTP-MTP, 8x 12F, OM4	heather violet	by the metre
470521	570521	FO-DCS mini breakout cable MTP-MTP, 8x 12F, OS2 (G.652.D)	yellow	by the metre
470522	570522	FO-DCS mini breakout cable MTP-MTP, 12x 12F, OM3	turquoise	by the metre
470539	570539	FO-DCS mini breakout cable MTP-MTP, 12x 12F, OM4	heather violet	by the metre
470523	570523	FO-DCS mini breakout cable MTP-MTP, 12x 12F, OS2 (G.652.D)	yellow	by the metre

MTP® and MTP Elite® are registered brands of US Conec.

FO-DCS mini breakout cables MTP-MTP, 12-144 fibres for interconnecting FO-DCS plug-in modules

OM3, OM4, OS2

PRODUCT INFORMATION

FEATURES

TYPE	MTP-MTP OM3	MTP-MTP OM4	MTP-MTP OS2 (G.652.D)
Breakout length	maximum 4.0 m	maximum 4.0 m	maximum 4.0 m
Connector	n x MTP® pinned	n x MTP pinned	n x MTP pinned
Ferrule type, polishing	Elite® PC 0°	Elite PC 0°	Elite APC 8°
Insertion Loss IL (mean)	≤ 0.15 dB ¹	≤ 0.15 dB ¹	≤ 0.1 dB
Insertion Loss IL (maximum)	≤ 0.3 dB ¹	≤ 0.3 dB ¹	≤ 0.3 dB
Return Loss RL (mean)	≥ 35 dB	≥ 35 dB	≥ 70 dB
Return Loss RL (minimum)	≥ 30 dB	≥ 30 dB	≥ 65 dB
Fibre type	Multimode OM3	Multimode OM4	Singlemode OS2 (G.652.D)
Fibre colour code	in accordance with IEC 60304	in accordance with IEC 60304	in accordance with IEC 60304
Cable sheath	FR/LSOH	FR/LSOH	FR/LSOH

¹ Insertion Loss (IL) is determined by the latest measurement methods under EFL multimode excitation conditions (EFL = Encircled Flux Launch) at 850 nm in accordance with IEC 61280-4-1.

TYPE	Number of fibres	Sheath Ø [mm]	Weight [kg/km]	Min. Bending radius [mm]	Tensile load [N]	Crush resistance continuous [N/10cm]	Crush resistance short term [N/10cm]
Mini breakout cable MTP - MTP	1 x 12	4.5	31	60	400	600	1000
Mini breakout cable MTP - MTP	2 x 12	8.0	72	80	400	600	1000
Mini breakout cable MTP - MTP	4 x 12	9.0	79	80	400	600	1000
Mini breakout cable MTP - MTP	6 x 12	11.2	126	100	600	600	1000
Mini breakout cable MTP - MTP	8 x 12	13.5	178	120	600	600	1000
Mini breakout cable MTP - MTP	12 x 12	17.5	285	160	600	600	1000

CONFORMANCE	MTP	IEC 61754-7, IEC 61755-3-31, IEC 611755-3-32
REMARKS	Polarity methods:	Fibre light propagation in accordance with TIA-568-C.3 type A and type C
ENVIRONMENTAL CONDITIONS	Zero halogen: Smoke density: Corrosivity of gases evolved during combustion: Fire performance:	in accordance with 60754-1 in accordance with IEC 61034 in accordance with IEC 60754-2 in accordance with IEC 60332-1-2 and IEC 60332-3-22 Cat. A

MTP® and MTP Elite® are registered brands of US Conec.

FO-DCS universal cables MTP-MTP, 12-48 fibres for interconnecting FO-DCS plug-in modules

OM3, OM4, OS2



FO-DCS universal cable,
MTP-on-MTP,
12-48 fibres

PRODUCT INFORMATION

APPLICATION

OM3, OM4 and OS2 MTP®-on-MTP universal cables are suitable for all high-performance applications with duplex and parallel optic signals in a data centre environment. They are particularly used when installation requires sturdy, metal-free indoor and outdoor cables that provide enhanced crush resistance and rodent protection. For duplex applications, the pre-assembled connectors at either end of the cable are connected to FO-DCS plug-in modules. The cables can continue to be used in the event of migration to parallel optic applications, e.g. to 40/100 GbE, when the plug-in modules are replaced by FO-DCS MTP front plates. The FO-DCS universal cables are assembled to a very high quality and guarantee optimum values for optical performance (IL/RL).

DESCRIPTION

Compact, metal-free cable construction with FR/LSOH cable sheath and 12 to 48 fibres. OM3, OM4 or OS2 versions are available. Sticker labelling at both cable ends. The breakout length of individual cables may be defined on the basis of a specific project (max. 4.0 m). Breakout separation is effected without a divider housing. All breakouts are assembled using MTP connectors with high-performance 12-fibre Elite® ferrules. Standard polarisation modes can be type A or type C (other types available on request). The cables are fitted at both ends with protective sleeves.

SCOPE OF DELIVERY

FO-DCS universal cables (FR/LSOH) with 12-48 fibres OM3, OM4 or OS2
High-performance connector assembly at either end with MTP Elite (male)
Labelled using stickers at both cable ends
Test reports on all MTP connectors

Article No. type A	Article No. type C	Description	Cable sheath colour	PU
570641	570644	FO-DCS universal cable MTP-MTP, 12F, OM3	turquoise	by the metre
570651	570654	FO-DCS universal cable MTP-MTP, 12F, OM4	heather violet	by the metre
570661	570664	FO-DCS universal cable MTP-MTP, 12F, OS2 (G.652.D)	yellow	by the metre
570642	570645	FO-DCS universal cable MTP-MTP, 2x 12F, OM3	turquoise	by the metre
570652	570655	FO-DCS universal cable MTP-MTP, 2x 12F, OM4	heather violet	by the metre
570662	570665	FO-DCS universal cable MTP-MTP, 2x 12F, OS2 (G.652.D)	yellow	by the metre
570643	570646	FO-DCS universal cable MTP-MTP, 4x 12F, OM3	turquoise	by the metre
570653	570656	FO-DCS universal cable MTP-MTP, 4x 12F, OM4	heather violet	by the metre
570663	570666	FO-DCS universal cable MTP-MTP, 4x 12F, OS2 (G.652.D)	yellow	by the metre

other versions on request

MTP® and MTP Elite® are registered brands of US Conec.

FO-DCS universal cables MTP-MTP, 12-48 fibres
for interconnecting FO-DCS plug-in modules

OM3, OM4, OS2

PRODUCT INFORMATION

FEATURES

TYPE	MTP-MTP OM3	MTP-MTP OM4	MTP-MTP OS2 (G.652.D)
Breakout length	maximum 4.0 m	maximum 4.0 m	maximum 4.0 m
Connector	n x MTP® pinned	n x MTP pinned	n x MTP pinned
Ferrule type, polishing	Elite® PC 0°	Elite PC 0°	Elite APC 8°
Insertion Loss IL (mean)	≤ 0.15 dB ¹	≤ 0.15 dB ¹	≤ 0.1 dB
Insertion Loss IL (maximum)	≤ 0.3 dB ¹	≤ 0.3 dB ¹	≤ 0.3 dB
Return Loss RL (mean)	≥ 35 dB	≥ 35 dB	≥ 70 dB
Return Loss RL (minimum)	≥ 30 dB	≥ 30 dB	≥ 65 dB
Fibre type	Multimode OM3	Multimode OM4	Singlemode OS2 (G.652.D)
Fibre colour code	in accordance with IEC 60304	in accordance with IEC 60304	in accordance with IEC 60304
Cable sheath	FR/LSOH	FR/LSOH	FR/LSOH

¹ Insertion Loss (IL) is determined by the latest measurement methods under EFL multimode excitation conditions (EFL = Encircled Flux Launch) at 850 nm in accordance with IEC 61280-4-1.

TYPE	Number of fibres	Sheath Ø [mm]	Weight [kg/km]	Min. Bending radius [mm]	Tensile load [N]	Crush resistance continuous [N/10cm]	Crush resistance short term [N/10cm]
Universal cable MTP - MTP	1 x 12	7.6	68	115	1000	2000	5000
Universal cable MTP - MTP	2 x 12	9.5	96	140	1000	2000	5000
Universal cable MTP - MTP	4 x 12	11.4	148	175	6000	3000	5000

CONFORMANCE	MTP	IEC 61754-7, IEC 61755-3-31, IEC 611755-3-32
REMARKS	Polarity methods:	Fiber light propagation in accordance with TIA-568-C.3 type A and type C
ENVIRONMENTAL CONDITIONS	Zero halogen:	in accordance with 60754-1/-2
	Smoke density:	in accordance with IEC 61034-1/-2
	Corrosivity of gases evolved during combustion:	in accordance with IEC 60754-2
	Fire performance:	in accordance with IEC 60332-1-2 and IEC 60332-3 Cat. C

MTP® and MTP Elite® are registered brands of US Conec.

FO-DCS fanout cables MTP-LCD, 12 fibres

for connecting active components

OM3, OM4, OS2



FO-DCS fanout cable,
MTP-on-LCDU,
12 fibres

PRODUCT INFORMATION

APPLICATION

OM3, OM4 und OS2 MTP®-on-LCD fanout cables are suitable for all high-performance applications in a data centre environment.
The connection between six duplex ports and one parallel optic port enables quick and space-saving cabling of active components such as routers, switches, servers and storage systems.
The fanout cables are assembled to a very high quality and guarantee optimum values for optical performance (IL/RL).

DESCRIPTION

Thin, very flexible fibre-optic fanout cable (round cable, Ø 3.0 mm) with 12 fibres.
Low fire load due to its halogen-free flame-retardant LSOH sheath.
OM3, OM4 and OS2 versions are available with 2.5 m standard length (other lengths on request).
Standard polarisation modes can be type A or type C.
Sticker labelling at both cable ends.
Breakout separation is effected with a thin divider housing.
The legs (Ø 2.2 mm) with LCD Uniboot (LCDU) plugs are numbered (1 – 6).
The legs can be ordered graded in length or of equal length.
Project-specific assemblies are available on request.

SCOPE OF DELIVERY

FO-DCS fanout cable (FR/LSOH) with 12 fibres OM3, OM4 or OS2 (G.652.D)
High-performance connector assembly with MTP and LCD Uniboot
Labelled using stickers at both cable ends
Test reports (IL/RL) on all connectors

Article No. type A	Article No. type C	Description	Cable sheath colour	Length [m]
571201	571211	FO-DCS fanout cable MTP/f-LCDU, 12F, OM3, graded	turquoise	2.5
571202	571212	FO-DCS fanout cable MTP/f-LCDU, 12F, OM3, equal	turquoise	2.5
571203	571213	FO-DCS fanout cable MTP/f-LCDU, 12F, OM4, graded	heather violet	2.5
571204	571214	FO-DCS fanout cable MTP/f-LCDU, 12F, OM4, equal	heather violet	2.5
571205	571215	FO-DCS fanout cable MTP/f-LCDU, 12F, OS2 (G.652.D), graded	yellow	2.5
571206	571216	FO-DCS fanout cable MTP/f-LCDU, 12F, OS2 (G.652.D), equal	yellow	2.5

MTP® is a registered brand of US Conec.

PRODUCT INFORMATION

FEATURES

	TYPE	OM3	OM4	OS2 LC-PC
	Fibre number	12 fibres	12 fibres	12 fibres
	Fibre type	MM 50/125 OM3	MM 50/125 OM4	SM 9/125 G.652.D OS2
	Fibre colour code	IEC 60304	IEC 60304	IEC 60304
Legs (side A)	Connector	1x MTP® unpinned	1x MTP unpinned	1x MTP unpinned
	Ferrule type, polishing	Elite® PC 0°	Elite PC 0°	Elite APC 8°
	Insertion Loss IL (mean)	0.15 dB ¹	0.15 dB ¹	0.1 dB
	Insertion Loss IL (maximum)	≤ 0.3 dB ¹	≤ 0.3 dB ¹	≤ 0.3 dB
	Return Loss RL (mean)	35 dB	35 dB	70 dB
	Return Loss RL (minimum)	≥ 30 dB	≥ 30 dB	≥ 65 dB
	Housing colour (MTP)	turquoise	magenta	mustard
	Cable diameter	1x 3.0 mm	1x 3.0 mm	1x 3.0 mm
Legs (side B)	Connector type, polishing	6 x LCDU PC 0°	6 x LCDU PC 0°	6 x LCDU PC 0°
	Ferrule	zirconia (ZrO ₂)	zirconia (ZrO ₂)	zirconia (ZrO ₂)
	Insertion Loss IL (mean)	≤ 0.1 dB ¹	≤ 0.1 dB ¹	≤ 0.1 dB
	Insertion Loss IL (maximum)	≤ 0.25 dB ¹	≤ 0.25 dB ¹	≤ 0.25 dB
	Return Loss RL (mean)	40 dB	40 dB	40 dB
	Return Loss RL (minimum)	≥ 35 dB	≥ 35 dB	≥ 35 dB
	Housing colour (LCDU)	beige	beige	blue
	Legs diameter	6x 2.2 mm	6x 2.2 mm	6x 2.2 mm

¹ Insertion Loss (IL) is determined by the latest measurement methods under EFL multimode excitation conditions (EFL = Encircled Flux Launch) at 850 nm in accordance with IEC 61280-4-1.

CONFORMANCE	MTP LC	IEC 61754-7, IEC 61755-3-31, IEC 611755-3-32 IEC 61754-20
REMARKS	Polarity methods:	Fibre light propagation in accordance with TIA-568-C.3 type A and type C
ENVIRONMENTAL CONDITIONS	Zero halogen: Smoke density: Corrosivity of gases evolved during combustion: Fire performance:	in accordance with 60754-1 in accordance with IEC 61034 in accordance with IEC 60754-2 in accordance with IEC 60332-1-2 and IEC 60332-3-22 Cat. A

MTP® and MTP Elite® are registered brands of US Conec.

FO-DCS patch cables MTP-MTP, 12 fibres

Patch- and connection cable für parallel optic links

OM3, OM4



FO-DCS patch cable,
MTP-on-MTP,
12 fibres

PRODUCT INFORMATION

APPLICATION

OM3, OM4 and OS2 MTP®-on-MTP patch cables are suitable for all high-performance applications with parallel optic signals in a data centre environment.
The round patch cables are pre-assembled with high-performance MTP connectors (female) at both ends.
They are assembled to a very high quality and guarantee optimum values for optical performance (IL/RL).

DESCRIPTION

Thin, very flexible fibre-optic patch cable (round cable, Ø 3.0 mm) with 12 fibres.
Low fire load due to its halogen-free flame-retardant LS0H sheath.
OM3 and OM4 versions are available with up to 5 m standard lengths (other lengths on request).
Sticker labelling at both cable ends.
Standard polarisation modes can be type A, B or type C.

SCOPE OF DELIVERY

Parallel optic patch cable (FR/LS0H) with 12 fibres OM3 or OM4
High-performance connector assembly with MTP Elite® (female) at either end
Labelled using stickers at both cable ends
Supplied with test report

Article No. type A	Article No. type B	Article No. type C	Description	Cable sheath colour	Length [m]
570901	570911	570921	FO-DCS patch cable MTP, 12F, OM3	turquoise	1.0
570931	570941	570951	FO-DCS patch cable MTP, 12F, OM4	heather violet	1.0
570902	570912	570922	FO-DCS patch cable MTP, 12F, OM3	turquoise	2.0
570932	570942	570952	FO-DCS patch cable MTP, 12F, OM4	heather violet	2.0
570903	570913	570923	FO-DCS patch cable MTP, 12F, OM3	turquoise	3.0
570933	570943	570953	FO-DCS patch cable MTP, 12F, OM4	heather violet	3.0
570904	570914	570924	FO-DCS patch cable MTP, 12F, OM3	turquoise	4.0
570934	570944	570954	FO-DCS patch cable MTP, 12F, OM4	heather violet	4.0
570905	570915	570925	FO-DCS patch cable MTP, 12F, OM3	turquoise	5.0
570935	570945	570955	FO-DCS patch cable MTP, 12F, OM4	heather violet	5.0

MTP® and MTP Elite® are registered brands of US Conec.

PRODUCT INFORMATION

FEATURES

TYPE	MTP-MTP OM3	MTP-MTP OM4
Connector side A and B	MTP® unpinned	MTP unpinned
Ferrule type, polishing	Elite® PC 0°	Elite PC 0°
Insertion Loss IL (mean)	≤ 0.15 dB ¹	≤ 0.15 dB ¹
Insertion Loss IL (maximum)	≤ 0.3 dB ¹	≤ 0.3 dB ¹
Return Loss RL (mean)	≥ 35 dB	≥ 35 dB
Return Loss RL (minimum)	≥ 30 dB	≥ 30 dB
Fibre type	Multimode OM3	Multimode OM4
Fibre colour code	conforms to IEC 60304	conforms to IEC 60304
Cable sheath	FR/LSOH	FR/LSOH

¹ Insertion Loss (IL) is determined by the latest measurement methods under EFL multimode excitation conditions (EFL = Encircled Flux Launch) at 850 nm in accordance with IEC 61280-4-1.

CONFORMANCE	MTP	IEC 61754-7, IEC 61755-3-31, IEC 611755-3-32
REMARKS	Polarity methods:	Fiber light propagation in accordance with TIA-568-C.3 type A, B and type C
ENVIRONMENTAL CONDITIONS	Zero halogen:	in accordance with 60754-1
	Smoke density:	in accordance with IEC 61034
	Corrosivity of gases evolved during combustion:	in accordance with IEC 60754-2
	Fire performance:	in accordance with IEC 60332-1-2 and IEC 60332-3-22 Cat. A

MTP® and MTP Elite® are registered brands of US Conec.

FO-DCS patch cables LCD-LCD, 2 fibres

High-performance

OM3, OM4, OS2



High-performance FO-DCS patch cables, pre-assembled with LCD Uniboot connectors at either end, OM3 and OS2 versions

PRODUCT INFORMATION

APPLICATION

OM3, OM4 and OS2 (G.652.D) LCD-on-LCD patch cables are suitable for all high-performance applications with duplex signals in the data centre environment. The round patch cables are assembled with LCD Uniboot connectors (High Performance) at both ends. The patch cables are assembled to a very high quality and guarantee optimum values for optical performance (IL/RL).

DESCRIPTION

Compact cable design with FR/LSOH cable sheath (Ø 2.2 mm) and 2 fibres. OM3, OM4 and OS2 (G.652.D) versions are available with standard lengths up to 10 m (G.657.A1 or G.657.A2 fibres and other lengths on request). Patch cables come with straight polarity (A to A) or cross polarity (A to B). Sticker labelling at both cable ends.

SCOPE OF DELIVERY

Duplex patch cable (FR/LSOH) with 2 fibres OM3, OM4 or OS2
High-performance connector assembly with LCD Uniboot at either end
Labelled using stickers at both cable ends
Packed and labelled in clear plastic sleeve
Supplied with test report

Description	Colour	Type	Length in m / Article No.										
			1	2	3	4	5	6	7	8	9	10	
FO-DCS patch cable LCDU, PC, 2F, OM3	turquoise	A to A	570801	570802	570803	570804	570805	570806	570807	570808	570809	570810	
FO-DCS patch cable LCDU, PC, 2F, OM3	turquoise	A to B	570821	570822	570823	570824	570825	570826	570827	570828	570829	570830	
FO-DCS patch cable LCDU, PC, 2F, OM4	violet	A to A	570841	570842	570843	570844	570845	570846	570847	570848	570849	570850	
FO-DCS patch cable LCDU, PC, 2F, OM4	violet	A to B	570861	570862	570863	570864	570865	570866	570867	570868	570869	570870	
FO-DCS patch cable LCDU, PC, 2F, OS2	yellow	A to A	570721	570722	570723	570724	570725	570726	570727	570728	570729	570730	
FO-DCS patch cable LCDU, PC, 2F, OS2	yellow	A to B	570741	570742	570743	570744	570745	570746	570747	570748	570749	570750	
FO-DCS patch cable LCDU, APC, 2F, OS2	yellow	A to A	570761	570762	570763	570764	570765	570766	570767	570768	570769	570770	
FO-DCS patch cable LCDU, APC, 2F, OS2	yellow	A to B	570781	570782	570783	570784	570785	570786	570787	570788	570789	570790	
FO-DCS patch cable LCDU, APC/PC, 2F, OS2	yellow	A to A	570701	570702	570703	570704	570705	570706	570707	570708	570709	570710	
FO-DCS patch cable LCDU, APC/PC, 2F, OS2	yellow	A to B	570711	570712	570713	570714	570715	570716	570717	570718	570719	570720	

PRODUCT INFORMATION

FEATURES

TYPE	LCD Uniboot, OM3	LCD Uniboot, OM4	LCD Uniboot, OS2	LCD-APC Uniboot, OS2
Connector side A and B	LCD Uniboot	LCD Uniboot	LCD Uniboot	LCD-APC Uniboot
Ferrule type, polishing	zirconia (ZrO ₂), PC 0°	zirconia (ZrO ₂), PC 0°	zirconia (ZrO ₂), PC 0°	zirconia (ZrO ₂), APC 8°
Insertion Loss IL (mean)	≤ 0.1 dB ¹	≤ 0.1 dB ¹	≤ 0.1 dB	≤ 0.1 dB
Insertion Loss IL (maximum)	≤ 0.25 dB ¹	≤ 0.25 dB ¹	≤ 0.25 dB	≤ 0.25 dB
Return Loss RL (mean)	≥ 40 dB	≥ 40 dB	≥ 40 dB	≥ 75 dB
Return Loss RL (minimum)	≥ 35 dB	≥ 35 dB	≥ 35 dB	≥ 65 dB
Fibre type	MM 50/125 OM3	MM 50/125 OM4	SM 9/125 G.652.D	SM 9/125 G.652.D
Number of fibres	2 fibres	2 fibres	2 fibres	2 fibres
Fibre colour code	in acc. with IEC 60304	in acc. with IEC 60304	in acc. with IEC 60304	in acc. with IEC 60304
Cable sheath	FR/LSOH	FR/LSOH	FR/LSOH	FR/LSOH
Ø cable	2.2 mm	2.2 mm	2.2 mm	2.2 mm
Sheath colour	turquoise	heather violet	yellow	yellow
Housing colour (LCDU)	beige	beige	blue	green

¹ Insertion Loss (IL) is determined by the latest measurement methods under EFL multimode excitation conditions (EFL = Encircled Flux Launch) at 850 nm in accordance with IEC 61280-4-1

CONFORMANCE	LC	IEC 61754-20
REMARKS	Polarity methods:	Fiber light propagation in accordance with TIA-568-C.3 and EN 50174-1:2009
ENVIRONMENTAL CONDITIONS	Zero halogen: Smoke density: Corrosivity of gases evolved during combustion: Fire performance:	in accordance with IEC 60754-1 in accordance with IEC 61034 in accordance with IEC 60754-2 in accordance with IEC 60332-1-2, IEC 60332-3-22 Cat. A

FO cleaning tools



Fig. 1:
Reel Cleaner



Fig. 2:
MPO/MTP cleaning device



Fig. 3:
Single-fibre connector
cleaning device



Fig. 4:
Cleaning rod for sleeve

PRODUCT INFORMATION

APPLICATION

The cleanliness of FO connectors is critical for satisfactory optical performance and long-term trouble-free transmission. Connectors that are dirty, worn or scratched due to improper use will have a negative effect on optical performance because the Insertion Loss (IL) increases whilst the Return Loss (RL) falls.

This topic is so important that it has found its way into all FO-related cabling standards. The standards point out that professional cleaning tools are necessary to ensure successful acceptance tests and trouble-free patching.

For professional on-site cleaning of FO connectors (e.g. MPO/MTP®) the equipment as featured in Datwyler's FO accessories portfolio (see below) is particularly suitable.

Article No.	Fig.	Description	Items cleaned / method	PU
1411400	1	Reel Cleaner	FO connector	1 pc.
1411401	-	Replacement reels for Reel Cleaner		6 pcs.
415627	2	FO connector cleaning device for MPO	FO connector and through adapter	1 pc.
415628	3	FO connector cleaning device for 2.5 mm	FO connector and through adapter	1 pc.
415629	-	FO connector cleaning device for 1.25 mm	FO connector and through adapter	1 pc.
1411404	4	Cleaning rod for 2.5 mm	Sleeve in connector	10 pcs.
1411405	-	Cleaning rod for 1.25 mm	Sleeve in connector	10 pcs.

MTP® is a registered brand of US Conec.



HIGH-PERFORMANCE WIRELESS NETWORKS

WIRELESS NETWORKS THAT WILL KEEP PACE WITH YOUR BUSINESS GROWTH

Wire transmission no longer meets all the demands of modern in-building communication systems. Wireless connectivity (WLAN, Wi-Fi) is essential to provide unrestricted mobility within a building. The intrinsic strengths of these two transmission methods make them both mutually dependent and complementary.

With our skilled and experienced system, planning and installation partners, we can supply all the equipment required for your Wireless LAN infrastructure plus all the network components needed. This means that everything you need for in-building communication systems in any public or commercial building and at all system levels is available from a single source: from the heart of the system, the cable, through the passive connecting and system components of your LAN, to active wireless communication technology.



Active support for our customers:

- Advice on selecting the components required
- Technical planning assistance and simulations
- Site surveys to verify the planning data
- Installation
- Acceptance testing



**Become our
Wireless Solutions Partner
and get registered as
a reseller**

Benefit from the many advantages:

- intensive training on products
- technical support
- project back-up

WIRELESS SOLUTIONS FOR HIGH REQUIREMENTS

Mobility has become an integral part of modern day-to-day business. Employees, customers and partners take for granted the existence of wireless access points, and what's more, they are dependent on it. The massive increase of smartphones and tablet PCs in the workplace impressively proves this trend. Forward-looking companies have recognised the signs of the times and responded accordingly.

Trend-setting array solutions provide optimum conditions with their above-average range, coverage and bandwidth. The system is ideally suited for professional use in offices, factory buildings, conference halls, schools, hospitals and hotels.

Bandwidth-hungry applications such as IP television (IPTV), Video on Demand and Voice over WiFi in particular benefit from trouble-free operation with superlative "Quality of experience", even when being simultaneously used by a lot of people and over a large coverage area.



WIFI-ARRAYS

Unlike conventional access points, the Xirus arrays provide many already integrated devices: from 2 up to 16 radio cells, highly sensitive directional antennas, multi-gigabit switch, controller, firewall, spectrum analyser, and threat sensor.

The advantages of this all-in-one architecture are obvious: less arrays, less cables and less switch ports will result in less investment in communications infrastructure – already in the project implementation period.



Up to 7.2 Gbit/s bandwidth in the 802.11a/b/g+n/ac range ensure WiFi coverage of up to 1920 users and an area of over 100 x 100 metres.

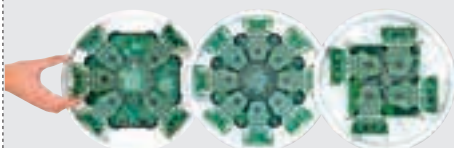

POWER SUPPLY

There are two ways of supplying power to the WiFi arrays: You can use a PoE (Power over Ethernet) adapter or a multi-port PoE switch



Power over Gigabit Ethernet (PoGE)

The PogE system is a simple and cost-effective method of supplying power to the WiFi arrays. This method is using the existing data cable.

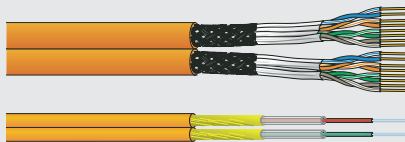

High-performance data cables

Arrays can be connected with fibre optic cables or high-performance copper data cables.

MANAGEMENT

Xirus Management System (XMS) provides a platform for the centralized management of arrays. Network administrators use it for efficient and centralized configuration, administration and control of Xirus WLAN networks.

Main functions:

- Web-based user interface
- Network discovery
- Configuration management
- Station assurance
- Network assurance
- Intrusion detection
- Real-time monitoring
- Wireless network mapping
- Drill-down reports
- Safety monitoring and management

On-premise installation



or
Cloud based management



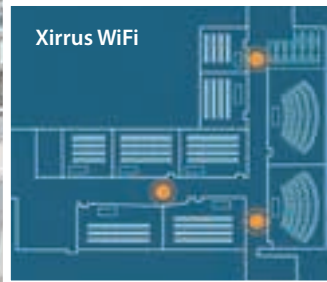
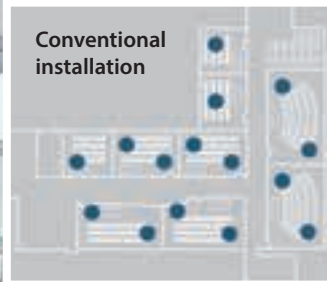
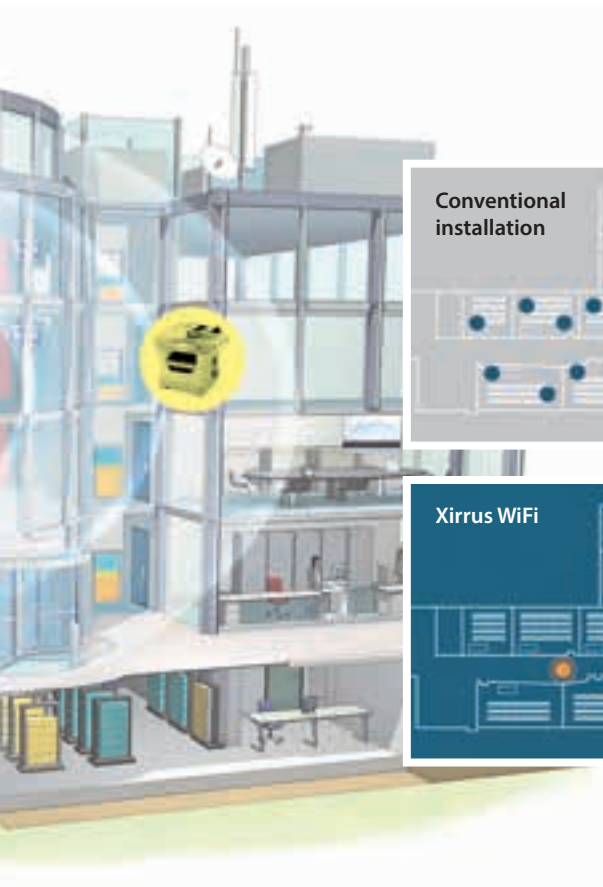

BENEFITS AT A GLANCE

Less WiFi equipment

- up to 10.4 Gbit/s bandwidth
- higher range and coverage
- up to 1024 users per array
- wireless mesh
- access points can be configured and removed individually (IAP)
- integrated Gigabit switch
- integrated WiFi controller

Security

- intelligence at the interface
- integrated firewall
- integrated WiFi threat sensor

Professional support

- measurement
- network planning
- checking

Investment protection

- modular, expandable design
- new standards by means of hardware upgrades and software updates
- arrays suitable for 802.11ac/ad
- switchable between 2.4 and 5 GHz

Copper

Fibre Optics

Cabinets & Racks

Data Centre

Wireless

Multimedia

General Information

HOUSINGS AND ACCESSORIES

You can choose from a wide range of housings for indoor and outdoor use as well as various installation devices. This ensures that the arrays are well protected from environmental influences and damage.

Indoors

The indoor housing can easily be mounted on or in the ceiling.



Outdoors

- Protection rating IP65 for protection against dust and rough environmental conditions.
- -40° C up to +55° C
- various types of antenna available



SERVICES

Datwyler complements its services with professional support when measuring a building, designing the network and checking the network installed.

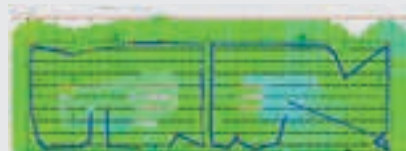

Site Survey

Measurement is carried out with the arrays directly in the building in which WiFi is to be installed.

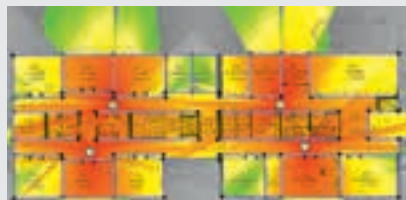

Simulation

A simulation based on building plans or site maps is carried out to determine the number of arrays required.

Checks

After the installation, the range and coverage is measured and the WiFi network is tested to guarantee the highest possible quality.

MAINTENANCE CONTRACTS

Protect your investment with a maintenance contract. This is the way to keep arrays and software up to date at no extra cost.



Comprehensive services

Over and above the standard warranty, maintenance contracts provide services which include the fastest possible support, replacement of defective hardware within one working day, and all software updates.



Upgrade and updates

Hardware upgrades and software updates ensure that your WiFi arrays will always be fully compliant with the latest standards.



PRODUCT INFORMATION

APPLICATION

The cost-efficient Xirrus WiFi access points are designed for quick and easy deployment of wireless networks. They are particularly suitable for use in offices, hotel rooms, dorms, smaller classrooms and similar applications with low user density but high demands on device variety and bandwidth.

DESCRIPTION

These APs with integrated controller deliver the highest flexibility and performance for networks with a small to medium density of users. Xirrus access points have 2 radios with omnidirectional antennas and can support up to Gigabit speeds.

The devices support the new WiFi standard 802.11ac and are downwardly compatible. They distinguish themselves by a high level of security, which is increased by the application control with deep package inspection (DPI). All radios are multi-state capable, so that for a switch from 2.4 to 5 GHz the correct settings can be found for each network. Wireless controller, multi-gigabit switch, firewall, threat sensor and spectrum analyzer are also integrated.

The access points have the same functionality as the modular Xirrus WiFi arrays and can be easily integrated in bigger WiFi networks.

- Access point comprises
- 2 radios, 300, 450, 867 Mbit/s per radio, depending on the model
 - integrated WiFi controller
 - array operating system, including analysis and control software

ACCESSORIES

Power is supplied with PoE / PoE + on a switch or midspan injector.

TECHNICAL SPECIFICATION

Specifications	XR-520	XR-620	XR-630
Housing size	19,6 cm	19,6 cm	19,6 cm
Integrated radios	2	2	2
On-board 802.11n radio cells	2.4 GHz & 5 GHz	2.4 GHz & 5 GHz	2.4 GHz & 5 GHz
switchable to 802.11ac	no	yes	yes
Maximum WiFi bandwidth	600 Mbit/s	1.3 Gbit/s	2.6 Gbit/s
Integrated WiFi threat sensor	yes	yes	yes
Integrated antennas	4	4	6
Array OS Operating System	integrated	integrated	integrated
Maximum WiFi backhaul link	300 Mbit/s	867 Mbit/s	1.35 Gbit/s
Integrated switch ports	1	2	2
GigE uplink ports	1	2	2
Maximum number of users	240	240	240
Maximum input power	12,5 W	19 W	24 W



PRODUCT INFORMATION

APPLICATION

The Xirrus WiFi arrays are designed mainly for wireless networks with high user density, a wide variety of devices and/or high bandwidth requirements (video applications, for example).

DESCRIPTION

These wireless arrays are the first modular WiFi products of their kind. They are characterized by upgradeability, excellent scalability, high performance, and integrated safety. They consist of modular multi-state integrated access points (2.4 GHz and 5 GHz) with powerful directional antennas, wireless controller, multi-gigabit switch, firewall, threat sensor and spectrum analyzer in a single, modular housing.

Their fully modular construction and software controlled via Web interface allow extremely flexible use of the array and sophisticated fine-tuning to each operational scenario.

Array comprises:

- WiFi array, the choice of 2 to a maximum of 16 integrated access points, depending on configuration, with up to 1.3 Gbit/s
- integrated WiFi controller
- standard mounting kit for ceiling mounting
- array operating system, including analysis and control software
- optional: Premium Support for hardware and software

Due to the modular design of the WLAN portfolio the WiFi arrays are already geared up to future WiFi standards, therefore providing good investment protection.

ACCESSORIES

PoE adapter (see: WiFi accessories - power supply).

The use of standard PoE units is not feasible for a power supply via PoE, as the arrays have a different energy requirement.

TECHNICAL SPECIFICATION

Specifications	XR-2xx6	XR-4xx6	XR-6xx0
Housing size	28,6 cm	33 cm	43 cm
AP slots	2-4	4-8	8-16
On-board 802.11n radio cells	2.4 GHz & 5 GHz	2.4 GHz & 5 GHz	2.4 GHz & 5 GHz
Maximum WiFi bandwidth	5.2 Gbit/s	10.4 Gbit/s	10.4 Gbit/s
Integrated WiFi threat sensor	yes	yes	yes
Integrated antennas	4-12	8-24	16-48
Array OS Operating System	integrated	integrated	integrated
Maximum WiFi backhaul link	5.2 Gbit/s	10.4 Gbit/s	10.4 Gbit/s
Integrated switch ports	4	8	16
GigE uplink ports	1	2	4 + 1x 10GigE FO
Maximum number of users	512	1024	1920
Maximum input power	26-38 W	33-50 W	58 W

WiFi arrays

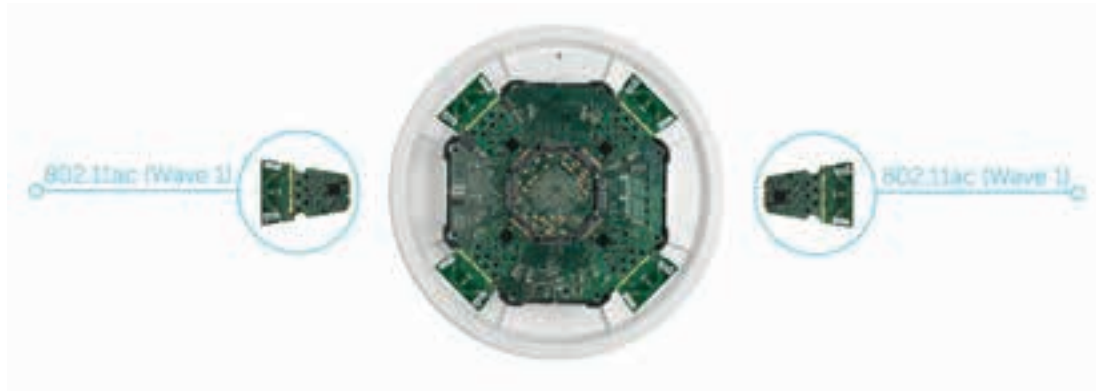

PRODUCT INFORMATION

VERSIONS

Article No.	Designation	Brief description	Integrated APs	Upgrades (APs)
103682	XR-520	Wireless access point with two 2x2 (300 Mbps) 802.11n radios	2	no
103651	XR-620	Wireless access point with two 2x2 (867 Mbps) 802.11ac capable radios, licensed for 802.11n	2	no
103693	XR-630	Wireless access point with two 3x3 (1.3 Gbps) 802.11ac capable radios, licensed for 802.11n	2	no
103649	XR-2226	Wireless array with 2 2x2 (867 Mbps) 802.11ac capable radios, licensed for 802.11n	2	yes, up to 4
103648	XR-2236	Wireless array with 2 3x3 (1.3 Gbps) 802.11ac capable radios, licensed for 802.11n	2	yes, up to 4
103647	XR-2426	Wireless array with 4 2x2 (867 Mbps) 802.11ac capable radios, licensed for 802.11n	4	no
103646	XR-2436	Wireless array with 4 3x3 (1.3 Gbps) 802.11ac capable radios, licensed for 802.11n	4	no
103645	XR-4426	Wireless array with 4 2x2 (867 Mbps) 802.11ac capable radios, licensed for 802.11n	4	yes, up to 8
103644	XR-4436	Wireless array with 4 3x3 (1.3 Gbps) 802.11ac capable radios, licensed for 802.11n	4	yes, up to 8
103643	XR-4826	Wireless array with 8 2x2 (867 Mbps) 802.11ac capable radios, licensed for 802.11n	8	no
103642	XR-4836	Wireless array with 8 3x3 (1.3 Gbps) 802.11ac capable radios, licensed for 802.11n	8	no
103699	XR-520H	Outdoor wireless access point with two 2x2 (300 Mbps) 802.11n radios (without external antennas*)	2	no
103658	XR-2425H	Outdoor wireless array with four 2x2 (300 Mbps) 802.11n radios (without external antennas*)	4	no

Further wireless arrays and outdoor wireless arrays are available on request.

*External antennas: see Outdoor arrays and accessories

All wireless access points and wireless arrays connected to a PoE injector need the following accessory:

XS-PWR-xx	Country-specific power cord and plug
XP1-MSI-xxx	Power over Ethernet Midspan Injector. See WiFi Accessories – Power Supply

OTHER TECHNICAL DATA

Environmental requirements Outside temperature: 0 to 55°C
Atmospheric humidity: 0 to 90% (non-condensing)

Management interfaces

- Command Line
- Web Interface
- Xirrus Management System (On-premise or Cloud)

Conformity

CE marking:
Europe: EN 55022, EN 55024
Safety: UL 60950-1:2003
EN 60950:2000
EMV and immunity (Class A)
Europe: EN 55022, EN 55024



PRODUCT INFORMATION

APPLICATION	The outdoor arrays and access points are designed to meet requirements for providing wireless coverage outdoors – for example in playgrounds, campus quads and stadiums.
DESCRIPTION	<p>The hardened array includes software programmable radios (2.4 GHz and 5 GHz) with two lightning protected type RP-TNC connectors each. External antennas are required.</p> <p>Main features of outdoor arrays:</p> <ul style="list-style-type: none"> - Seamless connectivity for 802.11a/b/g/n devices - Radios with 2x2 MIMO up to 1.2 Gbit/s - Dual Core processor with integrated controller - Operating temperature -40°C to +55°C, IP65 rated, weather and dust sealed - Software programmable radios operate in 2.4 GHz and 5 GHz bands - Application Control, Bonjour gateway, IDS/IPS, and Cloud or On-premise management included
ACCESSORIES	In addition, a IP65 rated outdoor enclosure is available for all wireless arrays. This enclosure provides its own fan and heater, so that even „indoor“ arrays can be used outdoors.

TECHNICAL SPECIFICATION	Specifications	XR-520 H	XR-2425 H
	Housing size	26 cm	30 cm
	AP slots	2	4
	On-board 802.11n radio cells	2.4 GHz & 5 GHz	2.4 GHz & 5 GHz
	Maximum WiFi bandwidth	600 Mbit/s	1.2 Gbit/s
	Integrated WiFi threat sensor	yes	yes
	Integrated antennas	4	8
	Array OS Operating System	integrated	integrated
	Maximum WiFi backhaul link	300 Mbit/s	600 Mbit/s
	Integrated switch ports	2	4
	GigE uplink ports	1	2
	Maximum number of users	240	960
	Maximum input power	26-38 W	33-50 W

EXTERNAL ANTENNAS

Article No.	Antenna	MIMO type	Frequency	Radiation angle	Antenna gain
103652	ANT-DIR15-2x2-2.4G-01	2x2	2.4 GHz	15°	18 dBi
103653	ANT-DIR15-2x2-5.0G-01	2x2	5 GHz	15°	18 dBi
103702	ANT-DIR30-2X2-01	2x2	2.4 / 5 GHz	35°	14 dBi
103703	ANT-DIR60-2X2-01	2x2	2.4 / 5 GHz	65°	8 dBi
103704	ANT-DIR90-2X2-01	2x2	2.4 / 5 GHz	90°	6 / 7 dBi
103705	ANT-OMNI-2X2-02	2x2	2.4 / 5 GHz	omni (360°)	4 dBi
103655	ANT-OMNI-1X1-02	1x1	2.4 / 5 GHz	omni (360°)	0 dBi

WiFi accessories - housings / mounting



Wall mounting bracket
Article No 103748



Housing for indoor use
Article No. 103545



Suspended roof
mounting set
Article No. 103547



Protective cover
Article No. 103551

PRODUCT INFORMATION

APPLICATION

Xirrus has designed a wide range of solutions for installing wireless arrays in various environments and for different applications. These covers, housings and mounting kits serve to install and arrange the wireless arrays in a protected, secure and covered way and provide for long-term high performance of the devices.

DESCRIPTION

The housings available for indoor and outdoor use will protect each array from environmental influences – for example solar radiation, rain, atmospheric humidity, low temperatures, heat and coarse contaminants – and will provide protection against accidental or malicious damage.

Flexible solutions are available for mounting arrays to walls, ceilings or at hall roof level.

TECHNICAL SPECIFICATION

	Dimensions	Weight	Additional information
Protective cover	35.6 x 35.6 x 7.6 cm	0.2 kg	for all arrays XR500 up to XR4xxx
Housing for indoor use	60.3 x 60.3 x 14 cm	8.2 kg	lockable
Suspended roof mounting set with mounting bracket & mounting plate	41 x 41 x 152 cm	6.8 kg	
Wall mounting bracket	25.1 x 14 x 7.9 cm	0.7 kg	

VERSIONS

Article No.	Description
on request	Array wall mounting
see price list	Housing for indoor use for XR-520 up to XR-4xxx, lockable
see price list	Suspended mounting kit with protective cover for schools and halls
103547	Suspended roof mounting set with mounting bracket & mounting plate for mounting at double tee beam
see price list	Plastic protective cover for XR-1000

Other accessories available on request.



PRODUCT INFORMATION

APPLICATION

To simplify network access, Xirus offers high-performance switches. These switches provide an appropriate number of Gigabit Ethernet ports and 4 fibre optic ports. They will make it possible to manage the entire network from a single source – either through the cloud or on-premise solution.

DESCRIPTION

- Main features of Xirus switches:
- 24 and 48 port GigE connectivity
 - PoE/PoE+ on every port
 - Stackability up to 8 switches in a single IP stack
 - Advanced security such as AAA with Radius/802.1x, port locking, and MAC locking
 - Simplified cloud management or on-premises management for switches, arrays and APs
 - Reduced IT burden with zero touch provisioning
 - Robust network access for 802.11ac WLAN devices

TECHNICAL SPECIFICATION

Type	XT-5024	XT-5048
Copper ports	24 10/100/100	48 10/100/100
Number of SFP ports	4	4
Layer	2	2
Manageability	yes	yes
PoE	802.3af/802.3at	802.3af/802.3at
PoE Power Budget	370 W (all ports)	779 W (all ports)
Redundant power supply	no	yes, via external RPS

VERSIONS

Article No.	Description	Type	Designation
103740	XT-5024	24-port PoE+ switch	Layer 2, 802.3af/at, 24 GigE ports, 4 SFP/SFP+ ports, stackable
103741	XT-5048	48-port PoE+ switch	Layer 2, 802.3af/at, 48 GigE ports, 4 SFP/SFP+ ports, stackable

WiFi accessories – power supply



XP1-MSI-75



XP2-MSI-95M



XP8-MSI-70M

PRODUCT INFORMATION

APPLICATION

The Xirrus XP Power over Gigabit Ethernet (PoGE) system is used to provide Xirrus WiFi arrays with a simple and cost-effective remote power supply by way of the data cable.

DESCRIPTION

The PoGE system supplies the Xirrus array internally with direct current via the Gigabit Ethernet data interface. As the arrays require more power than other WLAN solutions, use of the PoGE system is imperative and already included in the bundle packages on offer.

ACCESSORIES

PoE adapters for use in racks or cabinet systems are available as accessories.

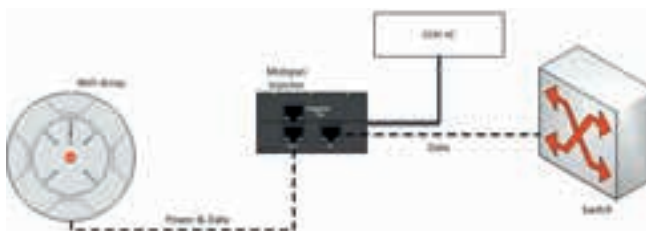

TECHNICAL SPECIFICATION

Model	Generic PoE switch (802.3af)	Generic PoE+ switch (802.3at)	Xirrus XT 802.3af & 802.3af switches	XP1-MSI-20	XP1-MSI-30	XP1-MSI-75	XP1-MSI-75M	XP2-MSI-95M	XP8-MSI-70	XP8-MSI-70M
XR-520	✓	✓	✓	✓	✓		✓	✓		✓
XR-620		✓	✓	✓	✓		✓	✓		✓
XR-630		✓	✓		✓	✓	✓	✓		✓
XR-2226		✓	✓				✓	✓		✓
XR-2236		✓	✓				✓	✓		✓
XR-2426		✓	✓				✓	✓		✓
XR-2436			✓				✓	✓		✓
XR-2000						✓	✓	✓	✓	✓
XR-4000						✓	✓		✓	✓
XR-6000								✓ (2 ports)		
XR-7000								✓ (2 ports)		

VERSIONS

Article No.	Type	Designation
103652	XP1-MSI-30	1 port 30W Power over Gigabit Injector
103724	XP1-MSI-75	1 port 75W Power over Gigabit Injector
103726	XP2-MSI-95M	2 port 95W Power over Gigabit Injector, administrable
103728	XP8-MSI-70M	8 port 70W Power over Gigabit Injector, administrable

Other accessories available on request.

WiFi accessories - Xirrus Management System

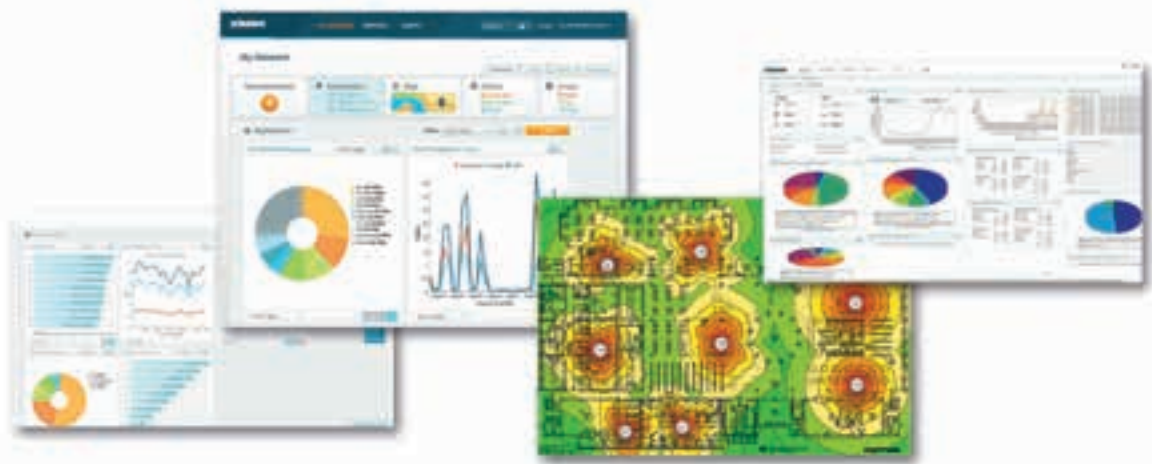

PRODUCT INFORMATION

APPLICATION

The Xirrus Management System (XMS) provides a powerful platform for central management of the WiFi array network. The XMS detects, configures and monitors the array network and can be scaled to an intercontinental system.

Because of the comprehensive opportunities for analysis and evaluation on the management console, the XMS is equally suitable for optimising the wireless network on the basis of equipment type and bandwidth requirements.

For smaller environments the usage of the XMS NextGen cloud solution is recommended, since no additional hardware and software must be installed. Therefore a significant reduction of the operating costs can be achieved. In mid-sized environments is the multi-tenant XMS Enterprise cloud solution a way to achieve cost-savings in infrastructure.

DESCRIPTION

The Xirrus Management System (XMS) is available as a Linux-based appliance or as software for Windows HyperV or VMware solutions. Software licensing depends on the number of integrated access points to be administered.

Main features of the XMS:

- Automatic detection of the WiFi arrays in a network
- Policy-based configuration for the simple setup of one or more arrays
- Consolidated view of arrays, radio cells, security, performance and alarm status
- Numerous statistics on all aspects of arrays and performance
- Central monitoring and classification of external access points and wireless devices
- View of alarms, system logs for error monitoring of the entire network
- Overview and detailed reports on data throughput, security, channel utilisation etc.
- Simultaneous push software upgrades for one or more arrays
- Database based platform, supports large networks, spread over several locations
- System monitoring via integrated heat map and geo-localization
- Guest access management

VERSIONS

Article No.	Type	Description / Remark
	XMS-9000-VM	Type VMWare. Please order a sufficient number of radio licenses separately (see: XMS-9000-xx)
	XMS-9000-HV	Type Windows HyperV. Please order a sufficient number of radio licenses separately (see: XMS-9000-xx)
	XMS-9000-xx	Number of radio licenses. Available are 20, 50, 100, 200, 500, 1000, 2000, 5000, 10000, and unlimited
	XMS-9000-CL-x	XMS Enterprise cloud solution. 1-year, 3-year or 5-year license (x) available
	XMS-9500-CL-x	XMS NextGen cloud solution for smaller environments. 1-year, 3-year or 5-year license (x) available

CAT TV Panel / CAT TV Balun

Active system, up to 862 MHz
for the distribution of CATV signals

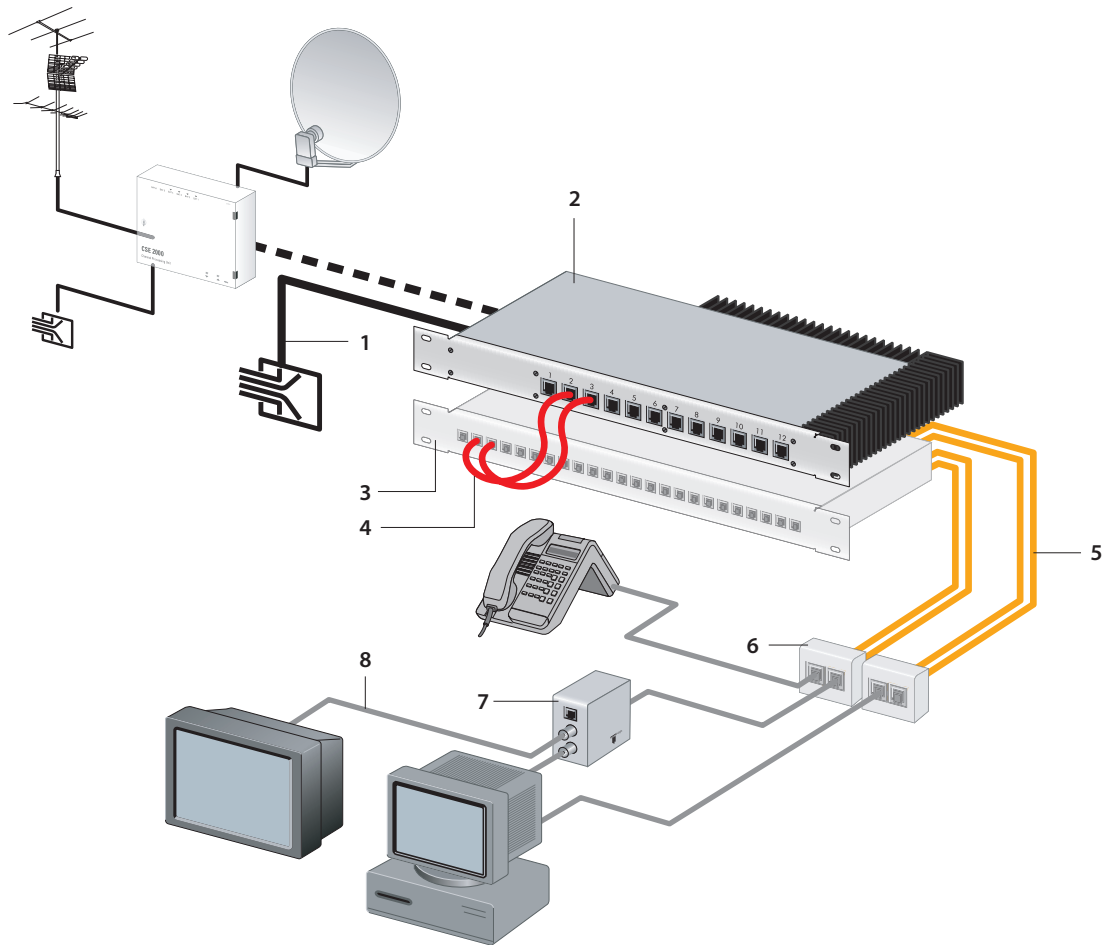

- 1 Input: unbalanced, 75 ohm, coax
 - a) directly from broadband network (building entry point, BEP)
 - b) after signal processing at head-end
- 2 CAT TV Panel
- 3 Patch panel, 100 ohm
e.g. Datwyler patch panel
- 4 Patch cord with RJ45 plug, shielded
- 5 Data cable, Category 7 or 7_A, shielded, with low attenuation,
e.g. Datwyler CU 7150 Multimedia or CU 7702 (AWG 22)
- 6 Faceplate/data outlet with shielded jacks
- 7 CAT TV Balun (balancer/unbalancer)
- 8 TV connection cable, 75 ohm, coax

CAT TV Panel

Active distribution panel, up to 862 MHz,
for the distribution of CATV signals



CAT TV Panel



Power adapter for CAT TV Panel

PRODUCT INFORMATION

APPLICATION

For the distribution of CATV signals over structured premises cabling.

DESCRIPTION

The CAT TV Panel is an active distribution panel that converts CATV signals (coaxial / 75 ohm) into a balanced signal (symmetrical / 100 ohm) for transmission over structured premises cabling. The CAT TV Balun* which is connected close to the TV / Radio reconverts the signal to coaxial / 75 ohm. It is possible to simultaneously distribute TV and telephone services over one and the same cable.

Digital video broadcast programs over cable (DVB-C) can be also transmitted without problems. For reception a DVB-C receiver is necessary that is integrated in the end-user device or a set top box must be connected. Some satellite programs can also be transmitted if they are transformed into a frequency channel of the CATV frequency range.

TECHNICAL SPECIFICATION

Transmission of CATV signals over shielded class E/E_A and F/F_A cabling.

Connections on the rear of the panel:

Frequency range:	45 (85) - 862 MHz
Frequency range backward:	without or (optional) with backward channel 5 - 65 MHz
Input signal level:	70-83 dBμV, maximal equalization: 12dB
Integrated impedance transducer:	75 / 100 ohm
Link length:	10 - 90 m, adjustable for LAN, dependent on the type of data cable
Input 1:	F-type jack, 75 ohm (on the rear side)
Input 2:	Interface input, 15 pin D-type
Measurement connection:	1x F-type jack, 75 ohm, for data / backward channel
Output:	12x RJ45, 100 ohm
Housing:	metal, 19"/1U
Power supply:	from an external power supply (adapter included)
EMC:	in accordance with EN 50083-8 and EN 55022 Part B

Article No.	Description
1411770	CAT TV Panel set, 12 ports, with power adapter without backward channel
417824	Power adapter for CAT TV Panel
1411764	Passive diplex module for retrofitting for backward channel 5 - 65 MHz

*A separate CAT TV Balun is required for each link where an end device is to be connected.

CAT TV Balun

Active balun, up to 862 MHz,
for the distribution of CATV signals



CAT TV Balun

PRODUCT INFORMATION

APPLICATION	For the distribution of CATV signals over structured premises cabling.														
DESCRIPTION	<p>The CAT TV-Balun reconverts the balanced signal (100 ohm) that is transmitted from the CAT TV Panel over the structured cabling system into an unbalanced (75 ohm) coaxial output for the connection of an end device (e.g. television, radio).</p> <p>One CAT TV Balun is required for each link to an end device.</p> <p>A 3-position switch provides adjustment for cable length, attenuation and equalization.</p>														
TECHNICAL SPECIFICATION	<table border="0"> <tr> <td>Frequency range:</td> <td>45 (85) - 862 MHz without (or with) backward channel</td> </tr> <tr> <td>Frequency range backward:</td> <td>without or (optional) with backward channel 5 - 65 MHz</td> </tr> <tr> <td>Input signal level:</td> <td>75 / 100 ohm</td> </tr> <tr> <td>Input:</td> <td>1x RJ45 jack, 100 ohm</td> </tr> <tr> <td>HF output 1:</td> <td>1x IEC plug, 75 ohm, for TV / radio</td> </tr> <tr> <td>HF output 2:</td> <td>Version without backward channel: 1x IEC jack, 75 ohm, for radio Version with backward channel: 1x F-type jack, 75 ohm, for data</td> </tr> <tr> <td>Output signal level:</td> <td>60 - 77 dBμV</td> </tr> </table>	Frequency range:	45 (85) - 862 MHz without (or with) backward channel	Frequency range backward:	without or (optional) with backward channel 5 - 65 MHz	Input signal level:	75 / 100 ohm	Input:	1x RJ45 jack, 100 ohm	HF output 1:	1x IEC plug, 75 ohm, for TV / radio	HF output 2:	Version without backward channel: 1x IEC jack, 75 ohm, for radio Version with backward channel: 1x F-type jack, 75 ohm, for data	Output signal level:	60 - 77 dB μ V
Frequency range:	45 (85) - 862 MHz without (or with) backward channel														
Frequency range backward:	without or (optional) with backward channel 5 - 65 MHz														
Input signal level:	75 / 100 ohm														
Input:	1x RJ45 jack, 100 ohm														
HF output 1:	1x IEC plug, 75 ohm, for TV / radio														
HF output 2:	Version without backward channel: 1x IEC jack, 75 ohm, for radio Version with backward channel: 1x F-type jack, 75 ohm, for data														
Output signal level:	60 - 77 dB μ V														

Article No.	Description
1411767	CAT TV Balun without backward channel
1411769	CAT TV Balun with backward channel 5 - 65 MHz

Adapter RJ45-IEC

Multimedia adapter

for transmission of broadband signals up to 862 MHz without a Balun



Multimedia adapter RJ45-IEC

PRODUCT INFORMATION

APPLICATION

For the distribution of CATV signals over structured premises cabling.

DESCRIPTION

Adapter for transmission of digital TV broadband signals (DVB-C) in high quality LANs without a Balun.

A high quality shielded twisted pair cable generally allows transmission of two different transmission modes: even mode and odd mode. For data transmission in data cables only the odd mode is used. The adapter RJ45-IEC uses for transmission the even mode. The physical transmission is like that in a coaxial cable. The adapter provides the current IEC plug as physical interface.

Odd mode: Current data transmission mode (10GBase-T, 1000Base-T, etc.) when using symmetrical copper data cable. One conductor of a pair of wires is used as "forward conductor", the other one as "backward conductor". The shield carries no current – it only serves as shielding for protection against EMC.

Even mode: Quasi-coaxial transmission mode. Both conductors of a pair of wires are used as "forward conductors". The shield serves as "backward conductor" – just like the shield of a coaxial cable.

TECHNICAL SPECIFICATION

Frequency range: 5 - 862 MHz
 Attenuation: < 0.5 dB
 Return loss: > 12 dB
 Interface: RJ45 [plug] / IEC [male]
 Pin assignment RJ45: PIN [7/8]
 Colour: orange
 Weight: 10 g

Dimensions:



NOTE

The use of the adapter is recommended when the following data cables are deployed:
 CU 7150 S/FTP AWG22 Cat.7_A
 CU 7120 S/FTP AWG23 Cat.7_A

Article No.	Description	PU
417917	Adapter RJ45-IEC	2 pcs.

GENERAL INFORMATION

Testing and measuring procedures of copper data cables

This overview indicates to what degree and how consequent all Datwyler copper data cables are tested for their quality.

Testing of all manufactured cables*

DC resistance of copper wire

Voltage indication

Capacitance

Testing content

Wire resistance, loop resistance, resistance difference

Wire to wire and wire to screen

Mutual capacitances, capacitive couplings, capacitive earth unbalance

* Each length is tested.

Point by point testing (per production unit)

Transmission characteristics

Material features

Testing content

Impedance, Return Loss, Attenuation, Near End Cross Talk (NEXT), ACR-F

Break stretching of the copper wire, tensile strength of the insulation, stretching of the insulation, tensile strength of the sheath, stretching of the sheath

These values / features are tested with samples.

Type specific tests and measuring

Transmission characteristics

Mechanical and physical product features

Tests to avoid damage during installation

Environmental qualities

Insulation Resistance

Screen performance

Testing content

All electrical parameters demanded in the appropriate standards, Permanent Link and Channel measurements

Shrinking of the insulation, wrapping of the insulation after alteration, cold resistance of the insulation, tensile strength and break stretching of the cable sheath after alteration, pressure sensitivity at high temperatures, cold bending test of the cable, heat resistance, atmospheric humidity test for cables, temperature test, and UV test

Cable crushing, wire crushing, shock resistance of the cable, repeated cable bending and tensile strength test

Acid emission, smoke emission, burning test for individual cable (fire behavior) and burning test for cable bundle (vertical burn test)

Each wire against each wire and against cable screen

Transmission impedance of the cable, Coupling Attenuation

Type specific tests are carried out during the development stage and in case of changing the cable construction

Quality Control

Imprint

Content

It is ensured by an identification of each cable (production batch number) that the measured values can be recovered at any time.

Example: CU 7002 4P FRNC/LS0H 887149

Wire design & Twisting procedures of copper data cables

Copper wire design

FULL PE WIRE

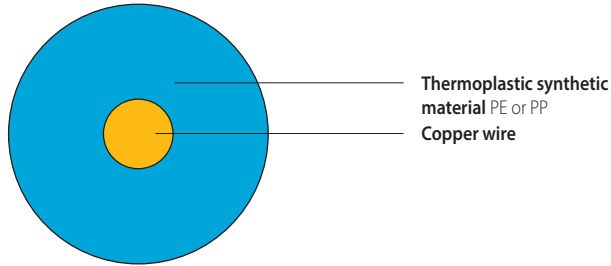

FOAM WIRE WITH PE SKIN

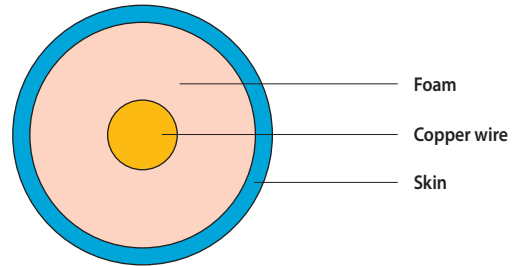

SKIN-FOAM-SKIN WIRE

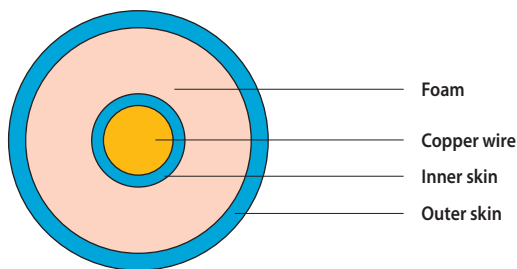

Twisting procedures of Datwyler data cables

TWISTED PAIR

TP (Twisted Pair)



STAR QUAD TWISTING

Star quad

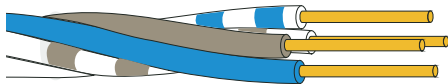

PATENTED STABILIZING ELEMENT

A very important aspect of high performance data cables is their sturdy mechanical design. The mechanical stress during the installation must not be underestimated: it can have negative effects on the transmission characteristics.

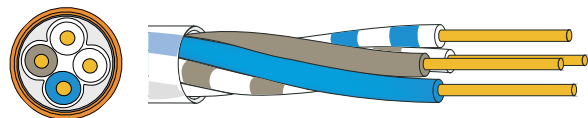









Datwyler maximises the electrical performance of some of its high-quality data cables with an additional stabilizing element. This special construction is protected by the European patent 0567757 B1.

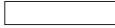







Colour code of copper data cables

Wire insulation colours of Datwyler CU twisted pair data cables (in accordance with IEC 60189)









CU 6002 4P, 7060 4P, 7080 4P, 7002 4P, 7120 4P

Twisted Pair	Wire a	Wire b
Pair 1		
Pair 2		
Pair 3		
Pair 4		

CU 7150 4P, 7702 4P









Twisted Pair	Wire a	Wire b
Pair 1		
Pair 2		
Pair 3		
Pair 4		

CU 502 4P, 602 4P, 662 4P, 5002 4P, 5502 4P, 6702 4P (radial marks)

Twisted Pair	Wire a	Wire b
Pair 1		
Pair 2		
Pair 3		
Pair 4		

Wire Colour Code for twisted pair CU data cables (Flexible cables)

CU 5502 flex 4P, 7702 flex 4P, 7150 flex 4P

Twisted Pair	Wire a	Wire b
Pair 1		
Pair 2		
Pair 3		
Pair 4		

AWG = American Wire Gauge.

This number is derived from the number of drawing dies that are needed to manufacture a certain cross section.

The larger the AWG number, the smaller the wire diameter.

AWG	Diameter of solid conductor, minimum [mm] <small>(according to UL 444 as of 11 July 2008)</small>	Cross-sectional area of stranded conductor, minimum [mm ²] <small>(according to UL 444 as of 11 July 2008)</small>
18	1.013	0.807
19	0.866*	0.641
20	0.772*	0.509
21	0.688*	0.404
22	0.610*	0.318
23	0.546*	0.254
24	0.485*	0.201
25	0.432*	0.159
26	0.384*	0.126
27	0.358	0.100
28	0.318	0.079

*) Minimum acceptable diameter (0.95 x nominal) of a solid conductor of this size

AWG number for typical copper data cable constructions

AWG	Category & cable type
AWG 26	Cat.7 flexible cable, shielded (S/FTP, stranded wire)
AWG 24	Cat.6 flexible cable, unshielded (UTP, stranded wire)
AWG 24	Cat.6 data cable, unshielded (UTP)
AWG 23	Cat.7 data cable, shielded (S/FTP)
AWG 22	Cat.7 data cable, shielded (S/FTP)
	due to its low attenuation especially suited for:
	- 10-gigabit Ethernet with big reserves to the limit values
	- CATV transmissions up to 862 MHz
	- Power or Ethernet (PoE...)

Installation guidelines for copper data cables

Quality assurance on the construction site

- Please check the following points:
 - Did the delivery include the right cable type?
 - Does the product show any damage caused by transit?
 - Is a temporary store organised for the cables on the construction site?
 - Do the cable and connection components comply with the requested Category / Class?
 - Do you have shielded connection components for the shielded cable?

Storage

- If you do not intend to install the data cables immediately after delivery they should be stored in a place that offers protection from mechanical damage and temperature influences.
- The store should be dry and protected from environmental influences.
- Stored cables should be kept in their original packaging until they are to be installed.

Regulations, standards and guidelines

- In general, always follow the regulations and guidelines specific to the country in which the materials are being installed. Always follow the manufacturer's guidelines for the cables and connecting hardware.

Open installation, wall openings, cable trays

- Copper data cables cannot be installed like power cables and should be installed distant from other cables.
- When these requirements are fulfilled, copper data cables can be laid in open trays in all areas (cable trays, riser zone, communications rooms, etc.).
- The cables can be held in place using cable ties or similar equipment, but the cables should not be crushed when using these devices. Please see the passage 'Pressure on data cables'.
- Before installation, the edges of wall apertures should be smooth and rounded off. This will prevent sheath damages and the need to remove and replace cables at a later date.
- The bending radius of the cables should not fall below the value stipulated by the manufacturer.
- The radius of the cable channels must correspond to the specified bending radius of the cables.

Lubricants for cable moving

- Never use milking grease or other oiliferous and fatty substances.
- For cable pulling the following lubricants may be used:
 - Yellow lubricant (Wire-Pulling, Lubricant of Klein tools; 51000)
 - Talcum

Pulling force of data cables

- You can find the permitted pulling force per cable on the Datwyler copper cable data sheets.

Installation guidelines for copper data cables

Cable pulling

- Always pull cables directly from the drum or box. When using reels always use suitable equipment that will ensure free rotation of the reel.
- Never pull the cables over the flange of the reel (risk of twisting).
- Rewind unused cable and fix the end firmly.
- Use all wires for retracting.
Please fix the open wires with insulating tape between the moving equipment and the cable sheath.

Bending radius

- The bending radius of copper data cables should always be bigger than 8x the overall diameter of the cable during installation (in accordance with EN50173) - unless otherwise specified by the cable manufacturer.
- Always check the data sheets for exact specifications.
If two different bending radii are listed, this means:
 - bend radius with the higher value: during installation
 - bend radius with the lower value: after installation

Pressure on data cables

- Avoid any pressure on copper data cables! Crushing that effects the wires can have a negative effect on the transmission characteristics of the cable.
The most frequent reasons of crushing are improperly fixed cables, crossing of cables and mechanical stress.

Heat influence

- Foamed wires are sensitive to direct heat influence.
Never expose Datwyler data cables to direct heat sources.
Never use a hot air gun or a gas burner (e. g. when using heat shrinking tubing).

Cable laying

- Lay data cables in channels / trays distant from power cables; always use a bridge when crossing 90°. That avoids negative EMC influence.
Please see the passage «Regulations, standards and guidelines».

Cable termination in patch panels

- Always follow the connecting hardware manuals.
- Avoid storing 'reserve loops' at the patch panel.
- For cables with pairs in metal foil (S/FTP, PiMF) the foil screen should be brought as close as possible to the point of termination.
- If the cable provides an additional stabilizing element and a metal foil these must also be brought as close as possible to the point of termination.

Standards for copper data cables

Areas of application of the standards

Cabling standardisation comes from two main organisations: ISO/IEC defines standards that are applicable world wide.

In Europe, an additional organisation called CENELEC defines specifications which support safety guidelines on behalf of the European Union and the EFTA. Thus, the European Standard EN is the principal reference standard in most European countries.

The cabling system standards are defined in the standards ISO/IEC 11801 and EN 50173-1.

These standards also describe the basic requirements for data cables. Due to these requirements the different cable specifications were worked out and defined in the following documents.

Standards for symmetrical data cables

In Europe, the following international standards are for information only.

INTERNATIONAL STANDARDS

ISO/IEC 11801
is applicable worldwide

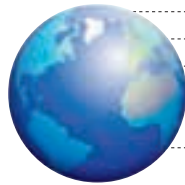

ISO/IEC 11801	Information technology and application-independent wiring systems
IEC 61156	Multiconductor and symmetrical pair-/star quad twisted cable for the digital communication transmission
	IEC 61156-1: Subject basic specification
	IEC 61156-2: Frame specification for floor cable
	IEC 61156-3: Frame specification for equipment connection cable
	IEC 61156-4: Frame specification for distribution cables
	IEC 61156-5: Frame specification for data cables up to 1000 MHz
	IEC 61156-6: Frame specification for equipment connection cable up to 1000 MHz
	IEC 61156-7: Frame specification for Backbone cable up to 1200 MHz

These documents specify the copper data cables of the categories 3, 5, 6, 6_A, 7 and 7_A (upcoming: 8) for patch and connecting cables, for installation cables and backbone cables.

EUROPEAN STANDARDS



EN 50173
is the European standard

50173 series 2011	Information technology: Generic cabling
	Part 1: General requirements Part 4: Homes
	Part 2: Office premises Part 5: Data centres
	Part 3: Industrial premises Part 6: Distributed building services
50174 series	Information technology: Cabling installation
	Part 1: Specification and quality assurance
	Part 2: Installation planning and practices inside buildings
	Part 3: Installation planning and practices outside buildings
EN 50310	Application of equipotential bonding and earthing in buildings with information technology equipment
EN 50288	Multiconductor metallic data and control cables for an analogue and digital transmission
EN 50288-1	Subject basic specifications
EN 50288-2-1	Frame specification for shielded cables for the horizontal and backbone area up to 100 MHz (Cat.5)
EN 50288-2-2	Frame specification for shielded equipment and connecting cables up to 100 MHz (Cat.5)
EN 50288-3-1	Frame specification for unshielded cables for horizontal and backbone area up to 100 MHz (Cat.5)
EN 50288-3-2	Frame specification for unshielded equipment and connecting cables up to 100 MHz (Cat.5)
EN 50288-4-1	Frame specification for shielded cables for horizontal and backbone area up to 600 MHz (Cat.7)
EN 50288-4-2	Frame specification for shielded equipment and connecting cables up to 600 MHz (Cat.7)
EN 50288-5-1	Frame specification for shielded cables for horizontal and backbone area up to 250 MHz (Cat.6)
EN 50288-5-2	Frame specification for shielded equipment and connecting cables up to 250 MHz (Cat.6)
EN 50288-6-1	Frame specification for unshielded cables for horizontal and backbone area up to 250 MHz (Cat.6)
EN 50288-6-2	Frame specification for unshielded equipment and connecting cables up to 250 MHz (Cat.6)
EN 50288-9-1	Frame specification for shielded cables for horizontal and backbone area up to 1000 MHz (Cat.7 _A)
EN 50288-10-1	Frame specification for shielded cables for horizontal and backbone area up to 500 MHz (Cat.6 _A)
EN 55022	EMC standards for office surroundings

Transmission (Channel) requirements for application classes - copper

A comparison of selected electrical requirements
for different frequencies and different transmission classes
according to ISO/IEC

Frequency [MHz]		Class D	Class E	Class E _A	Class F	Class F _A
1	Attenuation	4.0	4.0	4.0	4.0	4.0
	NEXT	63.3	65.0	65.0	65.0	65.0
	ACR	59.3	61.0	61.0	61.0	61.0
	Return Loss	17.0	19.0	19.0	19.0	19.0
	PS-ACR-F	x	x	67.0	67.0	67.0
16	Attenuation	9.1	8.3	8.1	8.1	8.0
	NEXT	43.6	53.2	53.2	65.0	65.0
	ACR	34.5	44.9	45.1	56.9	57.0
	Return Loss	17.0	18.0	18.0	18.0	18.0
	PS-ACR-F	x	x			
100	Attenuation	24.0	21.7	20.8	20.8	20.3
	NEXT	30.1	39.9	39.9	62.9	65.0
	ACR	6.1	18.2	19.2	42.1	46.1
	Return Loss	10.0	12.0	12.0	12.0	12.0
	PS-ACR-F	x	x	60.0	60.0	67.0
250	Attenuation	x	35.9	33.8	33.8	32.5
	NEXT	x	33.1	33.1	56.9	59.1
	ACR	x	-2.8	-0.7	23.1	26.6
	Return Loss	x	8.0	8.0	8.0	8.0
	PS-ACR-F	x	x	54.0	54.0	67.0
500	Attenuation	x	x	49.3	49.3	46.7
	NEXT	x	x	27.9	52.4	53.6
	ACR	x	x	-21.4	3.1	6.9
	Return Loss	x	x	8.0	8.0	8.0
	PS-ACR-F	x	x	49.5	49.5	64.5
600	Attenuation	x	x	x	54.6	51.4
	NEXT	x	x	x	51.2	51.1
	ACR	x	x	x	-3.4	-0.7
	Return Loss	x	x	x	8.0	8.0
	PS-ACR-F	x	x	x	x	x
1.000	Attenuation	x	x	x	x	67.6
	NEXT	x	x	x	x	47.9
	ACR	x	x	x	x	-19.7
	Return Loss	x	x	x	x	8.0
	PS-ACR-F	x	x	x	x	60.0

NOTE concerning Alien Crosstalk (the influence by signals of electromagnetic interference from parallel laid other copper cables):
All Category 7 copper data cables fulfil "per design" the standard requirements for Alien Crosstalk parameters.
In the European standard EN 50173-1:2007 three different grades for the electromagnetic compatibility are defined (MICE table).
The best grade E3 can be achieved only with shielded data cables.

**Datwyler has recommended high-grade shielded Cat.7 and Cat.7_A copper data cables (PiMF) for many years
and has therefore - in view of the increasing requirements - provided its customers with long-term investment protection.**

GENERAL INFORMATION

**Copper data cable design description
in accordance with ISO/IEC 11801**

Cable design description

X X / X X X	balanced element	TP = twisted pair or star quad
	shielding element	U = unshielded F = foil
overall shielding		F = foil shielded S = braid shielded SF = braid and foil shielded

- Examples**
- SF/UTP = overall braid and foil shielded cable / with unshielded balanced elements
 - S/FTP = overall braid shielded cable / with foil shielded balanced elements
 - PiMF = Pairs in metal foil (xx/FTP)

U/UTP

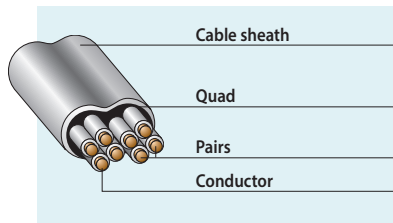
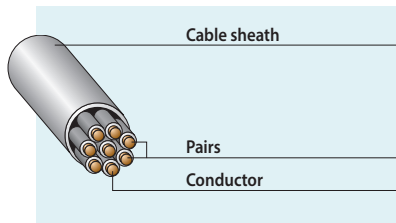

F/UTP

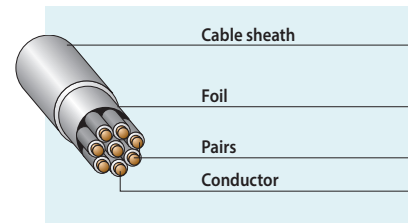

U/FTP

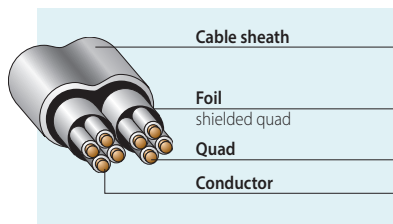
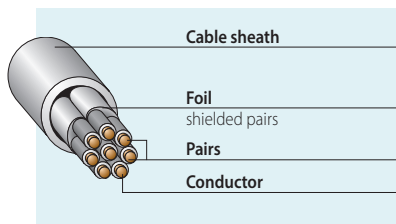

SF/UTP

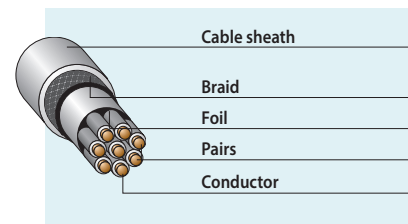

S/FTP (PiMF with overall braid shielding = best shielding performance)

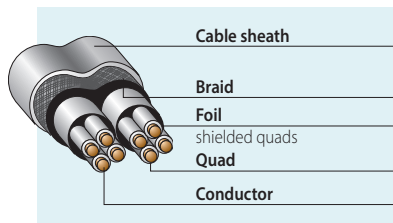
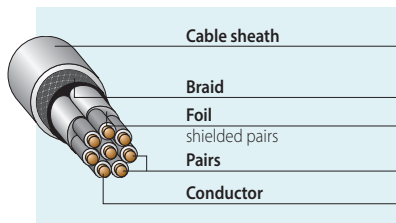

Low attenuation

The data cable has a decisive influence on the attenuation of a data connection (Link), consisting of a patch panel, a data cable and an data outlet.

Data cables with a low attenuation permit cable lengths in excess of 90 m in accordance with the requirements of the chosen application.

Furthermore, the low attenuation offers additional safety, particularly regarding future applications.

Minimised transfer impedance due to foil and braid shielding

The combination of foil and braid shielding results in a low transfer impedance. Coupled interferences can therefore be better discharged via the shielding and over a large frequency band.

As a side-effect, an increased mechanical stabilisation of the cable construction can be achieved.

Constant balance of pairs due to stabilizing element (CU 6702 4P)

The additional stabilizing element results in an additional stabilisation of the wires within the pairs. Thus, the cable provides a very sturdy mechanical design with improved lateral crush resistance, and it also enables smaller bending radii.

A further advantage is - besides a higher stress resistance during installation - an easier compliance with the electrical values at the point of termination.

Advantages of high-grade copper data cables

Insensitivity against external electrical and magnetic influences

The electromagnetic field of an unshielded copper data cable is not limited to the immediate area between the wires (see figure 1).

The electrical and magnetic fields close to an installed data cable are rarely uniform or constant. For an unshielded cable these fields directly effect the electrical transmission characteristics of the twisted pairs (see figure 3).

In a shielded data cable (with foil and braid shielding of high quality) the electromagnetic field is contained within the overall shield. Therefore, major external influences have minimal effect on the transmission performance of the cable (figure 2).

The impedance path is not influenced by the surrounding.

The results are stable transmission characteristics (figure 4), usually indicated by excellent Return Loss (RL) values for installed cables.

Twisted Pair, unshielded

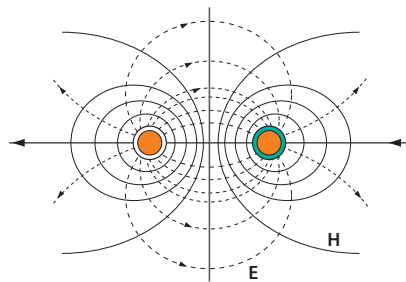

E = electric field
H = magnetic field

Figure 1

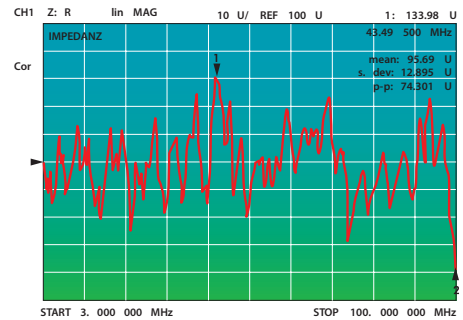
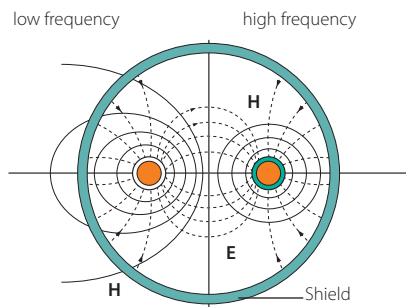

Figure 3

Twisted Pair, shielded



E = electric field
H = magnetic field

Figure 2

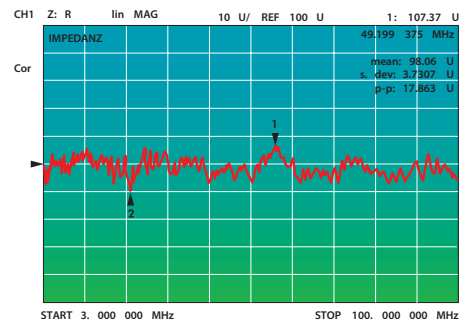

Figure 4

Mechanical & environmental requirements for fibre optic cables

Mechanical / environmental requirements for FO cables with Single-mode fibres

Test type	Test method	Test criterion
Tensile performance	IEC 60794-1-2-E1	Fibre elongation
Crush resistance	IEC 60794-1-2-E3	Fibre attenuation
Impact	IEC 60794-1-2-E4	No damage to the sheath and cable elements
Repeated bending	IEC 60794-1-2-E6	No fibre break
Bend	IEC 60794-1-2-E11	Fibre attenuation
Torsion	IEC 60794-1-2-E7	Fibre attenuation
Water penetration	IEC 60794-1-2-F5	Water penetration
Temperature cycling	IEC 60794-1-2-F1	Fibre attenuation

Mechanical / environmental requirements for FO cables with Multimode fibres

Test type	Test method	Test criterion
Tensile performance	IEC 60794-1-2-E1	Fibre elongation
Crush resistance	IEC 60794-1-2-E3	Fibre attenuation
Impact	IEC 60794-1-2-E4	No damage to the sheath and cable elements
Repeated bending	IEC 60794-1-2-E6	No fibre break
Bend	IEC 60794-1-2-E11	Fibre attenuation
Torsion	IEC 60794-1-2-E7	Fibre attenuation
Water penetration	IEC 60794-1-2-F5	Water penetration
Temperature cycling	IEC 60794-1-2-F1	Fibre attenuation

Identification / designation code for Datwyler fibre optic cables according to DIN EN 60794-1-1 Bbl 1 (VDE 0888-100-1 Bbl 1) : 2012-11

1	2	3	4	5	6	7
						<p>Optical quality / transmission properties</p> <p>A Attenuation coefficient (dB/km) and bandwidth (MHz x 100 m) at wavelength about 650 nm</p> <p>B Attenuation coefficient (dB/km) and bandwidth (MHz x 100 m) at wavelength about 850 nm</p> <p>F Attenuation coefficient (dB/km) and bandwidth (MHz x km) or dispersion (ps/(nm * km)) at wavelength about 1300 nm or 1310 nm</p> <p>H Attenuation coefficient (dB/km) and dispersion (ps/(nm * km)) at wavelength about 1550 nm</p> <p>Optical fibre</p> <p>E Single-mode fibre (glass core/glass cladding)</p> <p>G Multimode graded index fibre (glass core/glass cladding)</p> <p>GK Multimode graded index fibre (glass core/polymer cladding)</p> <p>K Multimode step index fibre (glass core/polymer cladding)</p> <p>S Multimode step index fibre (polymer core/polymer cladding)</p> <p>P Multimode step index fibre (glass core/glass cladding)</p> <p>Fibre dimensions: Core or field diameter in µm (nominal par) Cladding diameter in µm (nominal par)</p> <p>Number of optical fibres / number of loose tubes x number of fibres per tube</p> <p>Sheath or secondary coating</p> <p>H made of halogen-free material</p> <p>M made of lead</p> <p>Y made of PVC</p> <p>2Y made of PE</p> <p>4Y made of PA</p> <p>5Y made of PTFE</p> <p>6Y made of FEP</p> <p>7Y made of ETFE</p> <p>9Y made of PP</p> <p>10Y made of PVDF</p> <p>11Y made of TPE-U (PUR)</p> <p>12Y made of TPE-E</p> <p>Construction details (from left to right = from inside to outside in the cable)</p> <p>B Armouring</p> <p>1B Armouring with one layer steel band</p> <p>2B Armouring with two layers steel band</p> <p>F Cable core filled</p> <p>0F Cable core filled with solids</p> <p>Q Dry swelling materials in cable core</p> <p>(L) Plain, overlapping aluminium foil</p> <p>(Rxx) Armouring made of round wires (xx = wire diameter in mm)</p> <p>S Metal stranding element</p> <p>(SR) Overlapping steel grooved band</p> <p>(ZN) Non-metallic strain-relief elements</p> <p>(ZS) Metallic strain-relief/supporting elements in cable core</p> <p>Type</p> <p>B Loose tube, unfilled</p> <p>D Loose tube, filled</p> <p>DA Loose tube made of aluminium, filled</p> <p>DC Loose tube made of copper, filled</p> <p>DS Loose tube made of steel, filled</p> <p>H Single-fibre loose tube, unfilled</p> <p>V Tight buffer</p> <p>W Single-fibre loose tube, filled</p> <p>Product / Application</p> <p>A Outdoor cable</p> <p>AT Outdoor cable, divisible</p> <p>B Loose tube, unfilled</p> <p>D Loose tube, filled</p> <p>F Fibre</p> <p>H Single-fibre loose tube, unfilled</p> <p>J Indoor cable</p> <p>U Universal cable (indoor & outdoor)</p> <p>V Tight buffer</p> <p>W Single-fibre loose tube, filled</p>

Copper

Fibre Optics

Cabinets & Racks

Data Centre

Wireless

Multimedia

General Information

Type designation for Datwyler fibre optic cables

Area of application	Number of fibres	Fibre type	Cable design	Armouring	Sheath	Maximum tubes	Additional properties	VDE 0888 equivalent type
								I-V(ZN)H I-M(ZN)H I-V(ZN)HH U-DQ(ZN)BH U-DQS(ZN)BH A-DQ(ZN)B2Y A-DQ(ZN)(SR)B2Y A-D2Y A-DQ(ZN)2Y
							Indoor: Simplex Single-fibre Mini Zip-cord 2-fibre mini data cable Zip-cord 2-fibre data cable Duplex 2 fibres FTTH Fibre to the home BO Break-out Universal: (Standard) General purpose Safety System Circuit Integrity for 30 minutes Easy Blow Injection installation Combi FO cable with copper wires Outdoor: HP High mechanical performance BL Basic mechanical performance Micro Micro cables for jetting in microducts S-Micro High density micro cables for jetting in microducts	
						Number		
					T			Thermoplastic (PE)
					FR/LSOH			Flame retardant, Low smoke zero halogen
					LSOH			Low smoke zero halogen
				K				Aramid yarns
				W				Corrugated steel
				GG				Glas strands
			Z					Central loose tube cable
			wb					Cable with water blocking performance
		E9						Single-mode E9/125
		G50						Multimode G50/125
		G62.5						Multimode G62.5/125
	Number							
FO Indoor								
FO Universal								
FO Outdoor								

Copper

Fibre Optics

Cabinets & Racks

Data Centre

Wireless

Multimedia

General Information

Optical fibre protection & tube construction

There are four different types of fibre optic tube construction - according to the different types of secondary coating that is added to the optical fibres:

- Tight buffer
- Semi tight buffer
- Mini bundle
- Loose tube

Tight buffer

The fibre is tightly jacketed with a thermoplastic oversheath.

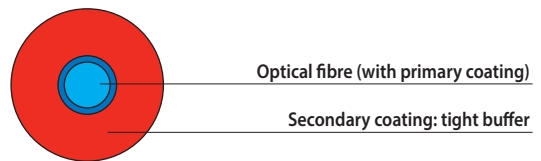

Semi tight buffer

The fibre is loosely jacketed in a tube of a polymer material. The spare room between the fibre and the loose tube is only a few hundredths of a millimeter. The overall diameter of the semi tight buffer is identical with the diameter of the tight buffer.

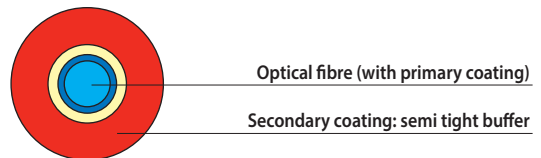

The advantages of the semi tight buffering compared with the tight buffering are:

- the tube can be easily stripped
- minimal effect of microbending

Micro loose tube

2 to 24 optical fibres are loosely encapsulated. The secondary protection consist of one layer of termoplastic material. The interstices inside the tube are filled with gel. The overall diameter is 1.45 mm for 12 fibres and 1.95 mm for 24 fibres.

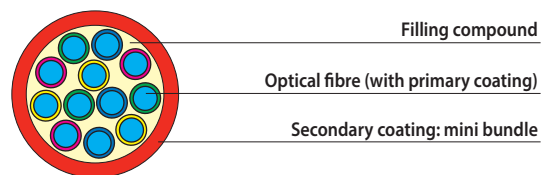

Loose tube

2 to 24 primary coated optical fibers are loosely encapsulated. The tube consist of one or two layers of the same or different materials. The interstices inside the tube are filled with gel. The overall diameter is 2-4 mm, depending on fibre count.

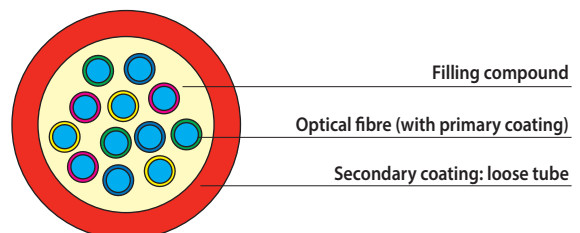

Fibre / tube colour codes & sheath colours

In order to differentiate between the tubes in the FO cables and the optical fibres in a loose tube, the tubes and fibres (more precisely: the primary coating) are given different colours.



Fibre colour code (in accordance with IEC 60304)

(up to 12 fibres)







Fibre no.	colour	
1		red
2		green
3		blue
4		yellow
5		white
6		grey
7		brown
8		violet
9		turquoise
10		black
11		orange
12		pink

Fibre colour code with ring signature (Datwyler)







(up to 24 fibres)

Fibre no.	colour	
13		red/black
14		green/black
15		blue/black
16		yellow/black
17		white/black
18		grey/black
19		brown/black
20		violet/black
21		turquoise/black
22		transparent/black
23		orange/black
24		pink/black

Tube colour code

Tube type	Colour		RAL No.	Fibre types
1st tube		red	3020	all types
2nd tube		green	6018	all types
add. tubes		white	9016	E9/125
		light green	6019	G50/125
		blue	5015	G62/125
dummy elements		black	9005	

Sheath colours

Cable type	Colour	
FO Outdoor cable		black with orange longitudinal stripe
FO Universal cable		green
FO Indoor cable		Single-mode G.652 + G.657 yellow (green)
		Multimode G50 (OM2) orange
		Multimode G50 (OM3) turquoise
		Multimode G50 (OM4) heather violet
		Multimode G62.5 (OM1) grey

GENERAL INFORMATION

Opening of cable sheaths of Datwyler fibre optic cables

Instruction manual

Opening of the cable sheath of fibre optic (FO) cables

Instruction manual

Opening of the cable sheath of type ZwbKWT cable

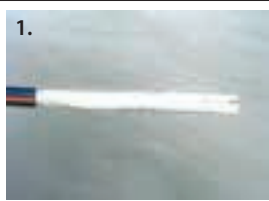

1. Attach a radial cut with a cable stripping knife, approx. 15 cm from one cable end.

Remove the short end by attaching a longitudinal cut.



1. Cut the cable sheath radially, approx. 15 cm from one cable end and from the mark of the required length. (Scratch the corrugated steel tape!) Break the steel tape at those points with care.



2. Lay open the ripcords.



2. Heat the cable end with a gas burner or with an industrial blow-dryer. Remove the heated end carefully (glove!).



3. Fix the ripcord to a screwdriver with a knot (8-loop).



3. Lay open the ripcord. Heat the cable sheath part you want to remove. Grip the ripcord with a screwdriver.



4. Open the cable sheath by pulling the ripcords (vertical to the cable) up to the required length.

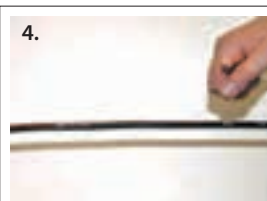

4. Grip the ripcord and pull it up to the required length.



5. Carefully remove the cable sheath. Cut back the sheath, glass armour, ripcords and supporting elements.



5. Carefully remove the cable sheath and the supporting elements.

ACR (Attenuation to Crosstalk Ratio)

The distance between the wanted signal and the interfering signal (ACR) is an important factor for the transmission quality. To ensure a faultless transmission, the interfering signal caused by the crosstalk attenuation must be smaller by a certain factor. This corresponds to the difference between the near end crosstalk attenuation (NEXT) and the attenuation of the link.
 $ACR [dB] = NEXT [dB] - a [dB]$; (a = attenuation)

ACR-F

A calculation that normalizes the results of a FEXT measurement, because it takes attenuation into account. It is derived by subtracting the attenuation of the interfering pair from the far end crosstalk (FEXT) that it has caused in the interfered pair.

Alien Crosstalk

Alien crosstalk (AXT) is electromagnetic noise that can occur in a cable that runs alongside one or more other signal-carrying cables. The term "alien" arises from the fact that this form of crosstalk occurs between different cables in a group or bundle, rather than between individual wires or circuits within a single cable.

Attenuation (signal attenuation, conductor attenuation)

The attenuation depends on the conductor resistance R' and the mutual capacitance C' .
The attenuation rises roughly to 50 MHz with the root of the frequency and increases linearly with the length.

Conductor Resistance (resistance per unit length R')

The resistance per unit length R' includes the losses in the metallic conductors.
The conductor dimensions, the conductor material and the temperature determine the DC resistance R_0 .
Due to the skin effect the conductor resistance increases with frequency.
It behaves linearly with cable length.

Coupling Attenuation

This is the sum of the unsymmetrical attenuation of cable pairs and the shielding effectiveness/attenuation.

Technical terms used in data cable technology

Decibel [dB]

Decibel indicates the relation between the voltage of received signal (U_2) and transmitted signal (U_1). The result is a factor [dB]. The relation is defined:
 U_2/U_1 [dB] = $20 \log_{10} (U_2/U_1)$

U_2/U_1 [dB]	Received signal [%]	U_2/U_1 [dB]	Received signal [%]
0.0	100.0	4.0	63
0.1	98.8	20.0	10
0.2	97.7	40.0	1
0.9	90.1	60.0	0.1
1.0	89.3	80.0	0.01
2.0	79.4	100.0	0.001

De-embedded

The de-embedded testing method for connecting hardware and components provides combinations with all defined quality classes for the RJ45 connectors. The integrated parts are real category 6 which provides the possibility to create open "mix & match" cabling systems without compatibility or test restrictions for the used patch cords, test adapters or active networking devices.

Dielectrical Constant (DK)

The Dielectrical constant is a material constant of the dielectric. The relative permittivity says how much bigger the capacity of the condenser becomes if instead of air the insulant is used as a dielectric. If the dielectrical constant is multiplied by the DK of the empty room, then the result is the DK of the dielectric.

Distributed Inductance L'

The distributed inductance consists of several parts. The outer inductance is determined by line geometry and the magnetic material qualities. It is frequency-independent. Since mainly non-ferromagnetic metals are used as conductor, it is also independent of the current intensity.

The inner inductance can be explained by the current flow and the magnetic fields connected with that in the conductor. Due to the current superseding, L' disappears at high frequencies. For shielded, symmetrical cables the frequency dependent cover inductance as well as the inductance produced by proximity effect must be taken into account.

Distributed Leakage G'

It describes the insulation losses, the dielectric losses as well as the Corona losses between the wires.

Instead of the often strongly frequency dependent parameter G' the factor Q (Q = theta) indicates the loss factor.

The value of the loss factor depends on the insulant, the insulation design, the frequency and the temperature.

Q should be as small as possible and generally constant.

DMD

Differential Mode Delay. DMD measurement: A single laser light pulse excites a few modes equally within a multimode fibre (MMF) cable. These modes (or light pathways) then follow two or more different paths. These paths may be of different lengths and have different transmission delays as the light travels through the cable. With DMD, a distinct pulse propagating down the cable no longer remains a distinct pulse or, in extreme cases, can become two independent pulses. Strings of pulses tend to interfere with each other, making it difficult to recover data in a reliable fashion.

Lasers function at the baud rates and longer distances required for Gigabit Ethernet: The IEEE 802.3z Gigabit Ethernet Task Force has identified the DMD condition that occurs in certain circumstances with particular combinations of lasers and MMF cable. The resulting characteristics create an additional element of "jitter" that limits the reach of Gigabit Ethernet over MMF cable

Earth Unbalance

The measurement of the difference in the electrical performance of the individual wires of a pair to earth and to the screen. It corresponds to the difference between the capacitance of wire A to the screen and the capacitance of wire B to the screen. It influences the transmission characteristics of the cable.

EMC (Electro Magnetic Compatibility)

The ability for an electrical device to not influence other devices with its electromagnetic field and also to work satisfactorily within the electromagnetic fields of other devices.

FRNC, FR/LS0H or FRNC/LS0H

FR	= flame retardant
NC	= non corrosive - means no corrosive effect in the event of fire
LS	= low smoke - means low smoke emission in the event of fire
0H, ØH or ZH	= no halogen, zero halogen

Halogen-free coating material

A halogen is a salt creator. Chlorine, bromine, fluorine and astat are listed in the periodic table of elements. Cables with a PVC (polyvinyl chloride) sheath are flame retardant (see > PVC). Halogen-free sheath materials don't contain any halogens! Therefore no corrosive gases are emitted from the cable in the event of a fire, the smoke emission is reduced to a minimum and fire propagation is avoided.

Technical terms used in data cable technology

Impedance Z_0 (wave impedance, characteristic wave impedance)

The impedance of a wire represents the ratio of the voltage wave progressing in a direction to the current wave. Common values are 100, 120 and 150 ohm. For higher frequencies the impedance is the root over the ratio between the distributed inductance L' and the mutual capacitance C' . It is important that the impedance of the cable corresponds with the input/output impedance of the attached end device.

minEMBc

The minEMBc bandwidth (Minimum Calculated Effective Modal Bandwidth) is the newest, most flexible and most accurate method to determine the minimum laser bandwidth (high data rate capability of a fibre). Its results are more comprehensive than those of DMD mask measurement methods. Both the minEMBc and the DMD measurement techniques were developed as part of the IEEE 802.3ae standard. The minEMBc method is described in TIA/EIA 455-220A and IEC 60793-1-49 Ed. 2.0. Today, it is the only scaleable measurement technique recognised by international standards. Just as over-filled launch (OFL) bandwidth testing has demonstrated conformance for legacy applications and specifications, laser bandwidth test data provided by Datwyler MMF suppliers can be used to certify the requirements demanded by bandwidth hungry applications used today and in the future.

Mutual Capacitance (Distributed capacitance C')

This is the function of the line geometry (line ÷ line ÷ screen) and the dielectric constant (DK) of the insulation. As long as the DK of the insulation is constant with frequency, the distributed capacitance is almost frequency-independent. The mutual capacitance increases linearly with the cable length.

Network Theory

Every homogeneous line is defined by four parameters which refer to a unit length and are generally frequency-dependant. These are the resistance per unit length R' (conductor resistance) in ohm, the distributed inductance L' in Henry, the distributed capacitance C' (mutual capacitance) in Farad and the distributed leakage G' in Siemens.

NEXT, FEXT crosstalk attenuation

An interfering signal is induced by the field produced by a transmitted signal in one twisted pair on to a neighbouring twisted pair. The crosstalk is length-independent and becomes bigger with an increasing frequency. The difference between the desired signal and the induced signal on the neighbouring twisted pair is described as crosstalk attenuation and is indicated in dB. We distinguish between NEXT = Near End Cross Talk and FEXT = Far End Cross Talk.

NVP (Nominal Phase Velocity of Propagation)

Corresponds to the reciprocal value of the speed of transmission a sinusoidal wave relative to the speed of light. It is indicated in % c (c = speed of light). The NVP is primarily determined by the relative dielectricity constant of the wire coating. NVP is an approximate average value for the cable.

OFL (Overfilled Launch Bandwidth)

Overfilled launch bandwidth (OFL BW) is a familiar metric that is now understood to correlate only with LED-based multimode applications (typical: up to 100 Mbit/s). It is important to understand that OFL BW is never suitable for predicting laser performance.

PE

Polyethylene (PE) is a halogen-free synthetic material that burns easily. By adding additives, PE can be made flame retardant and get low smoke characteristics.

PiMF

Pair in metal foil - description for a STP cable. Each pair is shielded with a metal foil of its own.

PoE / PoE Plus

Power over Ethernet is the transmission of DC voltage - maximum 15 W (PoE) or 30 W (PoE Plus) - over twisted pair data cables and data networks. The transmission of DC voltage takes place parallel to the transmission of Ethernet protocols in one and the same cable by using the spare wires.

PSACR-F

PSACR-F is the Power Sum Attenuation to Crosstalk Ratio. As with all crosstalk measurements (including ACR) there is also a Power Sum ELFEXT (PSELFEXT). These are calculated values expected for multi-pair simultaneous full duplex transmissions

PVC

Polyvinylchloride (PVC) is a synthetic material containing halogen (unlike Polyethylene). Halogens (salt creators) are chlorine, bromine, fluorine, iodine and astat. By using additives like chlorine and fluorine PVC can be made flame-retardant and more resistant against outer influences. PVC jacketed cables are flame-retardant. Synthetic materials containing halogen, form highly-poisonous gases in case of fire. When mixed with water these gases form harmful corrosive acids.

Technical terms used in data cable technology

Return Loss (RL)

The transmission performance of a data cable differs along the length of the cable. The reasons are tolerances caused by different dielectric constants for the insulation and unavoidable production differences along the cable's length. Although they are so small this discontinuity in the cable construction causes reflections of voltage waves and current waves.

Results of these reflections are:

Reflection coefficient	=	Relation between transmitted (regular) and received (reflected) voltage wave or current wave at the discontinuity points
Reflow factor	=	Sum of all reflections having an effect on the beginning of the line (transmitted wave). This factor indicates the usefulness of a line
Return Loss (RL)	=	Logarithm of the reciprocal value of the reflow factor

A high Return Loss can only be reached by the highest production precision and by extremely little production tolerances (high homogeneity) and therefore is a quality characteristic.

RML (Restricted Mode Launch Bandwidth, RML BW)

RML Bandwidth test procedure is standardized in both TIA/EIA 455-204 (FOTP 204) and IEC 60793-1-41. RML BW restricts an overfilled launch through a 23.5 micron patchcord, which in turn measures the bandwidth capability of a fibre's low and intermediate mode groups. The resulting bandwidth measurement predicts laser performance for intermediate bandwidth systems (up to 850 MHz.km) in the same way – and with the same level of accuracy – as OFL BW predicts LED performance in legacy-bandwidth systems.

Skin Effect

The higher the signal frequency, the closer the current flows to the outside of the cable. At high frequencies the current flows through the very outer molecules of the wire.

Transfer Impedance (Coupling resistance)

The Transfer Impedance is a main parameter for the quality of the screen and is frequency dependant. The relation is between the voltage drop along the screen on the disturbed lengthways side (outer) to the interfering current on the other side (inside) of the screen. The coupling resistance is determined by the construction of the screen, the skin effect and the capacitive coupling.

ARTICLE NUMBERS

Article No.	Page	Article No.	Page	Article No.	Page	Article No.	Page	Article No.	Page
190617	215	191466	32	192645	223	309026	101	309123	286
190618	209	191467	32	192678	209	309027	101	309124	286
190621	211	191693	227	192689	235	309029	101	309180	108, 109
190650	229	191698	229	192693	241	309031	101	309181	108, 109
190651	225	191700	215	192697	225	309046	82	309182	108, 109
190658	237	191701	217	192712	207	309047	84	309183	108, 109
190661	221	191702	237	192713	207	309048	283	309184	108, 109
190662	221	191703	237	192714	209	309049	283	309185	108, 109
190692	217	191704	237	192715	209	309050	283	309188	165
190696	225	191705	237	192933	201	309051	283	309190	138
190699	227	191706	239	192967	207	309052	283	309191	138
190700	227	191710	209	192968	207	309053	283	309192	138
190709	227	191753	207	192969	207	309054	277	309193	138
190719	211	191755	207	192970	207	309055	277	309194	138
190747	223	191782	225	193314	207	309056	277	309195	138
190752	233	191796	211	193337	207	309057	277	309196	137
190753	217	191797	199	193340	241	309058	277	309197	137
190754	215	191798	199	193341	197	309059	277	309198	137
190764	225	191799	199	193360	207	309060	277	309199	137
190792	211	191800	202	193398	229	309061	277	309200	137
190822	275	191801	202	193409	203	309062	277	309201	137
190823	275	191806	235	193410	203	309063	277	309202	138
190825	278	191813	239	193433	236	309064	277	309203	137
190826	278	191814	239	193434	236	309065	277	309204	137
190827	278	191825	215	193435	236	309066	277	309205	137
190828	282	191838	225	193447	211	309067	277	309206	137
190829	282	191851	211	193448	211	309068	277	309207	137
190830	282	191858	239	193449	211	309069	277	309208	137
190831	282	191859	239	193450	211	309070	280	309209	137
190832	282	191860	239	193454	213	309071	280	309210	138
190833	282	191867	211	193455	213	309072	280	309211	141
190834	282	191877	197	193456	213	309073	280	309212	141
190835	275	191878	197	193457	213	309074	280	309213	135, 136, 149,
190905	141	191923	42	193460	236	309075	280		155
190915	141	192009	26	193465	198	309076	280	309214	276
190916	141	192068	62	193468	198	309077	280	309215	276
190937	134	192085	197	24...		309084	285	309216	276
190938	134	192086	197	240129	76	309085	285	309217	279
190939	134	192087	197	240130	78	309086	285	309218	279
190940	134	192088	197	240131	78	309087	285	309219	279
190958	139	192089	197	240132	78	309088	285	309220	279
190965	139	192090	201	240133	78	309089	285	309230	283
190977	135, 136, 149, 154, 155	192091	201	240134	78	309090	285	309231	283
190984	150	192092	201	240135	78	309091	285	309239	109
190985	150	192093	201	240136	76	309092	285	309240	108
190986	150	192094	201	240137	76	309093	285	309242	164
191188	231	192095	201	240139	76	309094	285	309243	164
191190	231	192096	201	240140	76	309095	285	309248	108, 109
191191	213	192097	201	240141	76	309096	285	309249	109
191197	229	192098	201	240142	76	309097	285	309250	108, 133, 140, 165
191235	237	192099	201	240148	76	309098	285	309262	205
191251	207	192119	213	240149	76	309103	82	309263	205
191252	207	192121	223	240150	78	309104	84	309264	205
191256	231	192126	197	240151	78	309105	86	309265	205
191259	231	192131	239	30...		309106	86	309266	205
191270	225	192139	201	309001	102	309107	285	309267	205
191277	215	192146	199	309002	102	309108	285	309268	205
191278	209	192147	199	309003	102	309109	285	309290	205
191292	231	192148	215	309005	102	309110	285	309291	205
191294	199	192149	241	309006	102	309111	286	309292	205
191349	237	192150	241	309007	102	309113	286	309293	205
191350	237	192156	217	309009	102	309115	286	309294	205
191410	64	192158	239	309011	102	309116	286	309295	205
191453	50	192167	223	309021	101	309117	286	309301	102
191454	48	192170	209	309022	101	309118	286	309302	102
191455	50	192610	223	309023	101	309120	286	309303	102
191456	48	192625	241	309025	101	309121	286	309305	102
		192626	231			309122	286		

Article No.	Page	Article No.	Page	Article No.	Page	Article No.	Page	Article No.	Page
309306	102			415216	267	415627	320	417356	265
309307	102	41...		415217	267	415628	320	417357	265
309309	102	414492	257	415218	267	415629	320	417358	265
309310	102	414493	257	415219	267	416601	242	417374	262
309321	101	414494	257	415220	267	416890	274	417377	262
309322	101	414495	257	415221	267	416891	274	417378	262
309323	101	414711	250, 253	415222	267	416892	274	417379	262
309325	101	414712	250, 253	415223	267	416893	274	417396	271
309326	101	414713	250, 253	415224	267	416900	271	417400	178
309327	101	414714	250, 253	415225	267	416901	271	417401	178
309329	101	414715	250, 253	415226	267	416902	271	417402	178
309331	101	414716	250, 253	415227	267	416903	271	417404	178
309428	205	414717	250, 253	415228	267	416904	270	417444	149
309470	205	414718	250, 253	415229	267	416905	270	417445	118
309495	308	414719	250, 253	415230	267	416906	270	417446	118, 149
309602	308	414720	250, 253	415231	267	416907	265	417447	149, 155
309608	308	415001	242	415232	267	416908	265	417448	149, 155
309609	308	415002	242	415233	267	416909	265	417450	155
		415003	242	415234	267	416951	262	417480	149
38...		415004	242	415235	267	416952	262	417483	180
385700	114	415005	242	415236	267	416953	262	417484	180
		415006	242	415238	267	416954	262	417485	180, 181
40...		415007	242	415239	267	416955	262	417486	129
400098	144	415008	242	415240	267	416956	262, 264	417487	181
400102	104	415009	242	415241	262	416957	262, 264	417488	181
400103	104	415010	242	415242	267	416958	262, 264	417489	180
400105	104, 173	415011	242	415243	267	416959	263	417490	180
400120	93	415012	242	415244	267	416960	263	417500	163
400121	93	415013	242	415245	261	416961	264	417501	163
400122	93	415014	242	415247	262	416962	264	417503	163
400123	93	415015	242	415248	262	416963	264	417510	162
400125	93	415016	242	415249	262	416964	260	417520	159, 160
400300	169, 272, 287	415017	242	415250	269	416965	263	417521	158
400305	175	415018	242	415251	269	416966	264	417522	157
400310	103	415019	242	415252	269	416967	262, 264	417530	161
400311	103	415020	242	415253	269	416968	262, 264	417531	175
400312	103	415021	242	415254	269	416975	260	417550	262
401200	284	415023	243	415255	269	416976	264	417559	262
401201	284	415024	243	415256	269	416977	263	417560	264
401202	284	415025	243	415257	269	416979	270	417561	264
401203	284	415028	242	415258	269	416980	265	417562	264
401211	284	415081	243	415259	269	416981	265	417824	333
401212	284	415082	243	415260	269	416988	270, 271	417854	256
401213	284	415083	243	415261	269	416989	270	417857	262, 264
401214	284	415084	243	415262	269	416994	262	417858	262, 264
401215	284	415085	243	415263	269	416997	271	417868	262
401220	284	415086	243	415264	269	417131	242	417882	264
401221	284	415087	243	415265	269	417132	242	417906	92
401222	284	415088	243	415266	269	417212	265	417917	335
401230	284	415089	243	415267	269	417213	242	417976	110
401231	284	415090	243	415268	269	417214	242	417979	110
401232	284	415091	243	415269	269	417215	242	417980	111
401233	284	415092	243	415270	269	417216	242	417985	107, 111, 128
401234	284	415093	243	415271	269	417217	242	417986	107, 128
401235	284	415094	243	415272	269	417218	242	418000	123
401236	284	415096	242	415273	269	417219	242	418001	123
401237	284	415201	261	415274	269	417220	242	418002	123
401238	284	415203	261	415275	267	417221	242	418003	123
401239	284	415204	261	415276	269	417222	242	418005	122
401240	169, 272, 287	415207	269	415278	269	417223	242	418006	116
401241	169, 272, 287	415208	262	415279	269	417279	262	418010	125, 129, 143, 146, 147, 148, 151, 156
401242	169, 272, 287	415209	264	415280	269	417299	264	418011	143, 144, 146, 147, 148, 151, 156
401243	169, 272, 287	415210	267	415295	267	417350	265	418013	156
401244	169, 272, 287	415211	267	415296	269	417351	265	418014	156
401245	169, 272, 287	415212	267	415298	267	417352	265		
401247	169, 272, 287	415213	267	415299	267	417353	265		
401248	169, 272, 287	415214	267	415308	262	417354	265		
401249	169, 272, 287	415215	267	415310	262	417355	265		

ARTICLE NUMBERS

Article No.	Page	Article No.	Page	Article No.	Page	Article No.	Page	Article No.	Page
418019	143	418525	256	421171	247	421337	247, 249	421515	247, 251
418020	143	418526	256	421172	247	421338	247, 249	421516	247, 251
418021	151	418527	256	421173	247	421339	247, 249	421517	247, 251
418022	151	418528	256	421174	247	421340	247, 249	421518	247, 251
418023	115, 145	418530	256	421175	247	421351	247, 249	421519	247, 251
418025	168	418531	256	421176	247	421352	247, 249	421520	247, 251
418026	167	418532	256	421177	247	421353	247, 249	421531	247, 251
418030	130	418533	256	421178	247	421354	247, 249	421532	247, 251
418031	130	418534	256	421179	247	421355	247, 249	421533	247, 251
418032	130	418535	257	421180	247	421356	247, 249	421534	247, 251
418033	130	418536	256	421181	246	421357	247, 249	421535	247, 251
418034	130	418537	256	421182	246	421358	247, 249	421536	247, 251
418035	129	418538	256	421211	247, 248	421359	247, 249	421537	247, 251
418036	129	418539	256	421212	247, 248	421360	247, 249	421538	247, 251
418037	129	418540	256	421213	247, 248	421371	247, 249	421539	247, 251
418038	129	418541	256	421214	247, 248	421372	247, 249	421540	247, 251
418039	129	418542	256	421215	247, 248	421373	247, 249	421551	247, 251
418054	113	418543	256	421216	247, 248	421374	247, 249	421552	247, 251
418055	119	418544	256	421217	247, 248	421375	247, 249	421553	247, 251
418056	117	418596	257	421218	247, 248	421376	247, 249	421554	247, 251
418060	112	418599	257	421219	247, 248	421377	247, 249	421555	247, 251
418061	106	418650	262	421220	247, 248	421378	247, 249	421556	247, 251
418062	106, 112	418651	264	421231	247, 248	421379	247, 249	421557	247, 251
418063	106, 112	418652	262	421232	247, 248	421380	247, 249	421558	247, 251
418064	106, 112	418654	264	421233	247, 248	421411	247, 250	421559	247, 251
418065	106, 112	418983	271	421234	247, 248	421412	247, 250	421560	247, 251
418066	106, 112	419051	262	421235	247, 248	421413	247, 250	421571	247, 251
418067	106, 112	419052	264	421236	247, 248	421414	247, 250	421572	247, 251
418068	115, 145			421237	247, 248	421415	247, 250	421573	247, 251
418070	120	42...		421238	247, 248	421416	247, 250	421574	247, 251
418071	120	421111	247	421239	247, 248	421417	247, 250	421575	247, 251
418072	120	421112	247	421240	247, 248	421418	247, 250	421576	247, 251
418073	120	421113	247	421251	247, 248	421419	247, 250	421577	247, 251
418098	263	421114	247	421252	247, 248	421420	247, 250	421578	247, 251
418160	273	421115	247	421253	247, 248	421431	247, 250	421579	247, 251
418161	273	421116	247	421254	247, 248	421432	247, 250	421580	247, 251
418162	273	421117	247	421255	247, 248	421433	247, 250	421611	247, 252
418163	273	421118	247	421256	247, 248	421434	247, 250	421612	247, 252
418165	273	421119	247	421257	247, 248	421435	247, 250	421613	247, 252
418166	273	421120	247	421258	247, 248	421436	247, 250	421614	247, 252
418167	273	421121	246	421259	247, 248	421437	247, 250	421615	247, 252
418168	273	421122	246	421260	247, 248	421438	247, 250	421616	247, 252
418200	169, 272, 285, 287	421131	247	421271	247, 248	421439	247, 250	421617	247, 252
418400	179	421132	247	421272	247, 248	421440	247, 250	421618	247, 252
418401	179	421133	247	421273	247, 248	421451	247, 250	421619	247, 252
418402	179	421134	247	421274	247, 248	421452	247, 250	421620	247, 252
418403	179	421135	247	421275	247, 248	421453	247, 250	421631	247, 252
418404	179	421136	247	421276	247, 248	421454	247, 250	421632	247, 252
418506	256	421137	247	421277	247, 248	421455	247, 250	421633	247, 252
418507	256	421138	247	421278	247, 248	421456	247, 250	421634	247, 252
418508	256	421139	247	421279	247, 248	421457	247, 250	421635	247, 252
418509	256	421140	247	421280	247, 248	421458	247, 250	421636	247, 252
418510	256	421141	246	421311	247, 249	421459	247, 250	421637	247, 252
418511	256	421142	246	421312	247, 249	421460	247, 250	421638	247, 252
418512	256	421144	246	421313	247, 249	421471	247, 250	421639	247, 252
418513	256	421145	246	421314	247, 249	421472	247, 250	421640	247, 252
418514	256	421151	247	421315	247, 249	421473	247, 250	421651	247, 252
418515	256	421152	247	421316	247, 249	421474	247, 250	421652	247, 252
418516	256	421153	247	421317	247, 249	421475	247, 250	421653	247, 252
418517	256	421154	247	421318	247, 249	421476	247, 250	421654	247, 252
418518	256	421155	247	421319	247, 249	421477	247, 250	421655	247, 252
418519	256	421156	247	421320	247, 249	421478	247, 250	421656	247, 252
418520	256	421157	247	421331	247, 249	421479	247, 250	421657	247, 252
418521	256	421158	247	421332	247, 249	421480	247, 250	421658	247, 252
418522	256	421159	247	421333	247, 249	421511	247, 251	421659	247, 252
418523	256	421160	247	421334	247, 249	421512	247, 251	421660	247, 252
418524	256	421161	246	421335	247, 249	421513	247, 251	421671	247, 252
		421162	246	421336	247, 249	421514	247, 251	421672	247, 252

Article No.	Page	Article No.	Page	Article No.	Page	Article No.	Page	Article No.	Page
421673	247, 252	422255	248	422419	248, 250	422577	248, 251	423315	249
421674	247, 252	422256	248	422420	248, 250	422578	248, 251	423316	249
421675	247, 252	422257	248	422431	248, 250	422579	248, 251	423317	249
421676	247, 252	422258	248	422432	248, 250	422580	248, 251	423318	249
421677	247, 252	422259	248	422433	248, 250	422611	248, 252	423319	249
421678	247, 252	422260	248	422434	248, 250	422612	248, 252	423320	249
421679	247, 252	422261	246	422435	248, 250	422613	248, 252	423321	246
421680	247, 252	422262	246	422436	248, 250	422614	248, 252	423322	246
421711	247, 253	422271	248	422437	248, 250	422615	248, 252	423331	249
421712	247, 253	422272	248	422438	248, 250	422616	248, 252	423332	249
421713	247, 253	422273	248	422439	248, 250	422617	248, 252	423333	249
421714	247, 253	422274	248	422440	248, 250	422618	248, 252	423334	249
421715	247, 253	422275	248	422451	248, 250	422619	248, 252	423335	249
421716	247, 253	422276	248	422452	248, 250	422620	248, 252	423336	249
421717	247, 253	422277	248	422453	248, 250	422631	248, 252	423337	249
421718	247, 253	422278	248	422454	248, 250	422632	248, 252	423338	249
421719	247, 253	422279	248	422455	248, 250	422633	248, 252	423339	249
421720	247, 253	422280	248	422456	248, 250	422634	248, 252	423340	249
421811	247, 254	422281	246	422457	248, 250	422635	248, 252	423341	246
421812	247, 254	422282	246	422458	248, 250	422636	248, 252	423342	246
421813	247, 254	422311	248, 249	422459	248, 250	422637	248, 252	423348	246
421814	247, 254	422312	248, 249	422460	248, 250	422638	248, 252	423349	246
421815	247, 254	422313	248, 249	422471	248, 250	422639	248, 252	423351	249
421816	247, 254	422314	248, 249	422472	248, 250	422640	248, 252	423352	249
421817	247, 254	422315	248, 249	422473	248, 250	422651	248, 252	423353	249
421818	247, 254	422316	248, 249	422474	248, 250	422652	248, 252	423354	249
421819	247, 254	422317	248, 249	422475	248, 250	422653	248, 252	423355	249
421820	247, 254	422318	248, 249	422476	248, 250	422654	248, 252	423356	249
421911	255	422319	248, 249	422477	248, 250	422655	248, 252	423357	249
421912	255	422320	248, 249	422478	248, 250	422656	248, 252	423358	249
421913	255	422331	248, 249	422479	248, 250	422657	248, 252	423359	249
421914	255	422332	248, 249	422480	248, 250	422658	248, 252	423360	249
421915	255	422333	248, 249	422511	248, 251	422659	248, 252	423361	246
421916	255	422334	248, 249	422512	248, 251	422660	248, 252	423362	246
421917	255	422335	248, 249	422513	248, 251	422671	248, 252	423371	249
421918	255	422336	248, 249	422514	248, 251	422672	248, 252	423372	249
421919	255	422337	248, 249	422515	248, 251	422673	248, 252	423373	249
421920	255	422338	248, 249	422516	248, 251	422674	248, 252	423374	249
422211	248	422339	248, 249	422517	248, 251	422675	248, 252	423375	249
422212	248	422340	248, 249	422518	248, 251	422676	248, 252	423376	249
422213	248	422351	248, 249	422519	248, 251	422677	248, 252	423377	249
422214	248	422352	248, 249	422520	248, 251	422678	248, 252	423378	249
422215	248	422353	248, 249	422531	248, 251	422679	248, 252	423379	249
422216	248	422354	248, 249	422532	248, 251	422680	248, 252	423380	249
422217	248	422355	248, 249	422533	248, 251	422711	248, 253	423381	246
422218	248	422356	248, 249	422534	248, 251	422712	248, 253	423382	246
422219	248	422357	248, 249	422535	248, 251	422713	248, 253	423411	249, 250
422220	248	422358	248, 249	422536	248, 251	422714	248, 253	423412	249, 250
422221	246	422359	248, 249	422537	248, 251	422715	248, 253	423413	249, 250
422222	246	422360	248, 249	422538	248, 251	422716	248, 253	423414	249, 250
422231	248	422371	248, 249	422539	248, 251	422717	248, 253	423415	249, 250
422232	248	422372	248, 249	422540	248, 251	422718	248, 253	423416	249, 250
422233	248	422373	248, 249	422551	248, 251	422719	248, 253	423417	249, 250
422234	248	422374	248, 249	422552	248, 251	422720	248, 253	423418	249, 250
422235	248	422375	248, 249	422553	248, 251	422811	248, 254	423419	249, 250
422236	248	422376	248, 249	422554	248, 251	422812	248, 254	423420	249, 250
422237	248	422377	248, 249	422555	248, 251	422813	248, 254	423431	249, 250
422238	248	422378	248, 249	422556	248, 251	422814	248, 254	423432	249, 250
422239	248	422379	248, 249	422557	248, 251	422815	248, 254	423433	249, 250
422240	248	422380	248, 249	422558	248, 251	422816	248, 254	423434	249, 250
422241	246	422411	248, 250	422559	248, 251	422817	248, 254	423435	249, 250
422242	246	422412	248, 250	422560	248, 251	422818	248, 254	423436	249, 250
422244	246	422413	248, 250	422571	248, 251	422819	248, 254	423437	249, 250
422245	246	422414	248, 250	422572	248, 251	422820	248, 254	423438	249, 250
422251	248	422415	248, 250	422573	248, 251	423311	249	423439	249, 250
422252	248	422416	248, 250	422574	248, 251	423312	249	423440	249, 250
422253	248	422417	248, 250	422575	248, 251	423313	249	423451	249, 250
422254	248	422418	248, 250	422576	248, 251	423314	249	423452	249, 250

ARTICLE NUMBERS

Article No.	Page	Article No.	Page	Article No.	Page	Article No.	Page	Article No.	Page
423453	249, 250	423631	249, 252	424419	250	424559	250, 251	424917	255
423454	249, 250	423632	249, 252	424420	250	424560	250, 251	424918	255
423455	249, 250	423633	249, 252	424421	246	424571	250, 251	424919	255
423456	249, 250	423634	249, 252	424422	246	424572	250, 251	424920	255
423457	249, 250	423635	249, 252	424431	250	424573	250, 251	425511	251
423458	249, 250	423636	249, 252	424432	250	424574	250, 251	425512	251
423459	249, 250	423637	249, 252	424433	250	424575	250, 251	425513	251
423460	249, 250	423638	249, 252	424434	250	424576	250, 251	425514	251
423471	249, 250	423639	249, 252	424435	250	424577	250, 251	425515	251
423472	249, 250	423640	249, 252	424436	250	424578	250, 251	425516	251
423473	249, 250	423651	249, 252	424437	250	424579	250, 251	425517	251
423474	249, 250	423652	249, 252	424438	250	424580	250, 251	425518	251
423475	249, 250	423653	249, 252	424439	250	424611	250, 252	425519	251
423476	249, 250	423654	249, 252	424440	250	424612	250, 252	425520	251
423477	249, 250	423655	249, 252	424441	246	424613	250, 252	425521	246
423478	249, 250	423656	249, 252	424442	246	424614	250, 252	425522	246
423479	249, 250	423657	249, 252	424451	250	424615	250, 252	425531	251
423480	249, 250	423658	249, 252	424452	250	424616	250, 252	425532	251
423511	249, 251	423659	249, 252	424453	250	424617	250, 252	425533	251
423512	249, 251	423660	249, 252	424454	250	424618	250, 252	425534	251
423513	249, 251	423671	249, 252	424455	250	424619	250, 252	425535	251
423514	249, 251	423672	249, 252	424456	250	424620	250, 252	425536	251
423515	249, 251	423673	249, 252	424457	250	424631	250, 252	425537	251
423516	249, 251	423674	249, 252	424458	250	424632	250, 252	425538	251
423517	249, 251	423675	249, 252	424459	250	424633	250, 252	425539	251
423518	249, 251	423676	249, 252	424460	250	424634	250, 252	425540	251
423519	249, 251	423677	249, 252	424461	246	424635	250, 252	425541	246
423520	249, 251	423678	249, 252	424462	246	424636	250, 252	425542	246
423531	249, 251	423679	249, 252	424471	250	424637	250, 252	425551	251
423532	249, 251	423680	249, 252	424472	250	424638	250, 252	425552	251
423533	249, 251	423711	249, 253	424473	250	424639	250, 252	425553	251
423534	249, 251	423712	249, 253	424474	250	424640	250, 252	425554	251
423535	249, 251	423713	249, 253	424475	250	424651	250, 252	425555	251
423536	249, 251	423714	249, 253	424476	250	424652	250, 252	425556	251
423537	249, 251	423715	249, 253	424477	250	424653	250, 252	425557	251
423538	249, 251	423716	249, 253	424478	250	424654	250, 252	425558	251
423539	249, 251	423717	249, 253	424479	250	424655	250, 252	425559	251
423540	249, 251	423718	249, 253	424480	250	424656	250, 252	425560	251
423551	249, 251	423719	249, 253	424481	246	424657	250, 252	425561	246
423552	249, 251	423720	249, 253	424482	246	424658	250, 252	425562	246
423553	249, 251	423811	249, 254	424511	250, 251	424659	250, 252	425571	251
423554	249, 251	423812	249, 254	424512	250, 251	424660	250, 252	425572	251
423555	249, 251	423813	249, 254	424513	250, 251	424671	250, 252	425573	251
423556	249, 251	423814	249, 254	424514	250, 251	424672	250, 252	425574	251
423557	249, 251	423815	249, 254	424515	250, 251	424673	250, 252	425575	251
423558	249, 251	423816	249, 254	424516	250, 251	424674	250, 252	425576	251
423559	249, 251	423817	249, 254	424517	250, 251	424675	250, 252	425577	251
423560	249, 251	423818	249, 254	424518	250, 251	424676	250, 252	425578	251
423571	249, 251	423819	249, 254	424519	250, 251	424677	250, 252	425579	251
423572	249, 251	423820	249, 254	424520	250, 251	424678	250, 252	425580	251
423573	249, 251	423911	255	424531	250, 251	424679	250, 252	425581	246
423574	249, 251	423912	255	424532	250, 251	424680	250, 252	425582	246
423575	249, 251	423913	255	424533	250, 251	424811	250, 254	425611	251, 252
423576	249, 251	423914	255	424534	250, 251	424812	250, 254	425612	251, 252
423577	249, 251	423915	255	424535	250, 251	424813	250, 254	425613	251, 252
423578	249, 251	423916	255	424536	250, 251	424814	250, 254	425614	251, 252
423579	249, 251	423917	255	424537	250, 251	424815	250, 254	425615	251, 252
423580	249, 251	423918	255	424538	250, 251	424816	250, 254	425616	251, 252
423611	249, 252	423919	255	424539	250, 251	424817	250, 254	425617	251, 252
423612	249, 252	423920	255	424540	250, 251	424818	250, 254	425618	251, 252
423613	249, 252	424411	250	424551	250, 251	424819	250, 254	425619	251, 252
423614	249, 252	424412	250	424552	250, 251	424820	250, 254	425620	251, 252
423615	249, 252	424413	250	424553	250, 251	424911	255	425631	251, 252
423616	249, 252	424414	250	424554	250, 251	424912	255	425632	251, 252
423617	249, 252	424415	250	424555	250, 251	424913	255	425633	251, 252
423618	249, 252	424416	250	424556	250, 251	424914	255	425634	251, 252
423619	249, 252	424417	250	424557	250, 251	424915	255	425635	251, 252
423620	249, 252	424418	250	424558	250, 251	424916	255	425636	251, 252

Article No.	Page	Article No.	Page	Article No.	Page	Article No.	Page	Article No.	Page
425637	251, 252	426651	252	428911	255	440044	146	570512	310
425638	251, 252	426652	252	428912	255	440046	153	570513	310
425639	251, 252	426653	252	428913	255	440051	147	570518	310
425640	251, 252	426654	252	428914	255	440055	153	570519	310
425651	251, 252	426655	252	428915	255	440059	153	570520	310
425652	251, 252	426656	252	428916	255			570521	310
425653	251, 252	426657	252	428917	255	47...		570522	310
425654	251, 252	426658	252	428918	255	470038	169, 272, 287	570523	310
425655	251, 252	426659	252	428919	255	470039	169, 272, 287	570525	310
425656	251, 252	426660	252	428920	255	470510	310	570526	310
425657	251, 252	426661	246	428921	246	470511	310	570534	310
425658	251, 252	426662	246	428922	246	470512	310	570535	310
425659	251, 252	426667	252			470513	310	570536	310
425660	251, 252	426671	252	43...		470518	310	570537	310
425671	251, 252	426672	252	431141	247	470519	310	570538	310
425672	251, 252	426673	252	431142	247	470520	310	570539	310
425673	251, 252	426674	252	431143	247	470521	310	570641	312
425674	251, 252	426675	252	431144	247	470522	310	570642	312
425675	251, 252	426676	252	431145	247	470523	310	570643	312
425676	251, 252	426677	252	431146	247	470525	310	570644	312
425677	251, 252	426678	252	431147	247	470526	310	570645	312
425678	251, 252	426679	252	431148	247	470534	310	570646	312
425679	251, 252	426680	252	431149	247	470535	310	570651	312
425680	251, 252	426681	246	431150	247	470536	310	570652	312
425711	251, 253	426682	246	431341	247, 249	470537	310	570653	312
425712	251, 253	427711	253	431342	247, 249	470538	310	570654	312
425713	251, 253	427712	253	431343	247, 249	470539	310	570655	312
425714	251, 253	427713	253	431344	247, 249	470540	291	570656	312
425715	251, 253	427714	253	431345	247, 249	470542	291	570661	312
425716	251, 253	427715	253	431346	247, 249	470543	292	570662	312
425717	251, 253	427716	253	431347	247, 249	470544	293	570663	312
425718	251, 253	427717	253	431348	247, 249	470545	293	570664	312
425719	251, 253	427718	253	431349	247, 249	470546	293	570665	312
425720	251, 253	427719	253	431350	247, 249	470549	291	570666	312
425811	251, 254	427720	253	435060	110	470550	309	570701	318
425812	251, 254	427721	246	435067	110	470551	309	570702	318
425813	251, 254	427722	246	44...		470554	293	570703	318
425814	251, 254	427811	253, 254	440004	107, 166	470555	291, 292	570704	318
425815	251, 254	427812	253, 254	440005	107	470610	296	570705	318
425816	251, 254	427813	253, 254	440006	107	470611	296	570706	318
425817	251, 254	427814	253, 254	440012	127	470612	296	570707	318
425818	251, 254	427815	253, 254	440013	127	470613	296	570708	318
425819	251, 254	427816	253, 254	440015	127	470614	296	570709	318
425820	251, 254	427817	253, 254	440018	166	470615	296	570710	318
426611	252	427818	253, 254	440020	128	470616	296	570711	318
426612	252	427819	253, 254	440027	127	470617	296	570712	318
426613	252	427820	253, 254	440028	127	470618	294	570713	318
426614	252	427911	255	440034	107	470619	294	570714	318
426615	252	427912	255	440035	107	470620	294	570715	318
426616	252	427913	255	440036	107	470621	294	570716	318
426617	252	427914	255	440037	107	470622	294	570717	318
426618	252	427915	255	440038	107	470623	294	570718	318
426619	252	427916	255	440039	107	470624	294	570719	318
426620	252	427917	255	440040	148	470625	294	570720	318
426621	246	427918	255	440041	148	470634	308	570721	318
426622	246	427919	255	440042	146	470635	308	570722	318
426631	252	427920	255	440043	146	470637	308	570723	318
426632	252	428811	254			470642	291	570724	318
426633	252	428812	254			470643	292	570725	318
426634	252	428813	254			470644	293	570726	318
426635	252	428814	254			470645	293	570727	318
426636	252	428815	254			470646	293	570728	318
426637	252	428816	254			470648	291	570729	318
426638	252	428817	254			470649	291	570730	318
426639	252	428818	254					570741	318
426640	252	428819	254			57...		570742	318
426641	246	428820	254			570510	310	570743	318
426642	246	428821	246			570511	310	570744	318
		428822	246						

ARTICLE NUMBERS

Article No.	Page	Article No.	Page	Article No.	Page	Article No.	Page	Article No.	Page
570745	318	570903	316		304, 306, 309	651710	100	652024	97
570746	318	570904	316	571600	302	651711	100	652026	97
570747	318	570905	316	571601	302	651712	100	652027	97
570748	318	570911	316	571602	302	651714	100	652028	97
570749	318	570912	316	571603	302	651716	100	652030	97
570750	318	570913	316	571605	300	651718	100	652053	97
570761	318	570914	316	571606	298	651720	100	652058	97
570762	318	570915	316	571607	298	651721	100	652059	97
570763	318	570921	316	571608	298	651722	100	652060	97
570764	318	570922	316	571609	298	651726	100	652061	97
570765	318	570923	316	571630	306	651728	100	652062	97
570766	318	570924	316	571631	306	651730	100	652064	97
570767	318	570925	316	571632	306	651753	100	652066	97
570768	318	570931	316	571633	306	651758	100	652068	97
570769	318	570932	316	571636	304	651759	100	652070	97
570770	318	570933	316	571637	304	651760	100	652072	97
570781	318	570934	316	571638	304	651761	100	652074	97
570782	318	570935	316	571639	304	651762	100	652076	97
570783	318	570941	316			651764	100	652077	97
570784	318	570942	316	65...		651766	100	652078	97
570785	318	570943	316	651553	100	651768	100	652080	97
570786	318	570944	316	651558	100	651770	100	652103	97
570787	318	570945	316	651559	100	651771	100	652108	97
570788	318	570951	316	651560	100	651772	100	652109	97
570789	318	570952	316	651561	100	651776	100	652110	97
570790	318	570953	316	651562	100	651778	100	652111	97
570801	318	570954	316	651564	100	651780	100	652112	97
570802	318	570955	316	651566	100	651803	100	652114	97
570803	318	571201	314	651568	100	651808	100	652116	97
570804	318	571202	314	651570	100	651809	100	652118	97
570805	318	571203	314	651571	100	651810	100	652120	97
570806	318	571204	314	651572	100	651811	100	652122	97
570807	318	571205	314	651576	100	651812	100	652124	97
570808	318	571206	314	651578	100	651814	100	652126	97
570809	318	571211	314	651580	100	651816	100	652127	97
570810	318	571212	314	651603	100	651818	100	652128	97
570821	318	571213	314	651608	100	651820	100	652130	97
570822	318	571214	314	651609	100	651821	100	652153	97
570823	318	571215	314	651610	100	651822	100	652158	97
570824	318	571216	314	651611	100	651826	100	652159	97
570825	318	571500	302	651612	100	651828	100	652160	97
570826	318	571501	302	651614	100	651830	100	652161	97
570827	318	571502	302	651616	100	651853	100	652162	97
570828	318	571503	302	651618	100	651858	100	652164	97
570829	318	571505	300	651620	100	651859	100	652166	97
570830	318	571506	298	651621	100	651860	100	652168	97
570841	318	571507	298	651622	100	651861	100	652170	97
570842	318	571508	298	651626	100	651862	100	652172	97
570843	318	571509	298	651628	100	651864	100	652174	97
570844	318	571530	306	651630	100	651868	100	652176	97
570845	318	571531	306	651653	100	651870	100	652177	97
570846	318	571532	306	651658	100	651872	100	652178	97
570847	318	571533	306	651659	100	651874	100	652180	97
570848	318	571536	304	651660	100	651876	100	652203	97
570849	318	571537	304	651661	100	651877	100	652208	97
570850	318	571538	304	651662	100	651878	100	652209	97
570861	318	571539	304	651664	100	651880	100	652210	97
570862	318	571550	309	651666	100	652003	97	652211	97
570863	318	571551	309	651668	100	652008	97	652212	97
570864	318	571552	309	651670	100	652009	97	652214	97
570865	318	571556	309	651671	100	652010	97	652216	97
570866	318	571557	309	651672	100	652011	97	652218	97
570867	318	571558	309	651676	100	652012	97	652220	97
570868	318	571560	309	651678	100	652014	97	652222	97
570869	318	571561	309	651680	100	652016	97	652224	97
570870	318	571562	309	651703	100	652018	97	652226	97
570901	316	571595	291, 292	651708	100	652020	97	652227	97
570902	316	571599	298, 300, 302,	651709	100	652022	97	652228	97





Article No.	Page	Article No.	Page	Article No.	Page	Article No.	Page	Article No.	Page
652230	97	653660	96	664020	99	1410597	243		
652753	97	653661	96	664026	99	1410598	243		
652758	97	653662	96	664508	99	1410923	242		
652759	97	653664	96	664510	99	1411063	98		
652760	97	653666	96	664512	99	1411400	320		
652761	97	653668	96	664516	99	1411401	320		
652762	97	653670	96	664520	99	1411404	320		
652764	97	653672	96	664526	99	1411405	320		
652766	97	653674	96			1411480	169, 272,		
652768	97	653676	96	140...			285, 287		
652770	97	653677	96	1400830	110, 127, 128,	1411481	169, 272,		
652772	97	653678	96		133, 142, 171,		285, 287		
652774	97	653680	96		259	1411482	169, 272,		
652776	97	653703	96	1401609	111, 116, 122,		285, 287		
652777	97	653708	96		123, 174	1411604	169, 272,		
652778	97	653709	96	1401624	111, 116, 122,		285, 287		
652780	97	653710	96		123, 173	1411747	133		
653503	96	653711	96	1401628	175	1411748	133		
653508	96	653712	96	1401630	127, 133,	1411749	133		
653509	96	653714	96		171, 259	1411750	133		
653510	96	653716	96	1403700	127, 133, 171	1411764	333		
653511	96	653718	96	1403924	127, 133, 171	1411767	334		
653512	96	653720	96	1404390	259	1411769	334		
653514	96	653722	96	1405304	260	1411770	333		
653516	96	653724	96	1405818	242	1411985	105		
653518	96	653726	96	1406091	242	1412330	105, 114, 176		
653520	96	653727	96	1406098	242	1412762	256		
653522	96	653728	96	1406242	242	1414224	257		
653524	96	653730	96	1406273	171, 259	1414225	257		
653526	96	653753	96	1406274	171, 259	1414227	114, 133		
653527	96	653758	96	1406275	171, 259	1414886	256		
653528	96	653759	96	1406276	171, 259	1414887	257		
653530	96	653760	96	1406403	242	1414888	257		
653553	96	653761	96	1406421	242	1414889	257		
653558	96	653762	96	1406758	242				
653559	96	653764	96	1406768	242	400...			
653560	96	653766	96	1406780	242	4000070	286		
653561	96	653768	96	1406794	242	4000072	285		
653562	96	653770	96	1406935	259	4000075	286		
653564	96	653772	96	1406936	259	4000076	286		
653566	96	653774	96	1407035	242	4000077	286		
653568	96	653776	96	1407120	259	4000078	286		
653570	96	653777	96	1407244	242	4000079	286		
653572	96	653778	96	1407611	259	4000080	286		
653574	96	653780	96	1407658	242	4000081	286		
653576	96	654010	95	1407689	169, 272,	4000082	286		
653577	96	654058	95		285, 287	4000083	286		
653578	96	654060	95	1407718	242	4000084	286		
653580	96	654062	95	1407719	242	4000099	144		
653603	96	654066	95	1407720	242	4000140	293		
653608	96	654158	95	1407777	242				
653609	96	654160	95	1407778	242				
653610	96	654162	95	1407837	259				
653611	96	654166	95	1408502	105, 142				
653612	96	654208	95	1408503	105				
653614	96	654210	95	1408504	105				
653616	96	654212	95	1408505	142				
653618	96	654216	95	1408529	242				
653620	96	654258	95	1408597	242				
653622	96	654260	95	1408723	242				
653624	96	654262	95	1408725	242				
653626	96	654266	95	1409210	105, 176				
653627	96			1409554	105				
653628	96	66...		1409558	152				
653630	96	664008	99	1409559	152, 179				
653653	96	664010	99						
653658	96	664012	99	141...					
653659	96	664016	99	1410596	243				

LOCATIONS

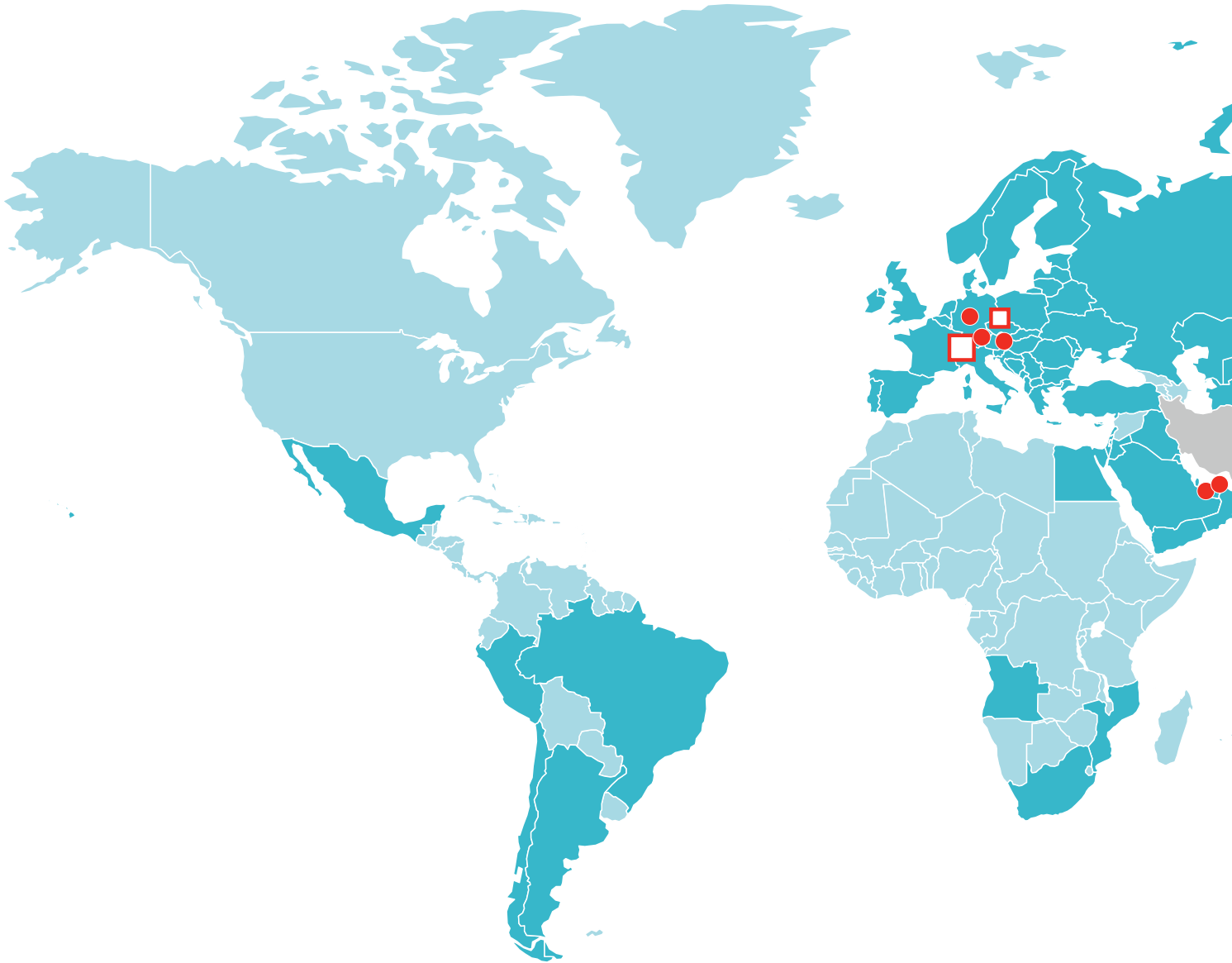
Offices and distribution partners

GLOBAL MARKET COMPETENCE



-  Datwyler Headquarters and Manufacturing Plant
-  Datwyler Manufacturing Plants
-  Datwyler Offices
-  Active Market Presence by Datwyler and its Distribution Partners

Are you searching for a distribution partner in our export markets?
Please visit www.cabling.datwyler.com for details of our partners
or contact our relevant branches.

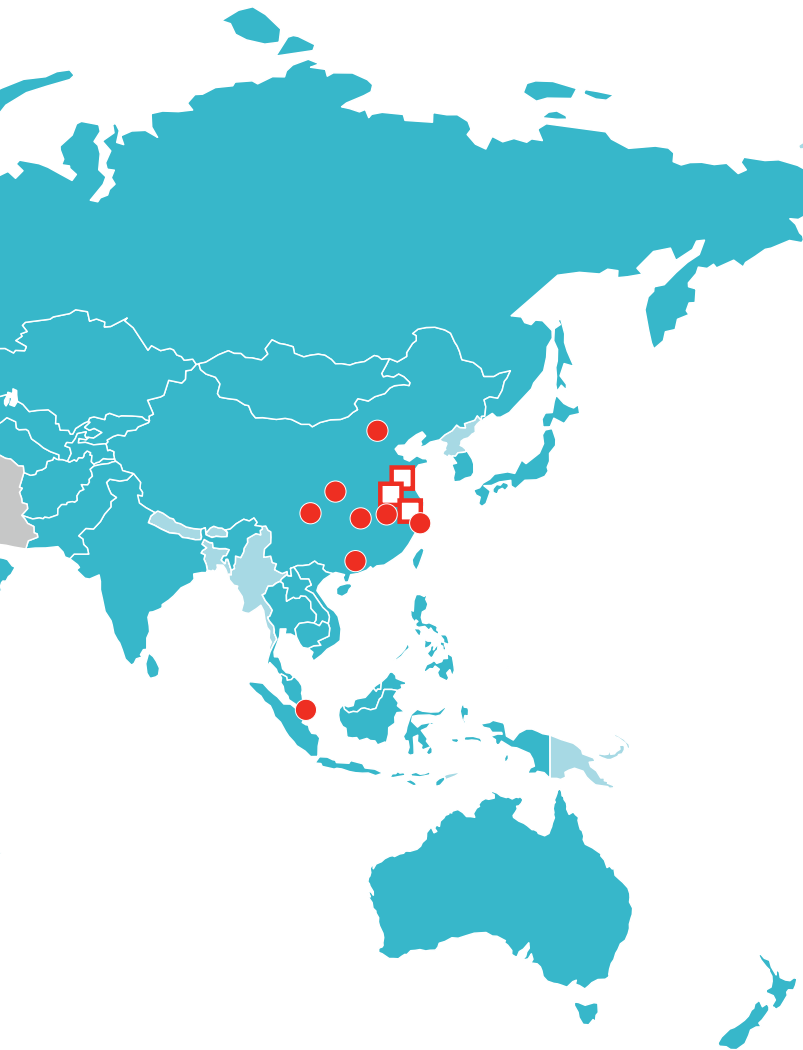

**SWITZERLAND / GREAT BRITAIN /
SOUTHERN EUROPE / LATIN AMERICA**

Dätwyler Cabling Solutions AG
Gotthardstrasse 31, 6460 Altdorf / Switzerland
T +41 41 875-1268, F +41 41 875-1986
info.cabling.ch@datwyler.com

GERMANY / BENELUX / NORTH & EASTERN EUROPE

Dätwyler Cables GmbH
Auf der Roos 4-12, 65795 Hattersheim / Germany
T +49 6190 8880-0, F +49 6190 8880-80
info.cabling.de@datwyler.com

AUSTRIA

Dätwyler Cables GmbH, Office Austria
Tenschertstraße 8, 1230 Wien / Austria
T +43 1 8101641-0, F +43 1 8101641-35
info.cabling.at@datwyler.com

ASIA / OCEANIA

Datwyler (Thelma) Cables+Systems Pte Ltd
29 Tech Park Crescent
638103 Singapore
T +65 68631 166, F +65 68978885
info.cabling.sg@datwyler.com

Datwyler (Suzhou) Cabling Solutions Co., Ltd.
No. 218, East Beijing Road
Taicang Economic Development Zone
Jiangsu Province, 215413 / P. R. China
T +86 512 3306-8066, F +86 512 3306-8049
info.cabling.cn@datwyler.com

MIDDLE EAST

Datwyler Middle East FZE
P.O.Box 263480
Office No. 601, 6th Floor, Jafza 19 View
Jebel Ali Free Zone
Dubai / United Arab Emirates
T +971 4 8810239, F +971 4 8810238
info.cabling.ae@datwyler.com

Datwyler Cabling Solutions LLC
Unit 1004 & 1005, 10th Floor, IB Tower
Business Bay
Dubai / United Arab Emirates
T +971 4 4228129, F +971 4 4228096
info.cabling.ae@datwyler.com



DATWYLER

SWITZERLAND

Dätwyler Cabling Solutions AG

Gotthardstrasse 31
6460 Altdorf
T +41 41 875-1268
F +41 41 875-1986
info.cabling.ch@datwyler.com
www.cabling.datwyler.com

GERMANY

Dätwyler Cables GmbH

Auf der Roos 4-12
65795 Hattersheim
T +49 6190 8880-0
F +49 6190 8880-80
info.cabling.de@datwyler.com
www.cabling.datwyler.com

Dätwyler Cables GmbH

Lilienthalstraße 17
85399 Hallbergmoos
T +49 811 998633-0
F +49 811 998633-30
info.cabling.de@datwyler.com
www.cabling.datwyler.com

AUSTRIA

Dätwyler Cables GmbH Office Austria

Tenschartstraße 8
1230 Wien
T +43 1 8101641-0
F +43 1 8101641-35
info.cabling.at@datwyler.com
www.cabling.datwyler.com

UNITED ARAB EMIRATES

Datwyler Middle East FZE

P.O.Box 263480
Office No. 601, 6th Floor, Jafza 19 View
Jebel Ali Free Zone
Dubai
T +971 4 8810239
F +971 4 8810238
info.cabling.ae@datwyler.com
www.cabling.datwyler.com

Datwyler Cabling Solutions LLC

Unit 1004 & 1005, 10th Floor, IB Tower
Business Bay
Dubai
T +971 4 4228129
F +971 4 4228096
info.cabling.ae@datwyler.com
www.cabling.datwyler.com

CHINA

Datwyler (Suzhou) Cabling Solutions Co., Ltd.

No. 218, East Beijing Road
Taicang Economic Development Zone
Jiangsu Province, 215413
T +86 512 3306-8066
F +86 512 3306-8049
info.cabling.cn@datwyler.com
www.cabling.datwyler.com

Datwyler (Suzhou) Cabling Systems Co. Ltd

Block 31, #15 Dong Fu Road
Suzhou Singapore Industrial Park
Suzhou, 215123
T +86 512 6265-3600
F +86 512 6265-3650
harnessing.cabling.cn@datwyler.com
www.cabling.datwyler.com

SINGAPORE

Datwyler (Thelma) Cables+Systems Pte Ltd

29 Tech Park Crescent
638103 Singapur
T +65 68631166
F +65 68978885
info.cabling.sg@datwyler.com
www.cabling.datwyler.com