

Product catalogue 2023

Fiber optic cables

 **KDP**[®]
WORLD CONNECTING CABLES

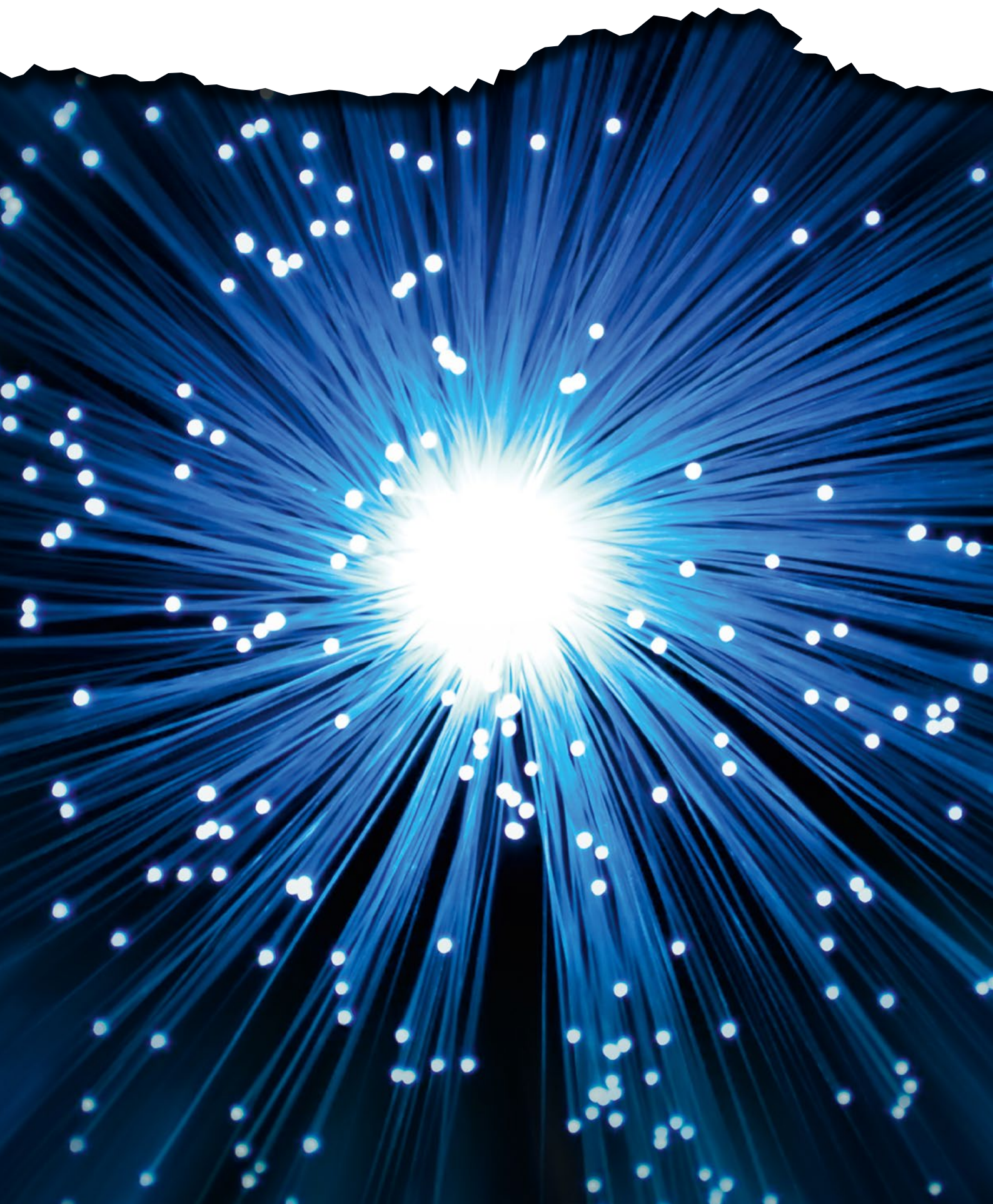

Dear Customers,

since 1910 we have been supplying the cables which help you to solve your problems through communication. Enclosed, please, find a new comprehensive catalogue containing the basic product line of our company.

We tried not only to include the standard products that you probably know very well, but some innovations and brand new products as well. Despite the catalogue is considered as a complete presentation of our production, not all variants can be published and included.

For some special products, please, contact our Sales Department that will provide you with any information requested. Let us advice you of the fact that all cable parameters in this catalogue are for information only.

All rights reserved.



Lenka Mádlová
Head of Commercial Department – Member of board

Summary

1. TIGHT BUFFERED CABLES

SIMPLEX	12
DUPLEX	13
HEAVY DUPLEX	14
BREAKOUT	15

2. DROP CABLES

DROP	20
FLAT DROP	21
FLAT DROP FIG. 8	22

3. CLT CABLES

STANDARD	26
IMPROVED	27
FRP	28
CST	29
CST DOUBLE	30
SWA	31
MICRO	32

4. MLT CABLES

MICROCABLES	36
STANDARD	42
IMPROVED	49
CST	52
CST DOUBLE	55
SWA	57
ADSS	58
FIG. 8	64

5. SPECIAL CABLES

FIRE RESISTANT – FSC 90 min., FSC 180 min.	68
CPR	70
HYBRID	78
UNDERWATER	85
ARMoured MICRODUCT	89
FLES TUBE	90
TRACER WIRE	91

6. GENERAL SPECIFICATION

COLOUR CODE CHARTS	94
CODE TABLE	96
STRIPABILITY OF THE TIGHT BUFFERED FIBER	97
USED ABBREVIATIONS	97
PROPERTIES OF THE CABLE SHEATH	97
CHEMICAL RESISTANCE TABLE	98
FIRE PROPERTIES	99

7. INSTALLATION AND MANIPULATION

INTRODUCTION	102
MANIPULATION AND STORAGE	103
REWINDING/UNWINDING OF CABLE	105
BEND RADIUS OF CABLE	105
PULL STRENGTH OF CABLE	105
VERTICAL INSTALLATION	106
TWIST OF CABLE	107

Index

ID	page
11×1	12
12×1	12
13×1	12
14×1	12
15×1	12
16×1	12
17×1	12
18×1	12
19×1	12
21×1	13
22×1	13
23×1	13
24×1	13
26×1	13
28×1	13
32×1	14
34×1	14
38×1	14
41×1	15
42×1	15
42×8	17
44×1	15
44×8	17
49×1	15
7A01	20
82×1	16
A860	64
A862	64
AE00	26
AE02	26
AL00	33
AR00	27
AR02	27
AS01	58
BE00	26
BE02	26
BF01	28
BF02	28
BH01	29
BH02	29
BIF2	30
BIPI	30
BIP2	30
BR00	27
BR02	27
BWFI	31
BWF2	31
BWPI	31
BWP2	31
CE01	44
CE02	44
CH01	52

ID	page
CH02	52
CM01	38
CM02	38
CR01	49
CR02	49
DE01	48
DE02	48
DM01	39
DM02	39
F83A	65
FE01	45
FE02	45
FH01	53
FH02	53
FIF2	55
FIPI	55
FIP2	55
FLES	90
FR01	50
FR02	50
FWF2	57
FWPI	57
FXPK	86
G83A	65
GE01	45
GE02	45
GH01	53
GH02	53
GIF2	56
GIPI	56
GR01	50
GR02	50
GWF2	57
GWPI	57
GXPk	86
H83A	65
HE01	45
HE02	45
HH01	53
HH02	53
HIF2	56
HIP1	56
HR01	50
HR02	50
HWF2	57
HWPI	57
HXPk	86
IE00	45
IE02	45
IR01	51

ID	page
IR02	51
IXPK	86
KE01	48
KE02	48
KM01	39
KM02	39
L83A	65
LE01	45
LE02	45
LH01	53
LH02	53
LIF2	55
LIPI	55
LIP2	55
LR01	50
LR02	50
LWF2	57
LWPI	57
LXPk	86
N3HI	59
N3XI	60
N3YI	61
N4HI	59
N4RI	63
N4XI	60
N4YI	61
N4ZI	62
N5HI	59
N5RI	63
N5XI	60
N5YI	61
N5ZI	62
N6HI	59
N6RI	63
N6XI	60
N6YI	61
N6ZI	62
N7RI	63
N7SI	63
N9ZI	62
PE01	44
PE02	44
PH01	52
PH02	52
PM01	38
PM02	38
PR01	49
PR02	49
QM01	36
QM02	36

ID	page
QM5I	84
RE01	44
RE02	44
RH01	52
RH02	52
RM01	38
RM02	38
RR01	49
RR02	49
SE01	48
SE02	48
SM01	39
SM02	39
TM01	36
TM02	36
TM5I	84
Tracer w.91	
UE01	44
UE02	44
UM01	38
UM02	38
VE01	44
VE02	44
VH01	54
VH02	54
VM01	38
VM02	38
VR01	49
VR02	49
WM01	36
WM02	36
WM5I	84
Z001	78
Z006	32
Z008	32
Z019	36
Z022	41
Z024	40
Z025	40
Z026	12
Z041	21
Z042	22
Z043	21
Z044	32
Z045	40
Z046	22
Z047	79
Z049	37

ID	page
Z078	80
Z090	47
Z108	36
Z130	80
Z131	81
Z132	81
Z144	29
Z145	29
Z159	58
Z174	12
Z175	13
Z176	14
Z182	47
Z187	64
Z194	58
Z202	36
Z212	82
Z235	14
Z236	20
Z237	20
Z238	32
Z279	14
Z281	69
Z282	69
Z283	69
Z284	69
Z285	69
Z297	68
Z298	68
Z299	68
Z300	68
Z304	42
Z320	83
Z339	33
Z349	43
Z350	43
Z366	33
Z387	89
Z388	88
Z393	40
Z410	89
Z436	41
Z437	41
Z438	46
Z439	87
ZNx0	70
ZN01	74
ZN02	71
ZN03	76
ZN04	77
ZN05	73
ZN06	72
ZN07	75

History and present of **KABELOVNA** Děčín Podmokly



KDP was founded in 1909 and 1910 as a branch of the Bergmann cable plants in Berlin, the original name of the company being „Rakouské Bergmannovy závody spol. s r.o., Vídeň, továrna Podmokly“.

From the very outset the plant manufactured all types of power and communications cables with lead casing and the relevant cable sets, as well as rubber-insulated conductors, dynamo wires and insulation pipes with accessories. Company activity at that time also included projects involving electrical equipment and its installation.

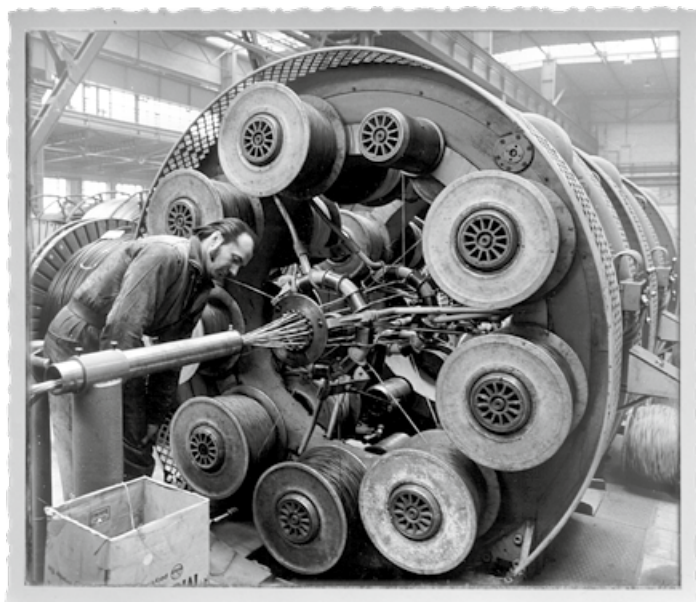
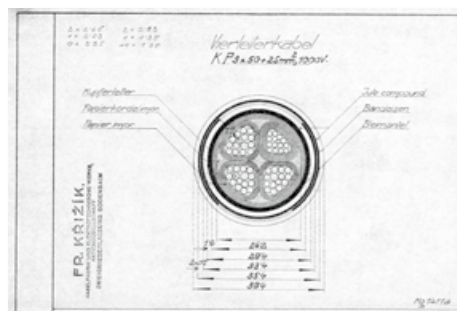

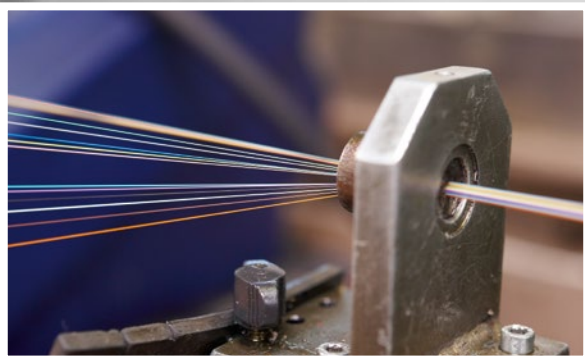

The cable factory came into the hands of Anglo-Pragobanka as part of Křížík a spol. Praha after the First World War and this company reconstructed the entire business. The production of trunk communications cables got underway at this time. The cable factory and neighbouring copper works were then merged in 1932 as the „Měďárna, kabelovna a elektrotechnické závody Křížík-Chaudoir, Praha“. However, the production programme at the cable factory did not change too radically.

The company was nationalised after 1945. It was later incorporated as part of KABLO Kladno and its specialisation amplified. The main production programme became the manufacture of communications cables and in 1961 KABLO Děčín became the monopoly producer of cables for local and long-distance telecommunications networks using top-of-the-range technology. The company was privatised after 1990, became independent again and returned to its traditional name of KABELOVNA Děčín-Podmokly, a.s. SIEMENS AG then entered the company in 1992. The result of mutual cooperation here was considerable modernisation of production technology, the expansion of the range produced and the strengthening of KABELOVNA Děčín- Podmokly, a.s. on global markets.

SIEMENS sold its share in KABELOVNA to American venture-capital fund Bancroft Eastern Europe Fund L.P. in July 2000, before this company in turn sold its share to American company CDT (Cable Design Technology) in December 2001. CDT then merged with American company BELDEN in 2004, the newly-founded company taking on the name of Belden CDT Inc. 2007 the cable works is sold to Wilms Gruppe, the company is divided into Kabelovna Děčín Podmokly, s.r.o. and KDP Assembly, s.r.o.

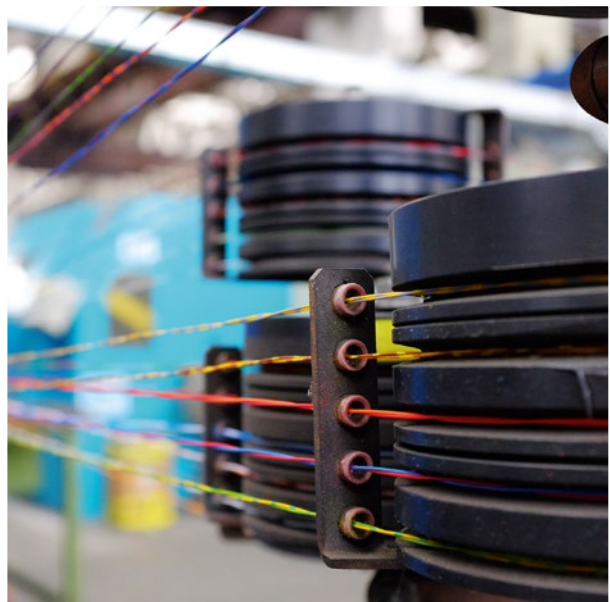

History

4. 9. 1909	Execution of contract on establishment of company „Rakouské Bergmanovy závody, Berlín, elektrotechnická společnost, s. r. o.“ with branch in Vienna.
27. 6. 1911	Launch of Production – 750 employees. Production of power and communication cables, cable sets and accessories, rubber wires and insulation tubes including accessories.
05/1919	The company was acquired by „Elektrotechnické závody František Křížik, Praha, a. s.“ Initiation of remote communication cables production.
03/1930	The company completely burnt down. Production restored at the end of year 1930.
05/1945	The company came under national control of Křížik a. s. corporation. Then it was nationalized and became a part of national company KABLO Bratislava. Production of power and communication cables with lead coating, rubberized wires and coil wires.
1. 1. 1950	Establishment of national company KABLO Děčín.
1959	Production of remote communication cables.
1961	KABLO Děčín became a monopoly producer of communication cables for local networks.
1982–1984	Construction of new hall to expand the production of communication cables.
1985	Termination of power cables production.
1988	Initiation of optic cables production.
31. 12. 1990	Privatization, establishment of incorporated company. The original name KABELOVNA Děčín Podmokly, a. s. was used.
1992	Company share acquisition by SIEMENS AG.
1994	Initiation of cable assemblies production.
1995	ISO 9001 certification completed.
1996	Initiation of installation cables production.
1996	Czech Republic Quality Award.
1998	ISO 14001 certification completed.
2000	Establishment of subsidiary company KDP Kabeltechnik Berlin, GmbH.
2000	Sale of SIEMENS AG share to investment fund BANCROFT CZ.
2001	CDT Pittsburgh becomes a majority owner of the company.
2002	Complete renewal of optic cable assortment.
2003	Initiation of data cable production.
2004	Merge with Belden company, Belden CDT inc. was established.
2007	Wilms Gruppe becomes a new owner of KABELOVNA.
2010	KABELOVNA Děčín Podmokly, s.r.o. celebrates 100 th Anniversary.
2015	New portfolio of cable constructions.
1. 1. 2016	KABELOVNA Děčín Podmokly, s.r.o. has become a member of FTTH Council.
2022	KDP has become a member of Association of Cable Manufacturers.

Certificates and CPR

KDP
WORLD CONNECTING CABLES

DECLARATION OF PERFORMANCE
No. 2/23

1. Unique identification code of the product type:	JJA-DQ(BN)(SR)H 12,24 (ZD01)
2. Intended uses:	Communication fiber optical cable
3. Manufacturer:	KABELOVNA Děčín Podmokly, s.r.o., Ústecká 840/33, 405 33 Děčín 5, CZECH REPUBLIC
4. Authorised representative:	-
5. System's of AVCP:	14
6. Harmonised standard:	EN 60754:2014+A1:2016
Notified bodies:	ELEKTROTECHNICKÝ ZKUSEBNÍ ÚSTAV s.p., No. 1014
7. Declared performance's:	Reaction to fire: B2ca-s10da1 Dangerous substances: NPD
8. Appropriate Technical Documentation and/or Specific Technical Documentation:	Test report No.: 212740-01/02 18.12.2021

The performance of the product identified above is in conformity with the set of declared performance's. This declaration of performance is issued, in accordance with Regulation (EU) No. 305/2011, under the sole responsibility of the manufacturer identified above.

Place of issue: Děčín Date of issue: 9.2.2023

Signed for and on behalf of the manufacturer: Ing. Lenka Máčlová

Function: Commercial director



KABELOVNA Děčín Podmokly, s.r.o.
Ústecká 840/33 | 405 33 Děčín
Česká republika

Informace o společnosti: www.kdp.cz | IČ: 25799993 | DIČ: CZ25799993

KDP
WORLD CONNECTING CABLES

Head office: +420 472 708 111
E-mail: cert@kdp.cz
www.kdp.cz

TUV NORD

CERTIFICATE

Management system as per
EN ISO 14001 : 2015

The Certification Body TÜV NORD CERT GmbH hereby confirms as a result of the audit, assessment and certification decision according to ISO/IEC 17021-1:2015, that the organization

KABELOVNA Děčín Podmokly, s.r.o. 
Ústecká 840/33
405 33 Děčín
Czech Republic

operates a management system in accordance with the requirements of ISO 14001 : 2015 and will be assessed for conformity within the 3 year term of validity of the certificate.

Scope

Production and testing of metallic and optical cables.

Certificate Registration No. 44 104 950276 Valid from 08.03.2023
Audit report No. 20062022 Valid until 07.03.2026
Initial certification 1996

Certification Body at TÜV NORD CERT GmbH Praha, 10.02.2023

Validity can be verified at <https://www.tuv-nord.de/de/unternehmen/certification/zertifizierungsdatenbank>.

TÜV NORD CERT GmbH Am TÜV 1 45307 Essen www.tuv-nord-cert.com

TUV NORD

CERTIFICATE

Management system as per
EN ISO 9001 : 2015

The Certification Body TÜV NORD CERT GmbH hereby confirms as a result of the audit, assessment and certification decision according to ISO/IEC 17021-1:2015, that the organization

KABELOVNA Děčín Podmokly, s.r.o. 
Ústecká 840/33
405 33 Děčín
Czech Republic

operates a management system in accordance with the requirements of ISO 9001 : 2015 and will be assessed for conformity within the 3 year term of validity of the certificate.

Scope

Production and testing of metallic and optical cables.

Certificate Registration No. 44 100 950276 Valid from 04.03.2023
Audit report No. 20032022 Valid until 03.03.2026
Initial certification 1995

Certification Body at TÜV NORD CERT GmbH Praha, 10.02.2023

Validity can be verified at <https://www.tuv-nord.de/de/unternehmen/certification/zertifizierungsdatenbank>.

TÜV NORD CERT GmbH Am TÜV 1 45307 Essen www.tuv-nord-cert.com



A close-up photograph of a cable assembly, showing a metal panel with several circular ports. Each port has a thin, light-colored cable or fiber optic strand inserted. The background is blurred, showing more of the assembly. A large, semi-transparent green circle is overlaid on the right side of the image, containing text.

1. TIGHT BUFFERED CABLES

- SIMPLEX
- DUPLEX
- HEAVY DUPLEX
- BREAKOUT

SIMPLEX

Specification: 16×1, 17×1, 11×1, 12×1, 14×1, 15×1, 18×1, 19×1, 13×1, Z026, Z174



Indoor



FTTx



Data center



Halogen free

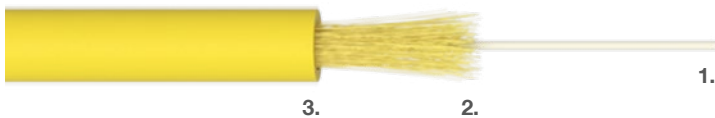

Description of materials:

1. FR-LSZH buffered optical fiber. **2.** Waterblocking aramid yarn. **3.** FR-LSZH outer jacket.

Temperature range

Installation -5 to +50 °C

Operation -5 to +50 °C

Storage -5 to +50 °C

Design code	Simplex diameter [mm]	Cable weight [kg/km]	Max. load (installation) [N]	Crush resistance [N/10 cm]
16×1	1.6	3	100	500
17×1	1.7	3	100	500
11×1	1.8	4	100	500
12×1	2.0	5	100	500
14×1	2.4	7	250	500
15×1	2.5	7	300	500
18×1	2.8	8	300	500
19×1	2.9	9	300	500
13×1	3.0	9	300	500
Z026	2.3	7	250	500
Z174	2.6	8	300	500

DUPLEX

Specification: 26×1, 21×1, 22×1, 24×1, 28×1, 23×1, Z175



Indoor



FTTx



Data center



Halogen free

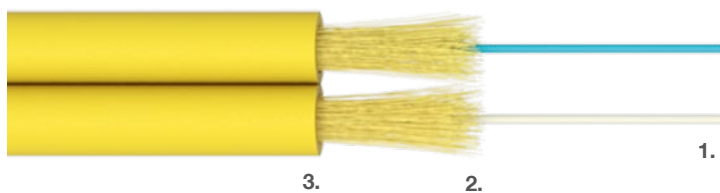

Description of materials:

1. FR-LSZH buffered optical fibers. **2.** Waterblocking aramid yarn. **3.** FR-LSZH outer jacket.

Temperature range

Installation	-5 to +50 °C
Operation	-5 to +50 °C
Storage	-5 to +50 °C

Design code	Cable outer diameter [mm]	Cable weight [kg/km]	Max. load (installation) [N]	Crush resistance [N/10 cm]
26×1	1.6 × 3.4	6	200	1,000
21×1	1.8 × 3.8	7	200	1,000
22×1	2.0 × 4.3	9	200	1,000
24×1	2.4 × 5.1	12	500	1,000
28×1	2.8 × 5.9	17	500	1,000
23×1	3.0 × 6.3	20	500	1,000
Z175	2.6 × 5.6	14	500	1,000

TIGHT BUFFERED

HEAVY DUPLEX

Specification: 32×1, 34×1, 38×1, Z176, Z235, Z279



Indoor



FTTx



Data center



Halogen free

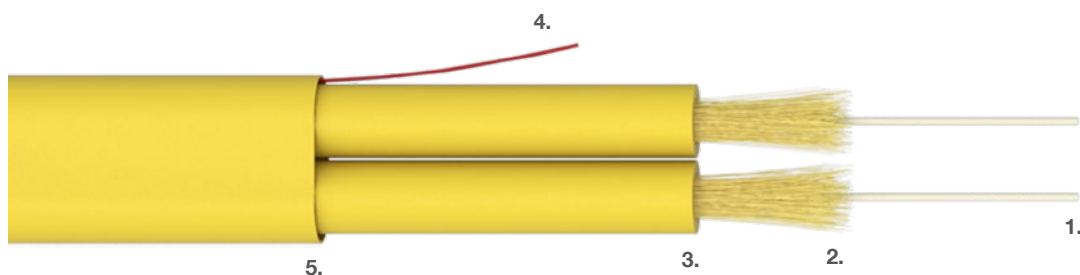

Description of materials:

- 1.** FR-LSZH buffered optical fibers. **2.** Waterblocking aramid yarn. **3.** FR-LSZH inner jacket. **4.** Rip-Cord.
5. FR-LSZH outer jacket, UV stable.

Temperature range	32×1, 34×1, 38×1, Z176	Z235, Z279
Installation	0 to +50 °C	-15 to +50 °C
Operation	0 to +50 °C	-20 to +70 °C
Storage	0 to +50 °C	-20 to +70 °C

Design code	Cable outer diameter [mm]	Cable weight [kg/km]	Max. load (installation) [N]	Crush resistance [N/10 cm]
32×1	3.0 × 5.0	19	200	1,000
34×1	3.6 × 6.0	28	500	1,000
38×1	4.2 × 7.0	35	500	1,000
Z176	3.6 × 6.2	28	600	1,000
Z235	3.0 × 5.0	18	200	1,000
Z279	4.2 × 7.0	33	500	1,000

BREAKOUT STANDARD

Specification: 41×1, 42×1, 44×1, 49×1



Indoor



FTTx



Data center



Halogen free

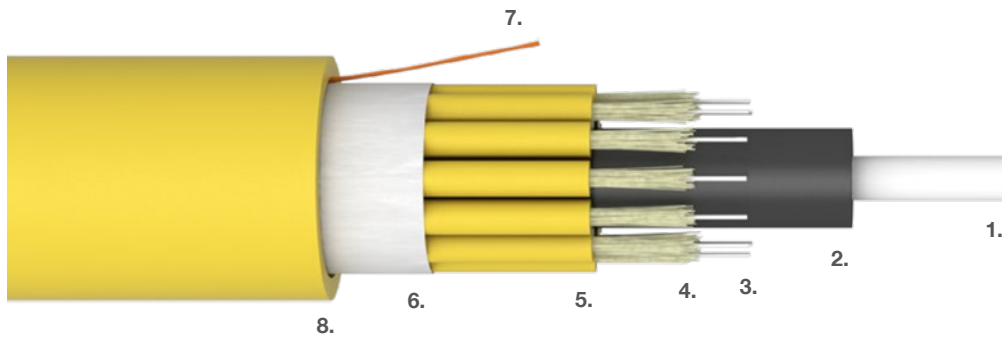

Description of materials:

1. Central FRP strength member. 2. PE coating for central FRP strength member when necessary.
3. FR-LSZH buffered optical fibers. 4. Waterblocking aramid yarn. 5. Simplex cable. 6. Water-swellable tape.
7. Rip-Cord. 8. FR-LSZH outer jacket, UV stable.

Temperature range	41×1, 49×1	42×1, 44×1
Installation	-5 to +40 °C	-5 to +50 °C
Operation	-5 to +50 °C	-20 to +60 °C
Storage	-25 to +60 °C	-20 to +60 °C

Design code	Max. fiber count	Simplex diameter [mm]	Cable outer diameter [mm]	Cable weight [kg/km]	Max. load (installation) [N]	Crush resistance [N/10 cm]
41×1	36	1.8	15.0	226	3,500	2,000
42×1	48	2.0	19.0	339	5,000	1,500
44×1	24	2.4	16.8	277	4,000	1,500
49×1	24	2.9	19.7	334	3,200	1,500

TIGHT BUFFERED

BREAKOUT NO CSM

Specification: 82x1



Indoor



FTTx



Data center



Halogen free

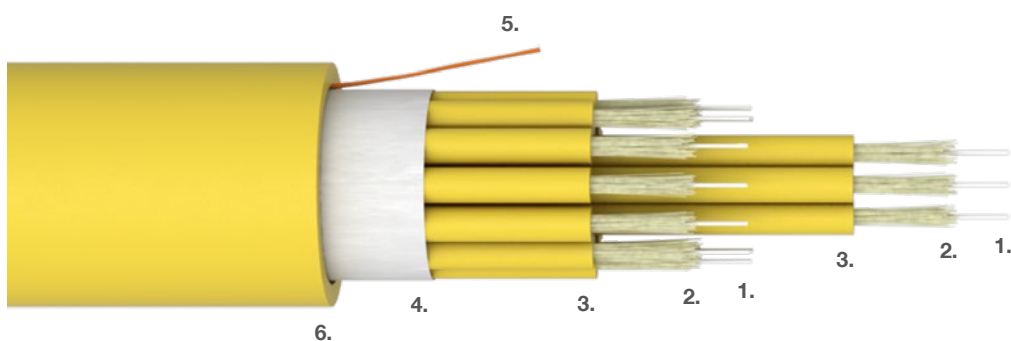

Description of materials:

1. FR-LSZH buffered optical fibers. **2.** Waterblocking aramid yarn. **3.** Simplex cable. **4.** Water-swallowable tape. **5.** Rip-Cord. **6.** FR-LSZH outer jacket, UV stable.

Temperature range

Installation	-5 to +50 °C
Operation	-20 to +60 °C
Storage	-20 to +60 °C

Design code	Max. fiber count	Simplex diameter [mm]	Cable outer diameter [mm]	Cable weight [kg/km]	Max. load (installation) [N]	Crush resistance [N/10 cm]
82x1	48	2.0	18.7	314	300	1,000

BREAKOUT IMPROVED

Specification: 42x8, 44x8



Indoor



FTTx



Data center



Halogen free



High tensile

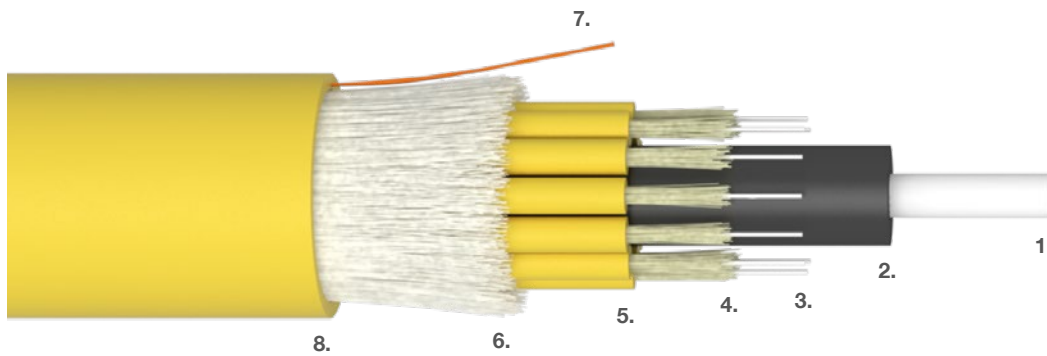

Description of materials:

1. Central FRP strength member. 2. PE coating for central FRP strength member when necessary.
3. FR-LSZH buffered optical fibers. 4. Waterblocking aramid yarn. 5. Simplex cable.
6. Waterblocking E-glass yarn. 7. Rip-Cord. 8. FR-LSZH outer jacket, UV stable.

Temperature range	42x8	44x8
Installation	-5 to +40 °C	-5 to +40 °C
Operation	-20 to +60 °C	-5 to +50 °C
Storage	-20 to +60 °C	-25 to +60 °C

Design code	Max. fiber count	Simplex diameter [mm]	Cable outer diameter [mm]	Cable weight [kg/km]	Max. load (installation) [N]	Crush resistance [N/10 cm]
42x8	24	2.0	15.7	248	4,500	2,000
44x8	24	2.4	18.1	334	5,500	2,000

TIGHT BUFFERED

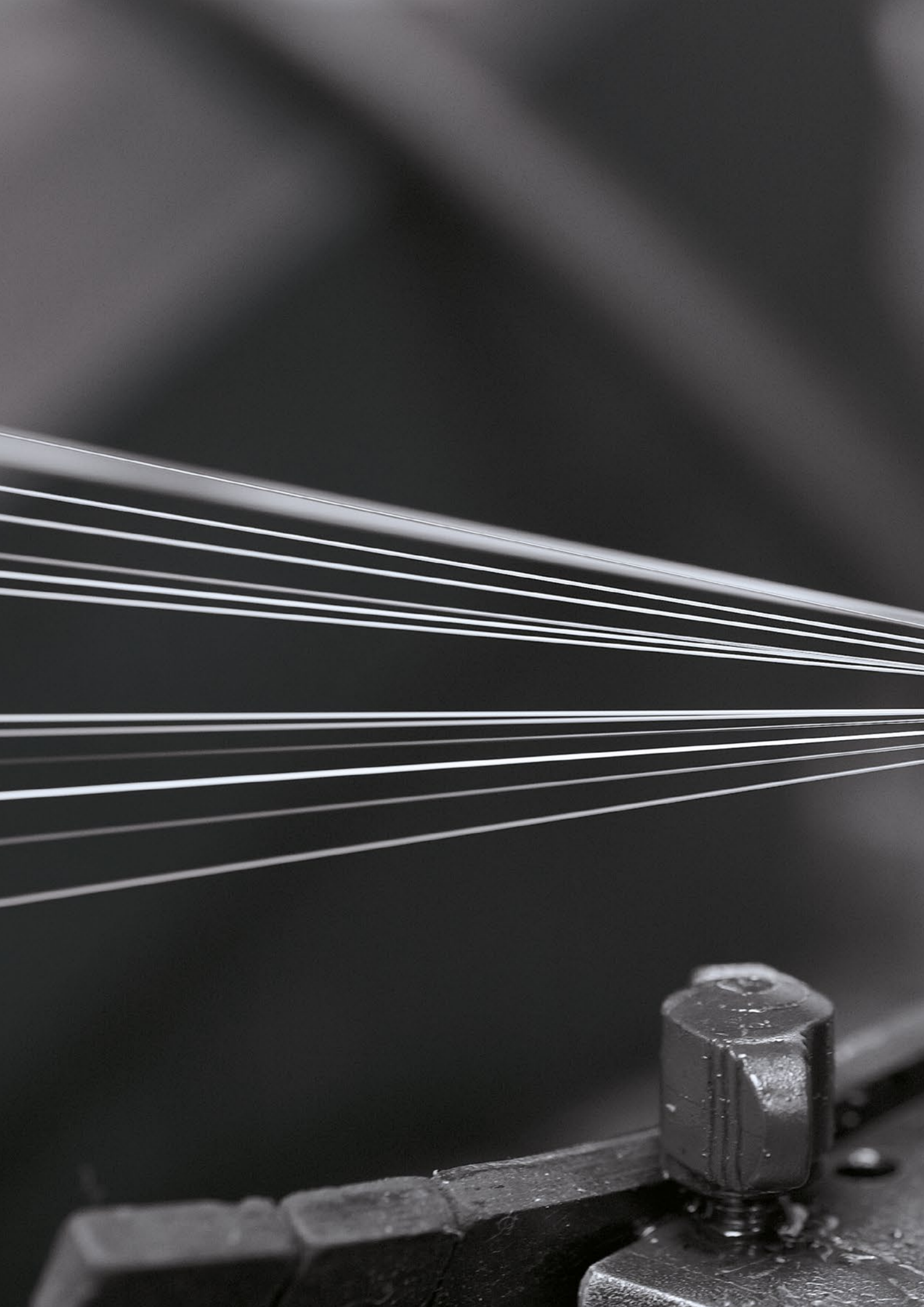



2. DROP CABLES

- DROP
- FLAT DROP
- FLAT DROP FIG. 8

DROP

Specification: 7A01, Z236, Z237



Indoor



Outdoor



FTTx



Halogen free



Aerial

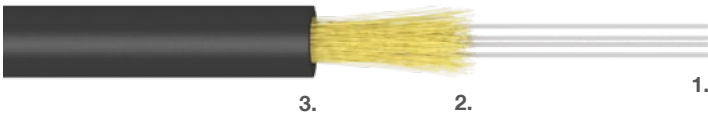

Description of materials:

1. Optical fibers. 2. Aramid yarn. 3. FR-LSZH outer jacket, UV stable.

Temperature range

Installation -5 to +50 °C

Operation -20 to +60 °C

Storage -20 to +60 °C

Design code	Fiber count	Cable outer diameter [mm]	Cable weight [kg/km]	Max. load (installation) [N]	Crush resistance [N/10 cm]
7A01	1-6	3.0	10	500	1,000
7A01	8-12	3.4	12	500	1,000
7A01	16	3.7	14	500	1,000
7A01	24	4.0	16	500	1,000
Z236	1-12	3.4	13	700	1,000
Z237	2	3.0	11	1,000	1,000
Z237	4	3.2	11	1,000	1,000
Z237	8	3.2	12	1,000	1,000
Z237	12	3.4	13	1,000	1,000

FLAT DROP

Specification: Z041, Z043



Indoor



Outdoor



FTTx



Halogen free



Aerial

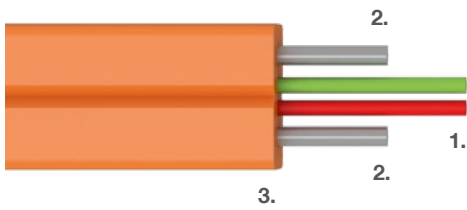

Description of materials:

1. Optical fibers. 2. Steel wire or FRP. 3. FR-LSZH outer jacket, UV stable.

Temperature range

Installation	-15 to +50 °C
Operation	-30 to +70 °C
Storage	-30 to +70 °C

Design code	Fiber count	Cable outer diameter [mm]	Cable weight [kg/km]	Max. load (installation) [N]	Crush resistance [N/10 cm]
Z041	2	2 × 3.0	10	300	4,000
Z043	2	2 × 3.0	8	100	4,000

FLAT DROP FIG. 8

Specification: Z042, Z046



Indoor



Outdoor



FTTx



Halogen free



Aerial

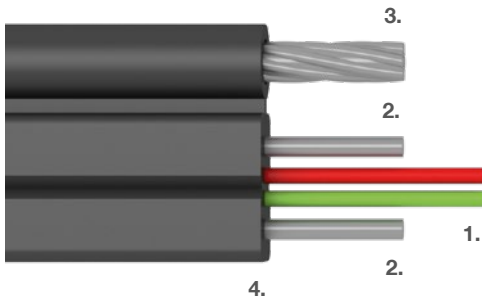

Description of materials:

1. Optical fibers. 2. Steel wire or FRP. 3. Steel wire messenger Ø 1.0 mm.
4. FR-LSZH outer jacket, UV stable.

Design code	Fiber count	Cable outer diameter [mm]	Cable weight [kg/km]	Max. load (installation) [N]	Crush resistance [N/10 cm]
Z042	2	2 × 5.2	20	800	4,000
Z046	2	2 × 5.2	18	800	4,000

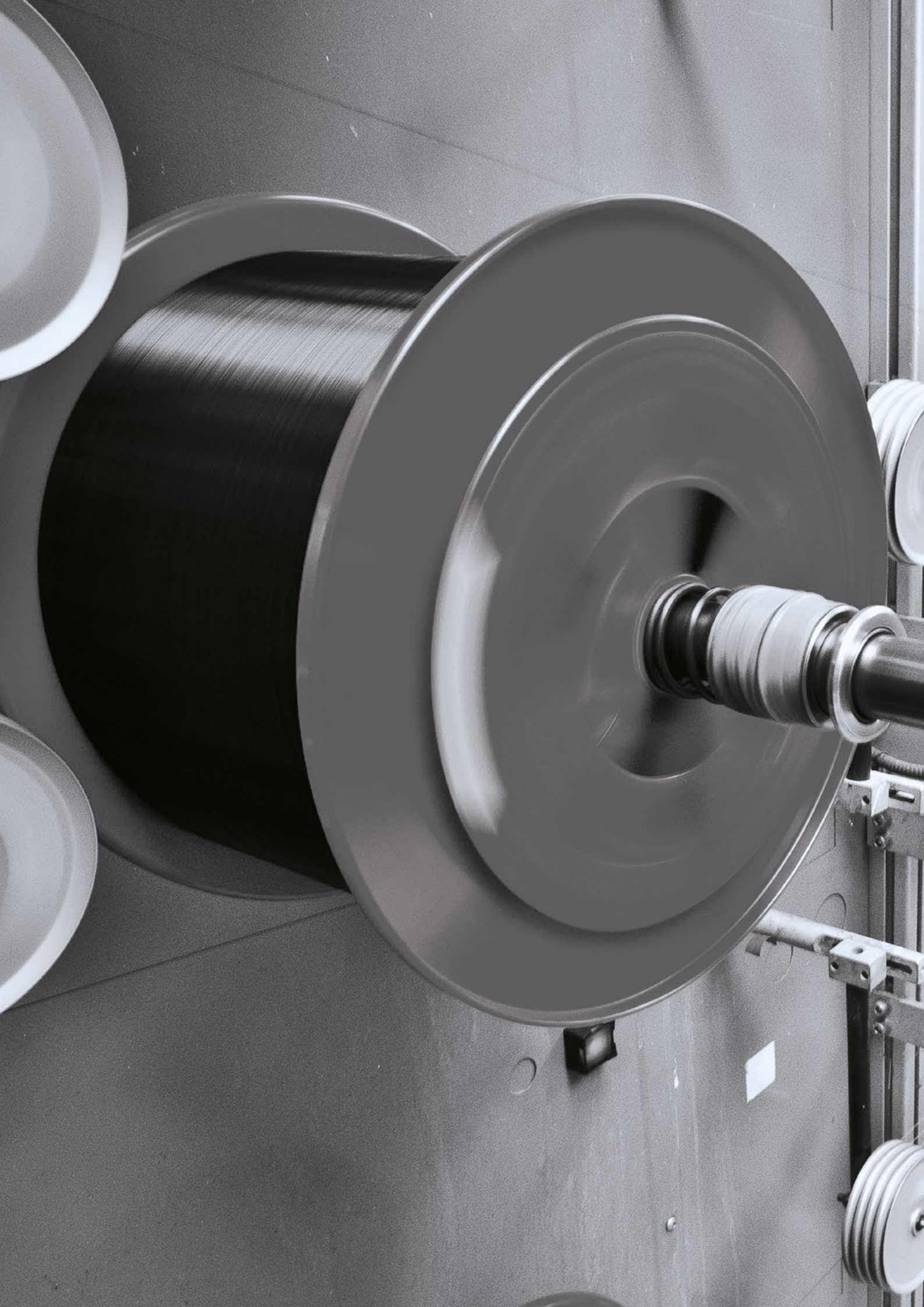



3. CLT CABLES

- STANDARD
- IMPROVED
- FRP
- CST SINGLE
- FRP DOUBLE
- CST DOUBLE
- SWA
- MICRO

CLT STANDARD

Specification: AE00, BE00, AE02, BE02



Indoor



Outdoor



FTTx



Halogen free

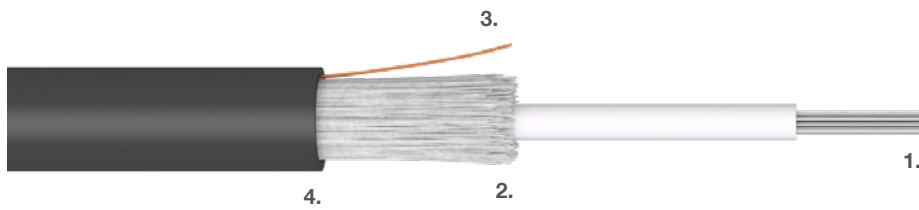

Description of materials:

1. Gel filled PBT loose tube with optical fibers.
2. Waterblocking E-glass yarn.
3. Rip-Cord.
4. FR-LSZH or PE outer jacket, UV stable.

Temperature range

Installation	-15 to +50 °C
Operation	-20 to +70 °C
Storage	-20 to +70 °C

Design code	Max. fiber count	Loose tube diameter [mm]	Cable size [mm]	Cable weight [kg/km]	Max. load (installation) [N]	Crush resistance [N/10 cm]
AE00	12	2.5	5.4	27	1,100	2,000
BE00	24	3.0	5.8	31	1,100	2,000
AE02	12	2.5	5.4	35	1,100	2,000
BE02	24	3.0	6.4	48	1,100	2,000

CLT IMPROVED

Specification: AR00, BR00, AR02, BR02



Indoor



Outdoor



FTTx



Halogen free



High tensile

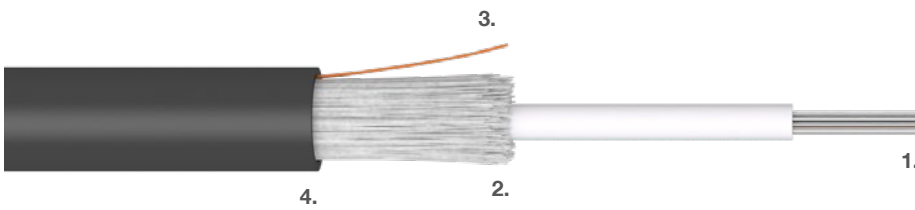

Description of materials:

1. Gel filled PBT loose tube with optical fibers.
2. Waterblocking E-glass yarn.
3. Rip-Cord.
4. FR-LSZH or PE outer jacket, UV stable.

Temperature range

Installation	-15 to +50 °C
Operation	-20 to +70 °C
Storage	-20 to +70 °C

Design code	Max. fiber count	Loose tube diameter [mm]	Cable size [mm]	Cable weight [kg/km]	Max. load (installation) [N]	Crush resistance [N/10 cm]
AR00	12	2.5	6.5	39	2,000	2,000
BR00	24	3.0	7.7	51	2,500	2,000
AR02	12	2.5	6.5	50	2,000	2,000
BR02	24	3.0	7.7	68	2,500	2,000

CLT FRP

Specification: BF01, BF02



Indoor



Outdoor



FTTx



Halogen free



Armoured



Dielectric



Direct
burial

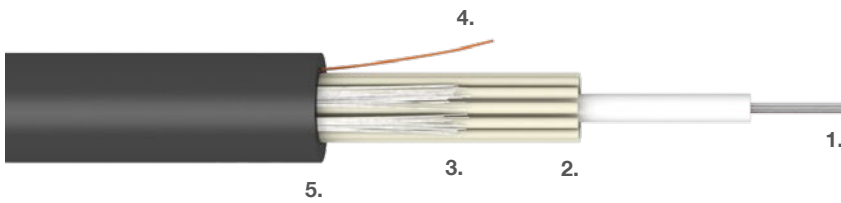

Description of materials:

1. Gel filled PBT loose tube with optical fibers. 2. FRP dielectric strength member.
3. Waterblocking E-glass yarn. 4. Rip-Cord. 5. FR-LSZH or PE outer jacket, UV stable.

Temperature range

Installation -15 to +50 °C

Operation -40 to +70 °C

Storage -40 to +70 °C

Design code	Max. fiber count	Loose tube diameter [mm]	Cable size [mm]	Cable weight [kg/km]	Max. load (installation) [N]	Crush resistance [N/10 cm]
BF01	24	3.0	7.4	53	2,300	3,000
BF02	24	3.0	7.4	65	2,300	3,000

CLT CST

Specification: BH01, BH02, Z144, Z145

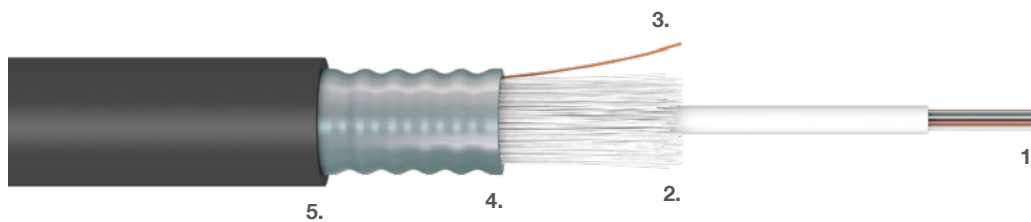

Description of materials:

- 1.** Gel filled PBT loose tube with optical fibers. **2.** Waterblocking E-glass yarn. **3.** Rip-Cord.
4. Corrugated steel tape. **5.** FR-LSZH or PE outer jacket, UV stable.

Temperature range

Installation	-15 to +50 °C
Operation	-40 to +70 °C
Storage	-40 to +70 °C

Design code	Max. fiber count	Loose tube diameter [mm]	Cable size [mm]	Cable weight [kg/km]	Max. load (installation) [N]	Crush resistance [N/10 cm]
BH01	24	3.0	9.9	98	2,500	10,000
BH02	24	3.0	10.1	120	2,500	10,000
Z144	24	3.0	7.7	70	1,100	10,000
Z145	24	3.0	7.9	87	1,100	10,000

CLT CST DOUBLE JACKET

Specification: BIPI, BIF2, BIP2



Indoor



Outdoor



FTTx



Halogen free



Armoured



Antirodent



Direct
burial

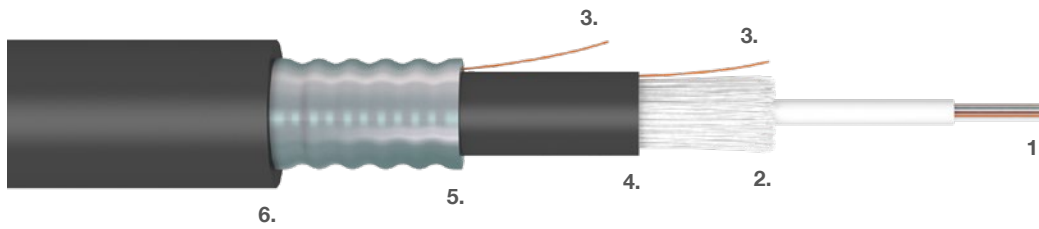

Description of materials:

1. Gel filled PBT loose tube with optical fibres. 2. Waterblocking E-glass yarn. 3. Rip-Cord.
4. FR-LSZH or PE inner jacket. 5. Corrugated steel tape. 6. FR-LSZH or PE outer jacket, UV stable.

Temperature range

Installation -15 to +50 °C

Operation -40 to +70 °C

Storage -40 to +70 °C

Design code	Max. fiber count	Loose tube diameter [mm]	Cable size [mm]	Cable weight [kg/km]	Max. load (installation) [N]	Crush resistance [N/10 cm]
BIPI	24	3.0	10.5	106	1,100	6,000
BIF2	24	3.0	10.5	138	1,100	6,000
BIP2	24	3.0	10.5	131	1,100	6,000

CLT SWA

Specification: BWPI, BWP2, BWFI, BWF2

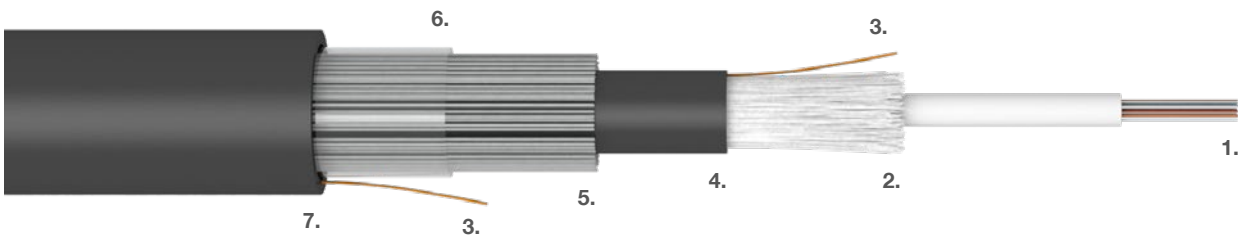

Description of materials:

- 1. Gel filled PBT loose tube with optical fibers. 2. Waterblocking E-glass yarn. 3. Rip-Cord.
- 4. FR-LSZH or PE inner jacket. 5. Steel Wire Armour (SWA). 6. Water-swellable tape.
- 7. FR-LSZH or PE outer jacket, UV stable.

Temperature range

Installation	-15 to +50 °C
Operation	-30 to +70 °C
Storage	-30 to +70 °C

Design code	Max. fiber count	Loose tube diameter [mm]	Cable size [mm]	Cable weight [kg/km]	Max. load (installation) [N]	Crush resistance [N/10 cm]
BWPI	24	3.0	11.0	199	4,000	4,000
BWP2	24	3.0	11.0	208	4,000	4,000
BWFI	24	3.0	11.0	231	4,000	4,000
BWF2	24	3.0	11.0	222	4,000	4,000

CLT MICRO

Specification: Z044, Z008, Z006, Z238



Indoor



Outdoor



FTTx



Halogen free



Duct



Air blown



Description of materials:

1. Optical fibres. **2.** Gell filled PBT loose tube. **3.** Low Friction Polymer.

Temperature range

Installation	-5 to +50 °C
Operation	-20 to +70 °C
Storage	-20 to +70 °C

Design code	Max. fiber count	Loose tube diameter [mm]	Cable size [mm]	Cable weight [kg/km]	Max. load (installation) [N]	Crush resistance [N/10 cm]
Z044	4	2.0	2.0	4	70	1,000
Z008	12	2.5	2.5	6	70	1,000
Z006	12	2.8	2.8	8	70	1,000
Z238	24	3.2	3.2	10	70	1,000

CLT MICRO

Specification: AL00, Z339, Z366



Outdoor



FTTx



Duct



Air blown

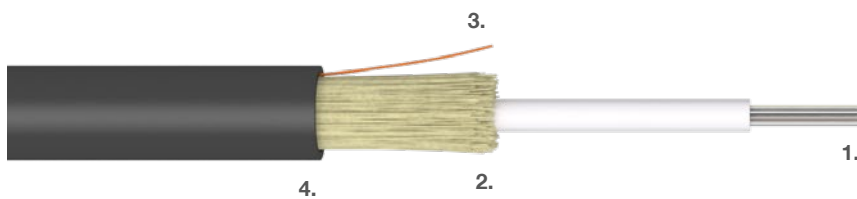

Description of materials:

1. Gel filled PBT loose tube with optical fibers.
2. Waterblocking aramid yarn.
3. Rip-Cord.
4. PE outer jacket, UV stable.

Temperature range

Installation	-15 to +50 °C
Operation	-20 to +70 °C
Storage	-20 to +70 °C

Design code	Max. fiber count	Loose tube diameter [mm]	Cable size [mm]	Cable weight [kg/km]	Max. load (installation) [N]	Crush resistance [N/10 cm]
AL00	12	2.3	3.4	10	250	1,000
Z339	12	1.7	2.5	5	90	700
Z366	24	2.5	3.5	10	90	700



A close-up, black and white photograph of a cable being processed by a machine. The cable is being fed into a circular opening of a metal component. The machine has several circular openings and a small screw-like fastener at the top. The background is dark and out of focus. A large, semi-transparent brown circle is overlaid on the right side of the image, containing the text.

4. MLT CABLES

- MICROCABLES
- STANDARD
- IMPROVED
- CST
- SWA
- ADSS
- FIG. 8

MICROCABLES

Specification: Z019, TM01, TM02, QM01, QM02, WM01, WM02, Z202, Z108



Indoor



Outdoor



FTTx



Halogen free



Air blown



Duct

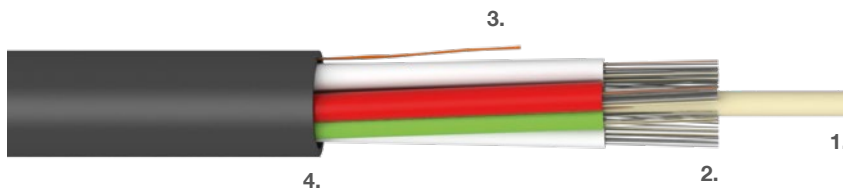

Description of materials:

- 1.** FRP dielectric central strength member. **2.** Gel filled PBT loose tube with optical fibers.
3. Rip-Cord. **4.** FR-LSZH or PE outer jacket, UV stable.

Temperature range

Installation -15 to +50 °C

Operation -30 to +70 °C

Storage -40 to +70 °C

Design code	Max. fiber count	Loose tube diameter [mm]	Cable size [mm]	Cable weight [kg/km]	Max. load (installation) [N]	Crush resistance [N/10 cm]
Z019	60	1.5	5.2	22	250	1,500
TM01	72	1.5	5.8	29	700	1,500
TM02	72	1.5	6.8	48	700	1,500
QM01	96	1.5	6.5	40	1,400	1,500
QM02	96	1.5	7.5	62	1,400	1,500
WM01	144	1.5	8.6	62	1,500	1,500
WM02	144	1.5	9.6	91	1,500	1,500
Z202	144	1.5	7.1	43	450	1,500
Z108	192	1.5	8.0	53	700	1,500

MICROCABLES

Specification: Z049



Outdoor



FTTx



Halogen free



Air blown



Duct

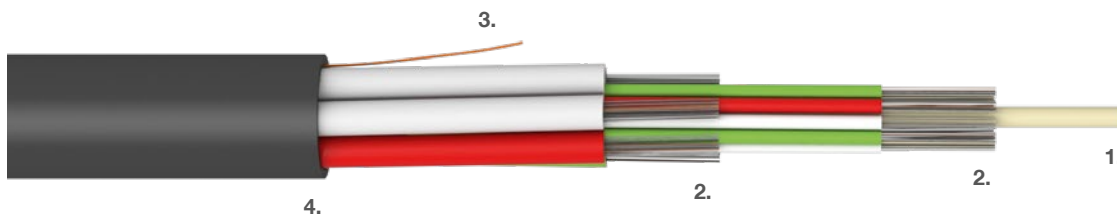

Description of materials:

1. FRP dielectric central strength member. 2. Gel filled PBT loose tube with optical fibers.
3. Rip-Cord. 4. PE outer jacket, UV stable.

Temperature range

Installation	-15 to +50 °C
Operation	-30 to +70 °C
Storage	-40 to +70 °C

Design code	Max. fiber count	Loose tube diameter [mm]	Cable size [mm]	Cable weight [kg/km]	Max. load (installation) [N]	Crush resistance [N/10 cm]
Z049	288	1.5	10.2	87	1,100	1,500

MICROCABLES

Specification: UM01, UM02, CM01, CM02, PM01, PM02, RM01, RM02, VM01, VM02



Indoor



Outdoor



FTTx



Halogen free



Air blown



Duct

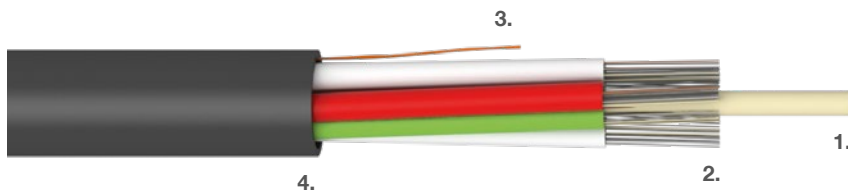

Description of materials:

- 1.** FRP dielectric central strength member. **2.** Gel filled PBT loose tube with optical fibers.
3. Rip-Cord. **4.** FR-LSZH or PE outer jacket, UV stable.

Temperature range

Installation -15 to +50 °C

Operation -40 to +70 °C

Storage -40 to +70 °C

Design code	Max. fiber count	Loose tube diameter [mm]	Cable size [mm]	Cable weight [kg/km]	Max. load (installation) [N]	Crush resistance [N/10 cm]
UM01	60	1.7	5.7	27	320	1,500
UM02	60	1.7	6.7	53	320	1,500
CM01	72	1.7	6.2	33	680	1,500
CM02	72	1.7	7.2	61	680	1,500
PM01	96	1.7	7.4	50	2,400	1,500
PM02	96	1.7	8.4	84	2,400	1,500
RM01	144	1.7	9.6	76	2,700	1,500
RM02	144	1.7	10.6	119	2,700	1,500
VM01	216	1.7	9.5	72	700	1,500
VM02	216	1.7	10.5	105	700	1,500

MICROCABLES

Specification: DM01, DM02, KM01, KM02, SM01, SM02



Indoor



Outdoor



FTTx



Halogen free



Air blown



Duct

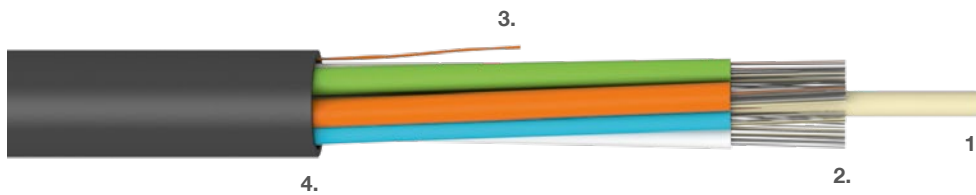

Description of materials:

- 1. FRP dielectric central strength member. 2. Gel filled PBT loose tube with optical fibers.
- 3. Rip-Cord. 4. FR-LSZH or PE outer jacket, UV stable.

Temperature range

Installation	-15 to +50 °C
Operation	-30 to +70 °C
Storage	-40 to +70 °C

Design code	Max. fiber count	Loose tube diameter [mm]	Cable size [mm]	Cable weight [kg/km]	Max. load (installation) [N]	Crush resistance [N/10 cm]
DM01	144	2.5	8.7	58	200	1,000
DM02	144	2.5	9.7	87	200	1,000
KM01	192	2.5	10.2	83	1,000	1,000
KM02	192	2.5	11.2	117	1,000	1,000
SM01	288	2.5	13.3	138	1,500	1,000
SM02	288	2.5	14.3	182.	1,500	1,000

MICROCABLES 200 μ m

Specification: Z393, Z024, Z045, Z025



Outdoor



FTTx



Halogen free



Air blown



Duct

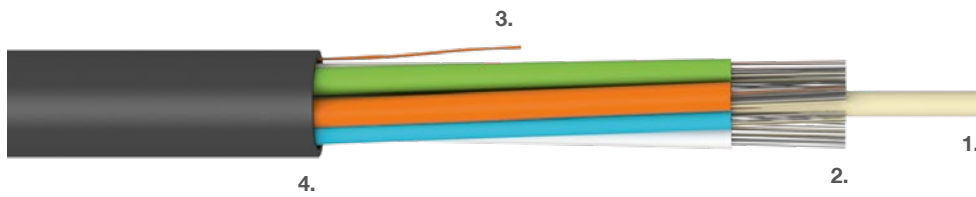

Description of materials:

- 1.** FRP dielectric central strength member. **2.** Gel filled PBT loose tube with up to 24 200 μ m optical fibers.
3. Rip-Cord. **4.** PE outer jacket, UV stable.

Temperature range

Installation -5 to +50 °C

Operation -20 to +60 °C

Storage -20 to +60 °C

Design code	Max. fiber count	Loose tube diameter [mm]	Cable size [mm]	Cable weight [kg/km]	Max. load (installation) [N]	Crush resistance [N/10 cm]
NEW Z393	96	1.7	5.4	27	90	50
Z024	144	1.7	6.2	34	700	1,500
Z045	196	1.7	7.4	52	2,200	1,500
Z025	288	1.7	9.6	79	2,500	1,500

MICROCABLES 200µm

Specification: Z436, Z437, Z022



Outdoor



FTTx



Halogen free



Air blown



Duct



High count

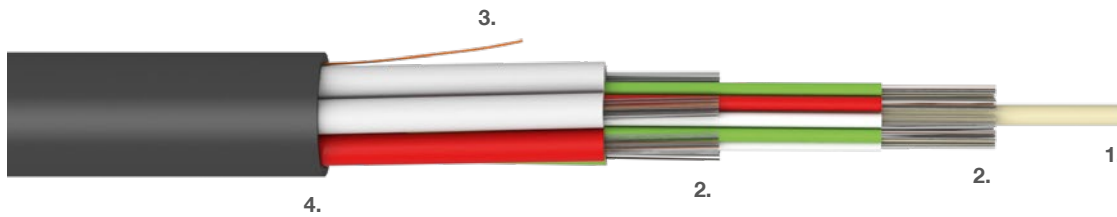

Description of materials:

1. FRP dielectric central strength member.
2. Gel filled PBT loose tube with up to 24 200µm optical fibers.
3. Rip-Cord.
4. PE outer jacket, UV stable.

Temperature range

Installation	-15 to +50 °C
Operation	-30 to +70 °C
Storage	-40 to +70 °C

Design code	Max. fiber count	Loose tube diameter [mm]	Cable size [mm]	Cable weight [kg/km]	Max. load (installation) [N]	Crush resistance [N/10 cm]
NEW Z436	432	1.7	9.8	81	500	500
NEW Z437	576	1.7	11.4	109	800	500
NEW Z022	864	1.7	14.4	165	700	1,000

MLT STANDARD

Specification: Z022, Z304



Indoor



Outdoor



Halogen free



Air blown



Duct



High count

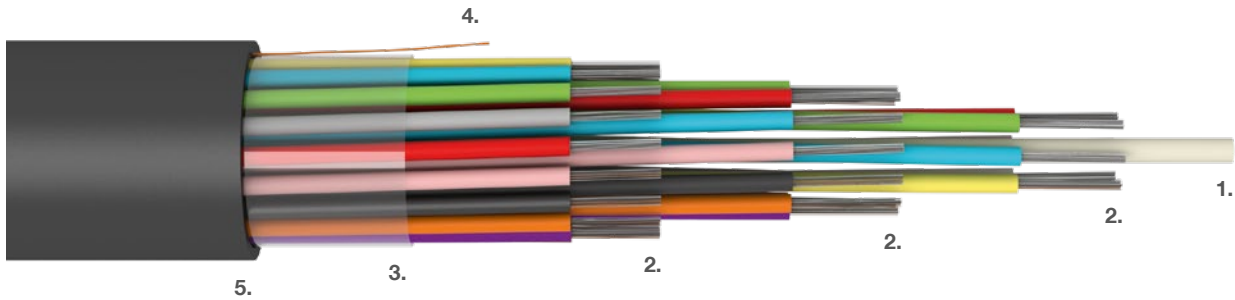

Description of materials:

- 1.** FRP dielectric central strength member. **2.** Gel filled PBT loose tube with optical fibres.
3. Water-swellable tape. **4.** Rip-Cord. **5.** FR-LSZH or PE outer jacket, UV stable.

Temperature range

Installation -15 to +50 °C

Operation -40 to +70 °C

Storage -40 to +70 °C

Design code	Max. fiber count	Loose tube diameter [mm]	Cable size [mm]	Cable weight [kg/km]	Max. load (installation) [N]	Crush resistance [N/10 cm]
Z022	432	1.7	14.4	157	700	1,000
Z304	432	1.7	15.4	216	700	1,000

MLT STANDARD

Specification: Z349, Z350

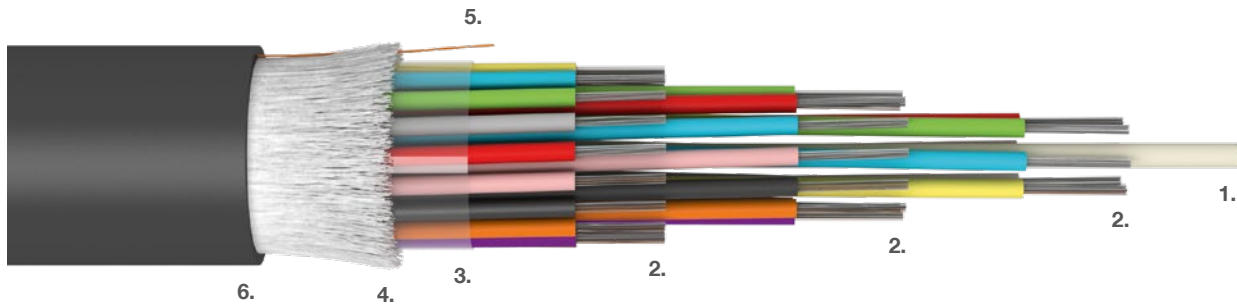
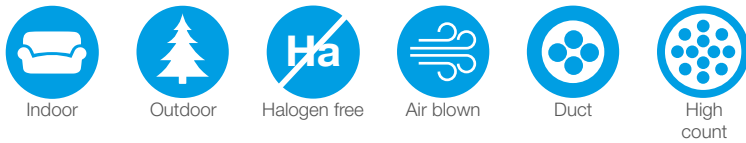

Description of materials:

- 1. FRP dielectric central strength member. 2. Gel filled PBT loose tube with optical fibers.
- 3. Water-swellable tape. 4. Waterblocking E-glass yarn. 5. Rip-Cord. 6. FR-LSZH or PE outer jacket, UV stable.

Temperature range

Installation	-15 to +50 °C
Operation	-30 to +70 °C
Storage	-30 to +70 °C

Design code	Max. fiber count	Loose tube diameter [mm]	Cable size [mm]	Cable weight [kg/km]	Max. load (installation) [N]	Crush resistance [N/10 cm]
Z349	864	2.5	21.7	353	4,500	2,000
Z350	864	2.5	21.7	407	4,500	2,000



MLT STANDARD

Specification: UE01, UE02, CE01, CE02, PE01, PE02, RE01, RE02, VE01, VE02



Indoor



Outdoor



Halogen free



FTTx



Duct

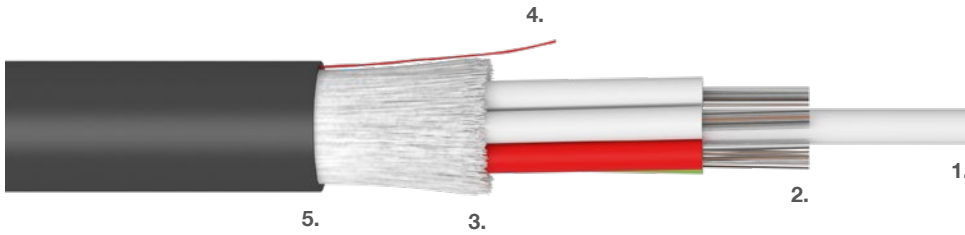

Description of materials:

- 1.** FRP dielectric central strength member. **2.** Gel filled PBT loose tube with optical fibers.
3. Waterblocking E-glass yarn. **4.** Rip-Cord. **5.** FR-LSZH or PE outer jacket, UV stable.

Temperature range

Installation -15 to +50 °C

Operation -40 to +70 °C

Storage -40 to +70 °C

Design code	Max. fiber count	Loose tube diameter [mm]	Cable size [mm]	Cable weight [kg/km]	Max. load (installation) [N]	Crush resistance [N/10 cm]
UE01	60	1.7	7.9	56	1,300	3,000
UE02	60	1.7	7.9	72	1,300	3,000
CE01	72	1.7	8.4	65	2,000	3,000
CE02	72	1.7	8.4	83	2,000	3,000
PE01	96	1.7	9.5	87	4,300	3,000
PE02	96	1.7	9.5	107	4,300	3,000
RE01	144	1.7	11.8	125	7,300	3,000
RE02	144	1.7	11.8	151	7,300	3,000
VE01	216	1.7	11.9	116	2,200	2,000
VE02	216	1.7	11.9	145	2,200	2,000

MLT STANDARD

Specification: LE01, LE02, FE01, FE02, GE01, GE02, HE01, HE02, IE00, IE02



Indoor



Outdoor



Halogen free



FTTx



Duct

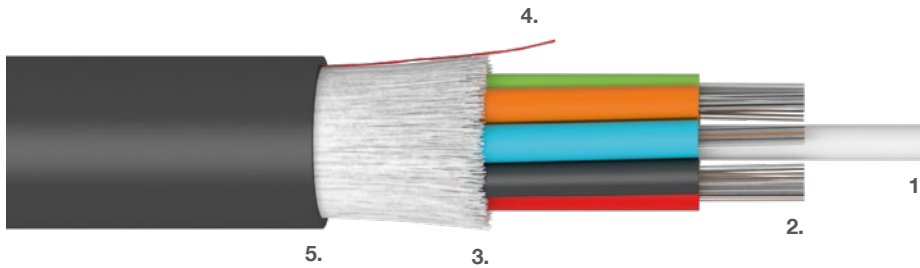

Description of materials:

- 1.** FRP dielectric central strength member. **2.** Gel filled PBT loose tube with optical fibers.
3. Waterblocking E-glass yarn. **4.** Rip-Cord. **5.** FR-LSZH or PE outer jacket, UV stable.

Temperature range

Installation	-15 to +50 °C
Operation	-40 to +70 °C
Storage	-40 to +70 °C

Design code	Max. fiber count	Loose tube diameter [mm]	Cable size [mm]	Cable weight [kg/km]	Max. load (installation) [N]	Crush resistance [N/10 cm]
LE01	48	2.3	8.9	63	1,400	2,000
LE02	48	2.3	8.9	83	1,400	2,000
FE01	72	2.3	10.6	89	2,400	2,000
FE02	72	2.3	10.6	113	2,400	2,000
GE01	96	2.3	11.9	113	3,400	2,000
GE02	96	2.3	11.9	140	3,400	2,000
HE01	144	2.3	14.8	170	5,500	2,000
HE02	144	2.3	14.8	206	5,500	2,000
IE00	216	2.3	15.6	186	3,300	2,000
IE02	216	2.3	15.6	223	3,300	2,000

MLT STANDARD

Specification: Z438



Indoor



Outdoor



FTTx



Duct

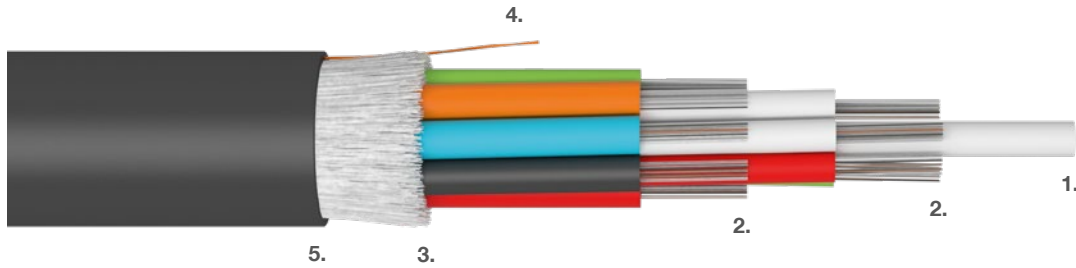

Description of materials:

- 1.** FRP dielectric central strength member. **2.** Gel filled PBT loose tube with optical fibers.
3. Waterblocking E-glass yarn. **4.** Rip-Cord. **5.** PE outer jacket, UV stable.

Temperature range

Installation	-15 to +50 °C
Operation	-20 to +70 °C
Storage	-20 to +70 °C

Design code	Max. fiber count	Loose tube diameter [mm]	Cable size [mm]	Cable weight [kg/km]	Max. load (installation) [N]	Crush resistance [N/10 cm]
NEW Z438	288	1.7	13.2	144	3,200	1,000

MLT STANDARD

Specification: Z090, Z182



Indoor



Outdoor



Halogen free



FTTx



Duct

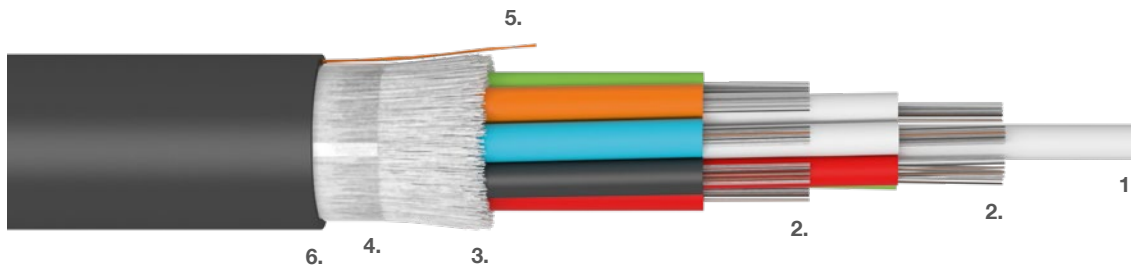

Description of materials:

1. FRP dielectric central strength member.
2. Gel filled PBT loose tube with optical fibers.
3. Waterblocking E-glass yarn.
4. Water-swallowable tape.
5. Rip-Cord.
6. FR-LSZH or PE outer jacket, UV stable.

Temperature range

Installation	-15 to +50 °C
Operation	-40 to +70 °C
Storage	-40 to +70 °C

Design code	Max. fiber count	Loose tube diameter [mm]	Cable size [mm]	Cable weight [kg/km]	Max. load (installation) [N]	Crush resistance [N/10 cm]
Z090	288	2.3	17.7	234	5,500	2,000
Z182	288	2.3	17.7	276	5,500	2,000

MLT STANDARD

Specification: DE01, DE02, KE01, KE02, SE01, SE02



Indoor



Outdoor



Halogen free



Air blown



Duct



High count

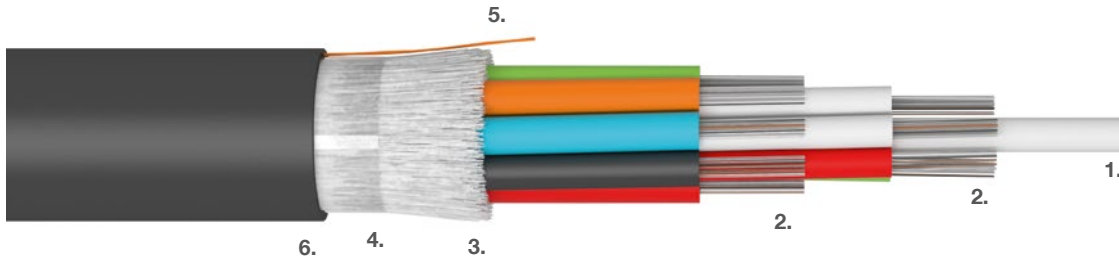

Description of materials:

1. FRP dielectric central strength member. 2. Gel filled PBT loose tube with optical fibers.
3. Waterblocking E-glass yarn. 4. Water-swellaable tape. 5. Rip-Cord. 6. FR-LSZH or PE outer jacket, UV stable.

Temperature range

Installation	-15 to +50 °C
Operation	-30 to +70 °C
Storage	-40 to +70 °C

Design code	Max. fiber count	Loose tube diameter [mm]	Cable size [mm]	Cable weight [kg/km]	Max. load (installation) [N]	Crush resistance [N/10 cm]
DE01	144	2.5	11.7	73	2,000	1,500
DE02	144	2.5	11.7	102	2,000	1,500
KE01	192	2.5	13.1	98	3,200	1,500
KE02	192	2.5	13.1	132	3,200	1,500
SE01	288	2.5	16.2	157	5,200	1,500
SE02	288	2.5	16.2	201	5,200	1,500

MLT IMPROVED

Specification: CR01, CR02, PR01, PR02, RR01, RR02, VR01, VR02

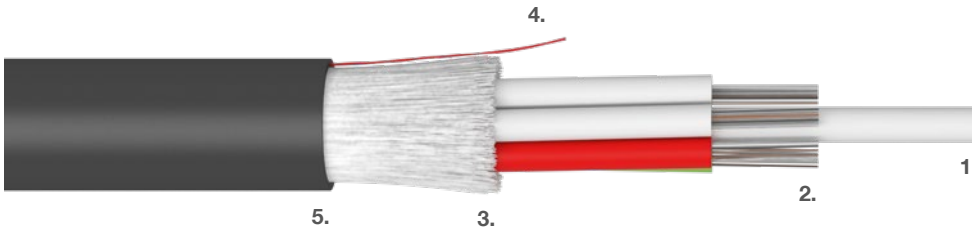

Description of materials:

- 1. FRP dielectric central strength member. 2. Gel filled PBT loose tube with optical fibers.
- 3. Waterblocking E-glass yarn. 4. Rip-Cord. 5. FR-LSZH or PE outer jacket, UV stable.

Temperature range

Installation	-15 to +50 °C
Operation	-40 to +70 °C
Storage	-40 to +70 °C

Design code	Max. fiber count	Loose tube diameter [mm]	Cable size [mm]	Cable weight [kg/km]	Max. load (installation) [N]	Crush resistance [N/10 cm]
CR01	72	1.7	9.4	81	4,600	3,000
CR02	72	1.7	9.4	101	4,600	3,000
PR01	96	1.7	10.8	108	8,000	3,000
PR02	96	1.7	10.8	132	8,000	3,000
RR01	144	1.7	12.8	150	13,000	3,000
RR02	144	1.7	12.8	179	13,000	3,000
VR01	216	1.7	12.1	133	5,100	2,000
VR02	216	1.7	12.1	161	5,100	2,000



MLT IMPROVED

Specification: LR01, LR02, FR01, FR02, GR01, GR02, HR01, HR02



Indoor



Outdoor



Halogen free



FTTx



Duct



High tensile

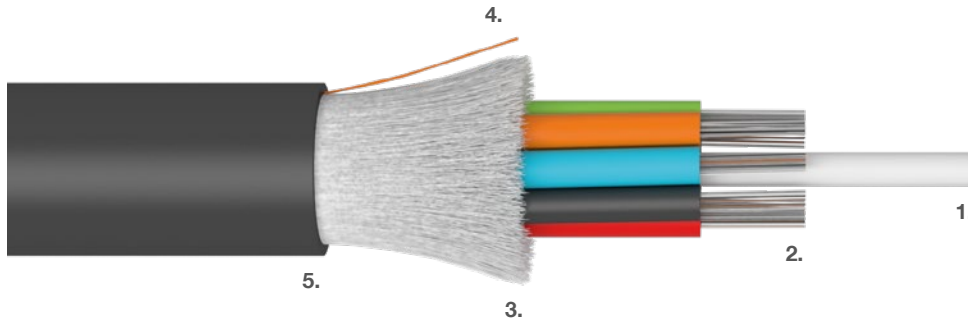

Description of materials:

- 1.** FRP dielectric central strength member. **2.** Gel filled PBT loose tube with optical fibers.
3. Waterblocking E-glass yarn. **4.** Rip-Cord. **5.** FR-LSZH or PE outer jacket, UV stable.

Temperature range

Installation -15 to +50 °C

Operation -40 to +70 °C

Storage -40 to +70 °C

Design code	Max. fiber count	Loose tube diameter [mm]	Cable size [mm]	Cable weight [kg/km]	Max. load (installation) [N]	Crush resistance [N/10 cm]
LR01	48	2.3	9.2	74	2,600	2,000
LR02	48	2.3	9.2	95	2,600	2,000
FR01	72	2.3	10.6	99	4,000	2,000
FR02	72	2.3	10.6	122	4,000	2,000
GR01	96	2.3	12.0	131	7,000	2,000
GR02	96	2.3	12.0	158	7,000	2,000
HR01	144	2.3	14.9	197	10,000	2,000
HR02	144	2.3	14.9	231	10,000	2,000

MLT IMPROVED

Specification: IR01, IR02



Indoor



Outdoor



Halogen free



FTTx



Duct



High tensile

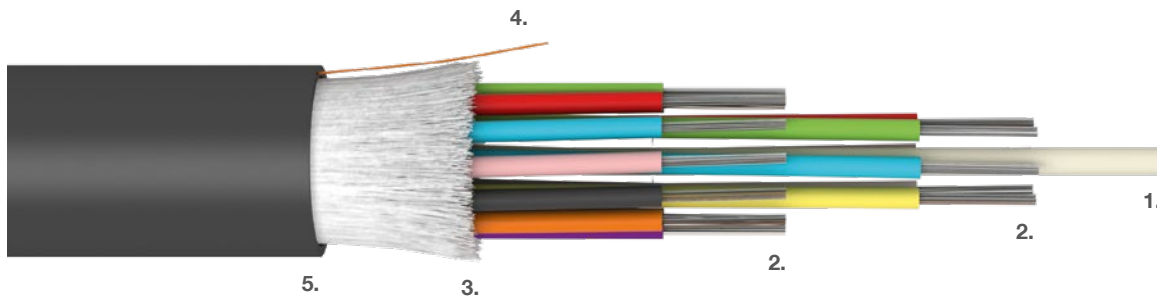

Description of materials:

1. FRP dielectric central strength member.
2. Gel filled PBT loose tube with optical fibers.
3. Waterblocking E-glass yarn.
4. Rip-Cord.
5. FR-LSZH or PE outer jacket, UV stable.

Temperature range

Installation	-15 to +50 °C
Operation	-40 to +70 °C
Storage	-40 to +70 °C

Design code	Max. fiber count	Loose tube diameter [mm]	Cable size [mm]	Cable weight [kg/km]	Max. load (installation) [N]	Crush resistance [N/10 cm]
IR01	216	2.3	15.8	221	6,700	2,000
IR02	216	2.3	15.8	258	6,700	2,000

MLT CST

Specification: CH01, CH02, PH01, PH02, RH01, RH02



Indoor



Outdoor



Halogen free



Armoured



Direct burial



Antirodent

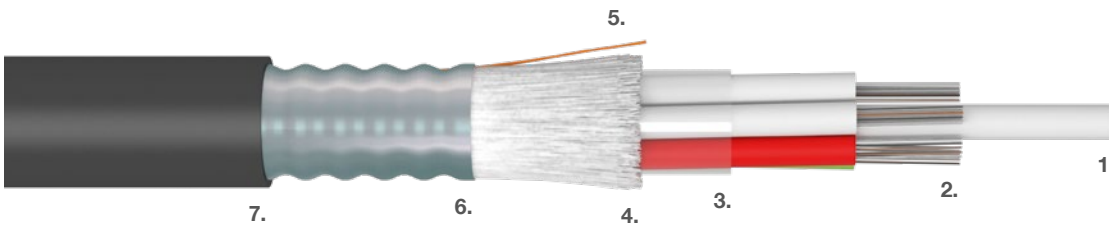

Description of materials:

1. FRP dielectric central strength member.
2. Gel filled PBT loose tube with optical fibers.
3. Water-swellable tape.
4. Waterblocking E-glass yarn.
5. Rip-Cord.
6. Corrugated steel tape.
7. FR-LSZH or PE outer jacket, UV stable.

Temperature range

Installation	-15 to +50 °C
Operation	-40 to +70 °C
Storage	-40 to +70 °C

Design code	Max. fiber count	Loose tube diameter [mm]	Cable size [mm]	Cable weight [kg/km]	Max. load (installation) [N]	Crush resistance [N/10 cm]
CH01	72	1.7	10.2	107	2,600	10,000
CH02	72	1.7	10.2	126	2,600	10,000
PH01	96	1.7	11.1	130	5,400	10,000
PH02	96	1.7	11.1	152	5,400	10,000
RH01	144	1.7	14.1	186	6,600	10,000
RH02	144	1.7	14.1	214	6,600	10,000

MLT CST

Specification: LH01, LH02, FH01, FH02, GH01, GH02, HH01, HH02



Indoor



Outdoor



Halogen free



Armoured



Direct burial



Antirodent

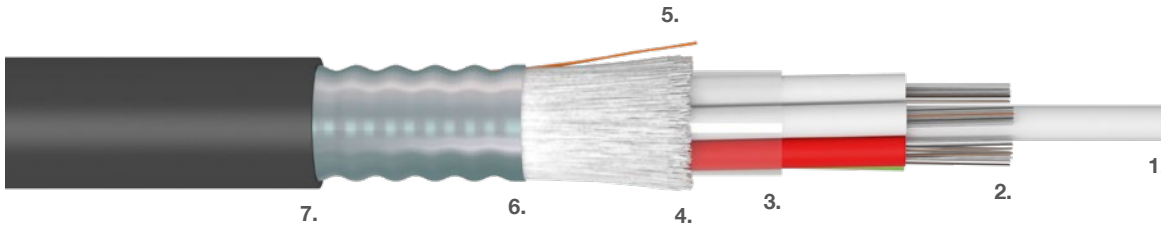

Description of materials:

1. FRP dielectric central strength member.
2. Gel filled PBT loose tube with optical fibers.
3. Water-swellable tape.
4. Waterblocking E-glass yarn.
5. Rip-Cord.
6. Corrugated steel tape.
7. FR-LSZH or PE outer jacket, UV stable.

Temperature range

Installation	-15 to +50 °C
Operation	-40 to +70 °C
Storage	-40 to +70 °C

Design code	Max. fiber count	Loose tube diameter [mm]	Cable size [mm]	Cable weight [kg/km]	Max. load (installation) [N]	Crush resistance [N/10 cm]
LH01	48	2.3	11.5	125	1,200	10,000
LH02	48	2.3	11.5	151	1,200	10,000
FH01	72	2.3	12.5	150	2,100	10,000
FH02	72	2.3	12.5	178	2,100	10,000
GH01	96	2.3	14.5	185	2,600	10,000
GH02	96	2.3	14.5	219	2,600	10,000
HH01	144	2.3	16.5	250	4,500	10,000
HH02	144	2.3	16.5	288	4,500	10,000

MLT CST

Specification: VH01, VH02



Indoor



Outdoor



Halogen free



Armoured



Direct burial



Antirodent

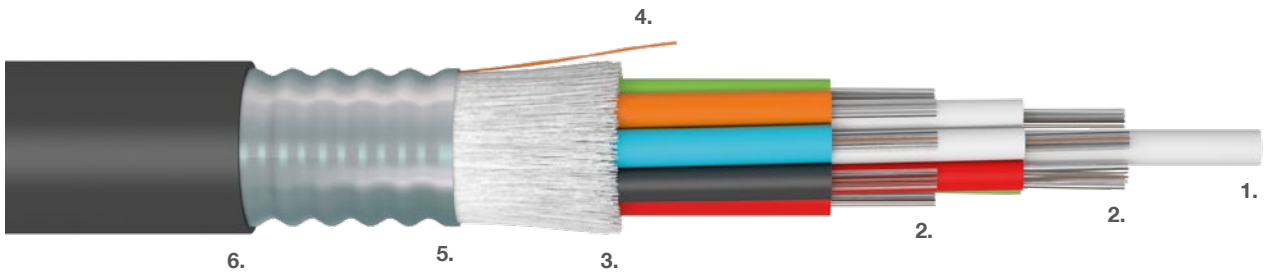

Description of materials:

- 1.** FRP dielectric central strength member. **2.** Gel filled PBT loose tube with optical fibers.
3. Waterblocking E-glass yarn. **4.** Rip-Cord. **5.** Corrugated steel tape. **6.** FR-LSZH or PE outer jacket, UV stable.

Temperature range

Installation -15 to +50 °C

Operation -45 to +70 °C

Storage -45 to +70 °C

Design code	Max. fiber count	Loose tube diameter [mm]	Cable size [mm]	Cable weight [kg/km]	Max. load (installation) [N]	Crush resistance [N/10 cm]
VH01	216	1.7	14.5	193	3,000	10,000
VH02	216	1.7	14.5	228	3,000	10,000

MLT CST DOUBLE JACKET

Specification: LIPI, LIP2, LIF2, FIPI, FIP2, FIF2



Indoor



Outdoor



Halogen free



Armoured



Direct burial



Antirodent

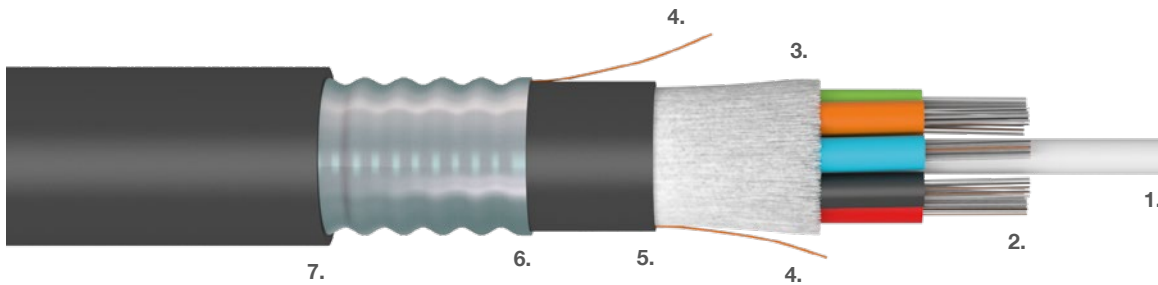

Description of materials:

1. FRP dielectric central strength member.
2. Gel filled PBT loose tube with optical fibers.
3. Waterblocking E-glass yarn.
4. Rip-Cord.
5. FR-LSZH or PE inner jacket.
6. Corrugated steel tape.
7. FR-LSZH or PE outer jacket, UV stable.

Temperature range

Installation	-15 to +50 °C
Operation	-45 to +70 °C
Storage	-45 to +70 °C

Design code	Max. fiber count	Loose tube diameter [mm]	Cable size [mm]	Cable weight [kg/km]	Max. load (installation) [N]	Crush resistance [N/10 cm]
LIPI	48	2.3	13.5	165	1,500	10,000
LIP2	48	2.3	13.5	196	1,500	10,000
LIF2	48	2.3	13.5	209	1,500	10,000
FIPI	72	2.3	14.5	197	3,300	10,000
FIP2	72	2.3	14.5	230	3,300	10,000
FIF2	72	2.3	14.5	246	3,300	10,000

MLT CST DOUBLE JACKET

Specification: GIPI, GIF2, HIPI, HIF2



Indoor



Outdoor



Halogen free



Armoured



Direct burial



Antirodent

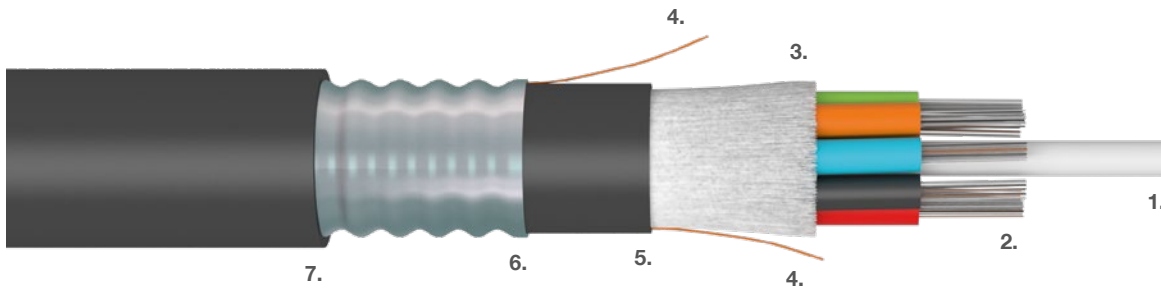

Description of materials:

1. FRP dielectric central strength member.
2. Gel filled PBT loose tube with optical fibers.
3. Waterblocking E-glass yarn.
4. Rip-Cord.
5. FR-LSZH or PE inner jacket.
6. Corrugated steel tape.
7. FR-LSZH or PE outer jacket, UV stable.

Temperature range

Installation	-15 to +50 °C
Operation	-45 to +70 °C
Storage	-45 to +70 °C

Design code	Max. fiber count	Loose tube diameter [mm]	Cable size [mm]	Cable weight [kg/km]	Max. load (installation) [N]	Crush resistance [N/10 cm]
GIPI	96	2.3	16.5	240	4,800	10,000
GIF2	96	2.3	16.5	295	4,800	10,000
HIPI	144	2.3	19.5	323	10,000	10,000
HIF2	144	2.3	19.5	391	10,000	10,000

MLT SWA

Specification: LWPI, LWF2, FWPI, FWF2, GWPI, GWF2, HWPI, HWF2



Indoor



Outdoor



Halogen free



Armoured



Direct burial



High tensile

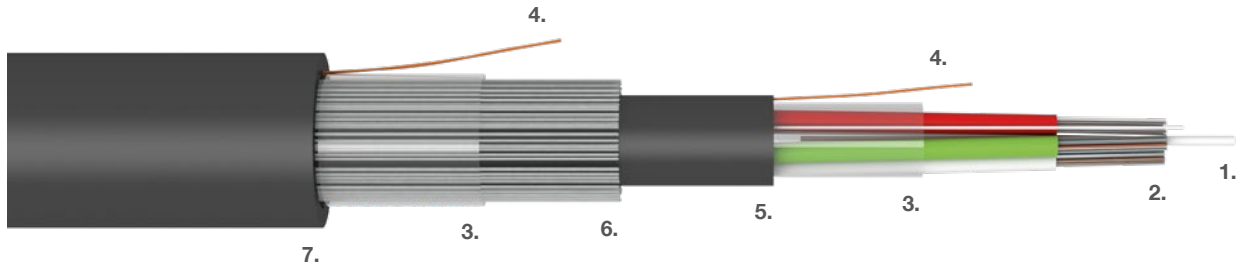

Description of materials:

1. FRP dielectric central strength member.
2. Gel filled PBT loose tube with optical fibers.
3. Water-swellable tape.
4. Rip-Cord.
5. FR-LSZH or PE inner jacket.
6. Steel Wire Armour (SWA).
7. FR-LSZH or PE outer jacket, UV stable.

Temperature range

Installation	-15 to +50 °C
Operation	-40 to +70 °C
Storage	-40 to +70 °C

Design code	Max. fiber count	Loose tube diameter [mm]	Cable size [mm]	Cable weight [kg/km]	Max. load (installation) [N]	Crush resistance [N/10 cm]
LWPI	48	2.3	13.2	278	1,900	4,500
LWF2	48	2.3	13.2	317	1,900	4,500
FWPI	72	2.3	14.7	334	4,200	4,500
FWF2	72	2.3	14.7	380	4,200	4,500
GWPI	96	2.3	16.0	392	5,500	4,500
GWF2	96	2.3	16.0	443	5,500	4,500
HWPI	144	2.3	18.9	516	9,700	4,500
HWF2	144	2.3	18.9	579	9,700	4,500

ADSS

Specification: AS01, Z159, Z194



Outdoor



Dielectric



Aerial

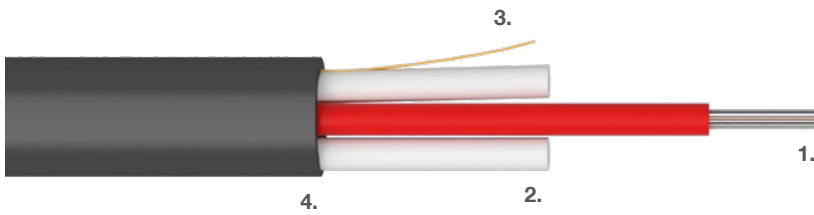

Description of materials:

- 1.** Gel filled PBT loose tube with optical fibers. **2.** FRP periferal strength member.
3. Rip-Cord. **4.** PE outer jacket, UV stable.

Temperature range

Installation -15 to +50 °C

Operation -40 to +70 °C

Storage -40 to +70 °C

Design code	Max. fiber count	Loose tube diameter [mm]	Cable size [mm]	Cable weight [kg/km]	Max. load (installation) [N]	Crush resistance [N/10 cm]
AS01	12	2.0	4.2 × 7.8	37	1,600	4,000
Z159	24	1.7	9.1 × 3.8	36	1,300	4,000
Z194	48	3.5	12.5 × 5.5	72	2,500	2,500

ADSS – Light 2.6 kN

Specification: N3HI, N4HI, N5HI, N6HI



Outdoor



Duct



Dielectric



Aerial

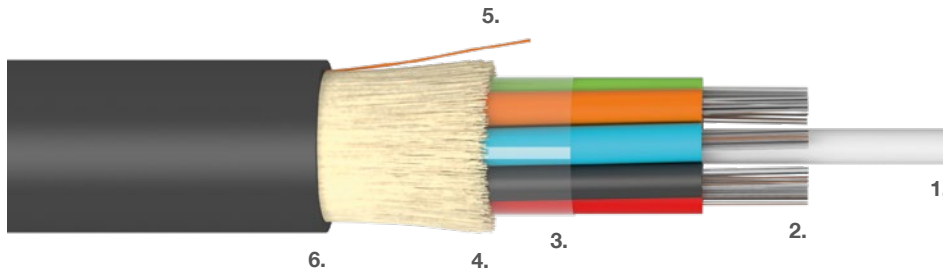

Description of materials:

1. FRP dielectric central strength member.
2. Gel filled PBT loose tube with optical fibers.
3. Water-swellable tape.
4. Waterblocking aramid yarn.
5. Rip-Cord.
6. PE outer jacket, UV stable.

Temperature range

Installation	-15 to +50 °C
Operation	-40 to +70 °C
Storage	-40 to +70 °C

Design code	Max. fiber count	Loose tube diameter [mm]	Cable size [mm]	Cable weight [kg/km]	Max. load (installation) [N]	Crush resistance [N/10 cm]
NEW N3HI	48	2.0	8.9	63	2,600	1,500
NEW N4HI	72	2.0	9.8	80	3,000	1,500
NEW N5HI	96	2.0	11.2	100	3,000	1,500
NEW N6HI	144	2.0	13.6	145	3,000	1,500

ADSS 3 kN

Specification: N3XI, N4XI, N5XI, N6XI



Outdoor



Duct



Dielectric



Aerial

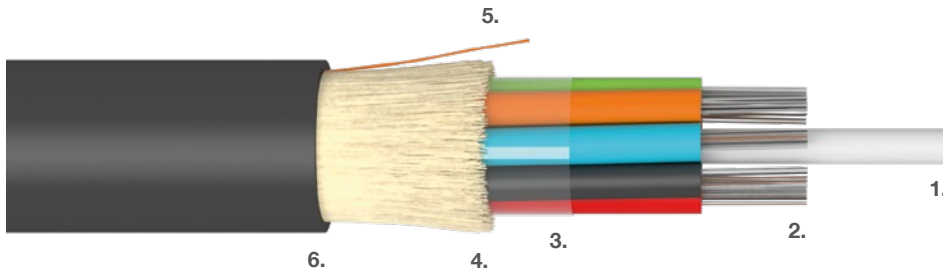

Description of materials:

- 1.** FRP dielectric central strength member. **2.** Gel filled PBT loose tube with optical fibers.
3. Water-swellable tape. **4.** Waterblocking aramid yarn. **5.** Rip-Cord. **6.** PE outer jacket, UV stable.

Temperature range

Installation -15 to +50 °C

Operation -40 to +70 °C

Storage -40 to +70 °C

Design code	Max. fiber count	Loose tube diameter [mm]	Cable size [mm]	Cable weight [kg/km]	Max. load (installation) [N]	Crush resistance [N/10 cm]
N3XI	48	2.5	10.2	79	3,000	3,000
N4XI	72	2.5	11.9	110	3,000	3,000
N5XI	96	2.5	13.3	133	3,000	3,000
N6XI	144	2.5	16.4	200	3,000	3,000

ADSS 6 kN

Specification: N3YI, N4YI, N5YI, N6YI



Outdoor



Duct



Dielectric



Aerial

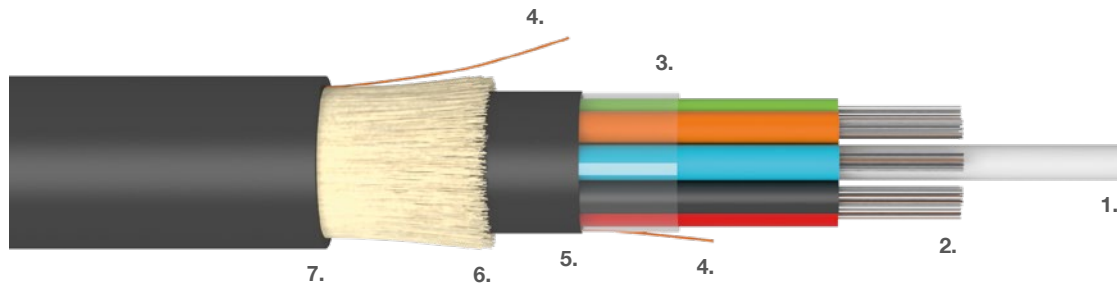

Description of materials:

1. FRP dielectric central strenght member.
2. Gel filled PBT loose tube with optical fibers.
3. Water-swellable tape.
4. Rip-Cord.
5. PE inner jacket.
6. Waterblocking aramid yarn.
7. PE outer jacket, UV stable.

Temperature range

Installation	-15 to +50 °C
Operation	-40 to +70 °C
Storage	-40 to +70 °C

Design code	Max. fiber count	Loose tube diameter [mm]	Cable size [mm]	Cable weight [kg/km]	Max. load (installation) [N]	Crush resistance [N/10 cm]
N3YI	48	2.5	12.2	115	6,000	3,000
N4YI	72	2.5	13.8	149	6,000	3,000
N5YI	96	2.5	15.3	178	6,000	3,000
N6YI	144	2.5	18.4	255	6,000	3,000

ADSS 10 kN

Specification: N4ZI, N5ZI, N6ZI, N9ZI



Outdoor



Duct



Dielectric



Aerial



High tensile

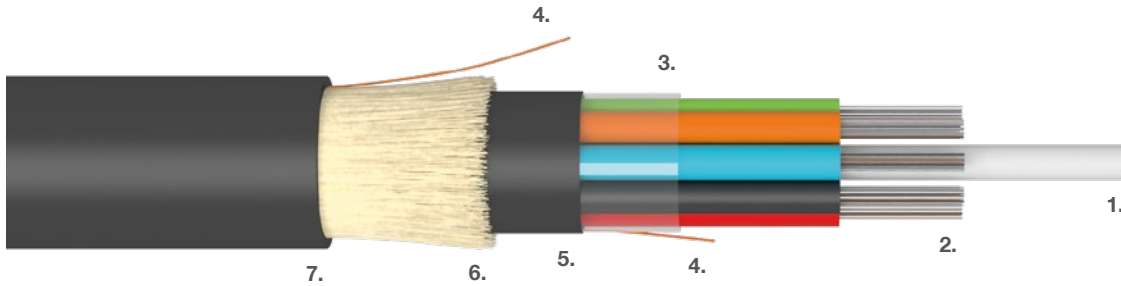

Description of materials:

1. FRP dielectric central strength member. **2.** Gel filled PBT loose tube with optical fibers. **3.** Water-swellable tape. **4.** Rip-Cord. **5.** PE inner jacket. **6.** Waterblocking aramid yarn. **7.** PE outer jacket, UV stable.

Temperature range

Installation	-15 to +50 °C
Operation	-40 to +70 °C
Storage	-40 to +70 °C

Design code	Max. fiber count	Loose tube diameter [mm]	Cable size [mm]	Cable weight [kg/km]	Max. load (installation) [N]	Crush resistance [N/10 cm]
N4ZI	72	2.8	15.5	192	10,000	3,000
N5ZI	96	2.8	17	221	10,000	3,000
N6ZI	144	2.8	20.5	312	10,000	3,000
N9ZI	288	2.5	22.5	367	10,000	3,000

ADSS 15 kN

Specification: N4RI, N5RI, N6RI, N7RI, N7SI



Outdoor



Duct



Dielectric



Aerial



High tensile

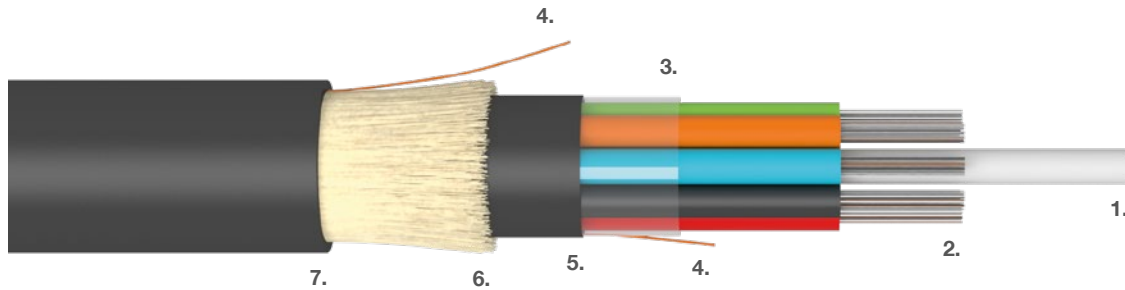

Description of materials:

1. FRP dielectric central strength member. **2.** Gel filled PBT loose tube with optical fibers. **3.** Water-swellable tape. **4.** Rip-Cord. **5.** PE inner jacket. **6.** Waterblocking aramid yarn. **7.** PE outer jacket, UV stable.

Temperature range

Installation	-15 to +50 °C
Operation	-40 to +70 °C
Storage	-40 to +70 °C

Design code	Max. fiber count	Loose tube diameter [mm]	Cable size [mm]	Cable weight [kg/km]	Max. load (installation) [N]	Crush resistance [N/10 cm]
N4RI	72	2.8	15.6	200	15,000	3,000
N5RI	96	2.8	17.3	236	15,000	3,000
N6RI	144	2.8	20.9	341	15,000	3,000
N7RI	216	2.8	21.2	343	15,000	3,000
N7SI	216	2.8	19.0	281	15,000	3,000

FIG.8

Specification: A860, A862, Z187



Indoor



Outdoor



Halogen free



Aerial

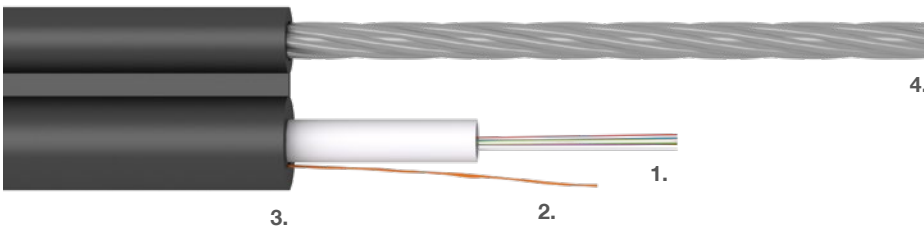

Description of materials:

1. Gel filled PBT loose tube with optical fibers.
2. Rip-Cord.
3. FR-LSZH or PE outer jacket, UV stable.
4. Steel wire messenger.

Temperature range

Installation	-15 to +50 °C
Operation	-30 to +70 °C
Storage	-30 to +70 °C

Design code	Max. fiber count	Loose tube diameter [mm]	Cable size [mm]	Cable weight [kg/km]	Max. load (installation) [N]	Crush resistance [N/10 cm]
A860	12	2.3	5.9 × 11.5	55	1,000	1,000
A862	12	2.3	5.9 × 11.5	78	1,000	1,000
Z187	24	4.5	8.5 × 18.0	140	3,000	2,000

FIG.8

Specification: L83A, F83A, G83A, H83A



Outdoor



Halogen free



Aerial

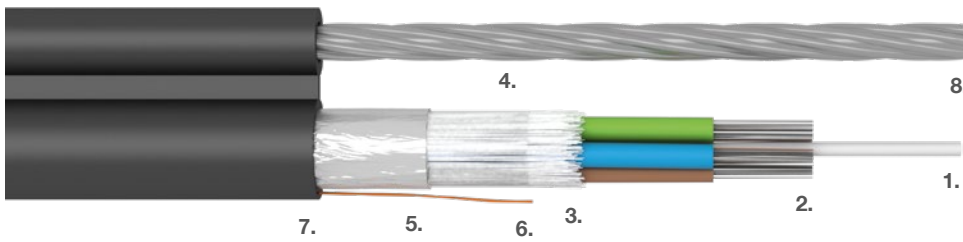

Description of materials:

1. FRP dielectric central strength member.
2. Gel filled PBT loose tube with optical fibers.
3. Waterblocking E-glass yarn.
4. Water-swollable tape.
5. Moisture barrier.
6. Rip-Cord.
7. PE outer jacket, UV stable.
8. Steel wire messenger.

Temperature range

Installation	-15 to +50 °C
Operation	-30 to +70 °C
Storage	-30 to +70 °C

Design code	Max. fiber count	Loose tube diameter [mm]	Cable size [mm]	Cable weight [kg/km]	Max. load (installation) [N]	Crush resistance [N/10 cm]
L83A	48	2.3	11.1 × 20.7	162	5,000	2,000
F83A	72	2.3	13.1 × 22.7	192	5,000	2,000
G83A	96	2.3	14.1 × 23.7	219	5,000	2,000
H83A	144	2.3	17.1 × 26.7	285	5,000	2,000



K 307

5. SPECIAL CABLES

- FIRE RESISTANT 🔥
- CPR 🔥
- HYBRID
- UNDERWATER
- ARMoured MICRODUCT
- FLES TUBE
- TRACER WIRE

FIRE RESISTANT – FSC 90 min.

Specification: CLT – Z297; MLT – Z298, Z299, Z300



Indoor



Outdoor



Halogen free



Armoured



Duct



Fire resistant



Antiodent

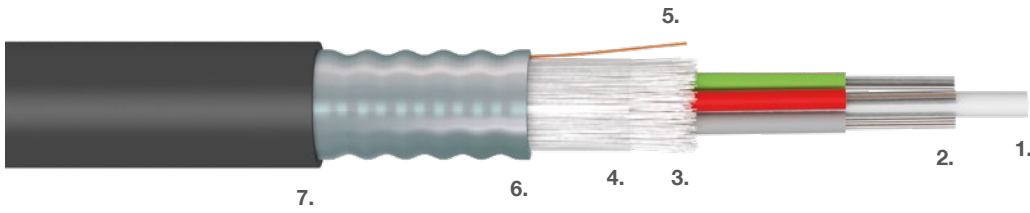

Description of materials:

1. FRP dielectric central strength member. 2. Gel filled PBT loose tube with optical fibers.
3. Waterblocking E-glass yarn. 4. Water-swellable tape. 5. Rip-Cord. 6. Corrugated steel tape.
7. FR-LSZH outer jacket, UV stable.

Temperature range	Z297	Z298, Z299, Z300
Installation	-15 to +50 °C	-15 to +50 °C
Operation	-30 to +70 °C	-40 to +70 °C
Storage	-30 to +70 °C	-40 to +70 °C

Design code	Max. fiber count	Loose tube diameter [mm]	Cable size [mm]	Cable weight [kg/km]	Max. load (installation) [N]	Crush resistance [N/10 cm]
Z297	24	3.0	8.9	108	1,500	10,000
Z298	72	1.7	12.1	171	3,000	10,000
Z299	96	1.7	13.1	203	6,000	10,000
Z300	144	1.7	15.1	272	12,000	10,000

FIRE RESISTANT – FSC 180 min.

Specification: CLT – Z281; Z285 – distribution cable; MLT – Z282, Z283, Z284

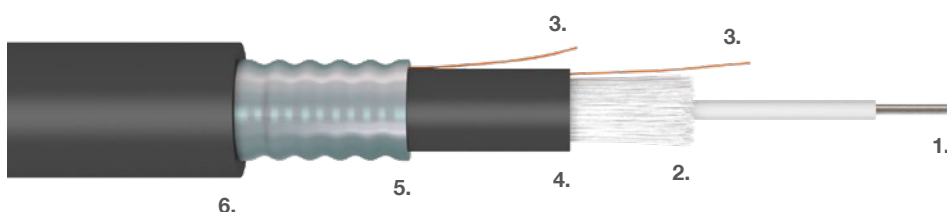

Description of materials:

- 1.** Gel filled PBT loose tube with optical fibers. **2.** Waterblocking E-glass yarn. **3.** Rip-Cord.
4. FR-LSZH inner jacket, UV stable. **5.** Corrugated steel tape. **6.** FR-LSZH outer jacket, UV stable.

Temperature range	Z281	Z285	Z282, Z283, Z284
Installation	-15 to +50 °C	-15 to +50 °C	-15 to +50 °C
Operation	-30 to +80 °C	-20 to +80 °C	-40 to +80 °C
Storage	-40 to +80 °C	-20 to +80 °C	-40 to +80 °C

Design code	Max. fiber count	Loose tube diameter [mm]	Cable size [mm]	Cable weight [kg/km]	Max. load (installation) [N]	Crush resistance [N/10 cm]
Z281	24	3.2	12.5	201	2,000	10,000
Z285	24	0.9 – buffer	17.5	332	3,000	8,000
Z282	72	1.7	14.5	260	2,900	10,000
Z283	96	1.7	15.5	301	5,700	10,000
Z284	144	1.7	17.5	382	10,200	10,000

CPR – Duplex

Specification: ZNx0 Classification CPR Cca



Fire resistant



Indoor



FTTx



Halogen free

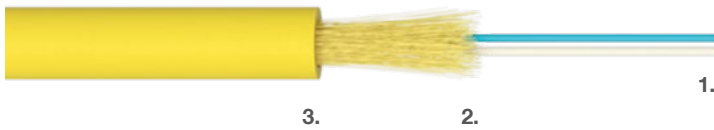

Description of materials:

1. FR-LSZH buffered optical fiber. **2.** Waterblocking aramid yarn. **3.** FR-LSZH outer jacket.

Temperature range

Installation	-5 to +50 °C
Operation	-5 to +50 °C
Storage	-5 to +50 °C

Design code	Fiber count	Cable outer diameter [mm]	Cable weight [kg/km]	Max. load (installation) [N]	Crush resistance [N/10 cm]
NEW ZNx0	2	2.8	8	280	1,000

CPR – DROP

Specification: ZN02 Classification CPR Dca

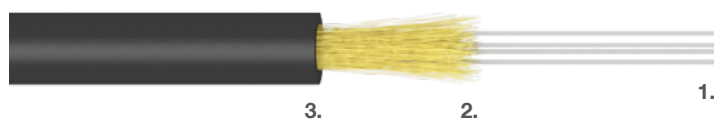

Description of materials:

1. Optical fibers. 2. Aramid yarn. 3. FR-LSZH outer jacket, UV stable.

Temperature range

Installation	-5 to +50 °C
Operation	-20 to +60 °C
Storage	-20 to +60 °C

Design code	Fiber count	Cable outer diameter [mm]	Cable weight [kg/km]	Max. load (installation) [N]	Crush resistance [N/10 cm]
NEW ZN02	24	4.0	16	500	1,000

CPR – CLT

Specification: ZN06 Classification CPR Dca



Fire resistant



Indoor



Outdoor



FTTx



Halogen free

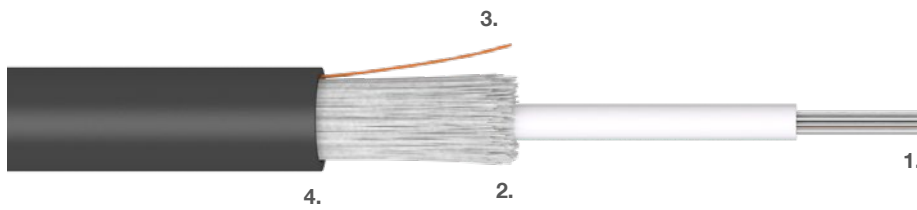

Description of materials:

1. Gel filled PBT loose tube with optical fibers.
2. Waterblocking E-glass yarn.
3. Rip-Cord.
4. FR-LSZH outer jacket, UV stable.

Temperature range

Installation	-15 to +50 °C
Operation	-20 to +70 °C
Storage	-20 to +70 °C

Design code	Max. fiber count	Loose tube diameter [mm]	Cable size [mm]	Cable weight [kg/km]	Max. load (installation) [N]	Crush resistance [N/10 cm]
NEW ZN06	4-12	2.5	5.4	37	1,100	2,000

CPR – CLT

Specification: ZN05 Classification CPR Dca

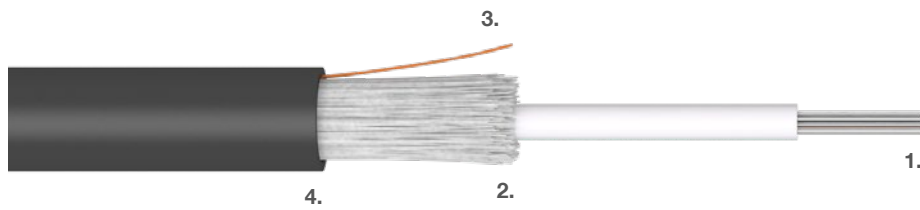

Description of materials:

1. Gel filled PBT loose tube with optical fibers.
2. Waterblocking E-glass yarn.
3. Rip-Cord.
4. FR-LSZH outer jacket, UV stable.

Temperature range

Installation	-15 to +50 °C
Operation	-20 to +70 °C
Storage	-20 to +70 °C

Design code	Fiber count	Loose tube diameter [mm]	Cable size [mm]	Cable weight [kg/km]	Max. load (installation) [N]	Crush resistance [N/10 cm]
NEW ZN05	4-24	3.0	6.4	51	1,100	2,000

CPR – CLT CST

Specification: ZN01 for 12F or 24F Classification CPR B2ca, for 1–24F Classification CPR Cca

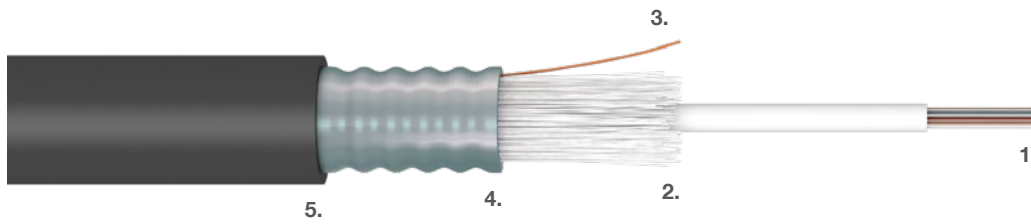

Description of materials:

1. Gel filled PBT loose tube with optical fibers. **2.** Waterblocking E-glass yarn. **3.** Rip-Cord. **4.** Corrugated steel tape. **5.** FR-LSZH outer jacket, UV stable.

Temperature range

Installation	-15 to +50 °C
Operation	-40 to +70 °C
Storage	-40 to +70 °C

Design code	Max. fiber count	Loose tube diameter [mm]	Cable size [mm]	Cable weight [kg/km]	Max. load (installation) [N]	Crush resistance [N/10 cm]
NEW ZN01	1–24	3.0	10.1	124	2,500	5,000

CPR – CLT CST

Specification: ZN07 for 4–24F Classification CPR Dca

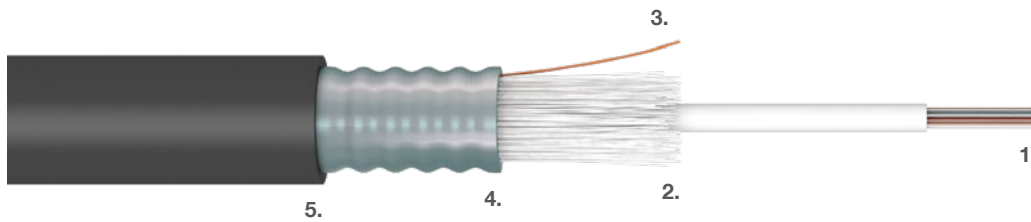

Description of materials:

- 1.** Gel filled PBT loose tube with optical fibers. **2.** Waterblocking E-glass yarn. **3.** Rip-Cord.
4. Corrugated steel tape. **5.** FR-LSZH outer jacket, UV stable.

Temperature range

Installation	-15 to +50 °C
Operation	-20 to +70 °C
Storage	-20 to +70 °C

Design code	Fiber count	Loose tube diameter [mm]	Cable size [mm]	Cable weight [kg/km]	Max. load (installation) [N]	Crush resistance [N/10 cm]
NEW ZN07	4–24	3.0	7.9	90	1,100	3,000

CPR – MLT

Specification: ZN03 for 12 fibers clasificate CPR Cca for 12–72 fibers clasificate CPR Dca

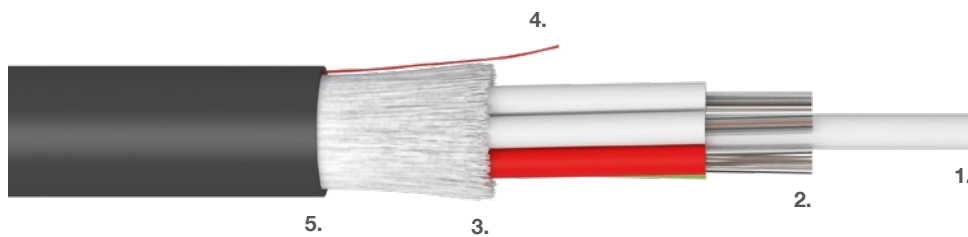

Description of materials:

- 1.** FRP dielectric central strength member. **2.** Gel filled PBT loose tube with optical fibers.
3. Waterblocking E-glass yarn. **4.** Rip-Cord. **5.** FR-LSZH outer jacket, UV stable.

Temperature range

Installation	-15 to +50 °C
Operation	-40 to +70 °C
Storage	-40 to +70 °C

Design code	Max. fiber count	Loose tube diameter [mm]	Cable size [mm]	Cable weight [kg/km]	Max. load (installation) [N]	Crush resistance [N/10 cm]
NEW ZN03	12–48	1.7	7.9	74	1,300	2,000
NEW ZN03	12–72	1.7	8.8	106	2,000	2,000
NEW ZN03	96	1.7	10.0	138	4,300	2,000
NEW ZN03	144	1.7	12.2	184	7,300	2,000

CPR – MLT CST

Specification: ZN04 for 12 fibers clasificate B2ca and a 12-72F Classification CPR Cca

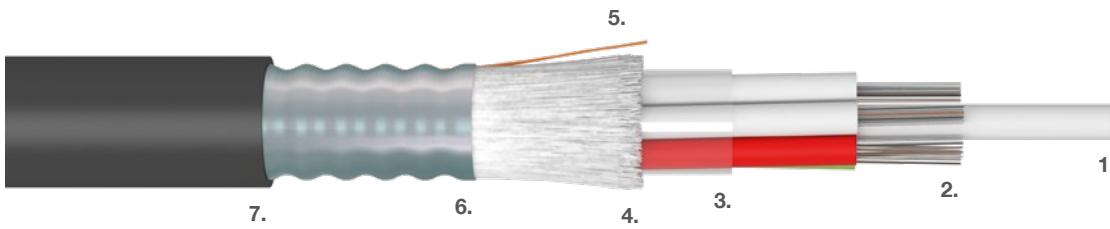

Description of materials:

1. FRP dielectric central strength member.
2. Gel filled PBT loose tube with optical fibers.
3. Water-swellaable tape.
4. Waterblocking E-glass yarn.
5. Rip-Cord.
6. Corrugated steel tape.
7. FR-LSZH or PE outer jacket, UV stable.

Temperature range

Installation	-15 to +50 °C
Operation	-40 to +70 °C
Storage	-40 to +70 °C

Design code	Fiber count	Loose tube diameter [mm]	Cable size [mm]	Cable weight [kg/km]	Max. load (installation) [N]	Crush resistance [N/10 cm]
NEW ZN04	12-48	1.7	10.5	132	1,800	4,000
NEW ZN04	12-72	1.7	10.5	142	1,800	4,000

HYBRID

Specification: Z001



Outdoor



FTTx



Duct

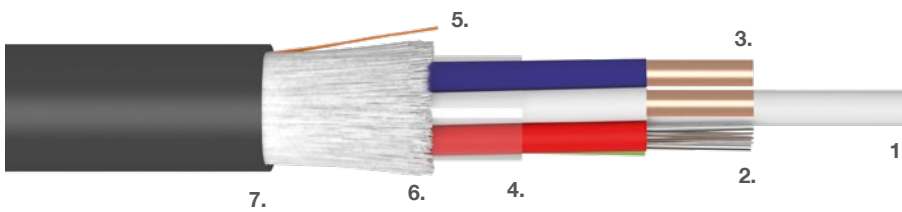

Description of materials:

- 1.** FRP dielectric central strength member. **2.** Gel filled PBT loose tube with optical fibers.
3. Cu pair. **4.** Water-swellable tape. **5.** Rip-Cord. **6.** Waterblocking E-glass yarn. **7.** PE outer jacket UV stabile.

Temperature range

Installation	-15 to +50 °C
Operation	-40 to +70 °C
Storage	-40 to +70 °C

Design code	Max. fiber count	Loose tube diameter [mm]	Cable size [mm]	Cable weight [kg/km]	Max. load (installation) [N]	Crush resistance [N/10 cm]
NEW Z001	60	2.3	10.7	94	2,500	2,000

HYBRID

Specification: Z047



Outdoor



Aerial

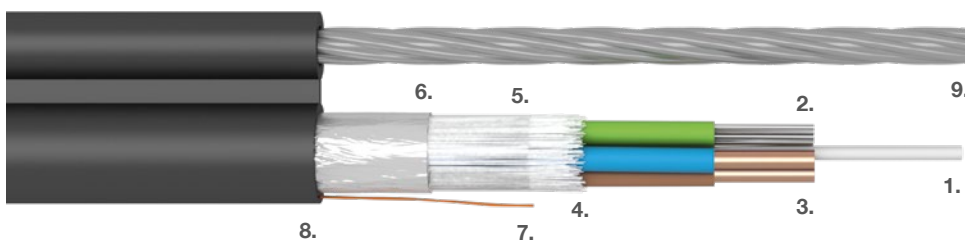

Description of materials:

1. FRP dielectric central strength member.
2. Gel filled PBT loose tube with optical fibers.
3. Cu wire
4. Waterblocking E-glass yarn.
5. Water-swellable tape.
6. Moisture barrier.
7. Rip-Cord.
8. PE outer jacket, UV stable.
9. Steel wire messenger.

Temperature range

Installation	-15 to +50 °C
Operation	-40 to +70 °C
Storage	-40 to +70 °C

Design code	Max. fiber count	Loose tube diameter [mm]	Cable size [mm]	Cable weight [kg/km]	Max. load (installation) [N]	Crush resistance [N/10 cm]
NEW Z047	12-36	2.5	21.1 × 11.2	218 (12 F + 3 Cu) 206 (24 F + 2 Cu) 194 (36 F + 1 Cu)	5,000	2,000

HYBRID

Specification: Z078, Z130



Indoor



Outdoor



Halogen free



FTTx



Duct

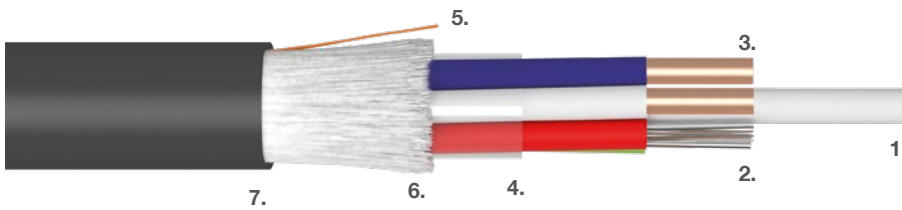

Description of materials:

1. FRP dielectric central strength member.
2. Gel filled PBT loose tube with optical fibers.
3. Cu wire 1.4/2.6 mm.
4. Water-swellable tape.
5. Rip-Cord.
6. Waterblocking E-glass yarn.
7. FR - LSZH or PE outer jacket, UV stable.

Temperature range

Installation	-15 to +50 °C
Operation	-40 to +70 °C
Storage	-40 to +70 °C

Design code	Max. fiber count	Loose tube diameter [mm]	Cable size [mm]	Cable weight [kg/km]	Max. load (installation) [N]	Crush resistance [N/10 cm]
NEW Z078	12–36	2.5	10.5	126 (12 F + 3 Cu) 110 (24 F + 2 Cu) 94 (36 F + 1 Cu)	2,000	2,000
NEW Z130	12–36	2.5	10.5	150 (12 F + 3 Cu) 134 (24 F + 2 Cu) 117 (36 F + 1 Cu)	2,000	2,000

HYBRID

Specification: Z131, Z132

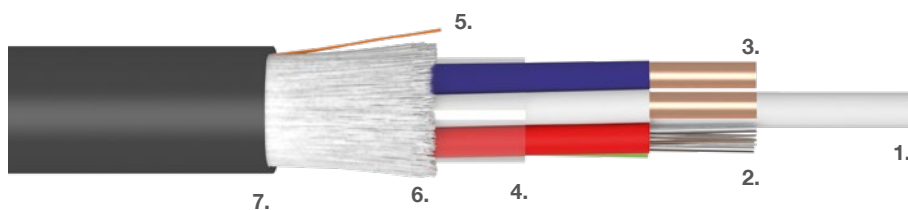

Description of materials:

1. FRP dielectric central strength member.
2. Gel filled PBT loose tube with optical fibers.
3. Cu wire 1.8/2.7 mm.
4. Water-swellable tape.
5. Rip-Cord.
6. Waterblocking E-glass yarn.
7. FR-LSZH or PE outer jacket, UV stable.

Temperature range

Installation	-15 to +50 °C
Operation	-40 to +70 °C
Storage	-40 to +70 °C

Design code	Max. fiber count	Loose tube diameter [mm]	Cable size [mm]	Cable weight [kg/km]	Max. load (installation) [N]	Crush resistance [N/10 cm]
NEW Z131	24–36	2.5	10.6	146 (12 F + 3 Cu) 125 (24 F + 2 Cu) 105 (36 F + 1 Cu)	1,900	2,000
NEW Z132	24–36	2.5	10.6	170 (12 F + 3 Cu) 150 (24 F + 2 Cu) 129 (36 F + 1 Cu)	1,900	2,000

HYBRID

Specification: Z212



Outdoor



FTTx



Duct

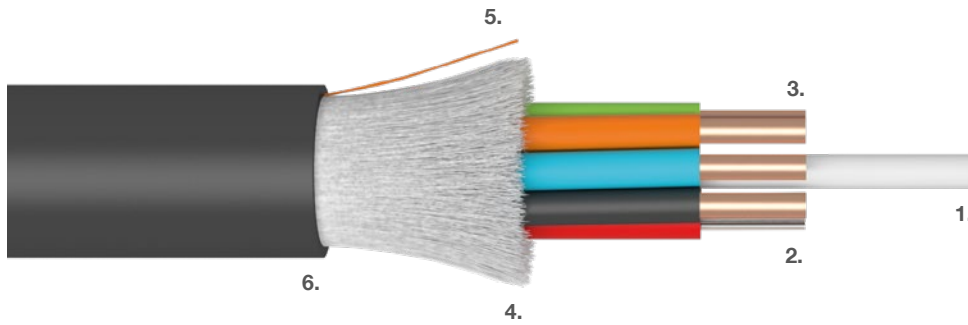

Description of materials:

1. FRP dielectric central strength member.
2. Gel filled PBT loose tube with optical fibers.
3. Cu wire 1.4/3.0 mm.
4. Waterblocking E-glass yarn.
5. Rip-Cord.
6. PE outer jacket, UV stable.

Temperature range

Installation	-15 to +50 °C
Operation	-40 to +70 °C
Storage	-40 to +70 °C

Design code	Max. fiber count	Loose tube diameter [mm]	Cable size [mm]	Cable weight [kg/km]	Max. load (installation) [N]	Crush resistance [N/10 cm]
NEW Z212	24	3.0	13.1	176	2,700	2,000

HYBRID

Specification: Z320



Outdoor



FTTx



Duct



Armoured



Antirodent

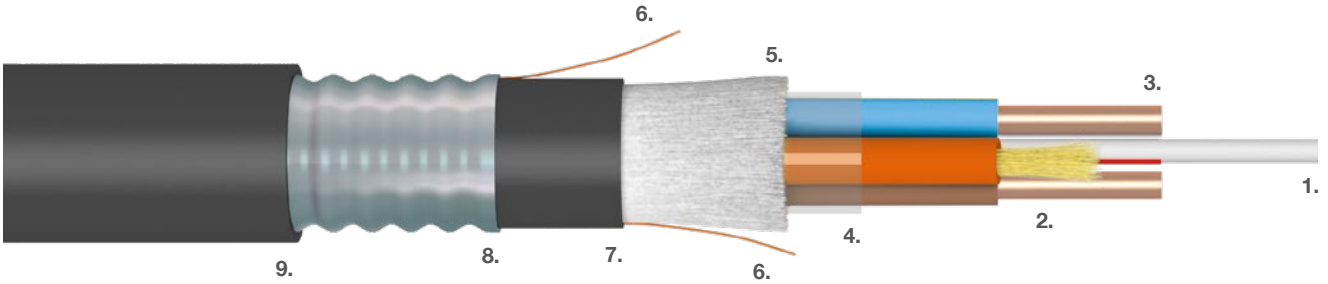

Description of materials:

- 1. FRP dielectric central strength member.
- 2. Simplex.
- 3. Cu wire 1.8/2.8 mm
- 4. Water-swellable tape.
- 5. Waterblocking E-glass yarn.
- 6. Rip-Cord.
- 7. PE inner jacket, UV stable.
- 8. Corrugated steel tape.
- 9. PE outer jacket, UV stable.

Temperature range

Installation	-15 to +50 °C
Operation	-40 to +70 °C
Storage	-40 to +70 °C

Design code	Max. fiber count	Simplex diameter [mm]	Cable size [mm]	Cable weight [kg/km]	Max. load (installation) [N]	Crush resistance [N/10 cm]
NEW Z320	2	2.8	15.5	249	2,000	5,000

HYBRID

Specification: TM5I, QM5I, WM5I



Outdoor



FTTx



Duct

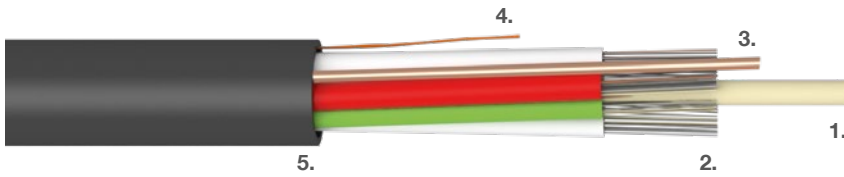

Description of materials:

1. FRP dielectric central strenght member. 2. Gel filled PBT loose tube with optical fibers.
3. Cu wire (AWG 24). 4. Rip-Cord. 5. PE outer jacket, UV stable.

Temperature range

Installation	-15 to +50 °C
Operation	-30 to +70 °C
Storage	-40 to +70 °C

Design code	Max. fiber count	Loose tube diameter [mm]	Cable size [mm]	Cable weight [kg/km]	Max. load (installation) [N]	Crush resistance [N/10 cm]
NEW TM5I	72	1.5	5.8	31	700	1,500
NEW QM5I	96	1.5	6.5	42	1,400	1,500
NEW WM5I	144	1.5	8.6	63	1,500	1,500

UNDERWATER

Specification: BWPI



Underwater



Outdoor



FTTx



Armoured



Antirodent

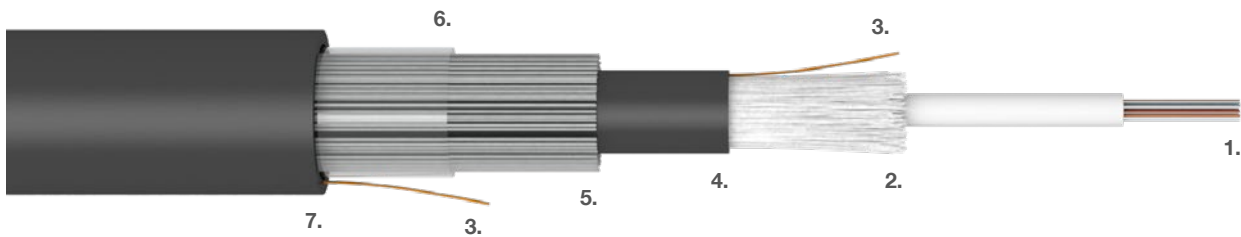

Description of materials:

1. Gel filled PBT loose tube with optical fibers. 2. Waterblocking E-glass yarn. 3. Rip-Cord.
4. PE inner jacket. 5. Steel Wire Armour (SWA). 6. Water-swellable tape.
7. PE outer jacket, UV stable.

Temperature range

Installation	-15 to +50 °C
Operation	-30 to +70 °C
Storage	-30 to +70 °C

Design code	Max. fiber count	Loose tube diameter [mm]	Cable size [mm]	Max. water depth [m]	Cable weight [kg/km]	Max. load (installation) [N]	Crush resistance [N/10 cm]
BWPI	24	3.0	11.0	120	199	4,000	4,000

UNDERWATER

Specification: LXPk, FXPK, GXPK, HXPk, IXPk



Underwater



Outdoor



FTTx



Armoured



Antirodent

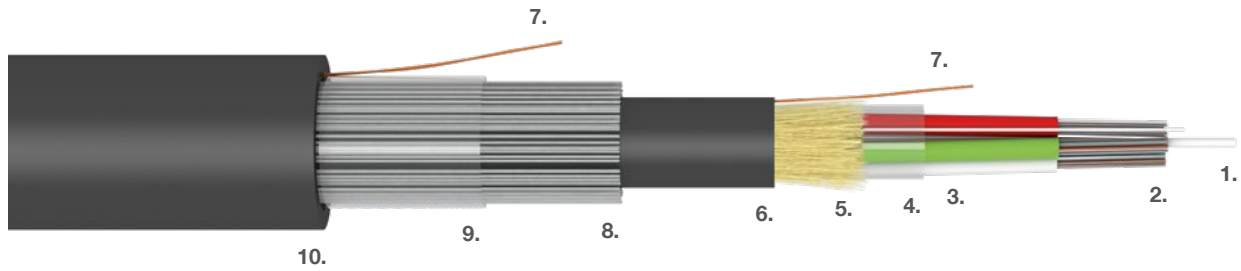

Description of materials:

1. FRP dielectric central strength member.
2. Gel filled PBT loose tube with optical fibers.
3. Gel filling.
4. PET foil.
5. Waterblocking aramid yarn.
6. PE inner jacket, UV stable.
7. Rip-Cord.
8. Steel Wire Armour (SWA).
9. Water-swellable tape.
10. PE outer jacket, UV stable.

Temperature range

Installation	-15 to +50 °C
Operation	-40 to +70 °C
Storage	-40 to +70 °C

Design code	Max. fiber count	Loose tube diameter [mm]	Cable size [mm]	Max. water depth [m]	Cable weight [kg/km]	Max. load (installation) [N]	Crush resistance [N/10 cm]
NEW LXPk	48	2.3	13.8	110	299	5,000	5,000
NEW FXPK	72	2.3	15.0	100	348	7,500	5,000
NEW GXPK	96	2.3	16.3	100	410	8,500	5,000
NEW HXPk	144	2.3	19.2	80	540	12,000	5,000
NEW IXPk	216	2.3	19.6	65	566	9,000	4,000

UNDERWATER

Specification: Z439



Underwater



Outdoor



FTTx



Armoured



Antirodent

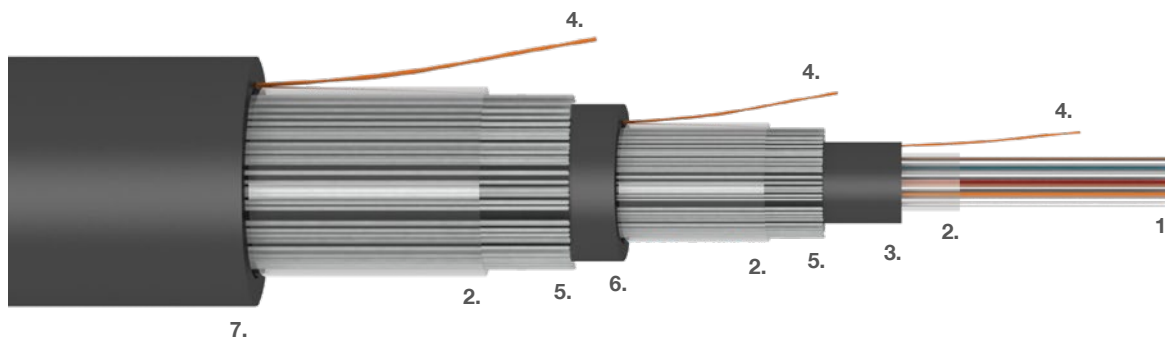

Description of materials:

- 1. Gel filled loose tube with optical fibers.
- 2. Water-swellable tape.
- 3. PE inner jacket, UV stable.
- 4. Rip-Cord.
- 5. Steel Wire Armour (SWA).
- 6. PE intermediate jacket, UV stable.
- 7. PE outer jacket, UV stable.

Temperature range

Installation	-15 to +50 °C
Operation	-30 to +70 °C
Storage	-30 to +70 °C

Design code	Max. fiber count	Loose tube diameter [mm]	Cable size [mm]	Max. water depth [m]	Cable weight [kg/km]	Max. load (installation) [N]	Crush resistance [N/10 cm]
NEW Z439	24	3.0	16.2	160	502	6,500	5,500

UNDERWATER

Specification: Z388



Underwater



Outdoor



FTTx



Armoured



Antirodent

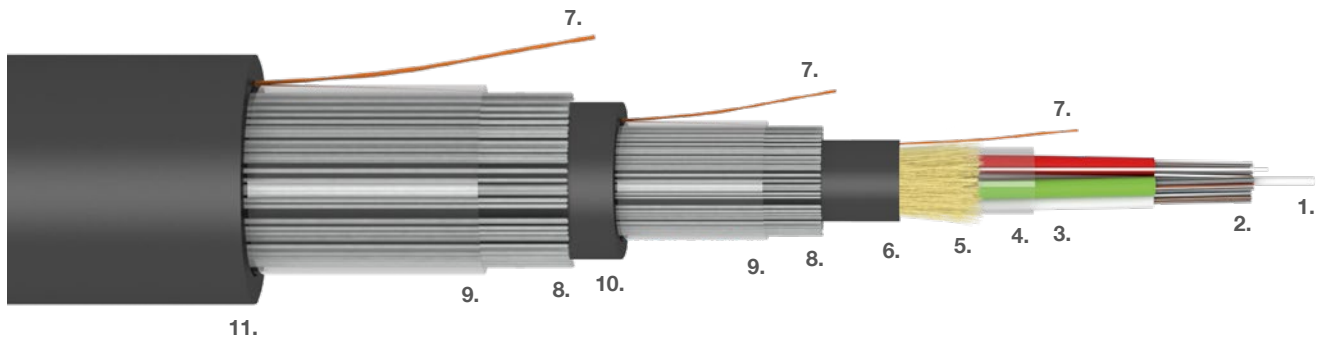

Description of materials:

1. FRP dielectric central strength member.
2. Gel filled PBT loose tube with optical fibers.
3. Gel filling.
4. PET foil.
5. Waterblocking aramid yarn.
6. PE inner jacket, UV stable.
7. Rip-Cord.
8. Steel Wire Armour (SWA).
9. Water-swellable tape.
10. PE intermediate jacket, UV stable.
11. PE outer jacket, UV stable.

Temperature range

Installation	-15 to +50 °C
Operation	-40 to +70 °C
Storage	-40 to +70 °C

Design code	Max. fiber count	Loose tube diameter [mm]	Cable size [mm]	Max. water depth [m]	Cable weight [kg/km]	Max. load (installation) [N]	Crush resistance [N/10 cm]
NEW Z388	48	2.3	19.0	150	654	14,000	8,000

ARMOURED MICRODUCT

Specification: Z387, Z410



Outdoor



FTTx



Armoured



Antirodent



Direct burial

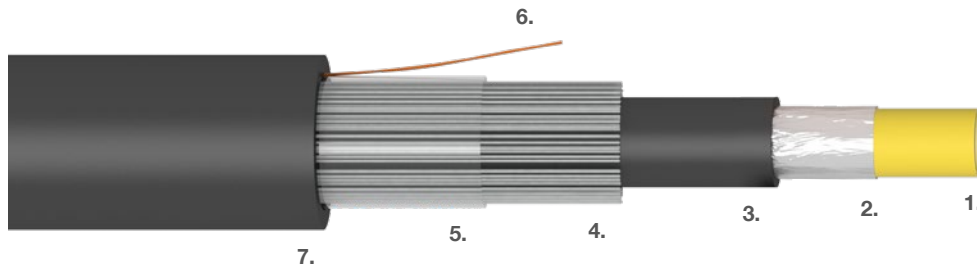

Description of materials:

1. Microduct. 2. Moisture barrier. 3. PE inner jacket, UV stable. 4. Steel Wire Armour (SWA). 5. Water-swellable tape. 6. Rip-Cord. 7. PE outer jacket, UV stable.

Temperature range

Installation	-15 to +50 °C
Operation	-40 to +70 °C
Storage	-40 to +70 °C

Design code	Outer jacket thickness [mm]	Microduct diameter [mm]	Cable size [mm]	Cable weight [kg/km]
NEW Z387	1.5	12/10	21.3±0.4	564
NEW Z410	1.5	14/12	23.8±0.4	725

FLES TUBE

Specification: FLES 3.0/8.5, FLES 4.32/20



Outdoor



Aerial

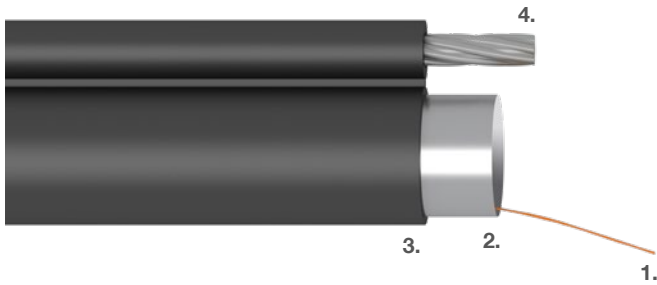

Description of materials:

1. Pulling element. 2. Moisture barrier. 3. PE outer jacket, UV stable. 4. Steel Wire messenger.

Temperature range

Installation	-15 to +50 °C
Operation	-30 to +70 °C
Storage	-40 to +70 °C

Design code	Inner diameter [mm]	Max. width of cable [mm]	Max. height of cable [mm]	Supporting element diameter [mm]	Max. load (installation) [N]
NEW FLES 3.0/8.5	8.5 ± 0.5	14,0	23.5	3.15	8,600
NEW FLES 4.32/20	20.0 ± 1.0	26.0	38.5	4.32	16,000

TRACER WIRE

Specification: Tracer wire 0.8/1.5, Tracer wire 1.13/2.8



Outdoor



Direct
burial



Description of materials:

1. Copper wire. 2. PE outer jacket, UV stable.

Temperature range

Installation	-15 to +50 °C
Operation	-40 to +70 °C
Storage	-40 to +70 °C

Design code	Wire diameter [mm]	Outer diameter [mm]	Cable weight [kg/km]	Cu content [kg/km]
NEW Tracer wire 0.8/1.5	0.8	1.5	6	5
NEW Tracer wire 1.13/2.8	1.13	2.8	14	10

KABELOVNA DECIN-PODMOKLY s.r.o. 03011

6. GENERAL SPECIFICATION

- COLOUR CODE CHARTS
- CODE TABLE
- STRIPABILITY OF THE TIGHT BUFFERED FIBER
- USED ABBREVIATIONS
- PROPERTIES OF THE CABLE SHEATH
- CHEMICAL RESISTANCE TABLE
- FIRE PROPERTIES

Colour Code Charts

IEC 60304 (Standard)

Tight Buffer

1	2	3	4	5	6	7	8	9	10	11	12
											
red	green	blue	yellow	white	grey	brown	violet	aqua	black	orange	pink
13	14	15	16	17	18	19	20	21	22	23	24
											
red + black strip	green + black strip	blue + black strip	yellow + black strip	white + black strip	grey + black strip	brown + black strip	violet + black strip	aqua + black strip	black + white strip	orange + black strip	pink + black strip

Loose Tube

1	2	3	4	5	6	7	8	9	10	11	12
											
red	green	blue	yellow	white	grey	brown	violet	aqua	black	orange	pink
13	14	15	16	17	18	19	20	21	22	23	24
											
red + black strip	green + black strip	blue + black strip	yellow + black strip	white + black strip	grey + black strip	brown + black strip	violet + black strip	aqua + black strip	natur + black strip	orange + black strip	pink + black strip

Multi Loose Tube – Tubes Colour Code



1	2	3	
			
red	green	natur	white

Note: Different colour sequences available on request.

Colour Code Charts

TIA/EIA 598

Tight Buffer

1	2	3	4	5	6	7	8	9	10	11	12
											
blue	orange	green	brown	grey	white	red	black	yellow	violet	pink	aqua
13	14	15	16	17	18	19	20	21	22	23	24
											
blue + black strip	orange + black strip	green + black strip	brown + black strip	grey + black strip	white + black strip	red + black strip	black + white strip	yellow + black strip	violet + black strip	pink + black strip	aqua + black strip

Loose Tube

1	2	3	4	5	6	7	8	9	10	11	12
											
blue	orange	green	brown	grey	white	red	black	yellow	violet	pink	aqua
13	14	15	16	17	18	19	20	21	22	23	24
											
blue + black strip	orange + black strip	green + black strip	brown + black strip	grey + black strip	white + black strip	red + black strip	natur + black strip	yellow + black strip	violet + black strip	pink + black strip	aqua + black strip

Loose Tube Cables – Sheath Colour

All Cables



black

Tight Buffer Cables – Sheath Colour

SM E9/125

G62,5/125 OM1

G50/125 OM2

G50/125 OM3

G50/125 OM4



yellow



blue



orange



aqua



violet

Note: Different sheath colour available on request.

Code table

TIGHT BUFFER CABLES

Position	1 Character	2 Character	3 Character	4 Character
	0 Fiber in tight SP	0 Buffer only	A Acrylate buffer	0 LDPE jacket
	1 Simplex cable	1 Ø simplex 1.8 mm	B	1 LSZH jacket
	2 Duplex cable	2 Ø simplex 2.0 mm	C –	2 LSZH jacket + FRP members in jacket
	3 Heavy-duplex cable	3 Ø simplex 3.0 mm	D –	3 LDPE jacket + FRP members in jacket
	4 Break-out cable	4 Ø simplex 2.4 mm	E –	4 LSZH / SWA / LSZH
	5 Distribution cable	5 Ø simplex 2.5 mm	F LSZH Free-tight buffer	5 LSZH / SWA / HDPE
	6 Multi-distribution cable	6 Ø simplex 1.6 mm	G –	6 PVC jacket – inner / universal cable
	7 Drop cable	7 Ø simplex 1.7 mm	H –	7 PUR jacket – inner / outdoor
	8 Break-out cable without central strenght member	8 Ø simplex 2.8 mm	– –	8 LSZH / glass yarn / LSZH
	9 Quadplex cable	9 Ø simplex 2.9 mm	– –	9 PUR jacket outdoor only
		A Distribution cable – Aramid	S LSZH Free-strip (semi-tight) buffer	A HDPE jacket
		D Distribution cable – Standard	T LSZH Tight buffer	B Buffer
		E Distribution cable – E-glass	– –	S E-glass yarn under jacket
		S Distribution cable – CST		K Aramid yarn under jacket
		V Distribution cable – waterblocking Aramid	X LSZH Shielded buffer	– –
		U Subunits with fibers	Y –	Y HDPE jacket + FRP elements in jacket
		Y –	Z –	Z –
		Z –	0 Fiber without buffer	
	Z (+number) custom designs			

LOOSE TUBE CABLES

Position	1 Character	2 Character	3 Character	4 Character
	A CLT max. 12 fibers	0 –	0 –	0 LDPE outer jacket, dry core
	B CLT max. 24 fibers	1 FIG.8 + CST one jacket	1 –	1 LDPE outer jacket, filled core
	C MLT 6 × 1.7 mm [6×12] – 72	2 FIG.8 + CST two jackets	2 Messenger 2.0 mm	2 LSZH outer jacket, dry core
	D MLT 6 × 2.3 mm [6×24] – 144	3 4 × 12 in relation to „N“ in the column 1	3 Messenger 3.0 mm	3 LSZH outer jacket, filled core
	E MLT 18 × 1.5 mm [18×12] – 216	4 6 × 12 in relation to „N“ in the column 1	4 Messenger 4.5 mm	4 PA outer jacket, dry core
	F MLT 6 × 2.3 mm [6×12] – 72	5 8 × 12 in relation to „N“ in the column 1	5 Grounding conductor in core	5 PA outer jacket, filled core
	G MLT 8 × 2.3 mm [8×12] – 96	6 12 × 12 in relation to „N“ in the column 1	6 Messenger 1.6 mm	6 PE / PA outer jacket, dry core
	H MLT 12 × 2.3 mm [12×12] – 144	7 18 × 12 in relation to „N“ in the column 1	7 FRP messenger	7 PE / PA outer jacket, filled core
	I MLT 18 × 2.3 mm [18×12] – 216	8 FIG. 8	8 FRP members in core	8 LSZH / PA outer jacket, dry core
	J MLT 5 × 2.3 mm [5×12] – 60	9 24 × 12 in relation to „N“ in the column 1	9 FeZn wires in jacket	9 LSZH / PA outer jacket, filled core
	K MLT 8 × 2.3 mm [8×24] – 192	A Aramid (WB)	A –	A AL + PE outer jacket, dry core
	L MLT 4 × 2.3 mm [4×12] – 48	B –	B Inner PA jacket	B AL + PE outer jacket, filled core
	M MLT 36 × 2.3 mm [36×12] – 432	C CST one jacket with aramid under jacket	C Inner PVC jacket	C –
	N ADSS	D CST two jacket with aramid under jacket	D Supporting element FeZn wire	D –
	P MLT 8 × 1.7 mm [8×12] – 96	E E-glass	E –	E –
	Q MLT 8 × 1.5 mm [8×12] – 96	F FRPA	F Inner FRNC jacket	F –
	R MLT 12 × 1.7 mm [12×12] – 144	G –	G –	G PUR outer jacket, dry core
	S MLT 12 × 2.3 mm [12×24] – 288	H CST one jacket with E-glass yarns under jacket	H –	H PUR outer jacket, filled core
	T MLT 6 × 1.5 mm [6×12] – 72	I CST two jackets with E-glass yarns under jacket	I –	I HDPE outer jacket, dry core
	U MLT 5 × 1.7 mm [5×12] – 60	J –	J –	J –
	V MLT 18 × 1.7 mm [18×12] – 216	K –	K –	K HDPE outer jacket, filled core
	W MLT 12 × 1.5 mm [12×12] – 144	L Attenuated (lower tensile strenght and jacket)	L Inner Al/PE	L –
	X New custom designs	M Micro cable (without strenght members)	M –	M –
	Y MLT 12 × 2.8 mm [12×24] – 288	N –	N –	N –
	Z (+number) custom designs	P (jacket – aramid – jacket)	P Inner PE jacket	P PVC outer jacket, dry core
		Q (jacket – E-glass – jacket)	Q –	Q PVC outer jacket, filled core
		R Improved resistance	R 15 kN – 2 jackets	R –
		S Self-supporting nonmetallic strength member	S –	S –
		T Self-supporting dielectric member – two jackets	T –	T Track resistant HDPE
		U –	U	U –
		V –	V	V –
		W SWA two jackets – without strenght members	W	W –
		X SWA two jackets – aramid on core	X 3 kN – 1 jacket	X –
		Y SWA two jackets – E-glass on core	Y 6 kN – 2 jackets	Y –
		Z –	Z 9 kN – 2 jackets	Z –

Stripability of the Tight Buffered Fiber

TIGHT (CODE T)	stripability up to 10 cm
FREE (CODE F)	stripability more than 100 cm

Used Abbreviations

LSZH	LOW S MOKE, Z ERO H ALOGEN
LS0H	LOW S MOKE, Z ERO H ALOGEN
LSHF	LOW S MOKE, H ALOGEN F REE
HFFR	H ALOGEN F REE, F LAME R ETARDANT
FRNC	F IRE R ETARDANT, N ON- C ORROSIVE
FR-LSZH	F IRE R ETARDANT – LOW S MOKE, Z ERO H ALOGEN

Properties of the Cable Sheath

	LDPE	HDPE	PA	FR-LSZH	PUR
Flexibility	Medium	Low	Low	High	Very High
Water Resistance	High	High	Medium	Medium	Medium
Abrasion Resistance	High	High	High	Low	High
UV Radiation Resistance	High	High	Low	High	High
Brittleness in Low Temperature	Medium	Medium	Low	Medium	Very Low

Chemical Resistance Table (@ 20 °C)

	LDPE	HDPE	PA	FR-LSZH	PUR
Acids, Dilute or Weak	E	E	F	N	G
Acids', Strong or Concentrated	E	E	N	N	F
Alcohols, Aliphatic	E	E	N	N	F
Aldehydes	G	G	F	F	G
Bases	E	E	F	G	N
Esters	G	G	E	N	N
Hydrocarbons, Aliphatic	F	G	E	F	E
Hydrocarbons, Aromatic	F	G	E	N	N
Hydrocarbons, Halogenated	N	F	G	N	N
Ketones	G	G	E	N	N
Oxidizing Agents, Strong	F	F	N	N	N
Salts	E	E	E	G	E
Crude Oil	N	N	G	F	F
Kerosene	F	F	E	N	F
Mineral Oil	G	G	E	N	F

* For oxidizing acids, see „Oxidizing Agents, strong“.

E

30 days of constant exposure causes no damage. Plastic may tolerate for years.

G

Little or no damage after 30 days of constant exposure to the reagent.

F

Some effect after 7 days of constant exposure to the reagent.
The effect may be crazing, cracking, loss of strength or discoloration, depending on the plastic.

N

Not recommended. Immediate damage may occur. Depending on the plastic, the effect may be severe crazing, cracking, loss of strength, discoloration deformation, dissolution or permeation loss.

Note: This table must be considered as an orientation.

Fire properties

		METHOD	COMMENT
Fire properties – Flammability	pass	EN 60332-3-22 (cat. A) EN 50266-2-2	- 40 min exposure to flame - length of the burned sample max. 2.5 m
Fire properties – Acid gases	pass	EN 60754-1 EN 60754-2	- min. pH 4.3 - max. 10 µS/mm
Fire properties – Smoke density	pass	EN 61034-1 EN 61034-2	- min. 60 %

Note: Valid for all FR-LSZH sheaths.

Fire Properties

FLAME-RETARDANT

The cable must meet the requirements of the test specified in IEC standard 60332-3 or IEC 60332-1. The cable does not propagate fire and is self-extinguishing.

Notice: You can not assume that if the cable passes the test according 60332-1, a bundle of such cables passing a test 60332-3.

TEST ACC.
TO IEC 60332-1

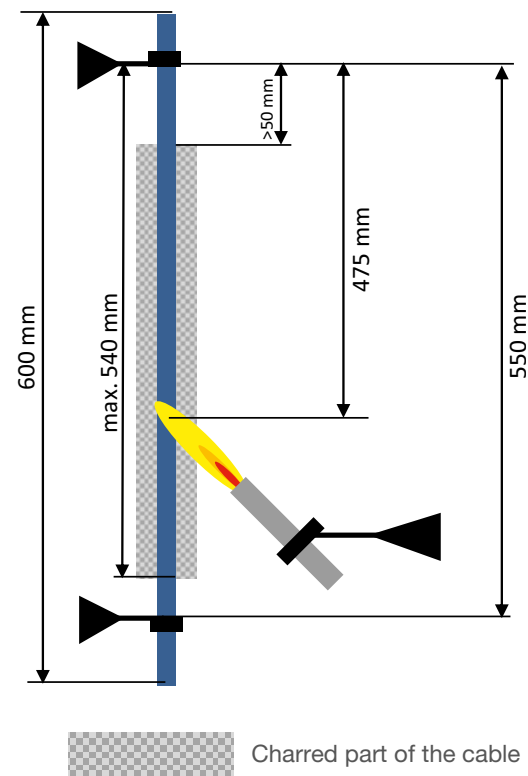

TEST ACC.
TO IEC 60332-3

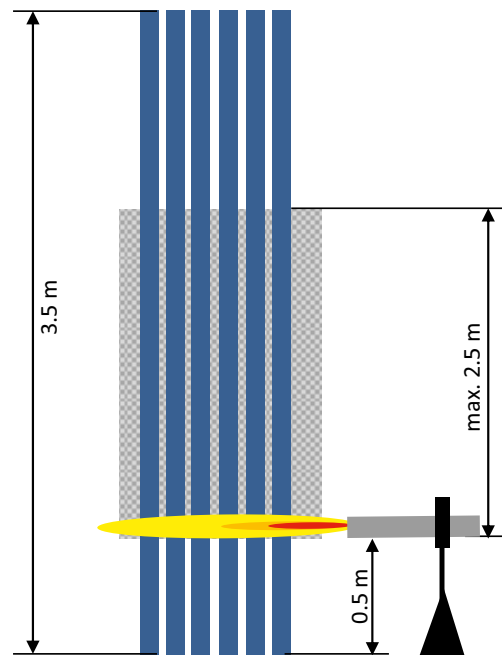

Cable Diameter	Burning Time
≤ 25 mm	60 sec
≥ 25 mm; ≤ 50 mm	120 sec

Category	Amount of Burning Material	Burning Time
A*	7.0 lt/m	40 min
B	3.5 lt/m	40 min
C	1.5 lt/m	20 min
D	0.5 lt/m	20 min

* KDP Cables

FIRE-RESISTANT

The cable must meet the requirements test specified in standard IEC 60331-11 and 25. The cable must be functional a minimum of 90 minutes in direct fire.

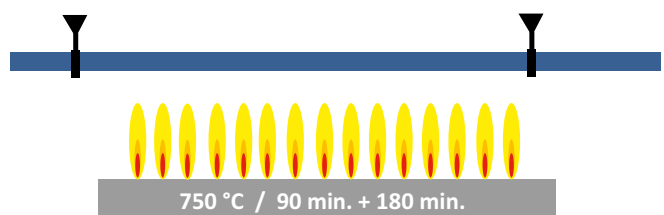





7. INSTALLATION AND MANIPULATION

- INTRODUCTION
- MANIPULATION AND STORAGE
- REWINDING/UNWINDING OF CABLE
- BEND RADIUS OF CABLE
- PULL STRENGTH OF CABLE
- VERTICAL INSTALLATION
- TWIST OF CABLE

Introduction

It is very easy to damage optical cables if manipulation with them is incorrect or if important installation procedures are not followed.

The information stated below should be taken into consideration when installing and manipulating with optical cables. Violating any of the basic rules can result in worsening of the cable's transfer characteristics or it can permanently damage it and shorten its lifetime. The handbook can also serve as a guideline for solving problem not only related to the installation of new cables but also for possible problems of cables, which have already been installed.

There is an assumption that the customer has general knowledge about the design of optical cables and the terminology related to it. If necessary, please contact KDP.

Symbols Used:



Manipulation and Storage

The drums with the cables cannot be thrown from any heights!
The drums with optical cables have to always stand on the edges of the head, secured with a wedge to prevent movement. The only time when it is not necessary to secure the drums with a wedge is when the drums are mutually secured between each other by standing them crosswise. /Pic. 1

It is possible to store HEAVYDUPLEX, SIMPLEX, DUPLEX type cables and coils with cables up to 4mm in diameter by laying them on the head. However, the cable has to be fastened by shrink wrap to prevent the loosening of individual cable coils.

Cables intended for internal use can only be stored in closed areas without humidity. Cables for universal and outdoor use can be stored in outdoor conditions. However, the cable ends have to be waterproof. However, if the cable is on a plywood spool, it has to be stored in such a manner so as to prevent the effects of water on the spool.

When manipulating with the drums using a crane, a spacer rod has to be placed between the load bearing ropes, so that the ropes do not exert pressure on the cable through the side drums. /Pic. 2

When lifting the drums using a forklift, the drums can only be gripped from the sides and only when the skids of the forklift are long enough for the head of the drum to be positioned on it with a safe overhang. /Pic. 3

It is only possible to roll the drums short distances and only on a hard and flat surface.

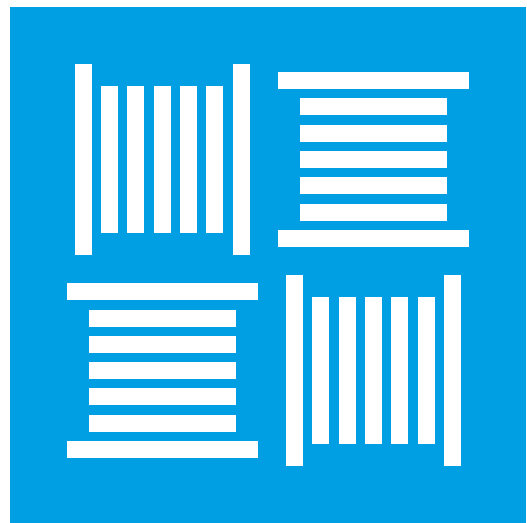

Pic. 1

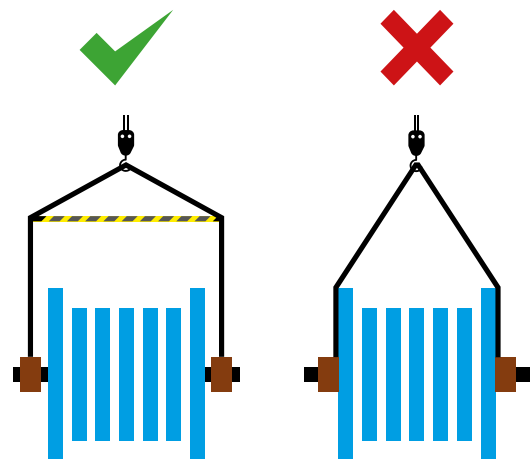

Pic. 2

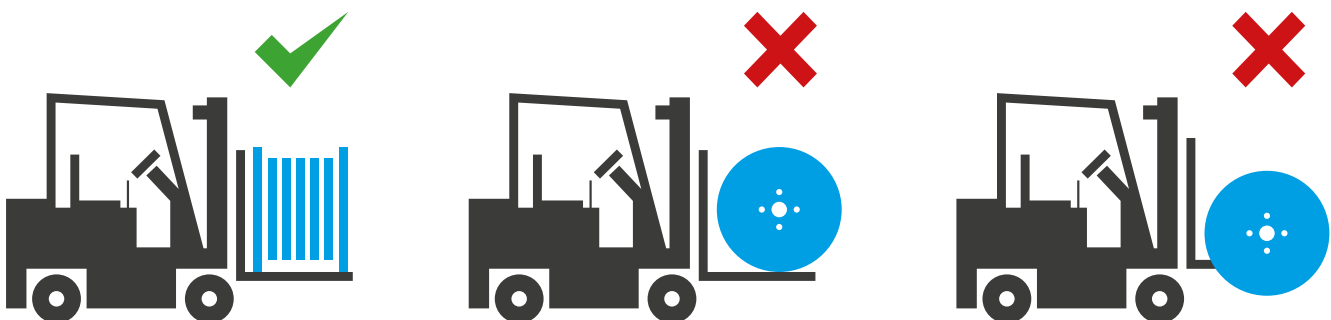

Pic. 3

Rewinding/Unwinding of Cable

The rewinding and unwinding of cables is only possible in temperature above 5 °C. If for any reason, it is necessary to unwind the cable in a lower temperature, the cable has to be left at a minimum temperature of 20 °C for at least 24 hours beforehand. For rewinding the cable, the winding (bending) direction of the cable has to be maintained, unwinding cannot form an “S” shape. /Pic. 4

When unwinding the cable, it is necessary to maintain continuous pull without variation. Unwinding without pull can then lead to the loosening of individual rolls and to the consequent mutual under pull, possibly to the uncontrolled, sharp tugging of the cable, resulting in the damaging of the optical fibers.

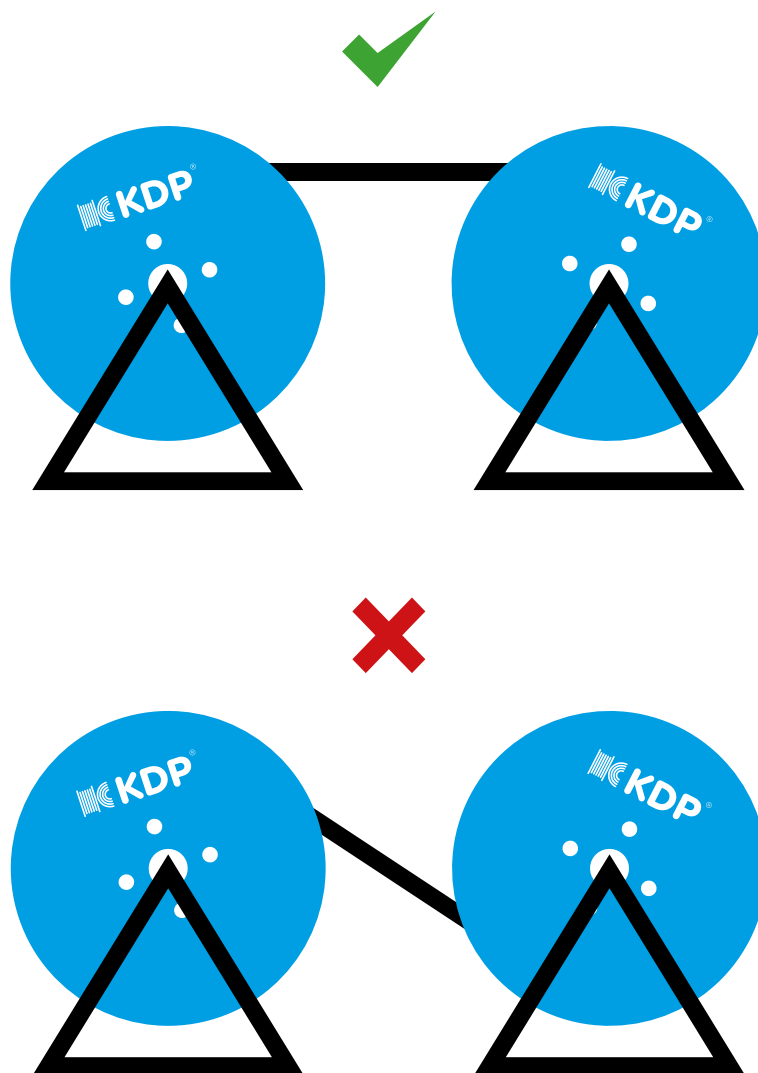

Pic. 4

Bend Radius of Cable

This value is defined by the cable manufacturer and exceeding this value can cause invisible fiber damage, which does not have to be evident immediately following installation, but later on. Therefore, it is important to follow the minimum bend diameter not only during in-stallation but also for a cable, which has already been installed.

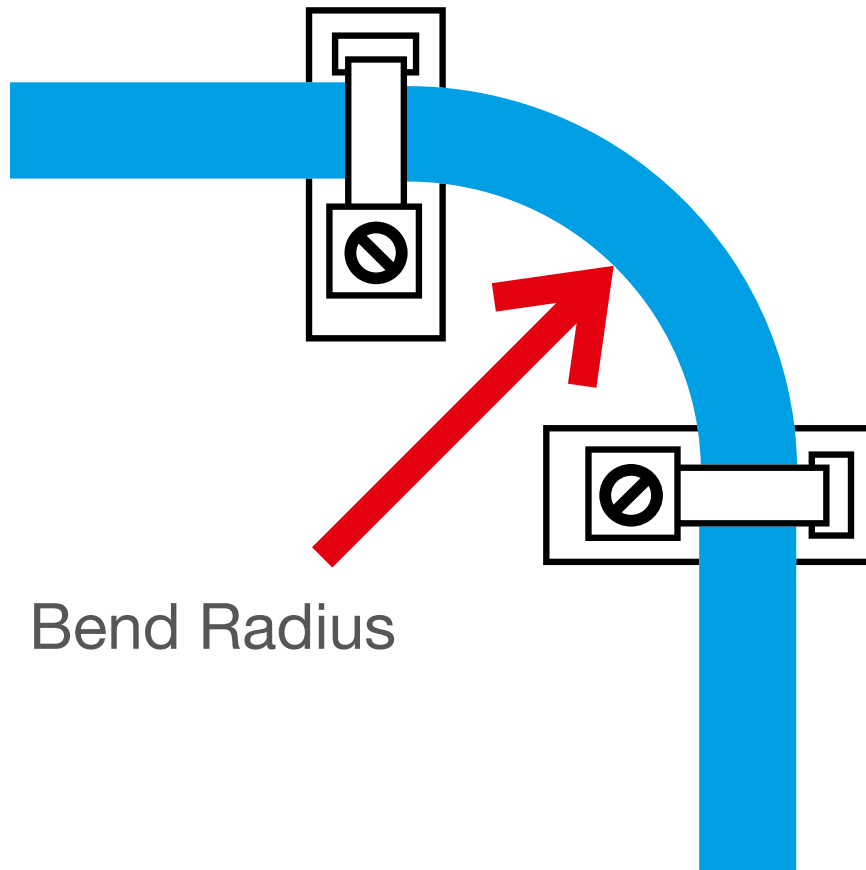

Pic. 5

Pull Strength of Cable

Unless stated otherwise, all optical cables manufactured at KDP are designed for conditions under which there is not pull strain exerted during operations, or only such a pull that the fiber in the cable is not strained (such an option is stated in the cable specification). If the straining of cables takes place in operations, we recommend consulting such situation with KDP prior to cable installation.

The maximum pull defined is for the purpose of cable installation and this value should never be exceeded! It is not force that snaps the cable in two, but the limit which guarantees that the fibers will not be damaged.

For checking purposes, upon installation, it is strongly recommended to place a mid-cable and a pull cable measuring pull for the continuous monitoring of the current cable pull. If necessary, also record a video of the course of installation, which then significantly aids in resolving consequent problems following installation. In order to decrease resistance when dragging, it is suitable to use a lubricant. Prior to use, verify that it is compatible with the material of the cable coating.

Vertical Installation

A gel, resistant to dripping up to 70 °C for a period of 24 hours, is used in optical KDP cables. This gel is also excludes oil and maintains its characteristics for the entire lifetime of the cable. Therefore, it is possible to install optical cables with independent secondary protection, a gel-filled tube, vertically, either as a construction with one central tube as well as multi-tube cables. This does not apply for multi-tubes, where the inner cable tube (the space between the individual tubes) is filled with gel. We do not recommend installing such cables vertically.

Conditions for the bend radius of the pull strength and other parameters are the same as for any common horizontal installation. The procedure applies for installation outdoors as well as indoors, sewage systems, etc.

The vertical placement of cables has to be fastened by clamps, to prevent sliding. The maximum distance between individual clamps has to be such, where the weight of the cables between the clamps exceeds the pull strength and does not strain the fibers in the cable. Horizontal loops will form on vertically running cable as a relief element and protection against the possible movement of the cable in case of vibration of the load bearing construction against fixed mounting in the lower part of the cable. The distance of the loops depends on the inner diameter of the tubes in the cable. /Pic. 6

If the cable in the lower part directly enters into the connector panel, it should enter by 3 loops. The purpose of this is to compare the change in the lengths of cables given the change in temperatures. This is from the lower part of the panel. /Pic. 7

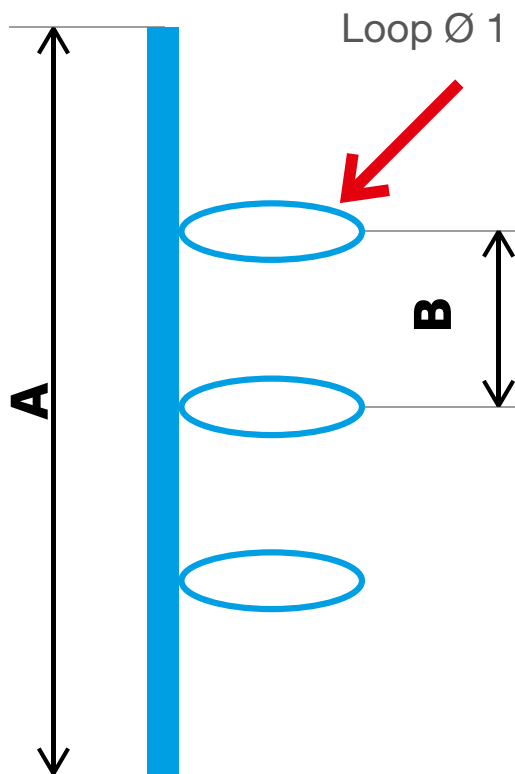

Tube Diameter		
A	500 m	300 m
B	20 m	20 m

Pic. 6

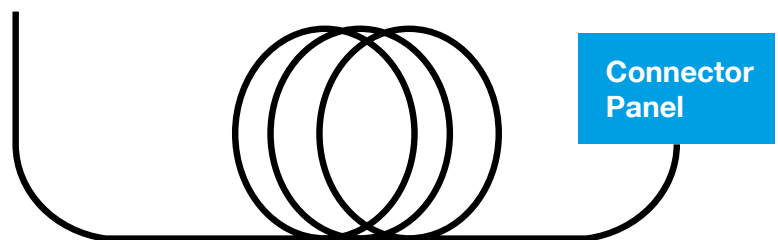

Pic. 7

Twist of Cable

Avoid twisting the cable during installation because this can cause stress to the fiber. If you install a cable longer than 30 m and you are pulling it through a narrower section (for example, underground), unwind the cable beforehand. Place cables freely in a figure eight on the floor. /Pic. 8. Placing cables in a loop prevents twisting. The diameter of the loop should be 2–4 m, depending on the rigidity of the cable. The length of the figure eight is 8–10 m.

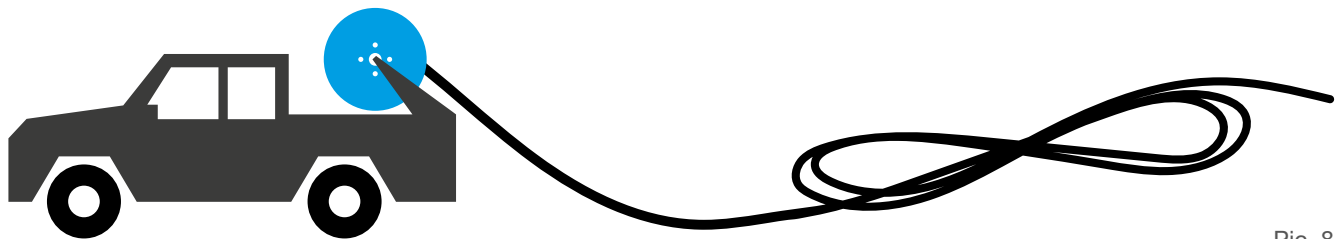

Pic. 8

It is recommended to place for example, cardboard paper between individual rolls.
Pic. 9

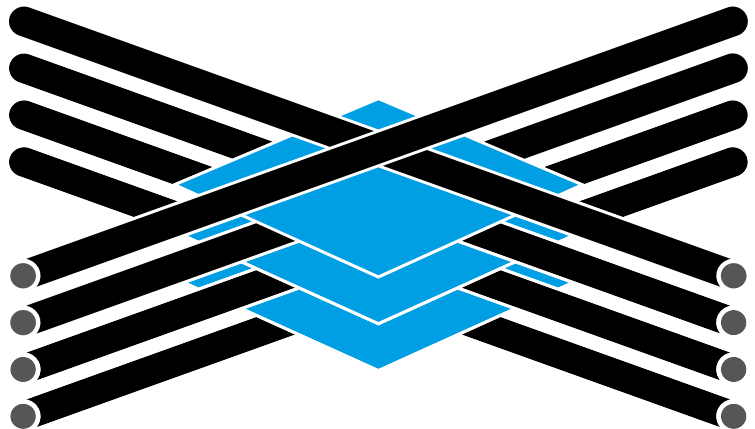

Pic. 9

Prior to taking the cable from the figure eight, tilt it by 180°, with the aid of other individuals, so that the beginning of the cable is facing upward. /Pic. 10

After pulling it through, do not wind it back up onto the drum, but place it back in a figure eight for further laying.

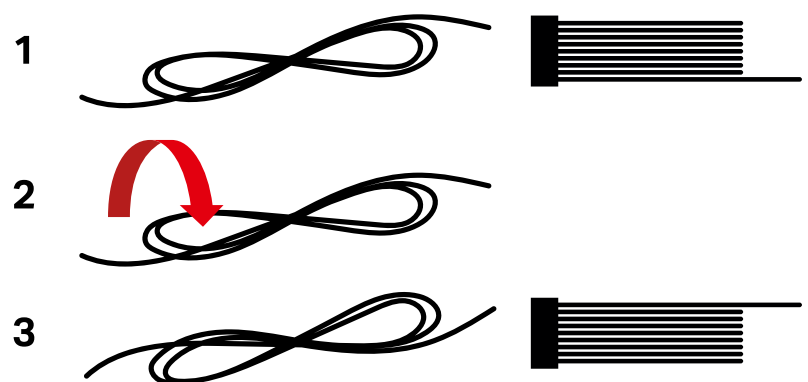

Pic. 10



 KDP |  KDP - World Connecting Cables

KABELOVNA Děčín Podmokly, s.r.o.

Ústecká 840/33 | 405 33 Děčín | Czech Republic

Phone: +420 412 706 111 | **E-mail:** sales@kabelovna.cz

www.kabelovna.cz