



Metallic cables
Product catalogue 2022

 **KDP**[®]
WORLD CONNECTING CABLES

Dear Customers,

since 1910 we have been supplying the cables which help you to solve your problems through communication. Enclosed, please, find a new comprehensive catalogue containing the basic product line of our company.

We tried not only to include the standard products that you probably know very well, but some innovations and brand new products as well. Despite the catalogue is considered as a complete presentation of our production, not all variants can be published and included.

For some special products, please, contact our Sales Department that will provide you with any information requested. Let us advise you of the fact that all cable parameters in this catalogue are for information only.

All rights reserved.



Lenka Mádlová
Head of Commercial Department – Member of board

Summary

1. TELECOMMUNICATION CABLES

A-02YSF(L)2Y	12
A-2YF(L)2Y	14
A-02Y(L)2Y	16
A-2Y(L)2Y	18
TK 59 GM	20
TK 53 UM (aerial)	22
HRQHQZKAHQ (Qv – jelly filled)	24
HRQHQZKAHQ – AkVQ (Qvr – armoured)	26
LRQHQAQHQ (QI – aerial)	28
CW 1128, CW 1128/1179	30
CW 1171/CW 1179	32
CW 1224/CW 1179	34
CW 1236, CW 1236/CW 1179	36
CW 1326, CW 1326/CW 1179	38
CW 1600	40
TCEPKPFLEZE, TCEPKPFLEZY	42
TCEKFLE, TCEKFLEY	44
TCEKFLEZE, TCEKFLEZY	46
TCEKFLES	48
TCEKFLH	50
TCEKFLHZH	52
TCEPKPFLE, TCEPKPFLEY	54

2. SIGNAL CABLES

A-HH	58
A-H(L)H	60
A-HHBH	62
AJ-HHAH	64
A-2Y2YV	66
A-2Y(L)2YV	68
A-2Y2YB2Y	70
A-2Y(L)2YB2Y	72
AJ-2Y2YDB2Y	74
AJ-2Y(L)2YDB2Y	78

3. INSTALLATION CABLES

J-Y(ST)Y	82
J-H(ST)H	84
U72 U72-H	86
FRQKAHM (QF – INDOOR)	88
UTP CAT 5, CAT 5E	90
UTP CAT 3 – 100 Ω	91
CW 1308	92

4. GENERAL SPECIFICATION

CABLE CODES	96
-------------	----

5. INSTALLATION AND MANIPULATION

MANIPULATION AND STORAGE	100
REWINDING/UNWINDING OF CABLE	101
BEND RADIUS OF CABLE	102

Index

type of cable	page	type of cable	page
A-02Y(L)2Y	16	HRQHQZKAHQ – AkVQ (Qvr – armoured)	26
A-02YSF(L)2Y	12	HRQHQZKAHQ (Qv – jelly filled)	24
A-2Y2YB2Y	70		
A-2Y2YV	66		
A-2YF(L)2Y	14	J-H(ST)H	84
A-2Y(L)2Y	18	J-Y(ST)Y	82
A-2Y(L)2YB2Y	72		
A-2Y(L)2YV	68		
A-HH	58	LRQHQAQHQ (QI – aerial)	28
A-HHBH	62		
A-H(L)H	60	TCEKFLE, TCEKFLEY	44
AJ-2Y2YDB2Y	74	TCEKFLES	48
AJ-2Y(L)2YDB2Y	78	TCEKFLEZE, TCEKFLEZY	46
AJ-HHAH	64	TCEKFLH	50
		TCEKFLHZH	52
		TCEPKPFLE, TCEPKPFLEY	54
		TCEPKPFLEZE, TCEPKPFLEZY	42
CW 1128, CW 1128/1179	30	TK 53 UM (aerial)	22
CW 1171/CW 1179	32	TK 59 GM	20
CW 1224/CW 1179	34		
CW 1236, CW 1236/CW 1179	36		
CW 1308	92		
CW 1326, CW 1326/CW 1179	38		
CW 1600	40		
		U72 U72-H	86
		UTP CAT 3 – 100 Ω	91
		UTP CAT 5, CAT 5E	90
FRQKAHM (QF – INDOOR)	88		

History and present of **KABELOVNA** Děčín Podmoky

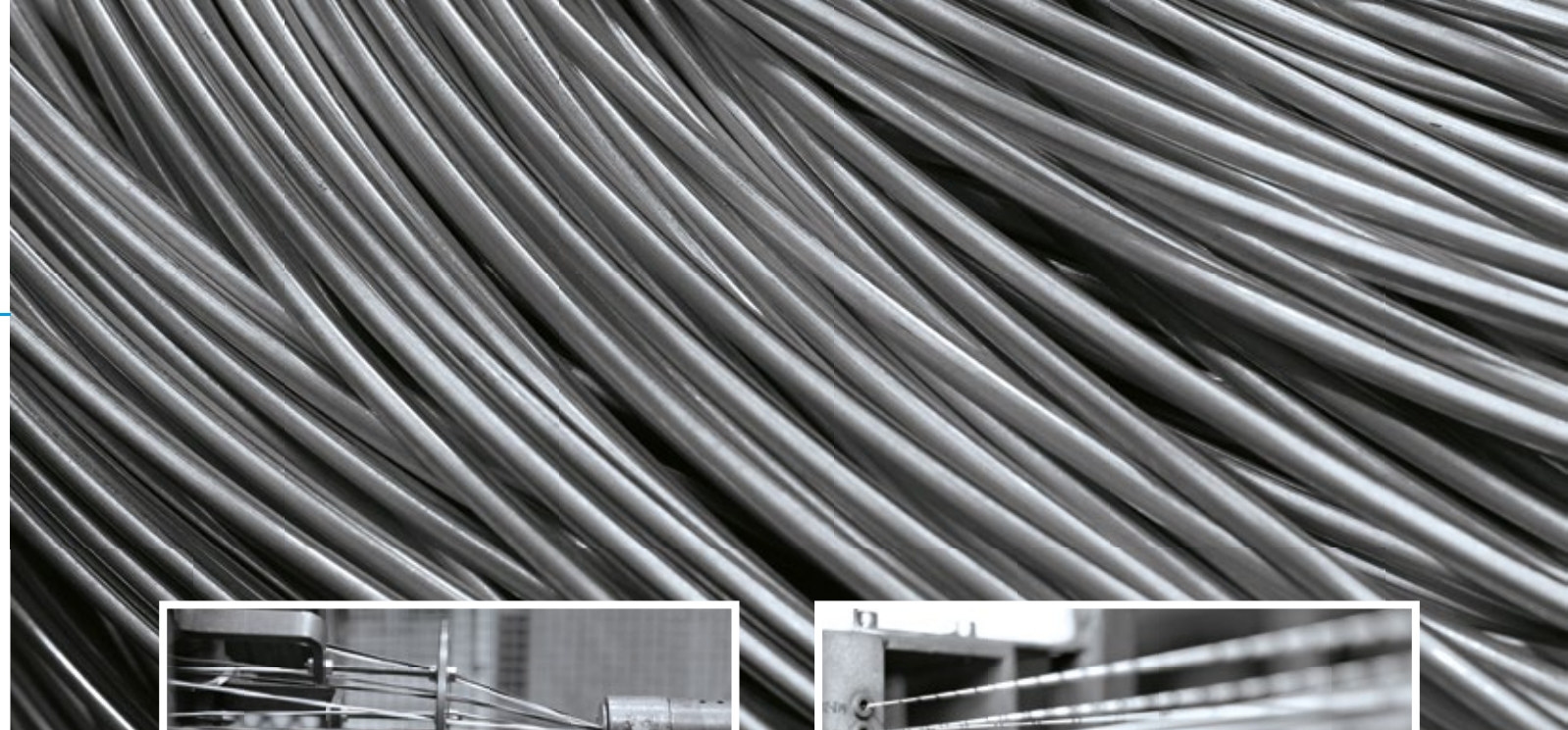

KDP was founded in 1909 and 1910 as a branch of the Bergmann cable plants in Berlin, the original name of the company being „Rakouské Bergmannovy závody spol. s r.o., Vídeň, továrna Podmoky“.

From the very outset the plant manufactured all types of power and communications cables with lead casing and the relevant cable sets, as well as rubber-insulated conductors, dynamo wires and insulation pipes with accessories. Company activity at that time also included projects involving electrical equipment and its installation.

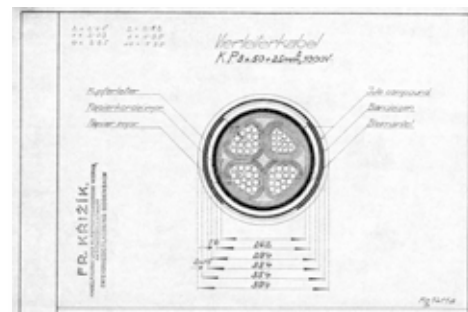

The cable factory came into the hands of Anglo-Pragobanka as part of Křížík a spol. Praha after the First World War and this company reconstructed the entire business. The production of trunk communications cables got underway at this time. The cable factory and neighbouring copper works were then merged in 1932 as the „Měďárna, kabelovna a elektrotechnické závody Křížík-Chaudoir, Praha“. However, the production programme at the cable factory did not change too radically.

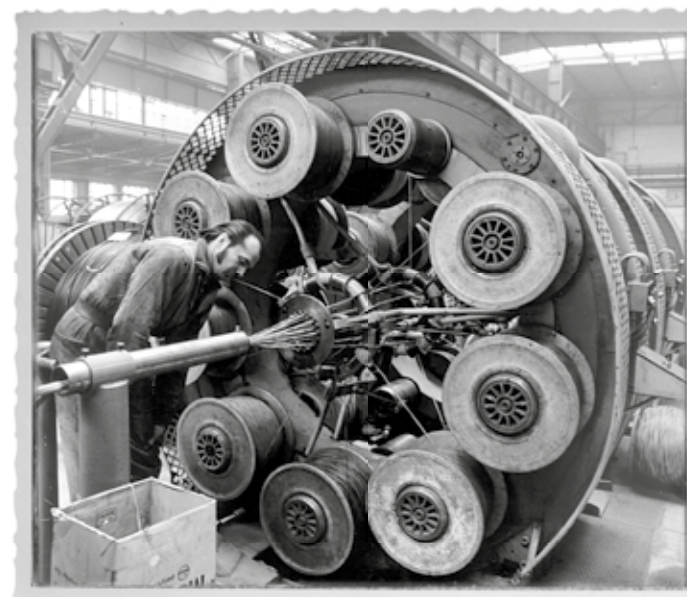

The company was nationalised after 1945. It was later incorporated as part of KABLO Kladno and its specialisation amplified. The main production programme became the manufacture of communications cables and in 1961 KABLO Děčín became the monopoly producer of cables for local and long-distance telecommunications networks using top-of-the-range technology. The company was privatised after 1990, became independent again and returned to its traditional name of KABELOVNA Děčín-Podmoky, a.s. SIEMENS AG then entered the company in 1992. The result of mutual cooperation here was considerable modernisation of production technology, the expansion of the range produced and the strengthening of KABELOVNA Děčín-Podmoky, a.s. on global markets.

SIEMENS sold its share in KABELOVNA to American venture-capital fund Bancroft Eastern Europe Fund L.P. in July 2000, before this company in turn sold its share to American company CDT (Cable Design Technology) in December 2001. CDT then merged with American company BELDEN in 2004, the newly-founded company taking on the name of Belden CDT Inc.

2007 the cable works is sold to Wilms Gruppe, the company is divided into Kabelovna Děčín Podmoky, s.r.o. and KDP Assembly, s.r.o.



History

4. 9. 1909	Execution of contract on establishment of company „Rakouské Bergmanovy závody, Berlín, elektrotechnická společnost, s. r. o.“ with branch in Vienna.
27. 6. 1911	Launch of Production – 750 employees. Production of power and communication cables, cable sets and accessories, rubber wires and insulation tubes including accessories.
05/1919	The company was acquired by „Elektrotechnické závody František Křížík, Praha, a. s.“ Initiation of remote communication cables production.
03/1930	The company completely burnt down. Production restored at the end of year 1930.
05/1945	The company came under national control of Křížík a. s. corporation. Then it was nationalized and became a part of national company KABLO Bratislava. Production of power and communication cables with lead coating, rubberized wires and coil wires.
1. 1. 1950	Establishment of national company KABLO Děčín.
1959	Production of remote communication cables.
1961	KABLO Děčín became a monopoly producer of communication cables for local networks.
1982–1984	Construction of new hall to expand the production of communication cables.
1985	Termination of power cables production.
1988	Initiation of optic cables production.
31. 12. 1990	Privatization, establishment of incorporated company. The original name KABELOVNA Děčín Podmokly, a. s. was used.
1992	Company share acquisition by SIEMENS AG.
1994	Initiation of cable assemblies production.
1995	ISO 9001 certification completed.
1996	Initiation of installation cables production.
1996	Czech Republic Quality Award.
1998	ISO 14001 certification completed.
2000	Establishment of subsidiary company KDP Kabeltechnik Berlin, GmbH.
2000	Sale of SIEMENS AG share to investment fund BANCROFT CZ.
2001	CDT Pittsburgh becomes a majority owner of the company.
2002	Complete renewal of optic cable assortment.
2003	Initiation of data cable production.
2004	Merge with Belden company, Belden CDT inc. was established.
2007	Wilms Gruppe becomes a new owner of KABELOVNA.
2010	KABELOVNA Děčín Podmokly, s.r.o. celebrates 100 th Anniversary.
2015	New portfolio of cable constructions.
1. 1. 2016	KABELOVNA Děčín Podmokly, s.r.o. has become a member of FTTH Council.

Certificates and CPR

PROHLÁŠENÍ O VLASTNOSTECH
Č. 1/17M

1. Jednotlivé identifikační kód nebo úprava	1. IDENTIFIKACE ... PE, PY, ZE, ZV, ZH, DE, DV, Y, S [Př. N. K. (KABLOVA), N. P. (K. (KABLOVA))]
2. Změněné použití nebo změněné použití	Sběrovací a přenosná síť
3. Výrobce	KABELOVNA Děčín Podmokly, s.r.o., Ústecká 840/33, 405 33 Děčín I, ČESKÁ REPUBLIKA
4. Zpracovatel nebo výrobce	
5. Systém nebo systémy POEVI	4
6. Normativní norma	EN 50275:2014+A1:2016
7. Deklarace vlastností výrobce	Realizace na místě Nepřesahující síť
8. Přiložené technické dokumentace včetně speciální technické dokumentace	Prohlášení a tabulka E

Vlastnost výrobce uvedené výše jsou ve shodě se skutečným dědictvím výrobce. Tato prohlášení o vlastnostech se v souladu s nařízením (EU) č. 305/2011 vztákné na výrobci odpovědně vyplněno výrobcem výrobce výše.

Místo vydání: Děčín Datum vydání: 28.6.2017
Podpisem za výrobce a jeho jménem: Ing. Lenka Málková
Funkce: Odborný řešitel





1. TELECOMMUNICATION CABLES

A-02YSF(L)2Y

A-2YF(L)2Y

A-02Y(L)2Y

A-2Y(L)2Y

TK 59 GM

TK 53 UM (aerial)

HRQHQZKAHQ (Qv – jelly filled)

HRQHQZKAHQ – AkVQ (Qvr – armoured)

LRQHQKAHQ (Ql – aerial)

CW 1128, CW 1128/1179

CW 1171/CW 1179

CW 1224/CW 1179

CW 1236, CW 1236/CW 1179

CW 1326, CW 1326/CW 1179

CW 1600

TCEPKPFLEZE, TCEPKPFLEZY

TCEKFLE, TCEKFLEY

TCEKFLEZE, TCEKFLEZY

TCEKFLES

TCEKFLH

TCEKFLHZH

TCEPKPFLE, TCEPKPFLEY

A-02YSF(L)2Y

...x2x0.4 (0.5; 0.6; 0.8) ST III BD (H42; H50; H52; H55)

Specification: VDE 0816 or Technical agreement

Application

- » connection cables in Local Area Networks
- » to be placed in cable ducts, under ground laying and areas without higher danger of mechanical cable damage

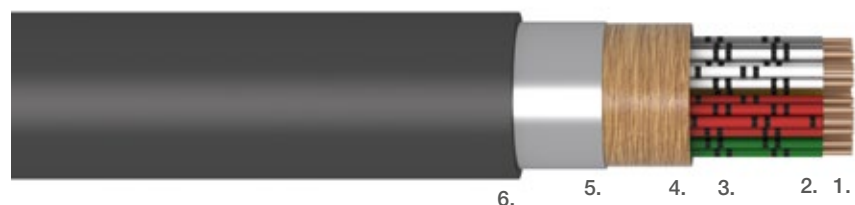

Description of materials:

1. Copper wire.
2. Core insulation – foam skin PE.
3. Filling material.
4. Crepe paper.
5. Laminated aluminium foil.
6. PE outer jacket, black.

Transmission element – each 4 cores are twisted a star quad, the quads are stranded to units, the units are stranded to the cable core. Cable core is filled.

Environmental conditions

Temperature ranges for laying and assembly	-10 °C ÷ +60 °C
Operation and store temperatures	-20 °C ÷ +50 °C
Permitted minimum bending radius	min. 10D
Cable lifetime	min. 30 years

D – outside cable diameter

Rings identify the individual conductors

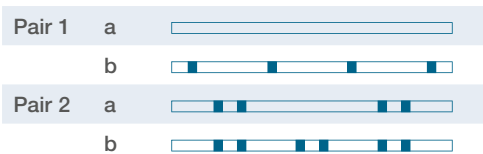

Electrical parameters (20 °C)

Conductor diameter	mm	0.4 (H50)	0.5 (H42)	0.6 (H42)	0.6 (H52)	0.8 (H42)	0.8 (H55)
Max. loop resistance	Ω/km	300.0	196.0	130.0	130.0	73.2	73.2
Insulation resistance min.	GΩ.km	1.5	1.5	1.5	1.5	1.5	1.5
Mutual capacitance	nF/km	50	42	42	52	42	55
Capacity unbalance k ₁	dB/km	800	800	800	800	800	800
Test voltage wire/wire at 50 Hz	V	500	500	500	500	500	500
Test voltage wire/shield at 50 Hz	V	2,000	2,000	2,000	2,000	2,000	2,000
Operating voltage max.	V _{ss}	150	150	225	225	225	225

Packing on drums.

Number of units	Wire/core diameter H42 0.5/1.05 mm			Wire/core diameter H42 0.6/1.30 mm			Wire/core diameter H42 0.8/1.70 mm		
	External diameter [mm]	Net weight [kg/km]	Standard production length [m]	External diameter [mm]	Net weight [kg/km]	Standard production length [m]	External diameter [mm]	Net weight [kg/km]	Standard production length [m]
2	7.8	70	2,000	8.5	80	2,000	9.4	100	2,000
4	9.4	100	2,000	10.5	120	2,000	12.1	160	2,000
6	10.2	115	2,000	11.3	145	2,000	13.3	200	2,000
10	11.6	155	2,000	13.2	195	2,000	15.7	290	2,000
20	14.0	230	2,000	16.4	315	2,000	20.5	500	2,000
30	15.9	310	2,000	18.9	425	2,000	23.3	670	2,000
40	17.6	385	2,000	21.1	535	2,000	26.5	870	2,000
50	19.2	460	2,000	22.9	640	2,000	28.9	1,045	2,000
70	21.5	595	2,000	26.2	865	2,000	33.7	1,440	2,000
100	25.0	815	2,000	30.7	1,190	2,000	39.1	1,965	1,000
150	30.0	1,190	2,000	37.0	1,740	2,000	47.8	2,950	1,000
200	34.7	1,580	2,000	41.7	2,245	1,000	54.0	3,815	1,000
250	38.0	1,925	2,000	46.7	2,815	1,000	60.2	4,755	500
300	41.0	2,265	1,000	50.4	3,315	1,000	65.3	5,640	500
350	43.8	2,600	1,000	53.7	3,795	1,000			
400	47.1	2,995	1,000	57.9	4,370	500			
500	51.8	3,660	1,000	65.0	5,480	500			
600	57.7	4,500	500						
700	60.7	5,085	500						

Number of units	Wire/core diameter H50 0.4/0.73 mm			Wire/core diameter H52 0.6/1.05 mm			Wire/core diameter H55 0.8/1.38 mm		
	External diameter [mm]	Net weight [kg/km]	Standard production length [m]	External diameter [mm]	Net weight [kg/km]	Standard production length [m]	External diameter [mm]	Net weight [kg/km]	Standard production length [m]
2	7.1	60	2,000	7.8	75	2,000	8.6	90	2,000
4	8.3	75	2,000	9.4	105	2,000	11.0	145	2,000
6	8.7	90	2,000	10.2	125	2,000	12.1	180	2,000
10	9.5	105	2,000	11.6	170	2,000	13.6	245	2,000
20	11.3	160	2,000	14.0	265	2,000	17.1	410	2,000
30	12.7	205	2,000	15.9	355	2,000	19.8	565	2,000
40	13.8	250	2,000	17.6	445	2,000	24.2	725	2,000
50	14.9	295	2,000	19.2	535	2,000	24.6	890	2,000
70	16.6	380	2,000	21.5	705	2,000	28.0	1,205	2,000
100	18.7	500	2,000	25.0	970	2,000	32.1	1,640	2,000
150	22.2	720	2,000	30.0	1,430	2,000	38.6	2,415	2,000
200	25.2	935	2,000	34.7	1,895	2,000	45.4	3,265	1,000
250	27.5	1,140	2,000	38.0	2,325	2,000	51.0	4,110	1,000
300	29.6	1,340	2,000	41.0	2,740	1,000	56.9	5,005	500
350				43.8	3,160	1,000	60.9	5,775	500
400	34.5	1,795	2,000	47.1	3,630	1,000	64.4	6,535	500
500	37.5	2,170	2,000	51.8	4,455	1,000			
600	40.8	2,595	1,000	57.7	5,455	500			
700	43.5	2,980	1,000	60.7	6,200	500			
800	46.8	3,420	1,000	65.7	7,100	500			
1,000	51.5	4,220	1,000						
1,200	56.5	5,050	500						

A-2YF(L)2Y

...x2x0.6 (0.8) ST III BD (H52; H55)

Specification: VDE 0816

Application

- » connection cables in Local Area Networks and in private branch exchanges for telephony and signal transfer
- » suitable for placement as underground and conduit cables

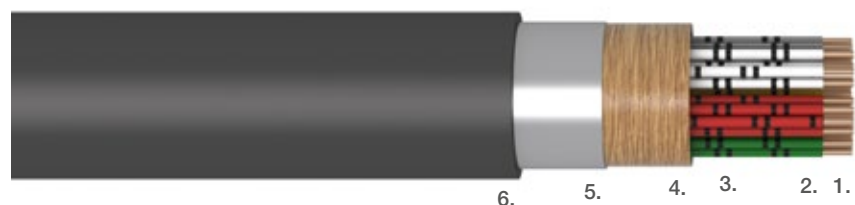

Description of materials:

1. Copper wire.
2. Core insulation – solid PE.
3. Filling material.
4. Crepe paper.
5. Laminated aluminium foil.
6. PE outer jacket, black.

Transmission element – each 4 cores are twisted a star quad, the quads are stranded to units, the units are stranded to the cable core. Cable core is filled.

Environmental conditions

Temperature ranges for laying and assembly	-10 °C ÷ +60 °C
Operation and store temperatures	-40 °C ÷ +70 °C
Permitted minimum bending radius	min. 10D
Cable lifetime	min. 30 years

D – outside cable diameter

Rings identify the individual conductors

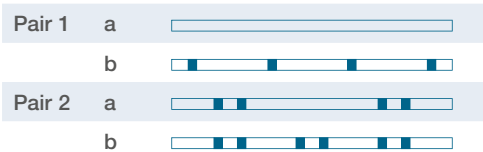

Electrical parameters (20 °C)

	mm	0.6	0.8
Conductor diameter	mm	0.6	0.8
Max. loop resistance	Ω/km	130.0	73.2
Insulation resistance min.	GΩ.km	1.5	1.5
Mutual capacitance	nF/km	52	55
Effective test voltage wire/wire at 50 Hz	V	500	500
Effective test voltage wire/shield at 50 Hz	V	2,000	2,000
Operating voltage max.	V _{ss}	225	225

Packing on drums.

Number of units	Wire/core diameter H52 0.6/1.3 mm			Wire/core diameter H55 0.8/1.6 mm		
	External diameter [mm]	Net weight [kg/km]	Standard production length [m]	External diameter [mm]	Net weight [kg/km]	Standard production length [m]
2	9.0	80	2,000	10.0	100	2,000
4	13.0	150	2,000	14.5	195	2,000
6	12.0	140	2,000	13.5	200	2,000
10	13.5	190	2,000	15.5	280	2,000
20	16.5	315	2,000	20.0	485	2,000
30	19.5	440	2,000	23.0	675	2,000
40	21.5	555	2,000	26.5	885	2,000
50	23.5	670	2,000	28.5	1,070	2,000
70	27.0	910	2,000	33.0	1,445	2,000
100	31.5	1,245	2,000	38.5	2,015	2,000
150	38.5	1,835	2,000	47.5	3,010	1,000
200	43.0	2,375	1,000	54.0	3,920	500
250	48.5	2,975	1,000	60.0	4,890	500
300	52.0	3,505	1,000	64.5	5,780	500
400	58.4	4,080	500			
500	64.0	5,010	500			

A-02Y(L)2Y

...x2x0.5 ST III BD (H42)

Specification: Technical Agreement

Application

- » connection cables in Local Area Networks and in private branch exchanges for telephony and signal transfer
- » suitable for placement as underground and conduit cables

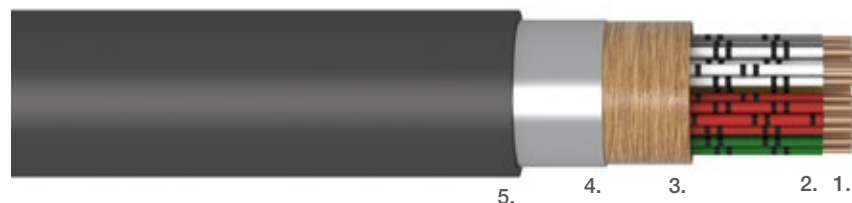

Description of materials:

1. Copper wire.
2. Core insulation – foam skin PE.
3. Crepe paper.
4. Laminated aluminium foil.
5. PE outer jacket, black.

Transmission element – star quads twisted to unit.

Environmental conditions

Temperature ranges for laying and assembly	-10 °C ÷ +60 °C
Operation and store temperatures	-40 °C ÷ +70 °C
Permitted minimum bending radius	min. 10D
Cable lifetime	min. 30 years

D – outside cable diameter

Electrical parameters (20 °C)

Conductor diameter	mm	0.5
Max. loop resistance	Ω/km	196.0
Insulation resistance min.	GΩ.km	5
Mutual capacitance	nF/km	42
Effective test voltage wire/wire at 50 Hz	V	500
Effective test voltage wire/shield at 50 Hz	V	2,000
Operating voltage max.	Vss	150

Packing on drums.

Wire/core diameter H42 0.5/0.8 mm

Number of units	External diameter [mm]	Net weight [kg/km]	Standard production length [m]
2	9.4	70	2,000
4	11.1	95	2,000
6	11.6	105	2,000
10	12.5	120	2,000
20	15.1	180	2,000
30	16.8	220	2,000
40	18.1	255	2,000
50	19.1	270	2,000
70	21.2	310	2,000
100	23.9	580	2,000
150	28.3	750	2,000
200	31.4	950	2,000
250	34.0	1,200	2,000
300	36.8	1,350	2,000
400	39.0	1,400	2,000
500	41.1	1,750	1,000
600	44.9	1,900	1,000
700	49.2	2,200	1,000
800	52.9	2,620	1,000
1,000	63.7	4,250	500

Rings identify the individual conductors

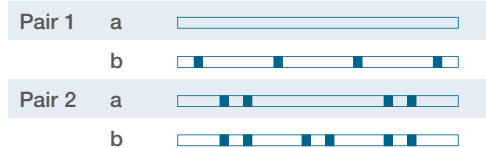

A-2Y(L)2Y

...x2x0.6 (0.8) ST III BD (H52; H55)

Specification: Technical Agreement

Application

- » connection cables in Local Area Networks and in private branch exchanges for telephony and signal transfer
- » suitable for placement as underground and conduit cables

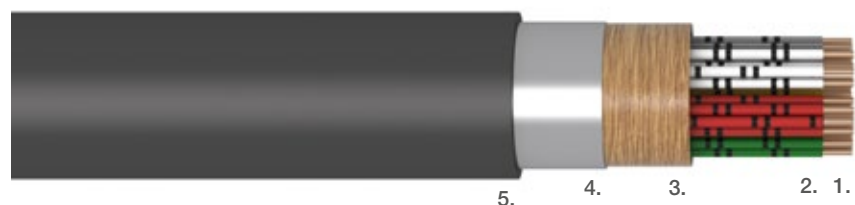

Description of materials:

1. Copper wire.
2. Core insulation – solid PE.
3. Crepe paper.
4. Laminated aluminium foil.
5. PE outer jacket, black.

Transmission element – star quads twisted to units.

Number of units	Wire/core diameter H52 0.6/1.1 mm			Wire/core diameter H55 0.8/1.4 mm		
	External diameter [mm]	Net weight [kg/km]	Standard production length [m]	External diameter [mm]	Net weight [kg/km]	Standard production length [m]
2	11.5	130	2,000	8.2	69	2,000
4	12.5	165	2,000	10.5	107	2,000
6	15.5	265	2,000	13.0	175	2,000
10	17.5	355	2,000	14.5	235	2,000
20	19.5	440	2,000	18.0	390	2,000
30	21.0	525	2,000	21.0	540	2,000
40	24.5	705	2,000	23.0	680	2,000
50	28.0	950	2,000	25.5	835	2,000
70	32.5	1,345	2,000	29.0	1,110	2,000
100	37.0	1,755	2,000	33.5	1,515	2,000
150	40.5	2,140	2,000	40.0	2,205	2,000
200	44.0	2,525	2,000	46.5	2,920	1,000
250	48.0	2,950	2,000	51.0	3,575	1,000
300	50.5	3,340	1,000	55.0	4,230	1,000
400	55.5	4,090	1,000	62.5	5,595	500
500	60.5	4,910	1,000	70.0	6,960	500
600	64.5	5,655	750	76.0	8,250	333
700	69.5	6,500	750			
800	76.5	7,970	500			
1,000	83.5	9,545	500			

Environmental conditions

Temperature ranges for laying and assembly	-10 °C ÷ +60 °C
Operation and store temperatures	-40 °C ÷ +70 °C
Permitted minimum bending radius	min. 10D
Cable lifetime	min. 30 years

D – outside cable diameter

Rings identify the individual conductors



Electrical parameters (20 °C)

Parameter	Unit	0.6 mm	0.8 mm
Conductor diameter	mm	0.6	0.8
Max. loop resistance	Ω/km	130.0	73.2
Insulation resistance min.	GΩ.km	1.5	1.5
Mutual capacitance	nF/km	52	55
Effective test voltage wire/wire at 50 Hz	V	500	500
Effective test voltage wire/shield at 50 Hz	V	2,000	2,000
Operating voltage max.	V _{ss}	225	225

Packing on drums.

TK 59 GM

...x4x0.4 (0.6; 0.8)

Specification: PTT 7/81

Application

- » local network
- » can be laid into cable duct and directly into ground

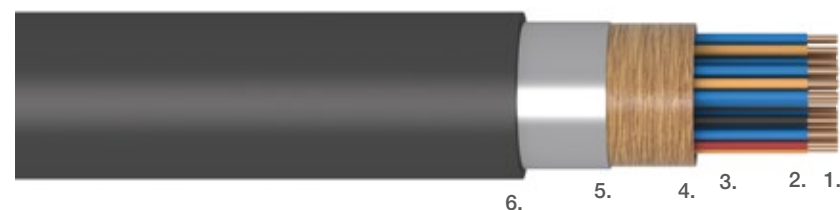

Description of materials:

1. Copper wire.
2. Core insulation – foam skin PE.
3. Filling material.
4. Crepe paper.
5. Laminated aluminium foil.
6. PE outer jacket, black.

Transmission element – each 4 cores are twisted a star quad, the quads are stranded to units, the units are stranded to the cable core. Cable core is filled.

Environmental conditions

Temperature ranges for laying and assembly	-10 °C ÷ +60 °C
Operation and store temperatures	-40 °C ÷ +70 °C
Permitted minimum bending radius	min. 10D
Cable lifetime	min. 30 years

D – outside cable diameter

Electrical parameters (20 °C)

Conductor diameter	mm	0.4	0.6	0.8
Max. loop resistance	Ω/km	300.0	130.0	72.0
Insulation resistance min.	GΩ.km	min. 5	min. 5	min. 5
Mutual capacitance	nF/km	38	42	42
Capacity unbalance k_1 at 800 Hz	pF/500 m	800	800	300
Effective test voltage wire/wire at 50 Hz	V	500	500	500
Effective test voltage wire/shield at 50 Hz	V	2,000	2,000	2,000
Operating voltage max.	V _{ss}	250	250	250

Packing on drums.

Number of units	Wire/core diameter 0.4/0.99 mm			Wire/core diameter 0.6/1.33 mm			Wire/core diameter 0.8/1.75 mm		
	External diameter [mm]	Net weight [kg/km]	Standard production length [m]	External diameter [mm]	Net weight [kg/km]	Standard production length [m]	External diameter [mm]	Net weight [kg/km]	Standard production length [m]
1	7.7	47	2,000	8.5	61	2,000	9.5	80	2,000
3	11	98	2,000	13	146	2,000	14.3	190	2,000
5	11.7	116	2,000	13.6	173	2,000	16.6	269	2,000
10	13.5	165	2,000	16.5	274	2,000	19.4	410	2,000
15	15.8	229	2,000	19.6	393	2,000	23.4	602	2,000
20	17.2	279	2,000	21.4	485	2,000	26.9	798	2,000
25	18.3	323	2,000	23.8	602	2,000	29.7	980	1,000
30	19.9	383	2,000	25.3	693	2,000	31.8	1,142	1,000
35	21.1	434	2,000	26.9	792	2,000	33.9	1,310	1,000
40	22.2	485	2,000	28.4	890	1,000	36.2	1,495	1,000
50	23.2	550	2,000	31.2	1,087	1,000	39.5	1,812	1,000
60	–	–	2,000	33.3	1,261	1,000	42.5	2,127	1,000
75	27.9	803	2,000	37	1,564	1,000	46.8	2,609	500
100	31.4	1,033	1,000	41.6	2,016	1,000	59.5	3,919	500
125	34.8	1,275	1,000	46.8	2,540	500	66.2	4,869	500
150	38.2	1,533	1,000	51.6	3,071	500			
175	40.8	1,761	1,000	55.2	3,539	500			
200	41.1	1,860	1,000	59.3	4,070	500			
225	43.2	2,068	500	62.4	4,533	500			
250	48.1	2,470	500	66.6	5,113	500			
300	52.1	2,918	500						
350	56.5	3,424	500						
400	61.8	4,033	500						
500	67.9	4,925	500						

TK 53 UM (aerial)

...x4 (0.6; 0.8)

Specification: TDO 18/08

Application

- » for basic phone services in analogue and digital transmission systems
- » for aerial use

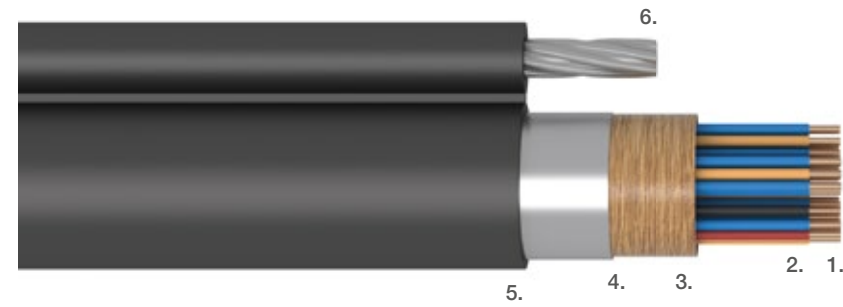

Description of materials:

1. Copper wire.
2. Core insulation – foam skin PE.
3. Crepe paper.
4. Laminated aluminium foil.
5. PE outer jacket, black.
6. Steel wire messenger.

Transmission element – each 4 cores are twisted a star quad, the quads are stranded to units, the units are stranded to the cable core.

Environmental conditions

Temperature ranges for laying and assembly	-10 °C ÷ +60 °C
Operation and store temperatures	-40 °C ÷ +70 °C
Permitted minimum bending radius	min. 10D
Cable lifetime	min. 30 years

D – outside cable diameter

Electrical parameters (20 °C)

Parameter	Unit	0.6	0.8
Conductor diameter	mm	0.6	0.8
Max. loop resistance	Ω/km	130.0	72.0
Insulation resistance min.	GΩ.km	min. 5	min. 5
Mutual capacitance	nF/km	42	42
Capacity unbalance k_1 at 800 Hz	pF/500 m	800	300
Effective test voltage wire/wire at 50 Hz	V	500	500
Effective test voltage wire/shield at 50 Hz	V	2,000	2,000
Operating voltage max.	V _{ss}	250	250

Packing on drums.

Number of units	Wire/core diameter 0.6/1.33 mm				Wire/core diameter 0.8/1.75 mm			
	External diameter [mm]	External diameter steel rope (mm)	Net weight [kg/km]	Standard production length [m]	External diameter [mm]	External diameter steel rope (mm)	Net weight [kg/km]	Standard production length [m]
1	8.5	2.15	86	2,000	9.5	2.15	105	2,000
3	13	2.15	171	1,000	14.3	3.0	240	1,000
5	13.6	3.0	223	1,000	16.6	4.15	360	1,000
10	16.5	4.15	365	1,000	19.4	4.15	501	1,000
15	19.6	4.15	484	1,000	23.4	4.15	693	1,000
20	21.4	4.15	576	1,000	26.9	5.0	913	1,000
25	23.8	5.0	717	1,000	29.7	6.0	1,095	1,000

HRQHQZKAHQ (Qv – jelly filled)

...x4x0.4 (0.6; 0.8)

Specification: MMD-59V5

Application

- » for basic phone services in analogue and digital transmission systems
- » to be placed in cable ducts, under ground laying and areas without higher danger of mechanical cable damage

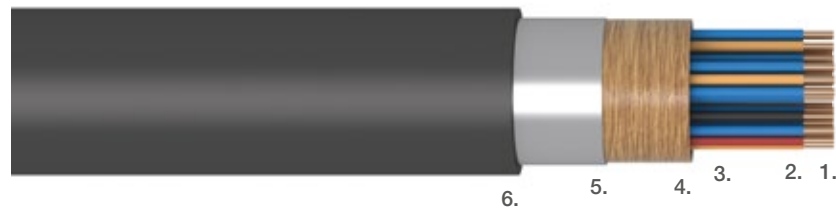

Description of materials:

1. Copper wire.
2. Core insulation – foam skin PE.
3. Filling material.
4. Crepe paper.
5. Laminated aluminium foil.
6. PE outer jacket, black.

Transmission element – each 4 cores are twisted a star quad, the quads are stranded to units, the units are stranded to the cable core. Cable core is filled.

Environmental conditions

Temperature ranges for laying and assembly	0 °C ÷ +40 °C
Operation and store temperatures	-30 °C ÷ +50 °C
Permitted minimum bending radius	min. 10D
Cable lifetime	min. 30 years

D – outside cable diameter

Electrical parameters (20 °C)

Conductor diameter	mm	0.4	0.6	0.8
Max. loop resistance	Ω/km	300.0	133.0	73.2
Insulation resistance min.	GΩ.km	min. 10	min. 10	min. 10
Mutual capacitance	nF/km	43 ± 3	43 ± 3	43 ± 3
Capacity unbalance k ₁ at 800 Hz	pF/500 m	800	800	800
Effective test voltage wire/wire at 50 Hz	V	600	600	600
Effective test voltage wire/shield at 50 Hz	V	2,000	2,000	2,000
Operating voltage max.	V _{ss}	250	250	250

Packing on drums.

Number of units	Wire/core diameter 0.4/0.74 mm			Wire/core diameter 0.6/1.33 mm			Wire/core diameter 0.8/1.45 mm		
	External diameter [mm]	Net weight [kg/km]	Standard production length [m]	External diameter [mm]	Net weight [kg/km]	Standard production length [m]	External diameter [mm]	Net weight [kg/km]	Standard production length [m]
3	8.7	66	2,000	10	96	2,000	12.1	151	2,000
5	9.2	80	2,000	11.7	138	2,000	14.6	229	2,000
10	11.2	128	2,000	14.1	222	2,000	17	358	2,000
15	13.1	180	2,000	16.8	321	2,000	20.1	514	2,000
25	15.4	264	2,000	19.6	471	2,000	25.6	843	2,000
35	16.6	329	2,000	22.6	640	2,000	29.1	1,129	2,000
50	20.1	476	2,000	26.6	897	2,000	33.1	1,530	2,000
75	22.1	629	2,000	30.8	1,264	2,000	40	2,263	1,000
100	26.4	871	2,000	35.2	1,666	1,000	46.4	3,031	1,000
150	29.7	1,188	2,000	41.3	2,388	1,000	56.4	4,511	500
200	34	1,568	1,000	48.2	3,219	1,000	64	5,907	500
300	42.7	2,415	1,000	58.7	4,800	500			
400	47.4	3,089	1,000	67.5	6,244	500			
500	52.2	3,799	500						
600	56.4	4,497	500						
800	67.5	6,216	500						

HRQHQZKAHQ – AkVQ (Qvr – armoured)

...x4x0.4 (0.6; 0.8)

Specification: MMD59V5

Application

- » for basic phone services in analogue and digital transmission systems
- » to be placed in cable ducts, under ground laying and areas without higher danger of mechanical cable damage

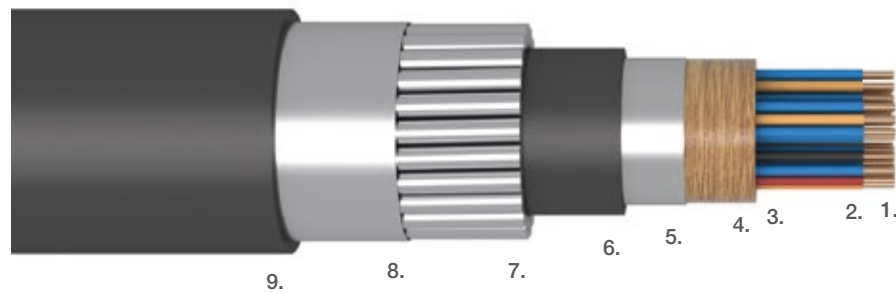

Description of materials:

1. Copper wire.
2. Core insulation – foam skin PE.
3. Filling material.
4. Crepe paper.
5. Laminated aluminium foil.
6. PE inner jacket, black.
7. Armouring Alu wire.
8. Fe/Zn tape.
9. PE outer jacket, black.

Transmission element – each 4 cores are twisted a star quad, the quads are stranded to units, the units are stranded to the cable core.

Number of units	Wire/core diameter 0.4/0.74 mm			Wire/core diameter 0.6/1.33 mm			Wire/core diameter 0.8/1.45 mm		
	External diameter [mm]	Net weight [kg/km]	Standard production length [m]	External diameter [mm]	Net weight [kg/km]	Standard production length [m]	External diameter [mm]	Net weight [kg/km]	Standard production length [m]
5	20.6	266	2,000	23.1	359	2,000	26	495	2,000
10	22.6	339	2,000	25.5	485	2,000	28.4	680	2,000
15	24.5	430	2,000	28.2	628	2,000	31.5	876	1,000
25	26.8	542	2,000	31	830	1,000	38.4	1,432	1,000
35	28	642	2,000	35.4	1,140	1,000	41.9	1,763	1,000
50	31.5	838	1,000	39.4	1,492	1,000	47.7	2,374	500
75	34.9	1,115	1,000	45.4	2,022	500	54.6	3,281	500
100	39.2	1,464	1,000	49.8	2,527	500	61.8	4,282	500
150	42.5	1,879	1,000	56.7	3,490	500	73	5,971	500
200	48.6	2,420	500	63.6	4,503	500	80.6	7,539	250
300	58.1	3,718	500						
400	62.8	4,520	500						
500	68.8	5,360	500						
600	73	6,181	500						
800	84.1	8,154	250						

Environmental conditions

Temperature ranges for laying and assembly	0 °C ÷ +40 °C
Operation and store temperatures	-30 °C ÷ +50 °C
Permitted minimum bending radius	min. 10D
Cable lifetime	min. 30 years

D – outside cable diameter

Electrical parameters (20 °C)

Conductor diameter	mm	0.4	0.6	0.8
Max. loop resistance	Ω/km	300.0	133.0	73.2
Insulation resistance min.	GΩ.km	min. 10	min. 10	min. 10
Mutual capacitance	nF/km	43 ± 3	43 ± 3	43 ± 3
Capacity unbalance k ₁ at 800 Hz	pF/500 m	800	800	800
Effective test voltage wire/wire at 50 Hz	V	600	600	600
Effective test voltage wire/shield at 50 Hz	V	2,000	2,000	2,000
Operating voltage max.	V _{ss}	250	250	250

Packing on drums.

LRQHQAHQ (QI – aerial)

...x4x0.6 (0.8)

Specification: MMD59V5

Application

- » for basic phone services in analogue and digital transmission systems
- » for aerial use



Description of materials:

1. Copper wire.
2. Core insulation – solid PE.
3. Wrapping plastic tape.
4. Laminated aluminium foil.
5. PVC outer jacket, black.
6. Steel wire messenger.

Transmission element – each 4 cores are twisted a star quad, the quads are stranded to units, the units are stranded to the cable core.

Environmental conditions

Temperature ranges for laying and assembly	0 °C ÷ +40 °C
Operation and store temperatures	-30 °C ÷ +50 °C
Permitted minimum bending radius	min. 10D
Cable lifetime	min. 30 years

D – outside cable diameter

Electrical parameters (20 °C)

	mm	0.6	0.8
Conductor diameter	mm	0.6	0.8
Max. loop resistance	Ω/km	130.0	73.2
Insulation resistance min.	GΩ.km	min. 10	min. 10
Mutual capacitance	nF/km	43 ± 3	43 ± 3
Capacity unbalance k_1 at 800 Hz	pF/500 m	800	800
Effective test voltage wire/wire at 50 Hz	V	600	600
Effective test voltage wire/shield at 50 Hz	V	2,000	2,000
Operating voltage max.	V _{ss}	250	250

Packing on drums.

Number of units	Wire/core diameter 0.6/1.0 mm				Wire/core diameter 0.8/1.35 mm			
	External diameter [mm]	External diameter steel rope (mm)	Net weight [kg/km]	Standard production length [m]	External diameter [mm]	External diameter steel rope (mm)	Net weight [kg/km]	Standard production length [m]
3	9.9	2.55	117	2,000	11.8	2.55	156	2,000
5	11.4	3	161	2,000	13.8	3	209	2,000
10	13.5	3.6	256	2,000	17	3.6	340	1,000
15	15.8	3.6	329	1,000				
25	18.5	3.6	464	1,000				
50	24.9	4.2	834	1,000				

CW 1128, CW 1128/1179

...x2x0.4 (0.5; 0.6; 0.63; 0.9)

Specification: CW1128/1179

Application

- » connection cables in Local Area Networks and in private branch exchanges for telephony and signal transfer
- » suitable for placement as underground and conduit cables

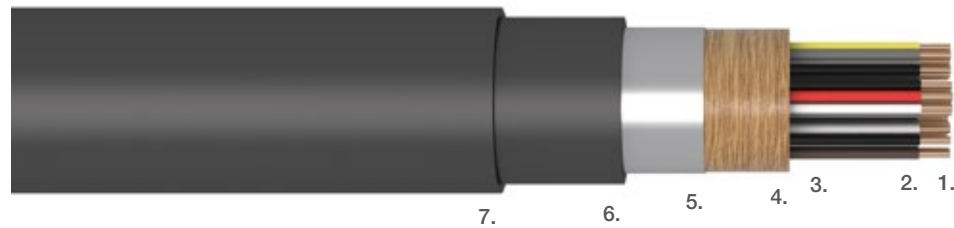

Description of materials:

1. Copper wire.
2. Core insulation – foam skin PE.
3. Filling material.
4. Crepe paper.
5. Laminated aluminium foil.
6. PE inner jacket, black.
7. PE outer jacket, black.

Twin pair twisted to units. Cable core is filled.

Environmental conditions

Temperature ranges for laying and assembly	-10 °C ÷ +60 °C
Operation and store temperatures	-40 °C ÷ +70 °C
Permitted minimum bending radius	min. 10D
Cable lifetime	min. 30 years

D – outside cable diameter

Electrical parameters (20 °C)

	mm	0.4	0.5	0.6	0.63	0.9
Conductor diameter	mm	0.4	0.5	0.6	0.63	0.9
Max. loop resistance	Ω/km	143	91	63	58	28
Insulation resistance min.	GΩ.km	1.5	1.5	1.5	1.5	1.5
Mutual capacitance	nF/km	56	56	42	56	59
Effective test voltage wire/wire at 50 Hz	V	500	500	500	500	500
Effective test voltage wire/shield at 50 Hz	V	2,000	2,000	2,000	2,000	2,000

Packing on drums.

Design code CW1128

Number of units	Wire/core diameter 0.4/0.75 mm		Wire/core diameter 0.5/0.9 mm		Wire/core diameter 0.6/1.30 mm		Wire/core diameter 0.63/1.15 mm		Wire/core diameter 0.9/1.5 mm	
	External diameter [mm]	Standard production length [m]	External diameter [mm]	Standard production length [m]	External diameter [mm]	Standard production length [m]	External diameter [mm]	Standard production length [m]	External diameter [mm]	Standard production length [m]
2			7.5	1,000	8.5	1,000	8.0	1,000	9.0	1,000
4	8.7	1,000	7.8	1,000	10.5	1,000	9.0	1,000	11.0	1,000
5	9.0	1,000	8.0	1,000	11.0	1,000	9.5	1,000	11.5	1,000
10	10.0	1,000	9.5	1,000	13.0	1,000	11.5	1,000	14.0	1,000
20	11.5	1,000	12.0	1,000	16.0	1,000	14.0	1,000	18.0	1,000
50	15.5	1,000	16.5	1,000	24.0	1,000	20.5	1,000	26.5	1,000
100	20.0	1,000	22.0	1,000	32.0	1,000	27.5	1,000	36.0	1,000

Design code CW1128/1179

Number of units	Wire/core diameter 0.4/0.75 mm		Wire/core diameter 0.5/0.9 mm		Wire/core diameter 0.6/1.30 mm		Wire/core diameter 0.63/1.15 mm		Wire/core diameter 0.9/1.5 mm	
	External diameter [mm]	Standard production length [m]	External diameter [mm]	Standard production length [m]	External diameter [mm]	Standard production length [m]	External diameter [mm]	Standard production length [m]	External diameter [mm]	Standard production length [m]
2			9.0	1,000	10.0	1,000	9.5	1,000	10.5	1,000
4	8.7	1,000	9.3	1,000	12.0	1,000	10.5	1,000	12.5	1,000
5	9.0	1,000	9.5	1,000	12.5	1,000	11.0	1,000	13.0	1,000
10	10.0	1,000	11.0	1,000	14.5	1,000	13.0	1,000	15.5	1,000
20	11.5	1,000	13.5	1,000	17.5	1,000	15.5	1,000	19.5	1,000
50	15.5	1,000	18.0	1,000	25.5	1,000	22.0	1,000	28.0	1,000
100	20.0	1,000	23.5	1,000	33.5	1,000	29.0	1,000	37.5	1,000

CW 1171/CW 1179

...x2x0.4 (0.5; 0.63; 0.9)

Specification: BT CW1171 and CW 1179

Application

- » connection cables in Local Area Networks and in private branch exchanges for telephony and signal transfers
- » suitable for placement as under ground and conduit cables

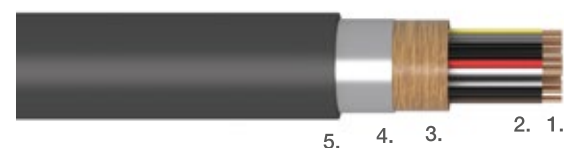

Description of materials:

1. Copper wire.
2. Core insulation – foam skin.
3. Crepe paper.
4. Laminated aluminium foil.
5. PE outer jacket, black.

Transmission element – pair.

Environmental conditions

Temperature ranges for laying and assembly	-10 °C ÷ +60 °C
Operation and store temperatures	-40 °C ÷ +70 °C
Permitted minimum bending radius	min. 10D
Cable lifetime	min. 30 years

D – outside cable diameter

Electrical parameters (20 °C)

	mm	0.4	0.5	0.63	0.9
Conductor diameter	mm	0.4	0.5	0.63	0.9
Max. loop resistance	Ω/km	143	91	58	28
Insulation resistance min.	GΩ.km	6.5	6.5	6.5	6.5
Mutual capacitance	nF/km	53	53	56	59

Packing on drums.

Design code CW1171/1179

Number of units	Wire/core diameter 0.4/0.75 mm		Wire/core diameter 0.5/0.9 mm		Wire/core diameter 0.63/1.15 mm		Wire/core diameter 0.9/1.50 mm	
	External diameter [mm]	Standard production length [m]	External diameter [mm]	Standard production length [m]	External diameter [mm]	Standard production length [m]	External diameter [mm]	Standard production length [m]
25	14.0	1,000	16.0	1,000	19.0	1,000	22.5	1,000
50	16.0	1,000	19.0	1,000	22.0	1,000	27.5	1,000
100	20.5	1,000	23.5	1,000	28.0	1,000	37.0	1,000
200	26.0	1,000	30.5	1,000	37.5	1,000	49.2	1,000
300	30.5	1,000	37.0	1,000	46.0	1,000	59.7	500
400	35.0	1,000	42.5	1,000	52.5	1,000	68.2	500
500	37.5	1,000	46.0	1,000	56.5	500	75.6	400
600	40.5	1,000	49.5	1,000	61.0	500		
800	46.5	1,000	56.5	500	70.5	500		
1,000	51.5	1,000	62.5	500	74.9	400		
1,200	56.0	500	69.0	500				
1,600	65.5	500	75.0	400				
2,000	70.0	500						
2,400	75.0	400						

CW 1224/CW 1179

...x2x0.4 (0.5; 0.63; 0.9)

Specification: BT CW1224 and CW 1179

Application

- » connection cables in Local Area Networks and in private branch exchanges for telephony and signal transfers
- » suitable for placement as under ground and conduit cables

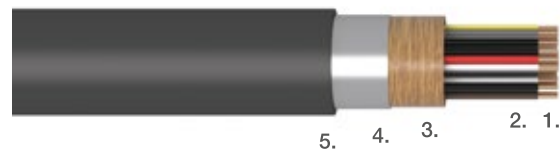

Description of materials:

1. Copper wire.
2. Core insulation – foam skin.
3. Crepe paper.
4. Laminated aluminium foil.
5. PE outer jacket, black.

Transmission element – pair.

Environmental conditions

Temperature ranges for laying and assembly	-10 °C ÷ +60 °C
Operation and store temperatures	-40 °C ÷ +70 °C
Permitted minimum bending radius	min. 10D
Cable lifetime	min. 30 years

D – outside cable diameter

Electrical parameters (20 °C)

	mm	0.4	0.5	0.63	0.9
Conductor diameter	mm	0.4	0.5	0.63	0.9
Max. loop resistance	Ω/km	143	91	58	28
Insulation resistance min.	GΩ.km	6.5	6.5	6.5	6.5
Mutual capacitance	nF/km	53	53	56	59

Packing on drums.

Design code CW1224/1179

Number of units	Wire/core diameter 0.4/0.70 mm		Wire/core diameter 0.5/0.80 mm		Wire/core diameter 0.63/0.98 mm		Wire/core diameter 0.90/1.35 mm	
	External diameter [mm]	Standard production length [m]	External diameter [mm]	Standard production length [m]	External diameter [mm]	Standard production length [m]	External diameter [mm]	Standard production length [m]
50	15.5	1,000	17.0	1,000	19.5	1,000	24.5	1,000
100	19.0	1,000	22.0	1,000	25.0	1,000	32.5	1,000
200	24.5	1,000	28.5	1,000	33.5	1,000	45.0	1,000
300	28.5	1,000	33.5	1,000	39.5	1,000	56.0	500
400	32.5	1,000	37.5	1,000	44.5	1,000	62.0	500
500	35.5	1,000	41.5	1,000	49.5	1,000		
600	38.5	1,000	44.5	1,000	53.5	500		
800	44.0	1,000	51.5	1,000	61.0	500		
1,000	48.5	1,000	56.0	500	67.5	500		
1,200	52.5	1,000	61.5	500	73.5	500		
1,600	60.0	500	69.5	500				
2,000	66.5	500	75.0	400				
2,400	72.5	500						

CW 1236, CW 1236/CW 1179

...x2x0.4 (0.5; 0.63; 0.9)

Specification: BT CW1236 and CW 1179

Application

- » connection cables in Local Area Networks and in private branch exchanges for telephony and signal transfers
- » suitable for placement as under ground and conduit cables

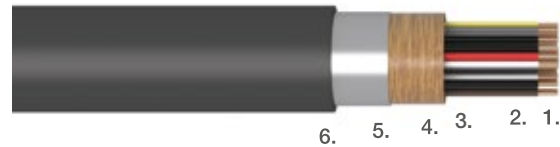

Description of materials:

1. Copper wire.
2. Core insulation – foam skin.
3. Filling material.
4. Crepe paper.
5. Laminated aluminium foil.
6. PE outer jacket, black.

Transmission element – pair.

Environmental conditions

Temperature ranges for laying and assembly	-10 °C ÷ +60 °C
Operation and store temperatures	-40 °C ÷ +70 °C
Permitted minimum bending radius	min. 10D
Cable lifetime	min. 30 years

D – outside cable diameter

Electrical parameters (20 °C)

	mm	0.4	0.5	0.63	0.9
Conductor diameter	mm	0.4	0.5	0.63	0.9
Max. loop resistance	Ω/km	143	91	58	28
Insulation resistance min.	GΩ.km	1.5	1.5	1.5	1.5
Mutual capacitance	nF/km	56	56	56	59
Effective test voltage wire/wire at 50 Hz	V	500	500	500	500
Effective test voltage wire/shield at 50 Hz	V	2,000	2,000	2,000	2,000

Packing on drums.

Design code CW 1236

Number of units	Wire/core diameter 0.4/0.75 mm		Wire/core diameter 0.5/0.9 mm		Wire/core diameter 0.63/1.15 mm		Wire/core diameter 0.90/1.50 mm	
	External diameter [mm]	Standard production length [m]	External diameter [mm]	Standard production length [m]	External diameter [mm]	Standard production length [m]	External diameter [mm]	Standard production length [m]
50	16.0	1,000	19.0	1,000	22.0	1,000	27.5	1,000
100	20.5	1,000	23.5	1,000	28.0	1,000	38.0	1,000
200	26.0	1,000	30.5	1,000	37.5	1,000		
300	30.5	1,000	37.0	1,000	46.0	1,000		
400	35.0	1,000	42.5	1,000	52.5	1,000		
500	37.5	1,000	46.0	1,000	56.5	500		
600	40.5	1,000	49.5	1,000	61.0	500		
800	46.5	1,000	56.5	500	70.5	500		
1,000	51.5	1,000	62.5	500				
1,200	56.0	500	69.0	500				
1,600	65.5	500						
2,000	70.0	500						

Design code CW 1236/ CW 1179

Number of units	Wire/core diameter 0.4/0.75 mm		Wire/core diameter 0.5/0.9 mm		Wire/core diameter 0.63/1.15 mm		Wire/core diameter 0.90/1.50 mm	
	External diameter [mm]	Standard production length [m]	External diameter [mm]	Standard production length [m]	External diameter [mm]	Standard production length [m]	External diameter [mm]	Standard production length [m]
50	16.0	1,000	19.0	1,000	22.0	1,000	27.5	1,000
100	20.5	1,000	23.5	1,000	28.0	1,000	38.0	1,000
200	26.0	1,000	30.5	1,000	37.5	1,000		
300	30.5	1,000	37.0	1,000	46.0	1,000		
400	35.0	1,000	42.5	1,000	52.5	1,000		
500	37.5	1,000	46.0	1,000	56.5	500		
600	40.5	1,000	49.5	1,000	61.0	500		
800	46.5	1,000	56.5	500	70.5	500		
1,000	51.5	1,000	62.5	500				
1,200	56.0	500	69.0	500				
1,600	65.5	500						
2,000	70.0	500						

CW 1326, CW 1326/CW 1179

...x2x0.5

Specification: BT CW1326 and CW 1179

Application

- » connection cables in Local Area Networks and in private branch exchanges for telephony and signal transfers
- » suitable for placement as under ground and conduit cables

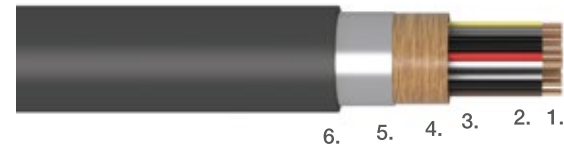

Description of materials:

1. Copper wire.
2. Core insulation – PE.
3. Filling material.
4. Crepe paper.
5. Laminated aluminium foil.
6. PE outer jacket, black.

Transmission element – pair.

Environmental conditions

Temperature ranges for laying and assembly	-10 °C ÷ +60 °C
Operation and store temperatures	-40 °C ÷ +70 °C
Permitted minimum bending radius	min. 10D
Cable lifetime	min. 30 years

D – outside cable diameter

Electrical parameters (20 °C)

Conductor diameter	mm	0.5
Max. loop resistance	Ω/km	91
Insulation resistance min.	GΩ.km	1.5
Mutual capacitance	nF/km	56
Effective test voltage wire/wire at 50 Hz	V	500
Effective test voltage wire/shield at 50 Hz	V	2,000

Packing on drums.

Number of units	Design code CW1326		Design code CW 1326/ CW 1179	
	Wire/core diameter 0.5/1.05 mm		Wire/core diameter 0.5/1.05 mm	
	External diameter [mm]	Standard production length [m]	External diameter [mm]	Standard production length [m]
2	8.5	1,000	10.0	1,000
5	8.5	1,000	10.0	1,000
10	12.0	1,000	13.5	1,000
20	15.0	1,000	16.5	1,000
30	18.0	1,000	19.5	1,000
50	19.5	1,000	21.0	1,000
100	25.0	1,000	26.5	1,000

CW 1600

...x2x0.5

Specification: CW1600

Application

- » connection cables in Local Area Networks and in private branch exchanges for telephony and signal transfers
- » suitable for placement as under ground and conduit cables
- » LIMITED FIRE HAZARD CABLE, fire performance BT Spec. M84

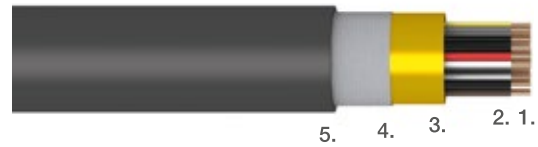

Description of materials:

1. Copper wire.
2. Core insulation – PE.
3. Wrapping ALU/PET tape+CuSn.
4. Flame retardant tape.
5. FRNC outer jacket.

Transmission element – twin pair twisted to units.

Environmental conditions

Temperature ranges for laying and assembly	-10 °C ÷ +60 °C
Operation and store temperatures	-40 °C ÷ +70 °C
Permitted minimum bending radius	min. 10D
Cable lifetime	min. 30 years

D – outside cable diameter

Electrical parameters (20 °C)

Conductor diameter	mm	0.5
Max. loop resistance	Ω/km	97.8
Resistance earth wire	Ω/km	12.4
Insulation resistance min.	GΩ.km	50
Mutual capacitance	nF/km	80
Effective test voltage wire/wire at 50Hz	V	500
Operating voltage	V	500

Packing on drums.

Wire/core diameter 0.5/0.90

Coding	External diameter (mm)
CW 1600 1502H	5.2
CW 1600 1503H	5.5
CW 1600 1504H	6
CW 1600 1506H	7.5
CW 1600 1510H	8.8
CW 1600 1512H	9.1
CW 1600 1525H	11.8
CW 1600 1532H	13.5
CW 1600 1510 EH	9.0
CW 1600 1520 EH	12.0
CW 1600 1540 EH	15.0
CW 1600 1550 EH	18.5
CW 1600 1580 EH	22.5
CW 1600 1581 EH	27.0
CW 1600 1582 EH	30.3
CW 1600 1583 EH	35.0
CW 1600 1584 EH	39.5

TCEPKPFLEZE, TCEPKPFLEZY

...x4x0.4 (0.6; 0.8)

Specification: TP 31.30.13 - KD - 001/94
TP 31.30.13 - KD - 002/94

Application

- » the cables are used for basic phone services in analogue and digital transmission systems
- » the cables are designed to be placed under ground and to areas with higher demands for tensile strength, suspension without supporting rope and laying in areas jeopardized by effects of alternate electromagnetic fields
- » the cables with PVC shield are designed to be placed in areas with fire spread danger

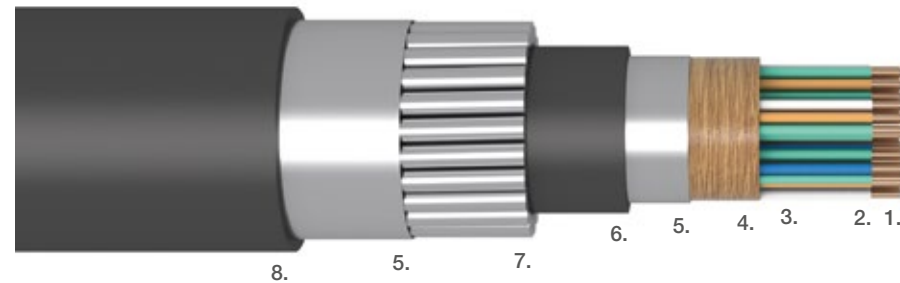

Description of materials:

1. Copper wire.
2. Core insulation – skin foam PE.
3. Filling material.
4. Crepe paper.
5. Fe/Zn tape.
6. PE inner jacker, black.
7. Armor aluminium wires.
8. PE or PVC outer jacket, black.

Transmission element – each 4 cores are twisted a star quad, the quads are stranded to units, the units are stranded to the cable core. Cable core is filled.

Environmental conditions

Temperature ranges for laying and assembly	-10 °C ÷ +60 °C
Operation and store temperatures	-40 °C ÷ +70 °C
Permitted minimum bending radius	min. 10D
Cable lifetime	min. 30 years

D – outside cable diameter

Electrical parameters (20 °C)

Parameter	mm	0.4	0.6	0.8
Conductor diameter	mm	0.4	0.6	0.8
Max. loop resistance	Ω/km	300	133.2	73.6
Insulation resistance min.	GΩ.km	min. 10	min. 10	min. 10
Mutual capacitance	nF/km	max. 49	max. 49	max. 49
Capacity unbalance k ₁ at 800 Hz	pF/500 m	800	800	500
Effective test voltage wire/wire at 50 Hz	V	350	350	350
Effective test voltage wire/shield at 50 Hz	V	700	700	700
Operating voltage max.	V _{ss}	250	250	250

Packing on drums.

Number of units	Design code TCEPKPFLEZE			Design code TCEPKPFLEZE			Design code TCEPKPFLEZE		
	Wire/core diameter 0.4/0.8 mm			Wire/core diameter 0.6/1.2 mm			Wire/core diameter 0.8/1.6 mm		
	External diameter [mm]	Net weight [kg/km]	Standard production length [m]	External diameter [mm]	Net weight [kg/km]	Standard production length [m]	External diameter [mm]	Net weight [kg/km]	Standard production length [m]
3	25.0	440	2,000/D	27.0	540	2,000/B	27.5	600	2,000/B
5	25.5	480	2,000/D	28.0	610	2,000/B	31.0	790	2,000/A
10	27.5	565	2,000/B	30.5	760	2,000/A	33.5	1,025	1,000/D
15	29.5	680	2,000/A	34.0	955	1,000/A	37.0	1,290	1,000/B
20	30.5	755	2,000/A	36.0	1,110	1,000/D	41.0	1,560	1,000/B
25	32.5	825	2,000/A	37.0	1,225	1,000/B	44.0	1,840	1,000/A
35	34.0	965	1,000/A	41.5	1,545	1,000/B	48.5	2,285	500/B
50	37.0	1,195	1,000/B	45.5	1,950	500/A	53.5	2,895	500/B
75	40.5	1,445	1,000/B	50.0	2,500	500/B	60.5	3,950	500/A
100	43.5	1,780	1,000/A	54.5	3,115	500/B	68.0	4,990	250/A
150	48.5	2,310	500/B	61.0	4,160	500/A			
200	51.5	2,800	500/B	69.0	5,320	250/A			
250	55.0	3,300	500/B						
300	60.0	3,950	500/A						
400	68.5	5,125	250/A						
500	73.0	6,005	250/A						

	Design code TCEPKPFLEZY			Design code TCEPKPFLEZY			Design code TCEPKPFLEZY		
	Wire/core diameter 0.4/0.8 mm			Wire/core diameter 0.6/1.2 mm			Wire/core diameter 0.8/1.6 mm		
	External diameter [mm]	Net weight [kg/km]	Standard production length [m]	External diameter [mm]	Net weight [kg/km]	Standard production length [m]	External diameter [mm]	Net weight [kg/km]	Standard production length [m]
3	26.0	530	2,000/D	28.0	640	2,000/B	28.5	700	2,000/B
5	26.5	570	2,000/B	29.0	710	2,000/B	32.0	910	2,000/A
10	28.5	665	2,000/B	31.5	875	2,000/A	34.5	1,150	1,000/D
15	30.5	790	2,000/A	35.0	1,080	1,000/D	38.0	1,435	1,000/B
20	31.5	870	2,000/A	37.0	1,245	1,000/B	42.0	1,720	1,000/A
25	33.5	940	2,000/A	38.0	1,365	1,000/B	45.0	2,015	1,000/A
35	35.0	1,090	1,000/D	42.5	1,700	1,000/A	49.5	2,480	500/B
50	38.0	1,335	1,000/B	46.5	2,125	500/A	54.5	3,105	500/B
75	41.5	1,600	1,000/B	51.0	2,700	500/B	61.5	4,195	500/A
100	44.5	1,945	1,000/A	55.5	3,335	500/B	69.0	5,265	250/A
150	49.5	2,500	500/B	62.0	4,405	250/A			
200	52.5	3,000	500/B	70.0	5,605	250/A			
250	56.0	3,520	500/A						
300	61.0	4,195	500/A						
400	69.5	5,405	250/A						
500	74.0	6,305	250/A						

Drum diameter (mm)

A 2,250	B 2,000	C 1,750	D 1,500	E 1,250	F 1,000
---------	---------	---------	---------	---------	---------

TCEKFLE, TCEKFLEY

...x4x0.4 (0.6; 0.8)

Specification: TP 31.30.13 - KD - 001/94
TP 31.30.13 - KD - 002/94

Application

- » basic phone services in analogue and digital transmission systems
- » to be placed in cable ducts, under ground laying and areas without higher danger of mechanical cable damage
- » with PVC shield to be placed in areas with fire spread danger

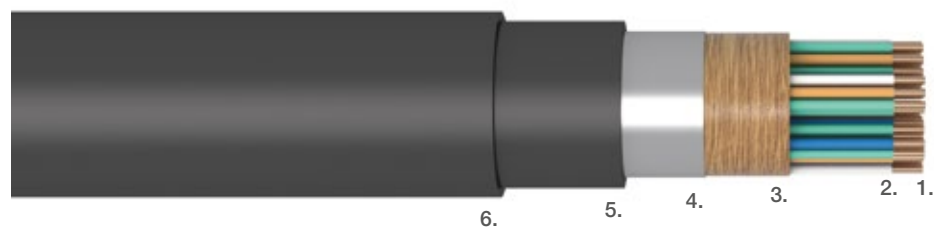

Description of materials:

1. Copper wire.
2. Core insulation – solid PE.
3. Crepe paper.
4. Laminated aluminium foil.
5. PE inner jacket, black.
6. PVC outer jacket, black.

Transmission element – each 4 cores are twisted a star quad, the quads are stranded to units, the units are stranded to the cable core.

Environmental conditions

Temperature ranges for laying and assembly	-10 °C ÷ +60 °C
Operation and store temperatures	-40 °C ÷ +70 °C
Permitted minimum bending radius	min. 10D
Cable lifetime	min. 30 years

D – outside cable diameter

Electrical parameters (20 °C)

	mm	0.4	0.6	0.8
Conductor diameter	mm	0.4	0.6	0.8
Max. loop resistance	Ω/km	300	133.2	73.6
Insulation resistance min.	GΩ.km	min. 10	min. 10	min. 10
Mutual capacitance	nF/km	max. 49	max. 49	max. 49
Capacity unbalance k ₁ at 800 Hz	pF/500 m	800	800	500
Effective test voltage wire/wire at 50 Hz	V	1,000	1,000	1,000
Effective test voltage wire/shield at 50 Hz	V	2,000	2,000	2,000
Operating voltage max.	V _{ss}	250	250	250

Packing on drums.

Number of units	Design code TCEKFLE			Design code TCEKFLE			Design code TCEKFLE		
	Wire/core diameter 0.4/0.9 mm			Wire/core diameter 0.6/1.3 mm			Wire/core diameter 0.8/1.7 mm		
	External diameter [mm]	Net weight [kg/km]	Standard production length [m]	External diameter [mm]	Net weight [kg/km]	Standard production length [m]	External diameter [mm]	Net weight [kg/km]	Standard production length [m]
1				11.0	110	2,000/E			
3	12.0	100	2,000/E	14.0	140	2,000/E	16.5	185	2,000/D
5	13.5	125	2,000/E	15.5	180	2,000/D	18.5	255	2,000/D
10	16.5	180	2,000/D	20.5	290	2,000/D	23.5	425	2,000/B
15	17.0	220	2,000/D	21.5	375	2,000/B	25.0	560	2,000/B
20	18.5	270	2,000/D	23.0	480	2,000/B	28.0	755	2,000/A
25	19.5	315	2,000/D	24.5	560	2,000/A	31.0	905	1,000/B
35	22.0	400	2,000/D	28.5	755	2,000/A	36.5	1,215	1,000/B
50	24.0	520	2,000/B	33.5	1,010	1,000/B	43.5	1,665	500/B
75	28.0	745	2,000/A	40.0	1,465	1,000/A	51.0	2,440	500/B
100	32.0	955	1,000/B	44.0	1,890	500/B	60.0	3,210	250/B
150	38.5	1,395	1,000/A	51.5	2,785	500/B	70.0	4,680	250/B
200	43.5	1,800	500/B	63.0	3,720	250/B	81.0	6,160	250/A
250	48.0	2,235	500/B	65.5	4,570	250/B			
300	51.5	2,620	500/B	73.0	5,410	250/B			
400	59.5	3,460	500/B	82.5	7,050	250/B			
500	65.0	4,235	250/B						
600	69.5	5,055	250/B						

Number of units	Design code TCEKFLEY			Design code TCEKFLEY			Design code TCEKFLEY		
	Wire/core diameter 0.4/0.8 mm			Wire/core diameter 0.6/1.2 mm			Wire/core diameter 0.8/1.6 mm		
	External diameter [mm]	Net weight [kg/km]	Standard production length [m]	External diameter [mm]	Net weight [kg/km]	Standard production length [m]	External diameter [mm]	Net weight [kg/km]	Standard production length [m]
1				20.0	240	2,000/D			
3	18.0	185	2,000/D	21.5	295	2,000/D	22.5	310	2,000/D
5	19.5	215	2,000/D	26.5	450	1,000/B	24.5	395	2,000/D
10	22.5	300	2,000/D	27.5	545	1,000/B	29.5	620	1,000/A
15	23.0	350	2,000/D	29.0	655	1,000/A	31.0	775	1,000/A
20	24.5	405	2,000/D	30.5	755	1,000/A	34.0	980	1,000/B
25	25.5	460	2,000/B	34.5	990	1,000/B	37.0	1,165	1,000/B
35	28.0	570	1,000/B	39.5	1,300	500/B	42.5	1,530	500/A
50	30.0	715	1,000/A	46.0	1,815	500/B	49.5	2,065	500/B
75	34.0	975	1,000/B	50.0	2,285	500/B	57.0	2,920	250/A
100	38.0	1,220	500/B	57.5	3,245	250/A	66.0	3,775	200/A
150	44.5	1,695	500/A	69.0	4,285	200/A	76.0	5,385	200/A
200	49.5	2,140	500/B	71.5	5,170	200/A	87.0	7,020	200/A
250	54.0	2,610	500/B	79.0	6,105	200/A			
300	57.5	3,040	250/A	88.5	7,890	200/A			
400	65.5	3,950	200/A						
500	71.0	4,790	200/A						
600	75.5	5,640	200/A						

Drum diameter (mm)

A 2,250 B 2,000 C 1,750 D 1,500 E 1,250 F 1,000

TCEKFLEZE, TCEKFLEZY

...x4x0.4 (0.6; 0.8)

Specification: TP 31.30.13 – KD – 001/94
TP 31.30.13 – KD – 002/94

Application

- » for basic phone services in analogue and digital transmission systems
- » designed to be placed under ground and to areas with higher demands for tensile strength
- » suspension without supporting rope and laying in areas jeopardised by effects of alternate electromagnetic fields
- » with PVC shield designed to be placed in areas with fire spread danger

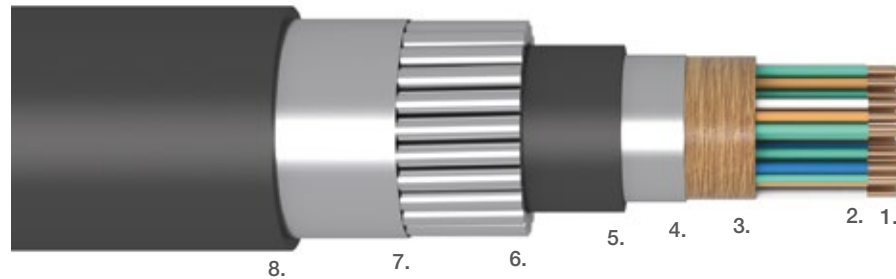

Description of materials:

1. Copper wire.
2. Core insulation – solid PE.
3. Crepe paper.
4. Laminated aluminium foil.
5. PE inner jacket, black.
6. Armor aluminium wires.
7. Fe/Zn tape.
8. PE or PVC outer jacket, black.

Transmission element – each 4 cores are twisted a star quad, the quads are stranded to units, the units are stranded to the cable core. Cable core is filled.

Environmental conditions

Temperature ranges for laying and assembly	-10 °C ÷ +60 °C
Operation and store temperatures	-40 °C ÷ +70 °C
Permitted minimum bending radius	min. 10D
Cable lifetime	min. 30 years

D – outside cable diameter

Electrical parameters (20 °C)

	mm	0.4	0.6	0.8
Conductor diameter	mm	0.4	0.6	0.8
Max. loop resistance	Ω/km	300	133.2	73.6
Insulation resistance min.	GΩ.km	10	10	10
Mutual capacitance	nF/km	49	49	49
Capacity unbalance k ₁ at 800 Hz	pF/500 m	800	800	500
Effective test voltage wire/wire at 50 Hz	V	1,000	1,000	1,000
Effective test voltage wire/shield at 50 Hz	V	2,000	2,000	2,000
Operating voltage max.	V _{ss}	250	250	250

Packing on drums.

Number of units	Design code TCEKFLEZE			Design code TCEKFLEZE			Design code TCEKFLEZE		
	Wire/core diameter 0.4/0.9 mm			Wire/core diameter 0.6/1.3 mm			Wire/core diameter 0.8/1.7 mm		
	External diameter [mm]	Net weight [kg/km]	Standard production length [m]	External diameter [mm]	Net weight [kg/km]	Standard production length [m]	External diameter [mm]	Net weight [kg/km]	Standard production length [m]
3	24.5	465	2,000/D	26.5	565	2,000/B	29.0	670	2,000/B
5	26.0	520	2,000/D	28.0	635	2,000/B	31.0	800	2,000/A
10	29.0	665	2,000/B	33.0	890	1,000/A	35.0	1,120	1,000/D
15	29.5	710	2,000/A	34.0	1,005	1,000/A	37.5	1,300	1,000/B
20	31.0	805	2,000/A	35.5	1,155	1,000/D	40.5	1,585	1,000/B
25	32.0	880	2,000/A	37.0	1,275	1,000/B	43.5	1,805	1,000/A
35	34.5	1,030	1,000/A	41.0	1,590	1,000/B	49.0	2,270	500/B
50	36.5	1,240	1,000/B	46.0	1,980	500/A	56.0	2,945	500/A
75	40.5	1,555	1,000/B	52.5	2,615	500/B	63.5	3,935	250/A
100	44.5	1,880	500/A	56.5	3,165	500/B			
150	51.0	2,475	500/B	64.0	4,280	250/A			
200	56.0	3,020	500/B						
250	60.5	3,570	500/B						
300	64.0	4,080	250/A						

	Design code TCEKFLEZY			Design code TCEKFLEZY			Design code TCEKFLEZY		
	Wire/core diameter 0.4/0.8 mm			Wire/core diameter 0.6/1.2 mm			Wire/core diameter 0.8/1.6 mm		
	External diameter [mm]	Net weight [kg/km]	Standard production length [m]	External diameter [mm]	Net weight [kg/km]	Standard production length [m]	External diameter [mm]	Net weight [kg/km]	Standard production length [m]
3	25.5	560	2,000/D	27.5	665	2,000/B	30.0	780	2,000/B
5	27.0	615	2,000/D	29.0	740	2,000/B	32.0	920	2,000/A
10	30.0	775	2,000/B	34.0	1,020	1,000/A	36.0	1,265	1,000/D
15	30.5	820	2,000/A	35.0	1,140	1,000/A	38.5	1,450	1,000/B
20	32.0	925	2,000/A	36.5	1,300	1,000/D	41.5	1,750	1,000/B
25	33.0	1,005	2,000/A	38.0	1,425	1,000/B	44.5	1,985	1,000/A
35	35.5	1,165	1,000/A	42.0	1,755	1,000/B	50.0	2,470	500/B
50	37.5	1,385	1,000/B	47.0	2,165	500/A	57.0	3,180	500/A
75	41.5	1,720	1,000/B	53.5	2,830	500/B	64.5	4,025	250/A
100	45.5	2,060	500/A	57.5	3,400	500/B			
150	52.0	2,685	500/B	65.0	4,555	250/A			
200	57.0	3,255	500/B						
250	61.5	3,825	500/B						
300	65.0	4,350	250/A						

Drum diameter (mm)

A 2,250	B 2,000	C 1,750	D 1,500	E 1,250	F 1,000
---------	---------	---------	---------	---------	---------

Armor is made from Al wires of nominal diameter 3.15 mm.
Nominal thickness of PVC sheath above armor is 2.5 mm.
Nominal thickness of PE sheath above armor is 2.0 mm.

TCEKFLES

...x4x0.4 (0.6; 0.8)

Specification: TP 31.30.13 - KD - 001/94
TP 31.30.13 - KD - 002/94

Application

- » basic phone services in analogue and digital transmission systems
- » designed to be suspended without special supporting rope

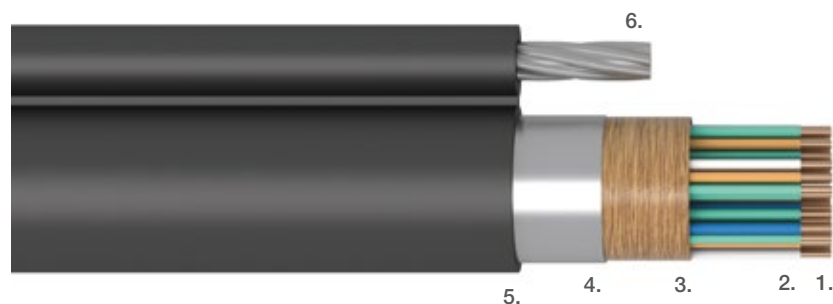

Description of materials:

1. Copper wire.
2. Core insulation – solid PE.
3. Crepe paper.
4. Laminated aluminium foil.
5. PE outer jacket, black.
6. Steel wire messenger.

Transmission element – star quad.

Environmental conditions

Temperature ranges for laying and assembly	-10 °C ÷ +60 °C
Operation and store temperatures	-40 °C ÷ +70 °C
Permitted minimum bending radius	min. 10D
Cable lifetime	min. 30 years

D – outside cable diameter

Electrical parameters (20 °C)

	mm	0.4	0.6	0.8
Conductor diameter	mm	0.4	0.6	0.8
Max. loop resistance	Ω/km	300	133.2	73.6
Insulation resistance min.	GΩ.km	10	10	10
Mutual capacitance	nF/km	49	49	49
Capacity unbalance k _i at 800 Hz	pF/500 m	800	800	500
Effective test voltage wire/wire at 50 Hz	V	350	350	350
Effective test voltage wire/shield at 50 Hz	V	700	700	700
Operating voltage max.	V _{ss}	250	250	250

Packing on drums.

Number of units	Wire/core diameter 0.4/0.9 mm			Wire/core diameter 0.6/1.3 mm			Wire/core diameter 0.8/1.7 mm		
	External diameter [mm]	Net weight [kg/km]	Standard production length [m]	External diameter [mm]	Net weight [kg/km]	Standard production length [m]	External diameter [mm]	Net weight [kg/km]	Standard production length [m]
1	12.0	280	2,000/D	14.0	320	2,000/D	16.0	370	2,000/A
3	13.0	220	2,000/D	15.0	280	2,000/B	18.0	360	2,000/A
5	16.0	360	2,000/A	20.0	480	2,000/A	23.0	620	1,000/B
10	17.0	405	2,000/A	21.0	565	1,000/B	24.5	770	1,000/B
15	18.0	450	1,000/D	23.0	660	1,000/B	28.0	945	1,000/A
20	19.0	495	1,000/D	24.5	750	1,000/B	31.0	1,105	500/B
25	21.5	585	1,000/B	28.5	950	1,000/A	36.5	1,435	500/B
35	24.0	710	1,000/B	33.5	1,225	500/B			
50	28.0	935	1,000/A	40.0	1,690	500/B			
75	32.0	1,150	500/B						
100									

Drum diameter (mm)

A 2,250 B 2,000 C 1,750 D 1,500 E 1,250 F 1,000

Nominal tensile strength of supporting element for cables up to 3 units is 7 000 N, for other cables 16 000 N.

TCEKFLH

...x4x0.4 (0.6; 0.8)

Specification: TP 31.30.13 - KD - 001/94
TP 31.30.13 - KD - 002/94

Application

- » basic phone services in analogue and digital transmission systems
- » to be placed in cable ducts, under ground laying and areas without higher danger of mechanical cable damage
- » designed especially for using in areas danger of fire

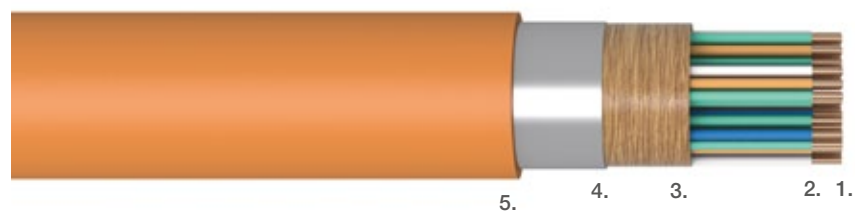

Description of materials:

1. Copper wire.
2. Core insulation – solid PE.
3. Crepe paper.
4. Laminated aluminium foil.
5. FRNC outer jacket, orange.

Transmission element – each 4 cores are twisted a star quad, the quads are stranded to units, the units are stranded to the cable core.

Environmental conditions

Temperature ranges for laying and assembly	-10 °C ÷ +60 °C
Operation and store temperatures	-40 °C ÷ +70 °C
Permitted minimum bending radius	min. 10D
Cable lifetime	min. 30 years

D – outside cable diameter

Electrical parameters (20 °C)

	mm	0.4	0.6	0.8
Conductor diameter	mm	0.4	0.6	0.8
Max. loop resistance	Ω/km	300	133.2	73.6
Insulation resistance min.	GΩ.km	10	10	10
Mutual capacitance	nF/km	49	49	49
Capacity unbalance k ₁ at 800 Hz	pF/500 m	800	800	500
Effective test voltage wire/wire at 50 Hz	V	1,000	1,000	1,000
Effective test voltage wire/shield at 50 Hz	V	2,000	2,000	2,000
Operating voltage max.	V _{ss}	250	250	250

Packing on drums.

Number of units	Wire/core diameter 0.4/0.9 mm			Wire/core diameter 0.6/1.3 mm			Wire/core diameter 0.8/1.7 mm		
	External diameter [mm]	Net weight [kg/km]	Standard production length [m]	External diameter [mm]	Net weight [kg/km]	Standard production length [m]	External diameter [mm]	Net weight [kg/km]	Standard production length [m]
3	12.5	140	2,000/E	14.5	170	2,000/E	16.5	230	2,000/D
5	13.5	160	2,000/E	16.0	210	2,000/D	18.5	300	2,000/D
10	16.5	230	2,000/D	20.5	340	2,000/B	24.0	470	2,000/B
15	17.5	260	2,000/D	21.5	400	2,000/B	25.0	580	2,000/A
20	18.5	305	2,000/D	23.5	480	2,000/B	28.0	740	1,000/C
25	19.5	340	2,000/C	25.0	550	2,000/A	31.0	850	1,000/A
35	22.0	420	2,000/B	28.5	710	1,000/C	35.0	1,100	1,000/A
50	24.5	530	2,000/B	32.5	920	1,000/B	45.0	1,660	750/A
75	28.0	695	1,000/C	41.5	1,450	750/A	52.0	2,270	500/A
100	32.0	905	1,000/B	45.5	1,820	750/A	61.5	2,930	333/A
150	40.0	1,380	750/A	53.0	2,500	500/A			
200	45.0	1,720	750/A	63.5	3,250	333/A			
250	49.0	2,035	500/A	66.0	3,820	333/A			
300	53.0	2,335	500/A						
400	60.0	2,960	333/A						
500	65.5	3,535	333/A						
600	70.0	4,070	333/A						

Drum diameter (mm)

A 2,250	B 2,000	C 1,750	D 1,500	E 1,250	F 1,000
---------	---------	---------	---------	---------	---------

TCEKFLHZH

...x4x0.4 (0.6; 0.8)

Specification: TP 31.30.13 - KD - 001/94
TP 31.30.13 - KD - 002/94

Application

- » for basic phone services in analogue and digital transmission systems
- » designed to be placed under ground and to areas with higher demands for tensile strength
- » suspension without supporting rope and laying in areas jeopardised by effects of alternate electromagnetic fields
- » designed especially for using in areas danger of fire

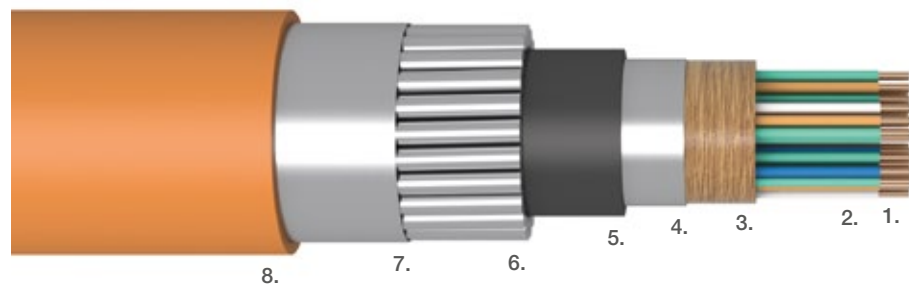

Description of materials:

1. Copper wire.
2. Core insulation – solid PE.
3. Crepe paper.
4. Laminated aluminium foil.
5. PE inner jacket, black.
6. Armor aluminium wires.
7. Fe/Zn tape.
8. FRNC outer jacket, orange.

Transmission element – each 4 cores are twisted a star quad, the quads are stranded to units, the units are stranded to the cable core.

Environmental conditions

Temperature ranges for laying and assembly	-10 °C ÷ +60 °C
Operation and store temperatures	-40 °C ÷ +70 °C
Permitted minimum bending radius	min. 10D
Cable lifetime	min. 30 years

D – outside cable diameter

Electrical parameters (20 °C)

	mm	0.4	0.6	0.8
Conductor diameter	mm	0.4	0.6	0.8
Max. loop resistance	Ω/km	300	133.2	73.6
Insulation resistance min.	GΩ.km	10	10	10
Mutual capacitance	nF/km	49	49	49
Capacity unbalance k_1 at 800 Hz	pF/500 m	800	800	500
Effective test voltage wire/wire at 50 Hz	V	1,000	1,000	1,000
Effective test voltage wire/shield at 50 Hz	V	2,000	2,000	2,000
Operating voltage max.	V _{ss}	250	250	250

Packing on drums.

Number of units	Wire/core diameter 0.4/0.9 mm			Wire/core diameter 0.6/1.3 mm			Wire/core diameter 0.8/1.7 mm		
	External diameter [mm]	Net weight [kg/km]	Standard production length [m]	External diameter [mm]	Net weight [kg/km]	Standard production length [m]	External diameter [mm]	Net weight [kg/km]	Standard production length [m]
3	21.9	590	2,000/B	23.9	700	2,000/B	25.7	810	1,000/D
5	22.7	640	2,000/B	24.9	770	1,000/D	27.7	940	1,000/C
10	25.8	810	2,000/A	29.8	1,050	1,000/B	33.0	1,270	1,000/B
15	26.4	840	2,000/A	30.7	1,150	1,000/B	34.2	1,410	1,000/B
20	27.7	960	1,000/C	32.6	1,260	1,000/B	37.2	1,670	1,000/A
25	28.8	1,010	1,000/B	33.9	1,390	1,000/B	39.9	1,870	1,000/A
35	31.2	1,160	1,000/B	37.4	1,640	1,000/A	43.9	2,230	750/A
50	33.6	1,340	1,000/B	41.7	2,000	750/A	53.4	2,850	500/A
75	37.1	1,630	1,000/A	49.9	2,540	500/A	60.8	3,640	333/A
100	40.9	1,900	750/A	53.9	2,950	500/A	70.0	4,450	333/A
150	48.6	2,400	500/A	61.4	3,850	333/A			
200	53.4	2,850	500/A						
250	57.7	3,270	333/A						
300	61.4	3,700	333/A						
400	68.4	4,500	333/A						

Drum diameter (mm)

A 2,250	B 2,000	C 1,750	D 1,500	E 1,250	F 1,000
---------	---------	---------	---------	---------	---------

A armor is made from Al wires of nominal diameter 3.15 mm. Nominal thickness of FRNC sheath above armor is 2.0 mm.

TCEPKPFLE, TCEPKPFLEY

...x4x0.4 (0.6; 0.8)

Specification: TP 31.30.13 - KD - 001/94, TP 31.30.13 - KD - 002/94

Application

- » for basic phone services in analogue and digital transmission systems
- » to be placed in cable ducts, under ground laying and areas without higher danger of mechanical cable damage
- » the cables with PVC shield are designed to be placed in areas with fire spread danger

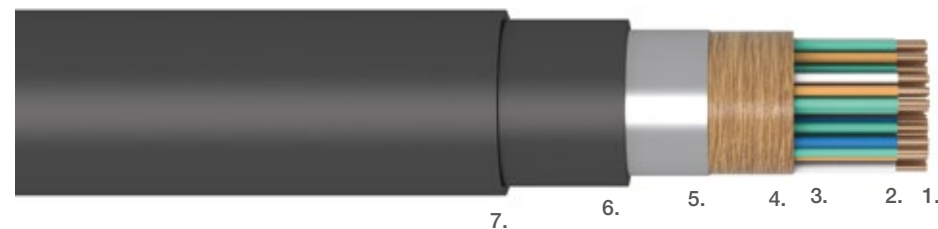

Description of materials:

1. Copper wire.
2. Core insulation – foam skin PE.
3. Filling material.
4. Crepe paper.
5. Laminated aluminium foil.
6. PE inner jacket.
7. PVC outer jacket, black.

Transmission element – each 4 cores are twisted a star quad, the quads are stranded to units, the units are stranded to the cable core. Cable core filled.

Environmental conditions

Temperature ranges for laying and assembly	-10 °C ÷ +60 °C
Operation and store temperatures	-40 °C ÷ +70 °C
Permitted minimum bending radius	min. 10D
Cable lifetime	min. 30 years

D – outside cable diameter

Electrical parameters (20 °C)

Conductor diameter	mm	0.4	0.6	0.8
Max. loop resistance	Ω/km	300	133.2	73.6
Insulation resistance	GΩ.km	min. 10	min. 10	min. 10
Mutual capacitance	nF/km	max. 49	max. 49	max. 49
Capacity unbalance k1 at 800 Hz	pF/500 m	800	800	500
Effective test voltage wire/wire at 50 Hz	V	350	350	350
Effective test voltage wire/shield at 50 Hz	V	700	700	700
Operating voltage	V _{ss}	250	250	250

Packing on drums.

Number of units	Wire/core diameter 0.4/0.8 mm			Wire/core diameter 0.6/1.2 mm			Wire/core diameter 0.8/1.6 mm		
	External diameter [mm]	Net weight [kg/km]	Standard production length [m]	External diameter [mm]	Net weight [kg/km]	Standard production length [m]	External diameter [mm]	Net weight [kg/km]	Standard production length [m]
TCEPKPFLE									
1	10.5	55	2,000/F	11.0	80	2,000/F	11.5	120	2,000/E
3	12.5	75	2,000/F	14.5	130	2,000/E	15.0	160	2,000/E
5	13.0	100	2,000/F	15.5	165	2,000/E	18.5	265	2,000/D
10	15.0	150	2,000/E	18.0	260	2,000/D	21.0	410	2,000/D
15	17.0	205	2,000/E	21.5	370	2,000/D	24.5	590	1,000/B
20	18.0	250	2,000/D	23.5	470	2,000/D	28.5	775	2,000/A
25	20.0	295	2,000/D	24.5	555	2,000/D	31.5	975	2,000/A
35	21.5	380	2,000/D	29.0	765	2,000/A	36.0	1,310	1,000/B
50	24.5	525	2,000/D	33.0	1,055	1,000/D	41.0	1,795	1,000/A
75	28.0	720	2,000/B	37.5	1,495	1,000/B	48.0	2,630	500/A
100	31.0	940	2,000/A	42.0	1,970	1,000/A	55.5	3,495	500/A
150	36.0	1,355	2,000/B	48.5	2,835	500/B	66.0	5,185	250/B
200	39.0	1,735	2,000/A	56.5	3,800	500/A			
250	42.5	2,145	500/B	63.5	4,795	250/B			
300	47.5	2,660	500/B	66.5	5,570	250/B			
400	56.0	3,605	500/A						
500	60.5	4,375	250/B						
600	65.5	5,235	250/B						
800	76.0	6,805	250/A						
TCEPKPFLEY									
Thickness of PVC sheath is 2.0 mm									
1	16.5	125	2,000/E	17.0	150	2,000/E	17.5	175	2,000/E
3	18.5	180	2,000/E	20.5	240	2,000/D	21.0	275	2,000/D
5	19.0	200	2,000/D	21.5	290	2,000/D	24.5	410	2,000/D
10	21.0	265	2,000/D	24.0	400	2,000/D	27.0	580	1,000/B
15	23.0	340	2,000/D	27.5	535	2,000/B	30.5	790	1,000/A
20	24.0	395	2,000/D	29.5	650	1,000/B	34.5	1,000	1,000/D
25	26.0	445	2,000/B	30.5	745	1,000/A	37.5	1,220	1,000/B
35	27.5	540	2,000/B	35.0	985	1,000/D	42.0	1,585	500/A
50	30.5	715	1,000/A	39.0	1,310	1,000/B	47.0	2,115	500/B
75	34.0	925	1,000/A	43.5	1,785	500/A	54.0	3,010	500/B
100	37.0	1,180	1,000/B	48.0	2,295	500/B	61.5	3,930	250/A
150	42.0	1,630	500/B	54.5	3,220	500/B	72.0	5,705	200/A
200	45.0	2,035	500/A	62.5	4,245	250/A			
250	48.5	2,480	500/B						
300	53.5	3,035	500/B						
400	62.0	4,045	250/A						
500	66.5	4,850	250/B						
600	71.5	5,750	250/A						
800	82.0	7,385	250/A						



2. SIGNAL CABLES

A-HH

A-H(L)H

A-HHBH

AJ-HHAH

A-2Y2YV

A-2Y(L)2YV

A-2Y2YB2Y

A-2Y(L)2YB2Y

AJ-2Y2YDB2Y

AJ-2Y(L)2YDB2Y

A-HH

...x2x... P LG FRNC (...x2x... PIMF LG FRNC)

Specification: TP 31.30.13 – KDP – 01/00, ČSN IEC 332-3A, ČSN EN 50268-2, ČSN EN 50267-2-2

Application

- » transmission of electric signal of telecommunication, controlling and protecting purposes or control circuits
- » designed especially for using in area danger of fire
- » for indoor installations, tunnels or collectors, laying at cable ducts, on cable bridges, on cable grids or supports, burial in sand bedding, grasp or free placing in standard
- » wet or moist ambient, spraying water and fleet immersion, dropping water with pH 7÷11

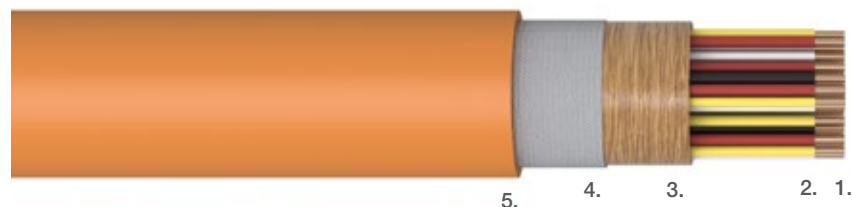

Description of materials:

1. Copper wire.
2. Core insulation – solid PE.
3. Crepe paper.
4. Flame retardant tape.
5. FRNC outer jacket, orange.

Each 2 wires twisted to a pair (screened or unscreened).

A-HH ... P A-HH-J ... P			
Number of units	External diameter [mm]	Net weight [kg/km]	Standard production length [m]
Core diameter 1.0 mm			
1	11.2	107	2,000
2	13.2	145	2,000
3	15.0	181	2,000
4	15.4	205	2,000
6	15.9	249	2,000
7	16.6	275	2,000
12	20.0	404	2,000
16	22.3	504	2,000
24	27.4	708	1,000
30	29.7	843	1,000
48	34.3	1,398	1,000
61	38.7	1,715	500
Core diameter 1.12 mm			
1	11.2	110	2,000
2	13.2	151	2,000
3	15.0	191	2,000
4	15.4	217	2,000
6	15.9	268	2,000
7	16.6	297	2,000
12	20.0	443	2,000
16	22.3	555	2,000
24	27.4	785	1,000
30	29.7	939	1,000
48	34.3	1,552	1,000
61	38.7	1,910	500

A-HH ... PIMF A-HH-J ... PIMF			
Number of units	External diameter [mm]	Net weight [kg/km]	Standard production length [m]
Core diameter 1.0 mm			
1	11.9	113	2,000
2	14.1	153	2,000
3	16.0	191	2,000
4	16.4	214	2,000
6	17.5	263	2,000
7	18.4	291	2,000
12	22.7	429	2,000
16	25.5	534	2,000
24	31.8	749	1,000
30	33.9	886	1,000
48	41.6	1,479	500
61	46.9	1,808	500
Core diameter 1.12 mm			
1	11.9	117	2,000
2	14.1	160	2,000
3	16.0	200	2,000
4	16.4	227	2,000
6	17.5	283	2,000
7	18.4	314	2,000
12	22.7	468	2,000
16	25.5	585	2,000
24	31.8	826	1,000
30	33.9	982	1,000
48	41.6	1,632	1,000
61	46.9	2,003	500

Environmental conditions

Temperature ranges for laying and assembly	-5 °C
Operation and store temperatures	-40 °C ÷ +65 °C
Permitted minimum bending radius	min. 10D
Cable lifetime	min. 40 years

D – outside cable diameter

Packing on drums.

A-H(L)H

...x2x... P LG FRNC (...x2x... PIMF LG FRNC)

Specification: TP 31.30.13 – KDP – 01/00, ČSN IEC 332-3A, ČSN EN 50268-2, ČSN EN 50267-2-2

Application

- » transmission of electric signal of telecommunication, controlling and protecting purposes or control circuits
- » designed especially for using in area danger of fire
- » for indoor installations, tunnels or collectors, laying at cable ducts, on cable bridges, on cable grids or supports, burial in sand bedding, grasp or free placing in standard
- » wet or moist ambient, spraying water and fleet immersion, dropping water with pH 7÷11

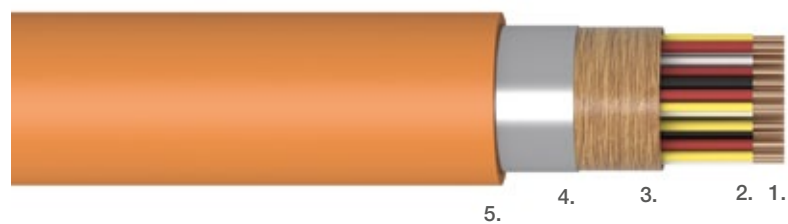

Description of materials:

1. Copper wire.
2. Core insulation – solid PE.
3. Crepe paper.
4. Laminated aluminium foil.
5. FRNC outer jacket, orange.

Each 2 wires twisted to a pair (screened or unscreened).

A-H(L)H ... P A-H(L)H-J ... P			
Number of units	External diameter [mm]	Net weight [kg/km]	Standard production length [m]
Core diameter 1.0 mm			
1	11.6	124	2,000
2	13.6	165	2,000
3	15.4	205	2,000
4	15.8	230	2,000
6	16.3	273	2,000
7	17.0	302	2,000
12	20.4	437	2,000
16	22.7	541	2,000
24	27.8	754	1,000
30	30.1	889	1,000
48	34.7	1,454	1,000
61	39.1	1,778	500
Core diameter 1.12 mm			
1	11.6	127	2,000
2	13.6	171	2,000
3	15.4	215	2,000
4	15.8	241	2,000
6	16.3	293	2,000
7	17.0	324	2,000
12	20.4	475	2,000
16	22.7	592	2,000
24	27.8	831	1,000
30	30.1	985	1,000
48	34.7	1,607	1,000
61	39.1	1,974	500

A-H(L)H ... PIMF A-H(L)H-J ... PIMF			
Number of units	External diameter [mm]	Net weight [kg/km]	Standard production length [m]
Core diameter 1.0 mm			
1	12.3	131	2,000
2	14.5	173	2,000
3	16.4	214	2,000
4	16.8	239	2,000
6	17.9	289	2,000
7	18.8	318	2,000
12	23.1	465	2,000
16	25.9	574	2,000
24	32.2	802	1,000
30	34.3	944	1,000
48	42.0	1,545	500
61	47.3	1,883	500
Core diameter 1.12 mm			
1	12.3	134	2,000
2	14.5	179	2,000
3	16.4	224	2,000
4	16.8	252	2,000
6	17.9	309	2,000
7	18.8	341	2,000
12	23.1	503	2,000
16	25.9	625	2,000
24	32.2	879	1,000
30	34.3	1,040	1,000
48	42.0	1,698	1,000
61	47.3	2,078	500

Environmental conditions

Temperature ranges for laying and assembly	-5 °C
Operation and store temperatures	-40 °C ÷ +65 °C
Permitted minimum bending radius	min. 10D
Cable lifetime	min. 40 years

D – outside cable diameter

Packing on drums.

A-HHBH

...x2x... P LG (R...VZK) FRNC (...x2x... PIMF LG (R...VZK) FRNC)

Specification: TP 31.30.13 – KDP – 01/00, ČSN IEC 332-3A, ČSN EN 50268-2, ČSN EN 50267-2-2

Application

- » transmission of electric signal of telecommunication, controlling and protecting purposes of control circuit
- » for using in area danger of fire
- » for indoor and outdoor installations, tunnels or collectors, direct burial placing with highest tension or supporting without carrying wire
- » grasp or free placing in areas with alternating electromagnetic field danger
- » standard, wet or moist ambient, spraying water and fleet immersion, dropping water with pH 7÷11

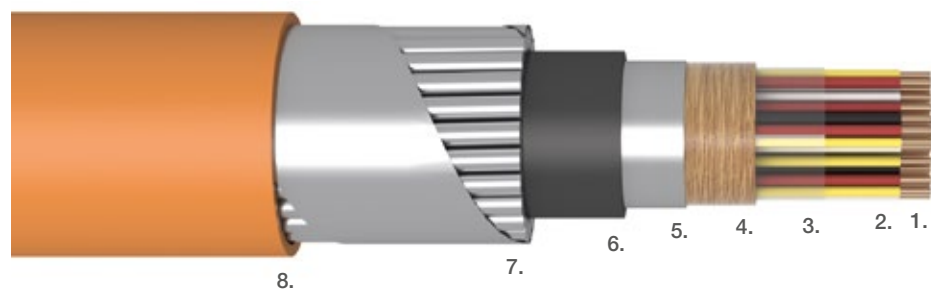

Description of materials:

1. Copper wire.
2. Core insulation – solid PE.
3. Wrapping plastic tape.
4. Crepe paper.
5. Laminated aluminium foil.
6. PE inner jacket, black.
7. Fe/Zn wires.
8. FRNC outer jacket, orange.

Each 2 wires twisted to a pair (Screened or unscreened).

Environmental conditions

Temperature ranges for laying and assembly	-5 °C
Operation and store temperatures	-40 °C ÷ +65 °C
Permitted minimum bending radius	min. 10D
Cable lifetime	min. 40 years

D – outside cable diameter

Packing on drums.

A-HHBH ... P A-HHBH-J ... P			
Number of units	External diameter [mm]	Net weight [kg/km]	Standard production length [m]
Core diameter 1.0 mm			
3	23.9	1,010	1,000
4	24.3	1,040	1,000
6	24.8	1,130	1,000
7	25.5	1,200	1,000
12	28.9	1,520	1,000
16	31.2	1,760	1,000
24	36.8	2,245	1,000
30	28.6	2,480	1,000
48	43.2	3,280	500
61	47.6	3,880	500
Core diameter 1.12 mm			
3	23.9	1,020	2,000
4	24.3	1,050	2,000
6	24.8	1,150	2,000
7	25.5	1,220	2,000
12	28.9	1,555	2,000
16	31.2	1,810	2,000
24	36.8	2,320	1,000
30	28.6	2,570	1,000
48	43.2	3,430	1,000
61	47.6	4,060	500

A-HHBH ... PIMF A-HHBH-J ... PIMF			
Number of units	External diameter [mm]	Net weight [kg/km]	Standard production length [m]
Core diameter 1.0 mm			
3	24.4	1,120	1,000
4	24.6	1,150	1,000
6	25.7	1,255	1,000
7	26.6	1,330	1,000
12	30.9	1,725	1,000
16	34.1	2,035	1,000
24	40.4	2,610	500
30	42.5	2,910	500
48	50.2	3,940	500
61	55.5	4,610	500
Core diameter 1.12 mm			
3	24.4	1,130	1,000
4	24.6	1,160	1,000
6	25.7	1,275	1,000
7	26.6	1,355	1,000
12	30.9	1,760	1,000
16	34.1	2,080	1,000
24	40.4	2,680	500
30	42.5	3,000	500
48	50.2	4,085	500
61	55.5	4,795	500

AJ-HHAH

...x2x... P LG (...AL) FRNC (...x2x... PIMF LG (...AL) FRNC)

Specification: TP 31.30.13 – KDP – 01/00, ČSN IEC 332-3A, ČSN EN 50268-2, ČSN EN 50267-2-2

Application

- » transmission of electric signal of telecommunication, controlling and protecting purposes of control circuit
- » for using in area danger of fire
- » for indoor and outdoor installations, tunnels or collectors, direct burial placing with highest tension or supporting without carrying wire
- » grasp or free placing in areas with alternating electromagnetic field danger
- » standard, wet or moist ambient, spraying water and fleet immersion, dropping water with pH 7÷11

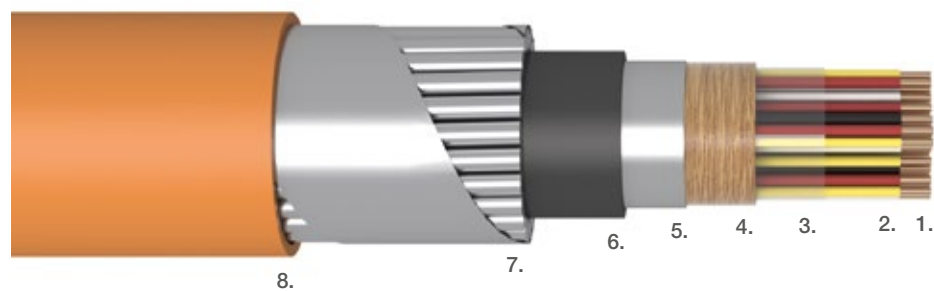

Description of materials:

1. Copper wire.
2. Core insulation – solid PE.
3. Wrapping plastic tape.
4. Crepe paper.
5. Laminated aluminium foil.
6. PE inner jacket, black.
7. Armor aluminium wires.
8. FRNC outer jacket, orange.

Each 2 wires twisted to a pair (Screened or unscreened).

Environmental conditions

Temperature ranges for laying and assembly	-5 °C
Operation and store temperatures	-40 °C ÷ +65 °C
Permitted minimum bending radius	min. 10D
Cable lifetime	min. 40 years

D – outside cable diameter

Packing on drums.

A-HHAH ... P A-HHAH-J ... P			
Number of units	External diameter [mm]	Net weight [kg/km]	Standard production length [m]
Core diameter 1.0 mm			
3	24.8	635	1,000
4	25.2	661	1,000
6	25.7	729	1,000
7	26.4	759	1,000
12	29.8	993	1,000
16	32.6	1,148	1,000
24	37.7	1,487	500
30	39.5	1,653	500
48	44.1	2,381	500
61	48.5	2,807	500
Core diameter 1.12 mm			
3	24.8	645	1,000
4	25.2	674	1,000
6	25.7	748	1,000
7	26.4	781	1,000
12	29.8	1,031	1,000
16	32.6	1,200	1,000
24	37.7	1,564	500
30	39.5	1,749	500
48	44.1	2,534	500
61	48.5	3,002	500

A-HHAH ... PIMF A-HHAH-J ... PIMF			
Number of units	External diameter [mm]	Net weight [kg/km]	Standard production length [m]
Core diameter 1.0 mm			
3	25.5	674	1,000
4	25.9	700	1,000
6	27.0	775	1,000
7	27.9	831	1,000
12	32.2	1,079	1,000
16	35.0	1,262	1,000
24	41.3	1,641	500
30	43.4	1,832	500
48	51.1	2,604	500
61	56.4	3,090	500
Core diameter 1.12 mm			
3	25.5	684	1,000
4	25.9	713	1,000
6	27.0	796	1,000
7	27.9	854	1,000
12	32.2	1,117	1,000
16	35.0	1,314	1,000
24	41.3	1,718	500
30	43.4	1,928	500
48	51.1	2,758	500
61	56.4	3,285	500

A-2Y2YV

... x1x0.9 (1.4; 1.8) S LG (H95; H115; H145)

Specification: Dlk. 1.013.107y, Dlk. 1.013.108y, Dlk. 1.013.110y

Application

- » for general use in protective devices
- » for use as underground and conduit cables

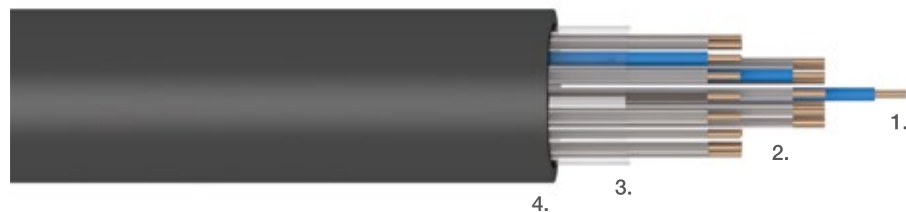

Description of materials:

1. Copper wire. 2. Core insulation – solid PE. 3. Plastic tape. 4. PE outer jacket, black.

Cable is wires stranded in concentric layers.

Environmental conditions

Temperature ranges for laying and assembly	-10 °C ÷ +60 °C
Operation and store temperatures	-40 °C ÷ +70 °C
Permitted minimum bending radius	min. 10D
Cable lifetime	min. 30 years

D – outside cable diameter

Electrical parameters (20 °C)

	mm	0.9	1.4	1.8
Conductor diameter	mm	0.9	1.4	1.8
Max. loop resistance	Ω/km	28.9	11.9	7.2
Insulation resistance	GΩ.km	10	10	10
Effective test voltage wire/wire at 50 Hz	V	2,500	2,500	2,500
Effective test voltage wire/shield at 50 Hz	V	2,500	2,500	2,500
Operating voltage	V _{ss}	600	600	600

Packing on drums.

Number of units	Wire/core diameter H95 0.9/1.55 mm			Wire/core diameter H115 1.4/2.2 mm			Wire/core diameter H145 1.8/2.7 mm		
	External diameter [mm]	Net weight [kg/km]	Standard production length [m]	External diameter [mm]	Net weight [kg/km]	Standard production length [m]	External diameter [mm]	Net weight [kg/km]	Standard production length [m]
	H115			H145					
2	8.0	50	1,000						
4	9.0	70	1,000	11.0	120	1,000	12.0	170	1,000
7	10.0	100	1,000	12.0	170	1,000	14.0	260	1,000
10	11.0	130	1,000	14.0	240	1,000	16.0	370	1,000
14	12.0	160	1,000	15.0	320	1,000	18.0	490	1,000
20	13.0	210	1,000	17.0	430	1,000	21.0	670	1,000
24	14.0	250	1,000	18.0	500	1,000	22.0	790	1,000
30	15.0	300	1,000	20.0	610	1,000	24.0	960	1,000
40	16.0	380	1,000	21.0	790	1,000	27.0	1,260	1,000
50	18.0	460	1,000	24.0	970	1,000	29.0	1,540	1,000
60	19.0	530	1,000	25.0	1,150	1,000	31.0	1,830	1,000
80	21.0	680	1,000	28.0	1,490	1,000	35.0	2,420	1,000
100	23.0	850	1,000	32.0	1,870	1,000	40.0	3,000	1,000
120	25.0	990	1,000	34.0	2,220	1,000	42.0	3,570	500
140	26.0	1,150	1,000	37.0	2,560	1,000	45.0	4,130	500
160	28.0	1,300	1,000	39.0	2,910	1,000	49.0	4,730	500
180	29.0	1,460	1,000	41.0	3,260	1,000	52.0	5,310	500
200	30.0	1,600	1,000	42.0	3,590	500	53.0	5,870	500

Number of units	Wire/core diameter H95 1.4/2.7 mm			Wire/core diameter H95 1.8/3.4 mm		
	External diameter [mm]	Net weight [kg/km]	Standard production length [m]	External diameter [mm]	Net weight [kg/km]	Standard production length [m]
	H95					
10	16.0	280	1,000	19.0	410	1,000
14	18.0	370	1,000	21.0	560	1,000
20	20.0	500	1,000	24.0	760	1,000
30	24.0	700	1,000	28.0	1,090	1,000
50	29.0	1,120	1,000	36.0	1,770	1,000

A-2Y(L)2YV

... x4x0.9 S LG (H45)

Specification: Dlk. 1.013.109y, Dlk.1.013.110y

Application

- » cables are designed for general use in protective equipment
- » cables are suitable for placement as in earth or conduits

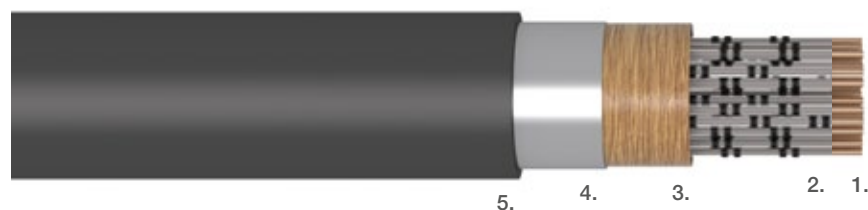

Description of materials:

1. Copper wire.
2. Core insulation – solid PE.
3. Crepe paper.
4. Laminated aluminium foil.
5. PE outer jacket, black.

Cable is quads stranded in concentric layers.

Environmental conditions

Temperature ranges for laying and assembly	-10 °C ÷ +60 °C
Operation and store temperatures	-25 °C ÷ +60 °C
Permitted minimum bending radius	min. 15D
Cable lifetime	min. 30 years

D – outside cable diameter

Electrical parameters (20 °C)

Conductor diameter	mm	0.9
Max. loop resistance	Ω/km	56.6
Insulation resistance	GΩ.km	10
Mutual capacitance	nF/km	45
Effective test voltage wire/wire at 50 Hz	V	2,500
Effective test voltage wire/shield at 50 Hz	V	2,500
Operating voltage	V _{ss}	600

Packing on drums.

Wire/core diameter H45 0.9/1.8 mm			
Number of units	External diameter [mm]	Net weight [kg/km]	Standard production length [m]
1	10.0	100	1,000
3	15.0	190	1,000
5	17.0	290	1,000
7	19.0	360	1,000
10	22.0	490	1,000
14	25.0	640	1,000
20	28.0	860	1,000
30	34.0	1,240	1,000
40	38.0	1,610	1,000

A-2Y2YB2Y

... x1x0.9 (1.4; 1.8) S LG...B 0 (H95; H115 resp. H145)

Specification: Dlk. 1.013.107y, Dlk. 1.013.108y, Dlk. 1.013.110y

Application

- » for general use in protective devices
- » for use as underground and conduit cables

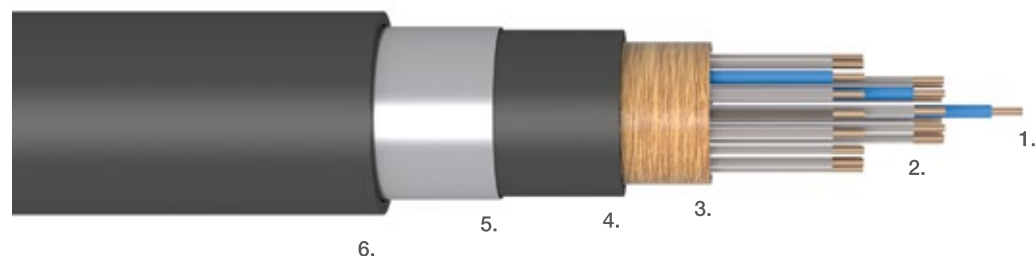

Description of materials:

1. Copper wire.
2. Core insulation – foam skin PE.
3. Crepe paper.
4. PE inner jacket, black.
5. Steel armour tape.
6. PE outer jacket, black.

Cable core – conductors stranded in concentric layers.

Environmental conditions

Temperature ranges for laying and assembly	-10 °C ÷ +60 °C
Operation and store temperatures	-40 °C ÷ +70 °C
Permitted minimum bending radius	min. 10D
Cable lifetime	min. 30 years

D – outside cable diameter

Electrical parameters (20 °C)

Parameter	Unit	0.9	1.4	1.8
Conductor diameter	mm	0.9	1.4	1.8
Max. loop resistance	Ω/km	28.9	11.9	7.2
Insulation resistance	GΩ.km	10	10	10
Effective test voltage wire/wire at 50 Hz	V	2,500	2,500	2,500
Effective test voltage wire/shield at 50 Hz	V	2,500	2,500	2,500
Operating voltage	V _{ss}	600	600	600

Packing on drums.

Number of units	Wire/core diameter H95 0.9/1.55 mm			Wire/core diameter H115 1.4/2.2 mm			Wire/core diameter H145 1.8/2.7 mm		
	External diameter [mm]	Net weight [kg/km]	Standard production length [m]	External diameter [mm]	Net weight [kg/km]	Standard production length [m]	External diameter [mm]	Net weight [kg/km]	Standard production length [m]
	H115			H145					
2	10.0	110	1,000	13.0	180	1,000			
4	11.0	130	1,000	14.0	250	1,000	14.0	250	1,000
7	12.0	150	1,000	16.0	330	1,000	16.0	360	1,000
10	13.0	190	1,000	17.0	410	1,000	18.0	470	1,000
14	14.0	240	1,000	19.0	540	1,000	20.0	630	1,000
20	15.0	300	1,000	21.0	650	1,000	23.8	840	1,000
24	16.0	350	1,000	22.0	760	1,000	24.0	960	1,000
30	17.0	400	1,000	24.0	950	1,000	26.0	1,150	1,000
40	18.0	480	1,000	26.0	1,160	1,000	29.0	1,470	1,000
50	20.0	600	1,000	27.0	1,340	1,000			
60	21.0	680	1,000						
80	23.0	850	1,000						
100	26.0	1,030	1,000						
120	27.0	1,190	1,000						
140	29.0	1,360	1,000						

Number of units	Wire/core diameter H115 1.4/2.7 mm			Wire/core diameter H145 1.8/3.4 mm		
	External diameter [mm]	Net weight [kg/km]	Standard production length [m]	External diameter [mm]	Net weight [kg/km]	Standard production length [m]
10	18.0	390	1,000	21.0	570	1,000
14	20.0	500	1,000	23.0	720	1,000
20	22.0	660	1,000			

Note: Cable versions according to Dlk 1.013.102 on request

A-2Y(L)2YB2Y

...x4x0.9 S LG (...B 0...) (H45)

Specification: Dlk. 1.013.109y, Dlk.1.013.110y

Application

- » cables are designed for general use in protective equipment
- » cables are suitable for placement as in earth or conduits

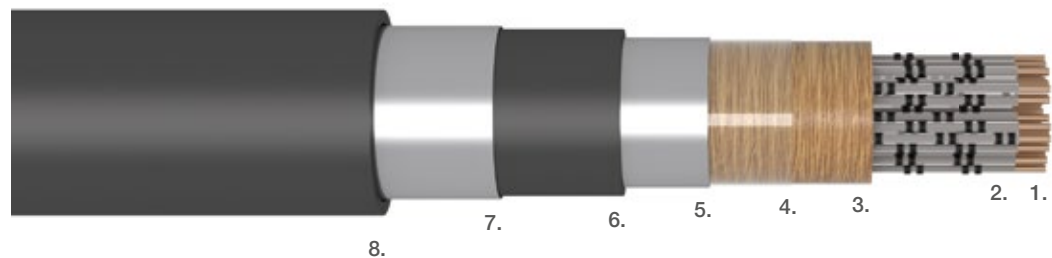

Description of materials:

1. Copper wire.
2. Core insulation – solid PE.
3. Crepe paper.
4. Plastic tape.
5. Laminated aluminium foil.
6. PE inner jacket, black.
7. Stell armour tape.
8. PE outer jacket, black.

Cable core – quads stranded in concentric layers.

Environmental conditions

Temperature ranges for laying and assembly	-10 °C ÷ +60 °C
Operation and store temperatures	-25 °C ÷ +60 °C
Permitted minimum bending radius	min. 15D
Cable lifetime	min. 30 years

D – outside cable diameter

Electrical parameters (20 °C)

Conductor diameter	mm	0.9
Max. loop resistance	Ω/km	56.6
Insulation resistance	GΩ.km	10
Mutual capacitance	nF/km	45
Effective test voltage wire/wire at 50 Hz	V	2,500
Effective test voltage wire/shield at 50 Hz	V	2,500
Operating voltage	V _{ss}	600

Packing on drums.

Wire/core diameter H45 0.9/1.8 mm			
Number of units	External diameter [mm]	Net weight [kg/km]	Standard production length [m]
1	12.0	160	1,000
3	17.0	290	1,000
5	19.0	410	1,000
7	21.0	510	1,000
10	24.0	660	1,000
14	27.0	830	1,000

AJ-2Y2YDB2Y

...x1x0.9 (1.4; 1.8) S LG (...Cu/2B 0....) (H95; H115; H145)

Specification: Dlk. 1.013.107y, Dlk. 1.013.108y, Dlk. 1.013.110y

Application

- » general use in protective devices
- » as underground and conduit cables
- » use in areas with danger of electromagnetic field

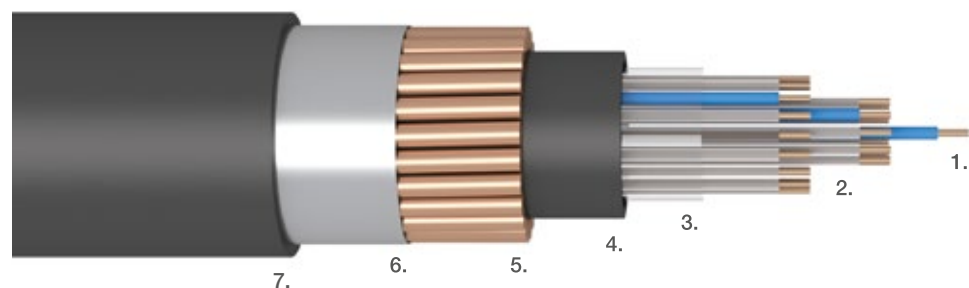

Description of materials:

1. Copper wire.
2. Core insulation – solid PE.
3. Plastic tape.
4. PE inner jacket, black.
5. Anti-induction protection copper wires.
6. Stell armour tape.
7. PE outer jacket, black.

Cable core – conductors stranded in concentric layers.

Environmental conditions

Temperature ranges for laying and assembly	-10 °C ÷ +60 °C
Operation and store temperatures	-40 °C ÷ +60 °C
Permitted minimum bending radius	min. 20D
Cable lifetime	min. 30 years

D – outside cable diameter

Electrical parameters (20 °C)

	mm	0.9	1.4	1.8
Conductor diameter	mm	0.9	1.4	1.8
Max. loop resistance	Ω/km	28.9	11.9	7.2
Insulation resistance	GΩ.km	10	10	10
Effective test voltage wire/wire at 50 Hz	V	2,500	2,500	2,500
Effective test voltage wire/shield at 50 Hz	V	2,500	2,500	2,500
Operating voltage	V _{ss}	600	600	600

Value of reduction factor according to Dlk. 1.013.110y – type code RKZ 601, 602, ...

Packing on drums.

Number of units	Wire/core diameter H145 1.4/2.2 mm			Wire/core diameter H145 1.8/2.7 mm		
	External diameter [mm]	Net weight [kg/km]	Standard production length [m]	External diameter [mm]	Net weight [kg/km]	Standard production length [m]
RKZ 401						
50				38.0	3,630	500
80	37.0	3,500	500	44.0	4,850	500
120	42.0	4,570	500	51.0	6,410	500
160	47.0	5,550	500	56.0	7,910	250
200	51.0	6,460	500	61.0	9,300	250

Number of units	Wire/core diameter H95 1.4/2.7 mm			Wire/core diameter H95 1.8/3.4 mm		
	External diameter [mm]	Net weight [kg/km]	Standard production length [m]	External diameter [mm]	Net weight [kg/km]	Standard production length [m]
RKZ 401						
50	38.0	3,180	1,000	44.0	4,230	500
RKZ 403						
30	32.0	2,350	1,000	37.0	3,100	1,000

Number of units	Wire/core diameter H145 1.4/2.2 mm			Wire/core diameter H145 1.8/2.7 mm		
	External diameter [mm]	Net weight [kg/km]	Standard production length [m]	External diameter [mm]	Net weight [kg/km]	Standard production length [m]
RKZ 403						
50	32.0	2,620	1,000	31.0	2,560	1,000

Number of units	Wire/core diameter H95 1.4/2.7 mm		
	External diameter [mm]	Net weight [kg/km]	Standard production length [m]
RKZ 501			
10	22.0	990	1,000

Number of units	Wire/core diameter H145 1.4/2.2 mm			Wire/core diameter H145 1.8/2.7 mm			Wire/core diameter H95 1.8/3.6 mm		
	External diameter [mm]	Net weight [kg/km]	Standard production length [m]	External diameter [mm]	Net weight [kg/km]	Standard production length [m]	External diameter [mm]	Net weight [kg/km]	Standard production length [m]
RKZ 502									
50							42.0	3,240	500
80							41.0	3,860	500
120	40.0	3,610	500	48.0	5,290	500			
160	44.0	4,470	500	54.0	6,660	250			
200	48.0	5,320	500	59.0	7,960	250			

Number of units	Wire/core diameter H115 0.9/1.5 mm		
	External diameter [mm]	Net weight [kg/km]	Standard production length [m]
RKZ 503			
160	34.0	2,430	1,000
200	36.0	2,810	1,000

Number of units	Wire/core diameter H95 1.4/2.7 mm			Wire/core diameter H95 1.8/3.4 mm		
	External diameter [mm]	Net weight [kg/km]	Standard production length [m]	External diameter [mm]	Net weight [kg/km]	Standard production length [m]
RKZ 504						
10				25.0	1,220	1,000
14	24.0	1,130	1,000	27.0	1,430	1,000
20	27.0	1,360	1,000	30.0	1,760	1,000
30	30.0	1,680	1,000	34.0	2,250	1,000
50	35.0	2,300	1,000			

Number of units	Wire/core diameter H115 0.9/1.5 mm			Wire/core diameter H145 1.4/2.2 mm			Wire/core diameter H145 1.8/2.7 mm		
	External diameter [mm]	Net weight [kg/km]	Standard production length [m]	External diameter [mm]	Net weight [kg/km]	Standard production length [m]	External diameter [mm]	Net weight [kg/km]	Standard production length [m]
RKZ 504									
10	17.0	610	1,000	20.0	840	1,000	22.0	1,050	1,000
20	18.0	770	1,000	23.0	1,150	1,000	27.0	1,540	1,000
30	21.0	940	1,000	25.0	1,420	1,000	30.0	1,930	1,000
50	24.0	1,220	1,000	30.0	1,960	1,000	35.0	2,730	1,000
80	27.0	1,560	1,000	34.0	2,650	1,000			
120	31.0	2,020	1,000						

RKZ 601									
10	17.0	540	1,000	19.0	740	1,000	22.0	950	1,000
20				22.0	1,040	1,000			
30	20.0	830	1,000				29.0	1,770	1,000
50	23.0	1,090	1,000				34.0	2,550	1,000
160							53.0	6,350	500

RKZ 602									
20	18.0	690	1,000				26.0	1,400	1,000
30				25.0	1,290	1,000			
50				29.0	1,790	1,000			
80	26.0	1,410	1,000	34.0	2,470	1,000	40.0	3,620	500
120	30.0	1,850	1,000	39.0	3,370	500	48.0	5,010	500
160	33.0	2,250	1,000	44.0	4,210	500			
200	35.0	2,630	1,000	47.0	5,040	500	58.0	7,600	250

AJ-2Y(L)2YDB2Y

x4x0.9 S (H45) LG (...Cu/2B 0....)

Specification: Dlk.1.013.109y, Dlk.1.013.110y

Application

- » general use in protective equipment
- » underground and conduit cables
- » use in areas with danger of electromagnetic field

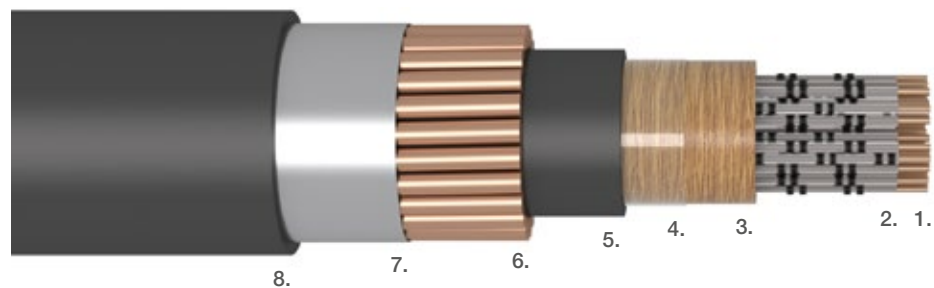

Description of materials:

1. Copper wire.
2. Core insulation – solid PE.
3. Crepe paper.
4. Plastic tape.
5. PE inner jacket, black.
6. Anti-induction protection copper wires.
7. Stell armour tape.
8. PE outer jacket, black.

Cable core – the quads are stranded to the core in concentric layers.

Environmental conditions

Temperature ranges for laying and assembly	-10 °C ÷ +60 °C
Operation and store temperatures	-40 °C ÷ +70 °C
Permitted minimum bending radius	min. 20D
Cable lifetime	min. 30 years

D – outside cable diameter

Electrical parameters (20 °C)

Conductor diameter	mm	0.9
Max. loop resistance	Ω/km	56.6
Insulation resistance	GΩ.km	10
Mutual capacitance	nF/km	45
Effective test voltage wire/wire at 50 Hz	V	2,500
Effective test voltage wire/shield at 50 Hz	V	2,500
Operating voltage	V _{ss}	600

Value of reduction factor according to Dlk. 1.013.110y – type code RKZ 601, 602, ...

Packing on drums.

Wire/core diameter 0.9/1.8 mm			
Number of units	External diameter [mm]	Net weight [kg/km]	Standard production length [m]
RKZ 601			
3	20.1	700	1,000
5	22.4	890	1,000
10	27.0	1,260	1,000
20	32.7	1,880	1,000
30	38.1	2,470	1,000
40	42.1	2,990	1,000
RKZ 504			
3			
5			
10			
RKZ 503			
20			
30			
RKZ 502			
40			
RKZ 403			
5			
10	29.9	1,990	1,000
RKZ 402			
10			
20	36.7	2,860	1,000
30	42.1	3,610	500
40	46.5	4,240	500

3. INSTALLATION CABLES

J-Y(ST)Y

J-H(ST)H

U72 | U72-H

FRQKAHM (QF - INDOOR)

UTP CAT 5, CAT 5E

UTP CAT 3 – 100 Ω

CW1308

J-Y(ST)Y

...x2x0.6 (0.8) LG

Specification: DIN VDE 0815

Application

- » telephone, signaling and data transmission
- » permanent installation on and under plaster in dry or damp rooms, permanent installation on external walls

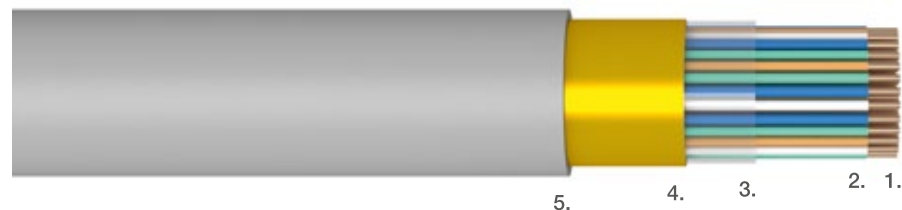

Description of materials:

1. Copper wire.
2. Core insulation – PVC.
3. Plastic tape.
4. Alu/PET tape.
5. PVC outer jacket, grey.

Transmission element – each 2 wires twisted to a pair. Cable core is transmission elements stranded in layers.

Environmental conditions

Temperature ranges for laying and assembly	-5 °C ÷ +50 °C
Operation and store temperatures	-40 °C ÷ +70 °C
Permitted minimum bending radius	min. 10D
Cable lifetime	min. 30 years

D – outside cable diameter

Electrical parameters (20 °C)

	mm	0.6	0.8
Conductor diameter	mm	0.6	0.8
Max. loop resistance	Ω/km	130.0	73.2
Insulation resistance	GΩ.km	100	100
Mutual capacitance	MΩ.km	100 ¹⁾	100 ¹⁾
Capacity unbalance k1 at 800 Hz	pF/100 m	300 ²⁾	300 ²⁾
Effective test voltage wire/wire at 50 Hz	V	800	800
Effective test voltage wire/shield at 50 Hz	V	800	800
Operating voltage	V _{ss}	300	300

¹⁾ in cables up to 4 pairs: 120 nF/km

²⁾ in cables up to 4 pairs only one value can reach max. 500 pF/100 m

²⁾ in cables with more than 4 pairs only 20 % values can reach max. 500 pF/100 m

Packing in coils / on reels / on drums.

Number of units	Wire/core diameter 0.6/0.93 mm			Wire/core diameter 0.8/1.43 mm		
	External diameter [mm]	Net weight [kg/km]	Standard production length [m]	External diameter [mm]	Net weight [kg/km]	Standard production length [m]
Stranded in layers						
1	4.3	30	100, 250, 500, 1,000	5.4	40	100, 250, 500, 1,000
2	4.5	35	100, 250, 500, 1,000	6.1	55	100, 250, 500, 1,000
3	5.4	45	100, 250, 500, 1,000	7.6	75	100, 250, 500, 1,000
4	5.9	50	100, 250, 500, 1,000	8.4	95	100, 250, 500, 1,000
5	6.4	60	100, 250, 500, 1,000	9.3	115	100, 250, 500, 1,000
6	6.8	75	100, 250, 500, 1,000	9.8	130	100, 250, 500, 1,000

Number of units	Wire/core diameter 0.6/1.20 mm			Wire/core diameter 0.8/1.60 mm		
	External diameter [mm]	Net weight [kg/km]	Standard production length [m]	External diameter [mm]	Net weight [kg/km]	Standard production length [m]
Unit stranding						
10	9.0	110	2,000	14.0	200	2,000
20	12.0	195	2,000	19.0	400	2,000
30	15.0	275	2,000	22.0	540	2,000
40	16.5	380	2,000	26.0	780	2,000
50	18.0	430	2,000	28.0	870	1,000
70	21.5	430	2,000	35.0	1,000	1,000
100	24.0	815	1,000	38.0	1,675	1,000
200	40.0	1,500	1,000	51.5	3,100	1,000

J-H(ST)H

...x2x0.6 (0.8) ST III BD FRNC

Specification: DIN VDE 0815

Application

- » distributions in communicating technology, transfers of signals and measured values
- » designed especially for using in areas danger of fire



Description of materials:

1. Copper wire. 2. Core insulation – solid PE. 3. Plastic tape. 4. Alu/PET tape. 5. FRNC outer jacket, grey.

Transmission element – each 4 wires twisted to a star quad, the quads are stranded to units.

Environmental conditions

Temperature ranges for laying and assembly	-5 °C ÷ +50 °C
Operation and store temperatures	-30 °C ÷ +70 °C
Permitted minimum bending radius	min. 10D
Cable lifetime	min. 30 years

D – outside cable diameter

Rings identify the individual conductors



Electrical parameters (20 °C)

Parameter	Unit	0.6	0.8
Conductor diameter	mm	0.6	0.8
Max. loop resistance	Ω/km	133.0	73.2
Insulation resistance	MΩ.km	120	120
Mutual capacitance	nF/km	120	120
Capacity unbalance k1 at 800 Hz	pF/100 m	300	300
Effective test voltage wire/wire at 50 Hz	V	800	800
Effective test voltage wire/shield at 50 Hz	V	800	800
Operating voltage	Vss	300	300

Packing on drums.

Number of units	Wire/core diameter 0.6/1.2 mm			Wire/core diameter 0.8/1.6 mm		
	External diameter [mm]	Net weight [kg/km]	Standard production length [m]	External diameter [mm]	Net weight [kg/km]	Standard production length [m]
2	6.0	85	2,000	7.0	102	2,000
4	8.4	114	2,000	10.5	148	2,000
6	8.8	130	2,000	10.8	174	1,000
10	10.1	165	2,000	13.1	207	2,000
20	13.5	245	2,000	17.0	380	2,000
30	15.6	332	2,000	21.0	543	2,000
40	17.6	413	2,000	24.0	683	2,000
50	19.2	507	2,000	26.5	885	1,000
70	22.0	661	2,000	29.8	1,143	1,000
100	25.9	917	1,000	34.7	1,600	1,000

U72 | U72-H

...x4x0.5 (0.8)

Specification: PTT 844.13

Application

- » telephone, signaling and data transmission
- » permanent installation on and under plaster in dry or damp rooms, permanent installation on external walls



Description of materials:

1. CuSn wire. 2. Core insulation – PVC. 3. Plastic tape. 4. Alu/PET tape. 5. PVC outer jacket, grey.

Transmission element – each 4 wires twisted to a star quad. Cable core is transmission elements stranded in layers.

Environmental conditions

Temperature ranges for laying and assembly	-5 °C ÷ +50 °C
Operation and store temperatures	-30 °C ÷ +70 °C
Permitted minimum bending radius	min. 7.5 × D
Cable lifetime	min. 30 years

D – outside cable diameter

Electrical parameters (20 °C)

	mm	0.5	0.8
Conductor diameter	mm	0.5	0.8
Max. conductor resistance	Ω/km	97.8	37.5
Insulation resistance	GΩ.km	2	2
Mutual capacitance	nF/km	70/60	70/60
Capacity unbalance k1 at 800 Hz	pF/500 m	450	450
Effective test voltage wire/wire at 50 Hz	V	2,000	2,000
Effective test voltage wire/shield at 50 Hz	V	2,000	2,000
Operating voltage	Vss	300	300

Packing in coils / on reels / on drums.

Number of units	Wire/core diameter 0.5/0.9 mm			Wire/core diameter 0.8/1.4 mm		
	External diameter [mm]	Net weight [kg/km]	Standard production length [m]	External diameter [mm]	Net weight [kg/km]	Standard production length [m]
Stranded in layers						
1	5	19	500, 1,000, 2,000	5.6	39	500, 1,000, 2,000
2	7.5	34	500, 1,000, 2,000	8.6	76	500, 1,000, 2,000
3	7	44	500, 1,000, 2,000	9	100	500, 1,000, 2,000
5	8.5	65	500, 1,000, 2,000	11.4	157	100, 250, 500, 1,000
7	9.5	95	2,000	13.5	221	2,000
10	11.5	127	2,000	15	297	2,000
13	12	157	2,000	–	374	–
15	13.5	182	2,000	17	440	2,000
20	15.5	239	2,000	19.5	567	2,000
25	17	292	2,000	22	699	2,000
30	18	340	1,000	23	878	1,000
50	23	548	1,000	29.5	1,452	1,000
60	25	652	1,000			
80	28.5	866	1,000			
100	32	1,085	1,000			

FRQKAHM (QF – INDOOR)

...x4x0.4 (0.6)

Specification: MMD57V4

Application

- » for basic phone services in analogue and digital transmission systems
- » the cables with PVC jacket are designed to be placed in areas with fire spread danger



Description of materials:

1. Copper wire.
2. Core insulation – solid PE.
3. Plastic tape.
4. Laminated aluminium foil.
5. PVC outer jacket, black.

Transmission element – each 4 cores are twisted a star quad, the quads are stranded to units, the units are stranded to the cable core.

Environmental conditions

Temperature ranges for laying and assembly	0 °C ÷ +40 °C
Operation and store temperatures	-30 °C ÷ +50 °C
Permitted minimum bending radius	min. 10D
Cable lifetime	min. 30 years

D – outside cable diameter

Electrical parameters (20 °C)

	mm	0.4	0.6
Conductor diameter	mm	0.4	0.6
Max. loop resistance	Ω/km	300	130
Insulation resistance	GΩ.km	min. 10	min. 10
Mutual capacitance	nF/km	43 ± 3	43 ± 3
Capacity unbalance k1 at 800 Hz	pF/500 m	800	800
Effective test voltage wire/wire at 50 Hz	V	600	600
Effective test voltage wire/shield at 50 Hz	V	2,000	2,000
Operating voltage	Vss	250	250

Packing on drums.

Number of units	Wire/core diameter 0.4/0.73 mm			Wire/core diameter 0.6/1.07 mm		
	External diameter [mm]	Net weight [kg/km]	Standard production length [m]	External diameter [mm]	Net weight [kg/km]	Standard production length [m]
1	–	–	–	5.5	34	2,000
5	9.3	81	2,000	8.6	74	2,000
10	10.9	120	2,000	11.2	129	2,000
15	11.7	154	2,000			
25	14.4	237	2,000			
50	18.4	409	2,000			
75	21.8	584	1,000			
100	25.2	772	1,000			

UTP CAT 5, CAT 5E

4x2xAWG 24 PVC (FRNC)

Specification: EIA/TIA 568/A, ISO/IEC 11801, EN 50173

Application

- » installation LAN net
- » data transfer



Description of materials:

1. Copper wire. 2. Core insulation – solid PE. 3. PVC or FRNC outer jacket.

Transmission element – every 2 conductors stranded in pair.

Environmental conditions

Temperature ranges for laying and assembly	-5 °C ÷ +40 °C
Operation and store temperatures	-30 °C ÷ +60 °C
Transport and store temperatures	-40 °C ÷ +70 °C
Permitted minimum bending radius	min. 10D
Cable lifetime	min. 30 years

D – outside cable diameter

Colour conductors

Pair No.	A – conductor	B – conductor
1	white with blue rings	blue
2	white with orange rings	orange
3	white with green rings	green
4	white with brown rings	braun

Electrical parameters (20 °C)

Conductor diameter	mm	0.5
Max. loop resistance	Ω/km	93.8
Insulation resistance	GΩ.km	10
Mutual capacitance	nF/km	56
Mean impedance	Ω	100 ± 15
Max. capacity unbalance	pF/500 m	330
Min. Structural Return Loss (SRL) 1–20 MHz	dB/100 m	23
20–100 MHz		23–10 log (f/20)
Max. attenuation	dB/100 m	1.967 × √f + 0.023 f ± 0.05 /√f
Min. near END Crosstalk (NEXT)	dB/100 m	23–15 log (f/0.772)

Packing – boxes, reels.

UTP CAT 3 – 100 Ω

x2xAWG 24 PVC (x2xAWG 24 FRNC)

Specification: EIA/TIA 568/A, ISO/IEC 11801, EN 50173

Application

- » installation LAN net
- » data transfer



Description of materials:

1. Copper wire. 2. Core insulation – solid PE. 3. Plastic tape. 4. PVC or FRNC outer jacket.

Transmission element – every 2 conductors stranded in pair.

Environmental conditions

Temperature ranges for laying and assembly	-10 °C ÷ +60 °C
Operation temperatures	-20 °C ÷ +60 °C
Permitted minimum bending radius	min. 10D
Cable lifetime	min. 30 years

D – outside cable diameter

Electrical parameters (20 °C)

Conductor diameter	mm	0.5
Insulation resistance	GΩ.km	10
Max. resistance of the conductor	Ω/km	93.8
Max. mutual capacity of the pair	nF/km	56
Max. capacity unbalance	pF/100 m	330
Min. Structural Return Loss (SRL) 1–10 MHz	dB/100 m	12
Max. attenuation	dB/100 m	2.32 × √f + 0.238 f
Min. near END Crosstalk (NEXT)	dB/100 m	43–15 log (f/0.772)

Packing – boxes, reels

Number of units	External diameter [mm]	Net weight [kg/km]	Standard production length [m]
25	11.5	134	1,000
50	16.5	300	1,000
100	23.5	600	1,000
200	31.5	1,150	1,000
300	39.0	1,700	1,000

CW 1308

...x2x0.5

Specification: CW1308

Application

- » connection cables in Local Area Networks and in private branch exchanges for telephony and signal transfer
- » indoor cable



Description of materials:

1. Copper wire.
2. Core insulation – PVC.
3. Plastic tape.
4. Wrapping ALU/PET tape+CuSn.
5. PVC outer jacket, grey.

Transmission element – twin pair twisted to units.

Environmental conditions

Temperature ranges for laying and assembly	-10 °C ÷ +60 °C
Operation and store temperatures	-40 °C ÷ +70 °C
Permitted minimum bending radius	min. 10D
Cable lifetime	min. 30 years

D – outside cable diameter

Packing on drums.

Wire/core diameter 0.5/0.9 mm

Coding	External diameter [mm]	Standard production length [m]	Coding	No. of pairs	Make up
2,503	5.0	2,000	2,503	3P	3
2,504	5.6	2,000	2,504	4P	4
2,506	6.8	1,000	2,506	6P	6
2,510	8.3	1,000	2,510	10P	2 + 8
2,512	9.1	1,000	2,512	12P	3 + 9
2,516	10.2	1,000	2,516	16P	4 × (4 × 2)
2,515	9.8	1,000	2,515	15P	3 × (5 × 2)
2,520	10.7	1,000	2,520	20P	4 × (5 × 2)
2,525	11.4	1,000	2,525	25P	5 × (5 × 2)
2,530	12.2	1,000	2,530	30P	6 × (5 × 2)
2,532	12.4	1,000	2,532	32P	4 × (8 × 2)
2,540	15.0	1,000	2,540	40P	4 × (10 × 2)
2,550	17.0	1,000	2,550	50P	5 × (10 × 2)
2,564	16.5	1,000	2,564	64P	1 × (16 × 2) + 6 × (8 × 2)
2,580	22.5	1,000	2,580	80P	1 × (20 × 2) + 6 × (10 × 2)
2,581	27.0	1,000	2,581	100P	1 × (20 × 2) + 8 × (10 × 2)
2,566	25.4	1,000	2,566	128P	4 × (8 × 2) + 6 × (16 × 2)
2,582	30.3	1,000	2,582	160P	4 × (10 × 2) + 6 × (20 × 2)
2,583	33.0	1,000	2,583	200P	2 × (20 × 2) + 8 × (20 × 2)
2,568	35.2	1,000	2,568	256P	1 × (16 × 2) + 5 × (16 × 2) + 10 × (16 × 2)
2,584	39.5	1,000	2,584	320P	1 × (20 × 2) + 5 × (20 × 2) + 10 × (20 × 2)

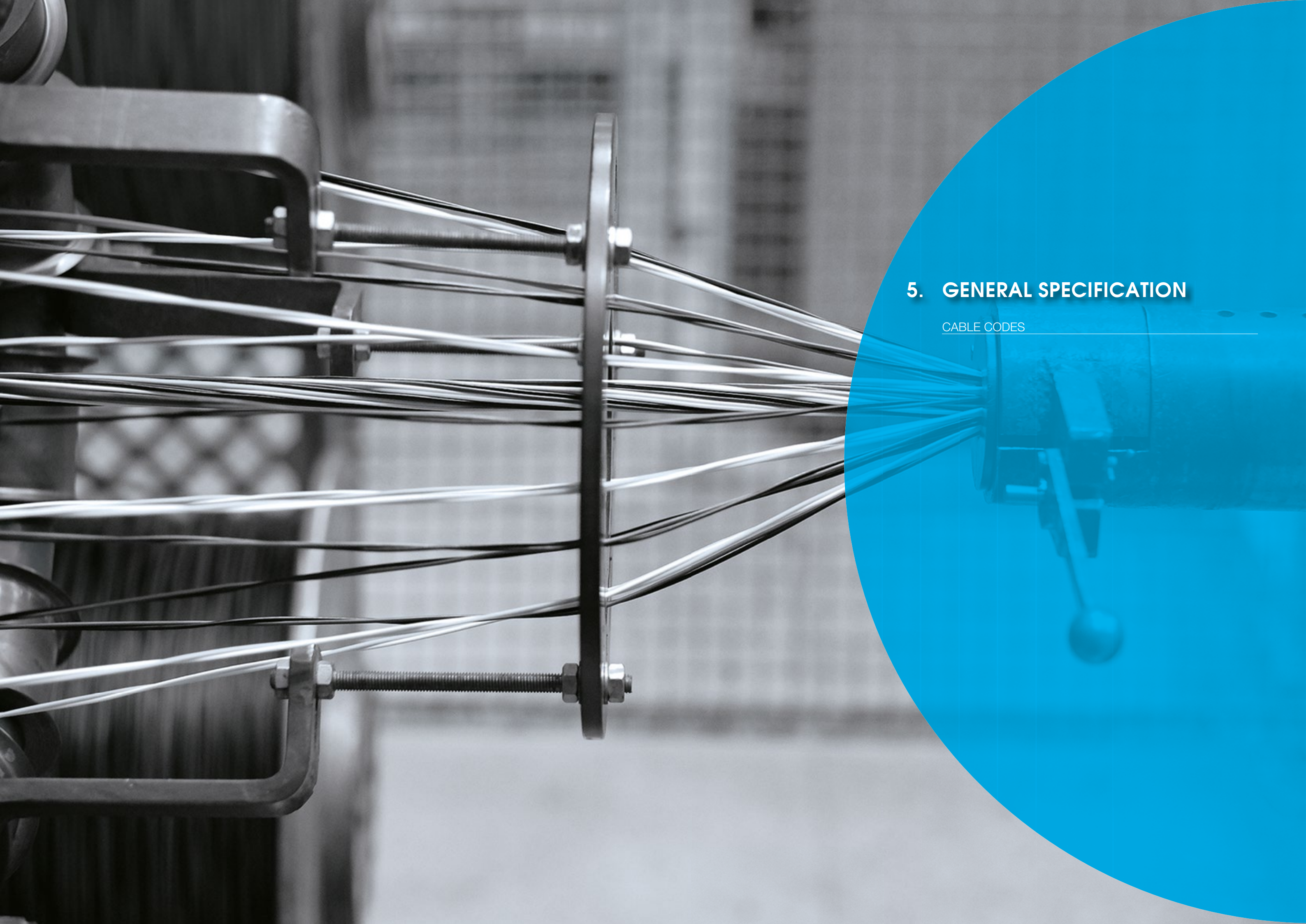

5. GENERAL SPECIFICATION

CABLE CODES

Cable Codes

TELECOMMUNICATION

A	outdoor cable
2Y	PE conductor insulation
02YS	foam skin PE conductor isolation
F	cable core filled
(L)2Y	laminated sheath (PE+AL tape)
ST III	star quad in cable
BD	unit stranding
H(N)	operating capacity of the pair
H	local telephone cable
R	copper core
QHQ	foam skin PE insulation
Z	jelly filling
K	space in the denomination
AH	aluminium foil applied-longitudinally
Q	PE sheath
AK	round alu wire
V	steel tape
L	aerial telephone cable
T	telecommunication cable
C	copper conductor
EP	PE skin foam skin conductor insulation
K	cable
P	filling compound
FL	static shield
E	PE sheath (inner sheath)
Y	PVC outer sheath
Z	AL wires armor
S	messenger wire
H	FRNC sheath

INSTALLATION

J	installation cable
Y	PVC conductor insulation
(ST)	static shield
Y	PVC sheath
LG	stranded in layers
ST III	star quad
BD	unit stranding
H	FRNC conductor insulation
FRNC	flame retardant non halogen
R	copper core
Q	solid PE insulation
K	space in the denomination
M	PVC sheath
UTP	unscreened cable
4 x 2	structure cable core – 4 pairs
AWG 24	diameter Cu core – 0.5 mm
PVC	sheath of PVC

SIGNAL

A	outdoor cable
AJ	outdoor cable with anti-inductive protection
2Y	solid PE conductor insulation
2YV	PE sheath with increased wall thickness
(L)2YV	laminated sheath with increased wall thickness
S	signal cable
AJ	inductive
H	halogen free conductor insulation
L(H)	laminated halogen free sheath (AL tape + FRNC)
LG	stranding in layers
FR	flame rezistivity
NC	non corrosive
P	unscreened pairs
PIMF	screened pairs
J	protective conductor
(R...)	armor wires diameter
VZK	galvanized wires
(...AL)	total cross section of AL wires
B	steel tape armor
D	copper wire concentric screen

6. INSTALLATION AND MANIPULATION

MANIPULATION AND STORAGE

REWINDING/UNWINDING OF CABLE

BEND RADIUS OF CABLE

A-02YSP

(L)2Y

200x2x0.5

Manipulation and Storage

The drums with the cables cannot be thrown from any heights! The drums with optical cables have to always stand on the edges of the head, secured with a wedge to prevent movement. The only time when it is not necessary to secure the drums with a wedge is when the drums are mutually secured between each other by standing them crosswise. /Pic. 1

Cables intended for internal use can only be stored in closed areas without humidity. Cables for universal and outdoor use can be stored in outdoor conditions. However, the cable ends have to be waterproof. However, if the cable is on a plywood spool, it has to be stored in such a manner so as to prevent the effects of water on the spool.

When manipulating with the drums using a crane, a spacer rod has to be placed between the load bearing ropes, so that the ropes do not exert pressure on the cable through the side drums. /Pic. 2

When lifting the drums using a forklift, the drums can only be gripped from the sides and only when the skids of the forklift are long enough for the head of the drum to be positioned on it with a safe overhang. /Pic. 3

It is only possible to roll the drums short distances and only on a hard and flat surface.



Pic. 1

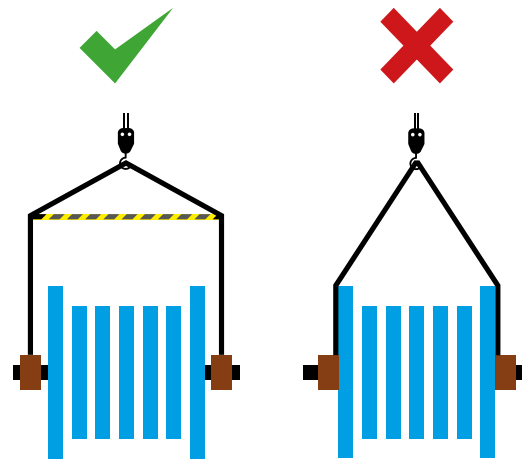

Pic. 2

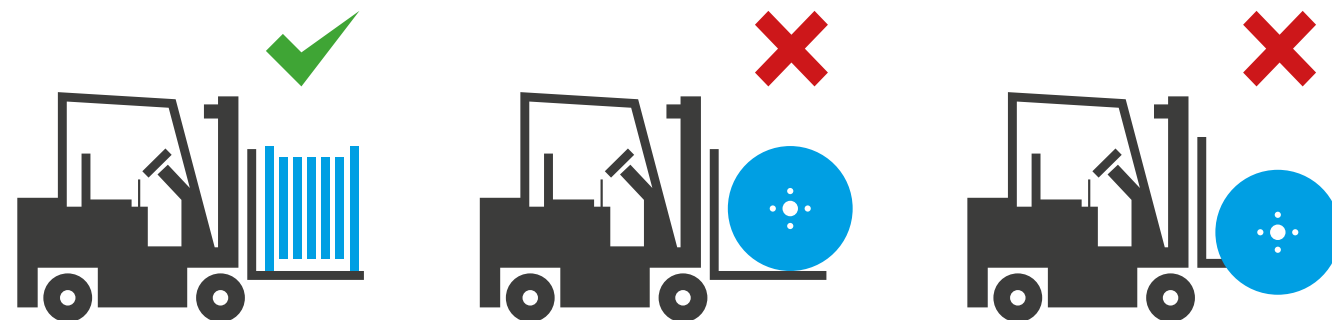

Pic. 3

Rewinding/Unwinding of Cable

The rewinding and unwinding of cables is only possible in temperature above 5 °C. If for any reason, it is necessary to unwind the cable in a lower temperature, the cable has to be left at a minimum temperature of 20 °C for at least 24 hours beforehand. For rewinding the cable, the winding (bending) direction of the cable has to be maintained, unwinding cannot form an "S" shape. /Pic. 4

When unwinding the cable, it is necessary to maintain continuous pull without variation. Unwinding without pull can then lead to the loosening of individual rolls and to the consequent mutual under pull, possibly to the uncontrolled, sharp tugging of the cable, resulting in the damaging of the optical fibers.

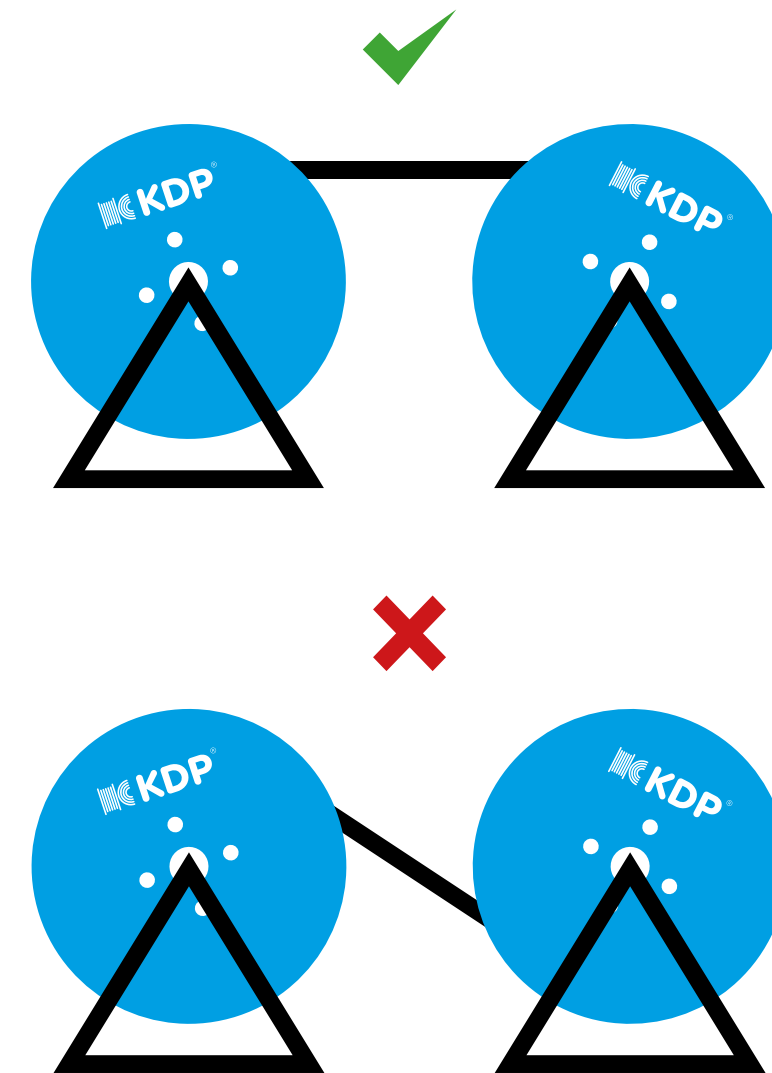

Pic. 4



KABELOVNA Děčín Podmokly, s.r.o.

Ústecká 840/33 | 405 33 Děčín | Czech Republic

Phone: +420 412 706 111 | **E-mail:** sales@kabelovna.cz

www.kabelovna.cz