

Cables, Wires and Accessories for Industrial Applications



**Be certain.
Belden.**

**Signal Transmission Solutions
for Reliable, Mission-Critical
Applications**

BELDEN
SENDING ALL THE RIGHT SIGNALS

Keep productivity high and downtime low with Belden industrial cables. From industrial automation and process control to wind turbines and robotics, Belden has the cable that combines reliability, ruggedness, and performance.

**Be certain.
Belden.**



Section Index

	Page
Table of Contents	4–8
Power & Control	
■ Multi-Conductor Cables	13
■ Paired and Triads Cables	75
■ Variable Frequency Drive (VFD) Cables	139
■ Sensor & Actuator Cables	151
■ Hook-up & Lead Wire	157
■ Portable Cordage	187
Data Communication Systems	
■ Computer Cables	197
Industrial Data and Process Automation	
■ Serial Fieldbus	225
■ DataTuff® Industrial Ethernet Cables	251
■ DataTuff® Industrial Ethernet Patch Cords	269
■ RailTuff™ Railway Approved Industrial Ethernet	275
Optical Fiber	
■ Central and Multi Loose Tube	279
Patching and Termination	
■ MIPP: The Industrial-strength Patch Panel	331
Technical Information	343
Part Number Index	365

Table of Contents

	Page
Table of Contents	4–8
Trust Belden Cable to Ensure Clear, Uninterrupted Signal Transmission	9
Top of Class Performance	10–11
Bringing Added Value with Industry-leading Support	12
Power & Control	
Multi-Conductor Cables	
Overview	14
Classic Multi-Conductor Cables	15
Overview	15
Audio, Control and Instrumentation Cables	16–23
High-Temperature Control and Instrumentation Cables	24–26
Special Audio, Communication and Instrumentation Cables	27–28
Fire Alarm Power-Limited Fire Protective Signaling Circuit Cables	29–30
Plenum-Rated Fire Alarm Power-Limited	31
Circuit Integrity (CI) SAFE-T-Line® Cables	32–35
Computer, Instrumentation and Medical Electronics Cables	36
MIL-W-16878 (Type B) Conductors	37
Security Systems and Duplex Primary Wire	38
Antenna Rotor Cables	39
Rubber SO Power and Control Cables	39
MachFlex Flexible Control Cables	40
Overview and Application Guide	40–41
600 V MachFlex Super 360TC for Extreme Flexing (10 Million Flex Cycles)	42–43
600 V MachFlex 360TC for Moderate Flexing (1 Million Flex Cycles)	44–46
UL Control Cables	47
600 V Type TC Cables	47–53
600 V Type MC Metal Clad and Teck-Style® Cables	54–57
Dual Rated UL/CSA Control Cables	58
600 V Teck-Style® Cables: Dual-Rated Type MC/TECK 90	58–60
CSA Control and Power Cables	61
600 V and 1000 V TC/CIC Multi-Conductor Cables	61–62
CSA Control Cables	63
600 V CIC Multi-Conductor Cables	63–64
600 V ACIC Cables and TECK 90 Cables	65–68
600 V TECK 90 Composite Cables	69
1000 V TECK 90 Cables	70–71
Technical Information	72
Paired and Triads Cables	
Overview	76
Classic Paired Cables	77
Overview and Selection Guide	77–84
Special Audio, Communication and Instrumentation Cables	85–86
Audio, Control, and Instrumentation Cables	87–103
UL Instrumentation Cables	104
300 V Power-Limited Tray Cables	104–118
Thermocouple Extension Cable and Thermocouple Wire	119–121
600 V Tray Cables	122–131



Power & Control	Page
Paired and Triads Cables	
CSA Instrumentation and Thermocouple Tray Cable	132
300 V TC/CIC	132–133
CSA Instrumentation Cables	134
300 V CIC	134–135
300 V ACIC Armored Cables	136–138
Variable Frequency Drive (VFD) Cables	
Overview	140–141
Cross Reference Guide	142–144
Classic and Symmetrical VFD Cables	145–146
Low Smoke Zero Halogen VFD Cables	147–148
Armored VFD Cables	149
CSA VFD Cables	150
Sensor & Actuator Cables	
Overview	152
PVC Sensor & Actuator Cables	153
PUR Sensor & Actuator Cables	154
PUR Distribution Boxes Cables	155
Hook-up & Lead Wire	
Overview	158
Introduction: UL Style & CSA Type Listings	159
PVC	160–163
PVC Wire Dispenser Kits	164
GreenChoice™ PPO	165
TFE	166–167
EPDM	168–169
XL-DUR®	170
XL-DUR® (High-Temperature) and SIS (Switchboard) Wire	171
Chlorosulfonated Polyethylene	172–173
Neoprene	174
Silicone Rubber	175–176
Mercury Switch	177
High-Voltage Leads	177
Test Prod Wire	177
Magnet Wire	178
Shielding and Bonding Cable, Direct Burial Cable, Bus Bar, and Antenna Wire	179
Technical Information	180–186
Portable Cordage	
Overview	188
Introduction	189
2-Conductor	190–191
3-Conductor	192–193
4-, 5- and Multi-Conductor	194
UL Cordage Types: Designation, Construction and Rating	195

Table of Contents (continued)

Data Communication Systems	Page
Computer Cables	
Overview	198
Multi-Conductor Computer Cables	199
Computer Cables for RS-232 Applications	199–200
Computer Cables for RS-232, RS-423, and IEEE 488	201
Low-Capacitance Computer Cables for RS-232 Applications	202
Low-Capacitance Computer Cables for RS-232 and RS-423 Applications	203
Paired Computer Cables	204
Computer Cables for RS-232 Applications	204–205
Low-Capacitance Computer Cables for RS-232 and RS-422 Applications	206
Low-Capacitance 100 Ohm Computer Cables for RS-422 and Digital Audio Applications	207–208
Low-Capacitance Computer Cables for RS-232 Applications	209
Low-Capacitance Computer Cables for RS-232 and RS-422 Applications	210–211
Low-Capacitance Computer Cables for RS-232, RS-422, and RS-485 Applications	212
Low-Capacitance Computer Cables for RS-485 Applications	213
Computer POS Cables	214
Low-Capacitance Computer Cables for RS-232, RS-422 and Digital Audio Applications	215
Industrial Data and Process Automation	
Overview	218
Introduction	218–219
PLC/DCS-to-Cable Cross Reference Guide	220–222
Protocol-to-Cable Cross Reference Guide	223–224
Serial Fieldbus	
Overview	226
Foundation Fieldbus Type A	227–229
Foundation Fieldbus Type B	230
PROFIBUS	231–232
CANopen RS-485	233–234
DeviceBus® for ODVA DeviceNet™	235–236
DeviceBus® for Honeywell Smart Distributed System	237
DeviceBus® for Square D/Seriplex® and Phoenix Contact INTERBUS®-S	238
ControlNet™	239
ControlBus™	240–242
MODBUS for RS-232	243
MODBUS II for RG-6 Type Coaxial Cables	243
LonWorks	244
DataTray® 600 V Twinaxial	245
CC Link	246
KNX/EIB Approved Cables	247
Coaxial Ethernet	248
MachFlex Flexible Automation Cables	249
300 V MachFlex Data Cables (1 Million Flex Cycles)	249
MachFlex Vision 75 Ohm Coax Cables (1 Million Flex Cycles)	249



Industrial Data and Process Automation	Page
DataTuff® Industrial Ethernet Cables	
Overview	252
Introduction and Cable Selection Guide	253–256
DataTuff® Industrial Ethernet	257
Permanent Installation Cables	257–261
Moderate Flexing Cables	262–264
Continuous Flexing Cables	265
DataTuff® PROFINET	266
Permanent Installation Cables	266
Moderate Flexing Cables	267
Continuous Flexing Cables	268
DataTuff® Industrial Ethernet Patch Cords	
Overview	270
DataTuff® Industrial Ethernet Patch Cords	271
Twisted Pair Cables	271–272
Bonded Pair Cables	273–274
RailTuff™ Railway Approved Industrial Ethernet	
Overview	276
RailTuff™ Railway Approved Industrial Ethernet	277
Optical Fiber	
Overview	280
Loose Tube Optical Characteristics	281
Construction Lookup Table	282
Part Number Coding	283
Central Loose Tube	284–309
Multi Loose Tube	310–327
Technical Information	328–330
Patching and Termination	
MIPP – The Industrial-strength Patch Panel	
Overview	332–333
MIPP Fiber Splice Box	334
Overview	334
Standard Part Number Reference Guide	335
Standard Part Number Reference List	336–337
MIPP Copper Patch Panel	338
Overview	338
Standard Part Number Reference Guide	339
Standard Part Number Reference List	339
MIPP Mix	340
Overview	340
Standard Part Number Reference List	341
Accessories	342

Technical Information	Page
Belden Conductor Color Code Charts	344–345
Conductors	346–348
Insulations and Jackets	349–352
Shielding	353–355
Cables Standards Reference Guide	356
Cables Substitution Chart	357
Canadian Substitution Hierarchy and Catalog Terms of Use	358
Glossary	359–363
Part Number Index	
Part Number Index	366–392



Be certain of a partner who understands your industry.



Trust Belden Cable to Ensure Clear, Uninterrupted Signal Transmission

Today's industrial applications cannot afford transmission errors that cause downtime, delays, and even safety concerns. Belden quality provides the performance and reliability needed to keep your connections strong and your automation up and running, even in the harshest operating environments.

- Patented, proven technology for maximum uptime
- Broad portfolio to meet any need
- Above-and-beyond service and support

Designing Solutions for Unmatched Reliability

Noise, vibration, humidity, temperature, sunlight, flexing, chemicals and so many other factors can impact signal performance. The consequences can be significant, depending on the scope of the resulting shutdown, the mission-critical level of the application and the vertical market or industry involved. Whatever the cost, your bottom line suffers.



That's why so many project designers write Belden cables into their project specs. The experts know that when it comes to reliability, Belden has no equal.

Belden's Bonded-Pair technology, a patented cable construction that affixes the conductor insulation of the cable pairs along their longitudinal axes, ensures that no performance-robbing gaps can develop. The design also prevents noise interference with the signal in the cable.

- Conductor-to-conductor spacing, or centricity, is always uniform – no gaps
- With uniform centricity, cable delivers consistently reliable electrical performance
- Superior electrical performance, even after cable is subjected to bending, pulling and twists

Installed and manipulated Nonbonded-pairs (left) have a tendency to gap, varying the centricity of the two conductors. Belden Bonded-Pairs (right) do not gap so the physical integrity of the pair is maintained.

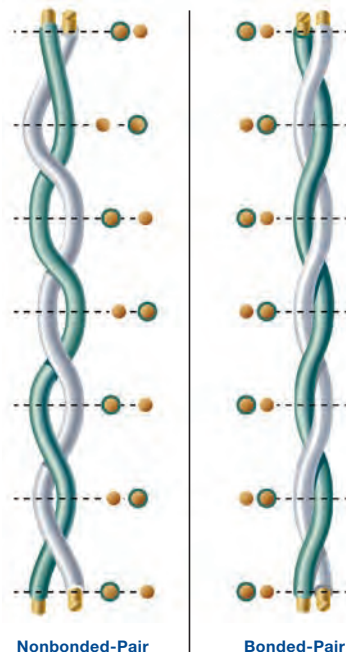

Belden is a dynamic and an innovative company with a vast product portfolio.

Top of Class Performance

Belden has developed the most comprehensive line of industrial cables, wires and accessories in the world today.



Operating as a lean enterprise, Belden puts a high priority on what you need. Our manufacturing sites and products meet or exceed the certification requirements of multiple, independent certification agencies, including:

- **UL (Underwriters Laboratories)**

UL Standards are used to assess products; test components, materials, systems and performance; and evaluate environmentally sustainable products, renewable energies, food and water products, recycling systems and other innovative technologies in order to fulfill its mission to create a safer, more sustainable world.

- **ISO (International Organization for Standardization)**

ISO Standards give world-class specifications for products, services and systems, to ensure quality, safety and efficiency. They are instrumental in facilitating international trade.

- **RoHS (Restriction on Hazard Substances)**

Nearly all Belden cables contain none of the restricted substances under the European Directives of 2002/2003 or California Proposition 65.

Plus, we've built our entire corporate culture around continuous improvement. Every action is taken to earn your trust and protect your mission-critical applications.



Delivering the Right Product for Every Application

From copper to fiber. From fieldbus to Ethernet. From unshielded to armored. From on-machine to buried underground. No matter what you need, you'll find a solution in the Belden portfolio.

In business since 1902, Belden has grown into a worldwide enterprise with more than 25 sales offices and manufacturing facilities spread across North and South America, Europe, Asia Pacific, Africa and the Middle East. That means worldwide market access and global distribution to supply any project you have.

You'll also find experience and expertise across diverse industries and vertical markets. Having introduced more than 250,000 products to the market and earned more than 600 patents for innovation, we've successfully completed projects in:

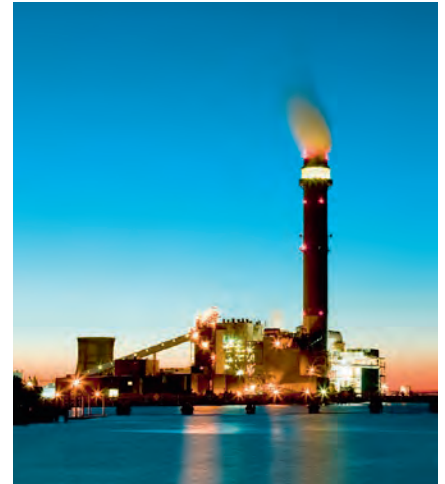

Markets	Applications
Automotive	Network/Fieldbus Infrastructure
Machine Building/Manufacturing	Sensor/Actuator Connectivity
Food & Beverage	Ethernet Automation
Consumer Packaging	Physical Security & Surveillance
Chemical & Petrochemical	Industrial Internet of Things
Transportation	Smart Factory/Industrie 4.0
Oil & Gas	Smart Grids
Power, Transmission & Distribution	Cybersecurity
Utilities/Energy	Robotics/Automation
Medical & Healthcare	Multi-protocol
& More	



Bringing Added Value with Industry-leading Support

When you choose Belden, you can operate with confidence. Our entire industrial cable portfolio is backed by our 10-year extended warranty – FREE. That's unmatched coverage you can only get from Belden.

In every region of the world, you have access to a Commercial Engineering "Coach" who can guide you through any project, from planning and design to implementation and troubleshooting. We can also connect you to certified partners and authorized systems integrators to ensure your success and satisfaction.

Plus, we invest in you. Every year, we offer countless opportunities to expand your knowledge – from our highly rated annual Design Seminar and formal certification courses to interactive webinars, a weekly blog, and a bi-monthly newsletter.

The more you know, the more you'll agree: Belden is the right choice for your industrial project.



Belden is leading the way in the transformation to a connected world.

Power & Control Multi-Conductor Cables



Section Table of Contents

Power & Control	
Multi-Conductor Cables	
Overview	14
Classic Multi-Conductor Cables	
Overview	15
Audio, Control and Instrumentation Cables	16–23
High-Temperature Control and Instrumentation Cables	24–26
Special Audio, Communication and Instrumentation Cables	27–28
Fire Alarm Power-Limited Fire Protective Signaling Circuit Cables	29–30
Plenum-Rated Fire Alarm Power-Limited	31
Circuit Integrity (CI) SAFE-T-Line® Cables	32–35
Computer, Instrumentation and Medical Electronics Cables	36
MIL-W-16878 (Type B) Conductors	37
Security Systems and Duplex Primary Wire	38
Antenna Rotor Cables	39
Rubber SO Power and Control Cables	39
MachFlex Flexible Control Cables	
Overview and Application Guide	40–41
600 V MachFlex Super 360TC for Extreme Flexing (10 Million Flex Cycles)	42–43
600 V MachFlex 360TC for Moderate Flexing (1 Million Flex Cycles)	44–46
UL Control Cables	
600 V Type TC Cables	47–53
600 V Type MC Metal Clad and Teck-Style® Cables	54–57
Dual Rated UL/CSA Control Cables	
600 V Teck-Style® Cables: Dual-Rated Type MC/TECK 90	58–60
CSA Control and Power Cables	
600 V and 1000 V TC/CIC Multi-Conductor Cables	61–62
CSA Control Cables	
600 V CIC Multi-Conductor Cables	63–64
600 V ACIC Cables and TECK 90 Cables	65–68
600 V TECK 90 Composite Cables	69
1000 V TECK 90 Cables	70–71
Technical Information	
	72

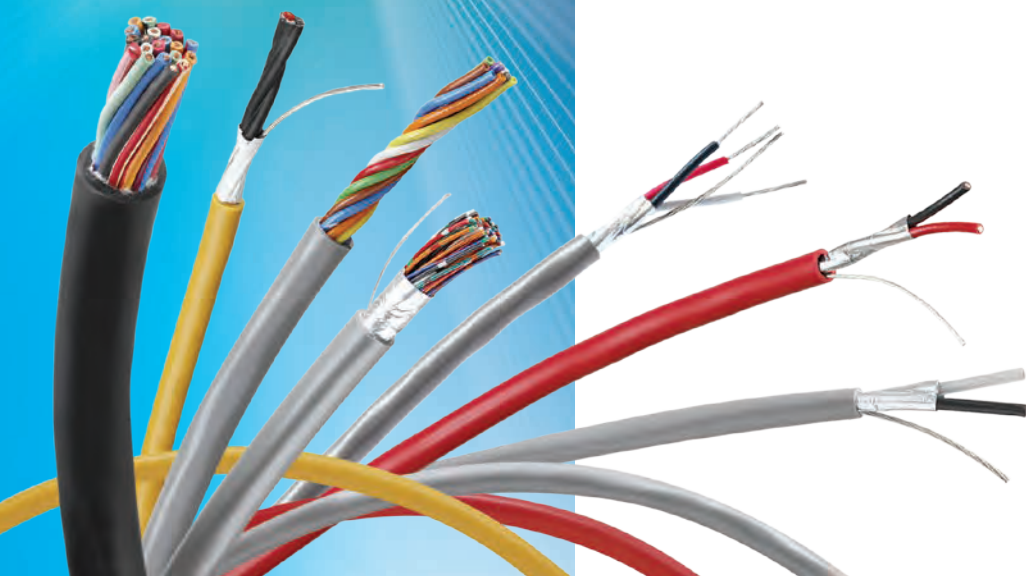

Multi-Conductor Cables



Product Features

Belden multi-conductor products deliver low voltage analog data signals within enclosures, from controllers and I/Os to devices such as temperature and pressure sensors, relays, valves, meters, thermocouples, solenoids, actuators, contacts, push buttons, and alarms. They also are applicable for computers, communications, instrumentation, sound, control, audio, data transmission, and many more applications.

- Unsurpassed quality and reliability
- Robust designs that meet or exceed UL standards
- Proven performance in installations worldwide
- Broad range of AWG sizes, shielding options, and conductor counts
- Convenient put-up options
- Polyolefin insulations provide lower capacitance performance when compared to PVC insulated cables

Applications

Belden's multi-conductor line includes a select number of high-quality, high-reliability cables that meet or exceed UL standards and have been used worldwide for decades.

Multi-conductor Computer Cable is suitable for process control networks, industrial automation and building automation systems such as heating, ventilation, air conditioning (HVAC) and security systems. It is ideal for data transmission between multiple systems and often in long distance links (up to 4,000 ft/1,219 m).

Fire protective control and circuit integrity cables ensure the continued operation of a building's EVAC systems in the event of fire are suitable for a wide range of applications, including security systems, sound and intercom systems, power-limited controls, fire and burglar alarm systems, single-line telephones, and more.

The Fire Alarm range is approved by NEC/CEC and California State Fire Marshall for commercial fire alarms, monitoring and detection systems, audio and control and notification circuits.

When the application demands highly flexible cables offering exceptional cable life and performance, Belden MachFlex offers the best solution.

For installation in wet or dry locations the UL control cables are recommended. Cable jackets are resistant to sunlight, moisture and vapor penetration. The cables can be used in raceways, outdoor applications and direct burial applications.

CSA Control cables are general-purpose cables used in the oil and gas, pulp and paper, mining, petroleum and chemical industries as well as in commercial buildings.

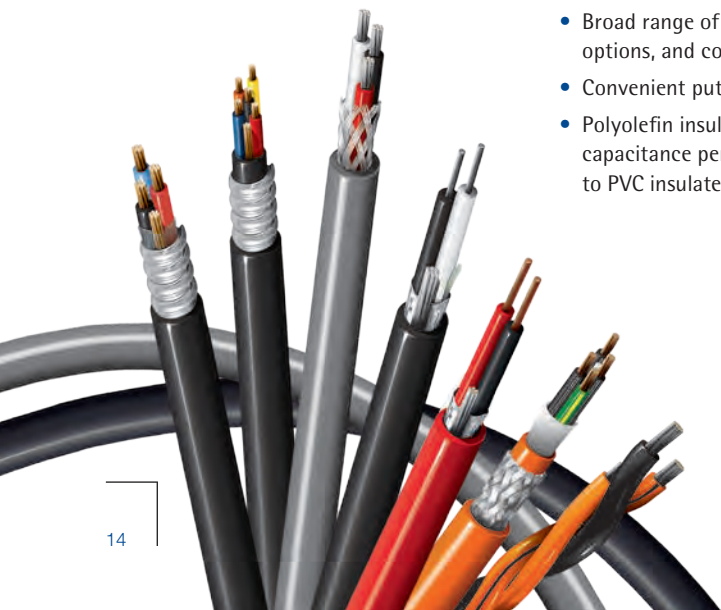

Classic Multi-Conductor Cables

Shielding

Belden meets the demand for highly effective shielding technology with innovative, EMI/RFI-protective foil and braid designs like Beldfoil®. Belden's patented Beldfoil shield is an aluminum/polyester foil construction that yields a lightweight, strong, flexible and thin shield that provides extra insulation and 100% shield coverage. Beldfoil is ideally suited for multiple-pair, individually shielded audio, communication, and data cables.

Product Consistency

By manufacturing our products in ISO-certified, state-of-the-art manufacturing facilities, Belden assures that quality is built into each and every product. Precise diameter control of insulation and jacket diameters and concentric wall thickness assures fast, reliable manufacturing in high-speed automated equipment, and ease of termination and assembly in the field.

Find the Right Product for Your Application

Belden Classic products are available from stock from Belden distributors. If the products above do not fit your application, Belden can also engineer specific constructions for your application.

Audio, Control and Instrumentation Cables

600 V, +80 °C • Unshielded



- C(UL) FT4
- VW-1

Part No.	Conductors	Color Code	OD (Nom)		Insulation Thickness		Jacket Thickness	
			Inch	mm	Inch	mm	Inch	mm

Stranded (19 x 29) TC Conductors • PVC Insulation • Cabled • Chrome PVC Jacket

16 AWG • 19 x 29 • PVC/PVC

8620	4	Chart 2	.376	9.55	0.31	.79	.042	1.07
9620	5	Chart 2	.411	10.44				
8621	7	Chart 2	.458	11.63				
9721	8	Chart 2	.496	12.60	0.31	.79	0.45	1.14
9621	9	Chart 2	.533	13.54				
8622	12	Chart 2	.627	15.93	0.31	.79	.060	1.52
8623	15	Chart 2	.694	17.63				
8624	19	Chart 2	.740	18.80				
9622	25	Chart 2	.879	22.33	0.31	.79	.065	1.65

14 AWG • 19 x 27 • PVC/PVC

8627	4	Chart 2	.490	12.45	.045	1.14	.045	1.14
9623	5	Chart 2	.573	14.55	.045	1.14	.060	1.62
8628	7	Chart 2	.623	15.82	.045	1.14	.060	1.62
8629	12	Chart 2	.824	20.93	.045	1.14	.065	1.65

Audio, Control and Instrumentation Cables

300 V, +60 °C • Unshielded



- UL AWM Style

- NEC: CM
- CEC: CM
- NEC: MP (9794 Only)

Part No.	Conductors	Color Code	OD (Nom)		Insulation Thickness		Jacket Thickness	
			Inch	mm	Inch	mm	Inch	mm

22 AWG • Polyolefin/PVC

Solid BC Conductors • Polyolefin Insulation • Cabled • Rose or Gray PVC Jacket								
8795	2	Green, Red	.168	4.27				
8794	3	Green, Red, Yellow	.178	4.52	.018	.46	.022	.56
9794	4	Green, Red, Yellow, Black	.200	5.08				
1242A	4	Green, Red, Yellow, Black	.154	3.91	.018	.46	.025	.64

300 V, +60 °C • Unshielded

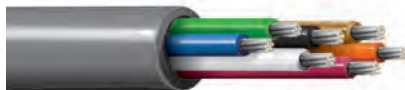

- PVC/PVC
- AWM Style

- NEC: CMG
- CEC: CMG FT4

Part No.	Conductors	Color Code	OD (Nom)		Insulation Thickness		Jacket Thickness	
			Inch	mm	Inch	mm	Inch	mm

Stranded TC Conductors • PVC Insulation • Cabled • Chrome PVC Jacket

20 AWG • 7 x 28 • PVC/PVC

9444	4	Chart 1	.217	5.51				
9445	5	Chart 1	.239	6.07	.015	.38	.032	.81
9439	7	Chart 1	.260	6.60				
9455	9	Chart 1	.317	8.05				
9457	15	Chart 2R	.389	9.88	.015	.38	.035	.89

18 AWG • 19 x 30 • PVC/PVC

8489	4	Chart 1	.257	6.53	.017	.43	.032	.81
8465	5	Chart 1	.282	7.16	.017	.43	.033	.84
8467	7	Chart 1	.309	7.85	.017	.43	.037	.94
8469	9	Chart 1	.364	9.25	.017	.43		
8466	12	Chart 2R	.412	10.46	.017	.43	.040	1.02
8468	15	Chart 2R	.500	12.70	.017	.43		
8619	19	Chart 2R	.490	12.45	.017	.43	.045	.500
9626	25	Chart 2R	.612	15.54	.017	.43	.060	1.52

300 V, +80 °C • Unshielded



- Unjacketed
- AWM Style
- VW-1

Part No.	Conductors	Color Code	OD (Nom)		Insulation Thickness		Jacket Thickness	
			Inch	mm	Inch	mm	Inch	mm

16 AWG • PVC

Stranded (19 x 29) TC Conductors • PVC Insulation • Cabled								
9498	3	Orange, Black, Orange with Black Stripe	.243	6.17	.027	.69	-	-

BC = Bare Copper • TC = Tinned Copper • PVC = Polyvinyl Chloride | Belden Color Code Charts can be found at page 344.

Audio, Control and Instrumentation Cables

150 V, +80 °C • Unshielded



- UL AWM Style (Except 8442)

- NEC: CMG
- CEC: CMG FT4

Part No.	Conductors	Color Code	OD (Nom)		Insulation Thickness		Jacket Thickness	
			Inch	mm	Inch	mm	Inch	mm

22 AWG • PVC/PVC

Stranded (7 x 30) TC Conductors • PVC Insulation • Cabled • Chrome PVC Jacket									
8442	2	Black, Red	.170	4.32	.016	.41	0.25	.64	
8443	3	Black, Red, Green	.172	4.37					
8444	4	Chart 1	.185	4.70					
8445	5	Chart 1	.194	4.93					
9430	7	Chart 1	.214	5.44					
9421	8	Chart 1	.229	5.82	.011	.28	.032	.81	
9423	9	Chart 1	.244	6.20					
8456	10	Chart 1	.264	6.71					
8457	12	Chart 1	.272	6.91					
8458	15	Chart 1	.315	8.00					
9431	20	Chart 1	.345	8.76					
8459	25	Chart 1	.387	9.83	.011	.28	.040	1.02	
9432	30	Chart 1	.400	10.16					
9433	40	Chart 1	.455	11.56					
9434	50	Chart 1	.500	12.70	.011	.28	.045	1.14	

300 V, +60 °C • Foil Shield



Polyolefin/PVC

- AWM Style
- NEC: CM
- CEC: CM
- NEC: CL3 (8618)

Polyolefin/LSZH

- IEC 60332-3-24
- Smoke IEC6103

Part No.	Conductors	Color Code	OD (Nom)		Insulation Thickness		Jacket Thickness		Capacitance*	
			Inch	mm	Inch	mm	Inch	mm	pF/Ft	pF/m

Stranded TC Conductors • Polyolefin Insulation • Cabled • Overall Beldfoil® Shield • Stranded TC Drain Wire • Chrome PVC Jacket

22 AWG • 7 x 30 • 22 AWG Drain Wire • Polyolefin/PVC

8771	3	Black, White, Clear	.199	5.05	.017	.43	.033	.84	41	134
------	---	---------------------	------	------	------	-----	------	-----	----	-----

20 AWG • 7 x 28 • 22 AWG Drain Wire • Polyolefin/PVC

8772	3	Black, White, Clear	.218	5.54	.017	.43	.033	.84	51	167
------	---	---------------------	------	------	------	-----	------	-----	----	-----

18 AWG • 16 x 30 • 20 AWG Drain Wire • Polyolefin/PVC

8770	3	Black, White, Clear	.246	6.25	.018	.46	.033	.84	48	157
------	---	---------------------	------	------	------	-----	------	-----	----	-----

16 AWG • 19 x 29 • 18 AWG Drain Wire • Polyolefin/PVC

8618	3	Black, White, Clear	.327	8.3	.032	.81	.031	.79	50	164
------	---	---------------------	------	-----	------	-----	------	-----	----	-----

Stranded TC Conductors • Polyolefin Insulation • Cabled • Overall Beldfoil® Shielding • Stranded TC Drain Wire • Chrome LSZH Jacket

22 AWG • 7 x 30 • 22 AWG Drain Wire • Polyolefin/LSZH

8771NH	3	Black, White, Clear	.210	5.30	.015	.38	.035	.89	41	134
--------	---	---------------------	------	------	------	-----	------	-----	----	-----

20 AWG • 7 x 28 • 22 AWG Drain Wire • Polyolefin/LSZH

8772NH	3	Black, White, Clear	.220	5.65	.015	.38	.035	.89	41	134
--------	---	---------------------	------	------	------	-----	------	-----	----	-----

18 AWG • 16 x 30 • 20 AWG Drain Wire • Polyolefin/LSZH

8770NH	3	Black, White, Clear	.250	6.25	.015	.38	.035	.89	41	134
--------	---	---------------------	------	------	------	-----	------	-----	----	-----

* One conductor to other conductors connected to shield.

TC = Tinned Copper • PVC = Polyvinyl Chloride | Belden Color Code Charts can be found at page 344.

Audio, Control and Instrumentation Cables

300 V, +75 °C • Foil Shield

- AWM Style

- NEC: CM, CL3
- CEC: CM



Part No.	Conductors	Color Code	OD (Nom)		Insulation Thickness		Jacket Thickness		Capacitance*	
			Inch	mm	Inch	mm	Inch	mm	pF/Ft	pF/m

22 AWG • Polyolefin/PVC

Stranded (19 x 34) TC Conductors • Polyolefin Insulation • Cabled • Overall Beldfoil® Shield • Three 23 AWG and One 25 AWG Stranded TC Drain Wires • White PVC Jacket										
8729	4	Black, Red, Green, Clear	.257	6.53	.016	.41	.051	1.30	42	138

* One conductor to other conductors connected to shield.

300 V, +80 °C • Foil Shield

- AWM Style

- NEC: CMG
- CEC: CMG FT4



Part No.	Conductors	Color Code	OD (Nom)		Insulation Thickness		Jacket Thickness		Capacitance*	
			Inch	mm	Inch	mm	Inch	mm	pF/Ft	pF/m

18 AWG • SR-PVC/PVC

Stranded (19 x 30) TC Conductors • Semi-Rigid PVC Insulation • Cabled • Overall Beldfoil® Shield • 22 AWG Stranded TC Drain Wires • Chrome PVC Jacket										
9418	4	Red, Green, Black, White	.245	6.22	.010	.25	.035	.89	120	394

* One conductor to other conductors connected to shield.

300 V, +80 °C • Foil Shield

- AWM Style

- NEC: CMP
- CEC: CMP FT4



Part No.	Conductors	Color Code	OD (Nom)		Insulation Thickness		Jacket Thickness		Capacitance*	
			Inch	mm	Inch	mm	Inch	mm	pF/Ft	pF/m

18 AWG • FEP/Flamarrest

Stranded (19 x 30) • FEP Insulation • Cabled • Overall Beldfoil® Shield • 20 AWG TC Drain Wire • Natural Flamarrest Jacket										
82418	4	Black, White, Red, Green	.172	4.37	.007	.18	.015	.38	57	187

* One conductor to other conductors connected to shield.

300 V, +90 °C • Foil Shield

- NEC: CM
- CEC: CM



Part No.	Conductors	Color Code	OD (Nom)		Insulation Thickness		Jacket Thickness		Capacitance*	
			Inch	mm	Inch	mm	Inch	mm	pF/Ft	pF/m

22 AWG • Polyolefin/PVC

Stranded (7 x 30) TC Conductors • Polyolefin Insulation • Cabled • Overall Beldfoil® Shield • 22 AWG Stranded TC Drain Wire • Brown PVC Jacket										
9770	3	Black, Red, White	.145	3.68	.009	.23	.020	.51	60	197

* One conductor to other conductors connected to shield.

TC = Tinned Copper • FEP = Fluorinated Ethylene Propylene • PVC = Polyvinyl Chloride

Audio, Control and Instrumentation Cables

200 V, +105 °C • Braid Shield



Part No.	Conductors	Color Code	OD (Nom)		Insulation Thickness		Jacket Thickness		Capacitance*	
			Inch	mm	Inch	mm	Inch	mm	pF/Ft	pF/m

30 AWG • Polyolefin/PVC

Stranded (7 x 38) TC Conductors • Polyolefin Insulation • Cabled • Central Textile Strength Member • Paper Separator • 95% TC Braid Shielding • Chrome PVC Jacket										
8643	3	Black, Red, White	.096	2.44	.006	.15	.014	.36	43	141

* One conductor to other conductors connected to shield.

200 V, +105 °C • Braid Shield



Part No.	Conductors	Color Code	OD (Nom)		Insulation Thickness		Jacket Thickness		Capacitance*	
			Inch	mm	Inch	mm	Inch	mm	pF/Ft	pF/m

22 AWG • PVC/PVC

Stranded (7 x 38) TC Conductors • PVC Insulation • Cabled • 70% TC Braid Shielding • Chrome PVC Jacket										
8735	3	Black, Red, White	.202	5.13	.016	.41	.025	.64	60	197

* One conductor to other conductors connected to shield.

200 V, +80 °C • Braid Shield

• AWM Style

- NEC: CMG
- CEC: CMG FT4



Part No.	Conductors	Color Code	OD (Nom)		Insulation Thickness		Jacket Thickness		Capacitance*	
			Inch	mm	Inch	mm	Inch	mm	pF/Ft	pF/m

20 AWG • PVC/PVC

Stranded (7 x 30) TC Conductors • PVC Insulation • Cabled • 85% TC Braid Shielding • Chrome PVC Jacket										
9260	6	Chart 2R	.305	7.75	.017	.43	.032	.82	50	164
9261	12	Chart 2R	.396	10.06	.017	.43	.040	1.02	57	187

* One conductor to other conductors connected to shield.

Audio, Control and Instrumentation Cables

450 V, +80 °C • Spiral Shield



- AWM Style
- VW-1

Part No.	Conductors	Color Code	OD (Nom)		Insulation Thickness		Jacket Thickness		Capacitance*	
			Inch	mm	Inch	mm	Inch	mm	pF/Ft	pF/m

18 AWG • PVC/PVC

Stranded (7 x 26) TC Conductors • PVC Insulation • Cabled • 80% Spiral Wrap TC Shielding • Chrome PVC Jacket										
8791	3	Black, Red, White	.260	6.60	.022	.56	.028	.56	79	259

* One conductor to other conductors connected to shield.

300 V, +80 °C • Braid Shield/Unshielded



- AWM Style
- NEC: CM

Part No.	Conductors	Color Code	OD (Nom)		Insulation Thickness		Jacket Thickness	
			Inch	mm	Inch	mm	Inch	mm

22 AWG • PVC/PVC

Stranded (7 x 30) TC Conductors • PVC Insulation • Cabled • 80% TC Braid Shielding Over One Conductor • Chrome PVC Jacket										
8734	3 Total 1 Shielded 2 Unshielded	Black, Red, White	.194	4.93	.016	.41	.025	.64		

TC = Tinned Copper • PVC = Polyvinyl Chloride

Audio, Control and Instrumentation Cables

Plenum-Rated

300 V • Plenum • Unshielded



- Non-conduit
- Suitable for Outdoor and Direct Burial Applications
- NEC: CMP
- CEC: CMP FT6

Part No.	Conductors	Color Code	OD (Nom)		Insulation Thickness		Jacket Thickness	
			Inch	mm	Inch	mm	Inch	mm

Stranded TC Conductors • FEP Insulation • Cabled • Red FEP Jacket

22 AWG • 7 x 30 • FEP/FEP

88442	2	Black, Red	.102	2.59	.007	.18	.012	.30
88444	4	Black, White, Red, Green	.121	3.07	.007	.18	.010	.25

18 AWG • 19 x 30 • FEP/FEP

88489	4	Black, White, Red, Green	.161	4.09	.007	.18	.009	.23
-------	---	--------------------------	------	------	------	-----	------	-----

Stranded TC Conductors • FEP Insulation • Cabled • Natural Flamarrest® Jacket

22 AWG • 7 x 30 • FEP/Flamarrest

82442	2	Black, Red	.102	2.59	.006	.15	.015	.38
82444	4	Black, White, Red, Green	.121	3.07	.006	.15	.015	.38

18 AWG • 19 x 30 • FEP/Flamarrest

82489	4	Black, White, Red, Green	.170	4.32	.007	.18	.014	.36
-------	---	--------------------------	------	------	------	-----	------	-----

300 V • Plenum • Foil Shield



- Non-conduit
- Suitable for Outdoor and Direct Burial Applications
- NEC: CMP
- CEC: CMP FT6

Part No.	Conductors	Color Code	OD (Nom)		Insulation Thickness		Jacket Thickness		Capacitance*	
			Inch	mm	Inch	mm	Inch	mm	pF/Ft	pF/m

18 AWG • FEP/FEP

Stranded (19 x 30) TC Conductors • FEP Insulation • Overall Beldfoil® Shield • 20 AWG Stranded TC Drain Wires • Red FEP Jacket

88770	3	Black, White, Red	.155	3.94	.007	.18	.014	.36	96	315
89418	4	Black, White, Red, Green	.177	4.50	.007	.18	.014	.36	57	187

18 AWG • FEP/Flamarrest

Stranded (19 x 30) TC Conductors • FEP Insulation • Overall Beldfoil® Shield • 20 AWG Stranded TC Drain Wires • Natural Flamarrest Jacket

82418	4	Black, White, Red, Green	.176	4.47	.007	.18	.014	.36	63	207
-------	---	--------------------------	------	------	------	-----	------	-----	----	-----

* One conductor to other conductors connected to shield.

Audio, Control and Instrumentation Cables

Plenum-Rated

300 V • Plenum • Foil/Braid Shield



- Non-conduit
- Suitable for Outdoor and Direct Burial Applications
- -70 °C to +200 °C
- NEC: CMP
- CEC: CMP FT6

Part No.	Conductors	Color Code	OD (Nom)		Insulation Thickness		Jacket Thickness		Capacitance*	
			Inch	mm	Inch	mm	Inch	mm	pF/Ft	pF/m

Stranded TC Conductors • FEP Insulation • Cabled • Overall Beldfoil® + 85% TC Braid Shielding • Red FEP Jacket

24 AWG • 7 x 32 • FEP/FEP

83503	3	Chart 2	.135	3.43						
83504	4	Chart 2	.144	3.66						
83506	6	Chart 2	.165	4.19						
83509	9	Chart 2	.188	4.78	.006	.15	.014	.36	36	118
83512	12	Chart 2	.207	5.26						
83515	15	Chart 2	.227	5.77						

22 AWG • 7 x 30 • FEP/FEP

83552	2	Chart 2	.141	3.58						
83553	3	Chart 2	.148	3.76						
83554	4	Chart 2	.159	4.04	.006	.15	.014	.36		
83556	6	Chart 2	.183	4.65					40	132
83559	9	Chart 2	.209	5.31						
83562	12	Chart 2	.234	5.94	.006	.15	.015	.38		
83569	19	Chart 2	.269	6.83						

20 AWG • 7 x 28 • FEP/FEP

83602	2	Chart 2	.157	3.99						
83604	4	Chart 2	.178	4.52						
83606	6	Chart 2	.207	5.26	.006	.15	.014	.36	51	167
83609	9	Chart 2	.238	6.05						
83612	12	Chart 2	.265	6.73						

18 AWG • 19 x 30 • FEP/FEP

83652	2	Chart 2	.175	4.45						
83653	3	Chart 2	.184	4.67						
83654	4	Chart 2	.199	5.05	.007	.18	.014	.36		
83656	6	Chart 2	.234	5.94					60	197
83659	9	Chart 2	.293	7.44						
83662	12	Chart 2	.308	7.82	.007	.18	.015	.38		

16 AWG • 19 x 29 • FEP/FEP

83702	2	Chart 2	.196	4.98						
83703	3	Chart 2	.206	5.23						
83704	4	Chart 2	.223	5.66						
83706	6	Chart 2	.265	6.73						
83709	9	Chart 2	.307	7.80	.007	.18	.014	.36	63	207
83712	12	Chart 2	.344	8.74						
83715	15	Chart 2	.407	10.34						
83719	19	Chart 2	.403	10.24						

* One conductor to other conductors connected to shield.

TC = Tinned Copper • FEP = Fluorinated Ethylene Propylene | Belden Color Code Charts can be found at page 344.

High-Temperature Control and Instrumentation Cables

300 V, +150 °C • Unshielded

• VW-1



Part No.	Conductors	Color Code	OD (Nom)		Insulation Thickness		Jacket Thickness	
			Inch	mm	Inch	mm	Inch	mm

Stranded (7 x 28) TC Conductors • Cabled • ETFE Insulation • Clear ETFE Jacket

20 AWG • 7 x 28 • ETFE/ETFE

85220	2	Black, Red	.185	4.70	.015	.38	.020	.51
-------	---	------------	------	------	------	-----	------	-----

16 AWG • 19 x 29 • ETFE/ETFE

85221	2	Black, Red	.215	5.46	.014	.36	.020	.51
85102	2	Chart 2R	.211	5.36	.014	.36	.019	.48
85103	3	Chart 2R	.223	5.66	.014	.36		
85109	9	Chart 2R	.354	8.99	.014	.36	.024	.61

ETFE insulated and jacketed cables are particularly well suited for harsh environments due to outstanding mechanical toughness of the material, as well as its high-temperature and radiation resistant characteristics.

ETFE cables are used extensively in chemical plants, nuclear plants, and fossil fuel power plants. Typical applications are data recording, communication, telemetry, and monitoring pressure or material flow.

High-Temperature Control and Instrumentation Cables

600 V, +150 °C • Silicone Rubber • Foil Shield



- AWM Style
- -70 °C to +150 °C
- VW-1

- 2999 V DC Jacket Working Voltage (Shield to Ground)

Part No.	Conductors	Color Code	OD (Nom)		Insulation Thickness		Jacket Thickness		Capacitance*	
			Inch	mm	Inch	mm	Inch	mm	pF/Ft	pF/m

Stranded TC Conductors • FEP Insulation • Cabled • Noise-Reducing Tape • Overall Beldfoil® Shield • 22 AWG Stranded TC Drain Wire • Red Silicone Rubber Jacket

22 AWG • 7 x 30 • FEP/Silicone Rubber

83394	2	Black, White	.199	5.05	.015	.38	.030	.76	22	72
83395	3	Black, Red, White	.208	5.28	.015	.38	.031	.79	40	131
83396	4	Black, White, Red, Green	.217	5.51	.015	.38	.030	.76		

20 AWG • 7 x 28 • FEP/Silicone Rubber

83393	2	Black, Red	.242	6.15	.020	.51	.030	.76	22	72
-------	---	------------	------	------	------	-----	------	-----	----	----

* For 2-conductor cables, capacitance is measured conductor to conductor. For 3 conductors and higher, capacitance is measured as one conductor to other conductors connected to shield.

300 V, +150 °C • Foil Shield



- VW-1

Part No.	Conductors	Color Code	OD (Nom)		Insulation Thickness		Jacket Thickness		Capacitance*	
			Inch	mm	Inch	mm	Inch	mm	pF/Ft	pF/m

Stranded TC Conductors • ETFE Insulation • Cabled • Beldfoil® Shield • Stranded TC Drain Wire • Clear ETFE Jacket

20 AWG • 7 x 28 • ETFE/ETFE

85230	2	Black, Red	.182	4.62	.015	.38	.020	.51	31	102
85240	3	Black, Red, Green	.193	4.90	.015	.38	.020	.51	48	157

16 AWG • 19 x 29 • ETFE/ETFE

85231	2	Black, Red	.210	5.33	.014	.36	.020	.51	44	144
85241	3	Black, Red, Green	.223	5.66	.014	.36	.020	.51	48	157

* For 2-conductor cables, capacitance is measured conductor to conductor. For 3 conductors and higher, capacitance is measured as one conductor to other conductors connected to shield.

TC = Tinned Copper • ETFE = Ethylene/Tetrafluoroethylene • FEP = Fluorinated Ethylene Propylene

High-Temperature Control and Instrumentation Cables

MIL-W16878/4 (Type E) Conductors

600 V, +200 °C • TFE • Braid Shield

- -65 °C to +200 °C
- VW-1

- MIL-W16878/4 (Type E) Conductors



Part No.	Conductors	Color Code	OD (Nom)		Insulation Thickness		Jacket Thickness		Capacitance*	
			Inch	mm	Inch	mm	Inch	mm	pF/Ft	pF/m

Stranded Silver-Plated Conductors • Extruded TFE Insulation • Cabled • 85% Silver-Plated Braid Shielding • White Tape-Wrapped TFE Jacket

26 AWG • 7 x 34 • TFE/TFE

83303E	1	White	.076	1.93	.010	.25	.010	.25	44.6	146
83317E	2	White, Black	.121	3.07	.010	.25	.011	.28	35.5	116
83332E	3	White, Black, Red	.127	3.23	.010	.25	.011	.28	31.5	103
83347E	4	White, Black, Red, Green	.137	3.48	.010	.25	.011	.28	30.5	100

24 AWG • 19 x 36 • TFE/TFE

83304E	1	White	.085	2.16	.010	.25	.010	.25	46	151
83318E	2	White, Black	.131	3.33	.010	.25	.011	.28	42.4	139
83333E	3	White, Black, Red	.137	3.48	.010	.25	.011	.28	36.8	121
83348E	4	White, Black, Red, Green	.149	3.79	.010	.25	.011	.28	36.8	121

22 AWG • 19 x 34 • TFE/TFE

83305E	1	White	.091	2.31	.010	.25	.010	.25	57.9	190
83319E	2	White, Black	.143	3.63	.010	.25	.011	.28	49.2	161
83334E	3	White, Black, Red	.150	3.81	.010	.25	.011	.28	45.7	150
83349E	4	White, Black, Red, Green	.163	4.14	.010	.25	.011	.28	45.7	150

20 AWG • 19 x 32 • TFE/TFE

83306E	1	White	.099	2.52	.010	.25	.011	.25	69	226
83320E	2	White, Black	.159	4.04	.010	.25	.010	.28	51	167
83335E	3	White, Black, Red	.168	4.27	.010	.25	.010	.28	51	167
83350E	4	White, Black, Red, Green	.183	4.65	.011	.28	.011	.25	51	167

18 AWG • 19 x 30 • TFE/TFE

83307E	1	White	.109	2.77	.011	.28	.010	.25	71.5	135
83321E	2	White, Black	.179	4.55	.011	.28	.011	.28	52.8	173
83336E	3	White, Black, Red	.189	4.80	.010	.25	.011	.28	52.8	173
83351E	4	White, Black, Red, Green	.207	5.26	.010	.25	.011	.28	52.8	173

16 AWG • 19 x 29 • TFE/TFE

83308E	1	White	.120	3.05	.011	.28	.011	.28	72.5	238
83322E	2	White, Black	.197	5.00	.011	.28	.011	.28	60	197
83337E	3	White, Black, Red	.209	5.31	.011	.28	.011	.28	53	174
83352E	4	White, Black, Red, Green	.229	5.82	.011	.28	.011	.28	50.8	167

* One conductor to other conductors connected to shield.

TFE = Tetrafluoroethylene

Special Audio, Communication and Instrumentation Cables

300 V, +80 °C • Shielded • Triads

- VW-1

- NEC: CM
- NEC: Article 800
- CEC: CM

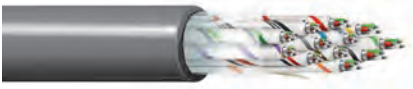

Part No.	Conductors	Color Code	OD (Nom)		Insulation Thickness		Jacket Thickness		Capacitance*	
			Inch	mm	Inch	mm	Inch	mm	pF/Ft	pF/m

22 AWG • Polyolefin/PVC

Stranded (7 x 30) TC Conductors • Polyolefin Insulation • White PVC Jacket Over Triads • Overall Beldfoil® Shield • 22 AWG TC Drain Wires • Overall Chrome PVC Jacket										
9772	36 (12 Triads)	Triads: Black, Red, Green	.725	18.42	.009	.23	.060	1.52	67	220

* One conductor to other conductors connected to shield.

350 V, +80 °C • Foil Shielded Quads • Unshielded Conductors

- VW-1



Part No.	Conductors	Color Code	OD (Nom)		Insulation Thickness		Jacket Thickness	
			Inch	mm	Inch	mm	Inch	mm

24 AWG and 22 AWG • Polyolefin/PVC

Stranded (7 x 32 and 7 x 30) TC Conductors • Polyolefin Insulation (24 AWG), PVC Insulation (22 AWG) • Green Beldfoil® Shield on One Quad, Red Beldfoil® Shield on One Quad • 24 AWG Stranded TC Drain Wire • Chrome PVC Jacket										
8787	10 Total 8 (24 AWG Shielded: 2 Quads) 2 (22 AWG Unshielded)	Quad 1: Gray, White, Green, Blue Quad 2: Brown, Red, Yellow, Orange Unshielded: Blue, White	.290	7.87	.012	.30	.030	.76		
					.016	.41				

TC = Tinned Copper • PVC = Polyvinyl Chloride

Special Audio, Communication and Instrumentation Cables

300 V, +60 °C • Foil Shielded and Unshielded

• VW-1

• NEC: CM

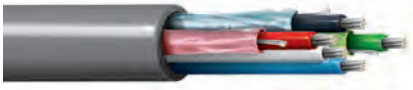

Part No.	Conductors	Color Code	OD (Nom)		Insulation Thickness		Jacket Thickness	
			Inch	mm	Inch	mm	Inch	mm

22 AWG • PVC/PVC

Stranded (7 x 30) TC Conductors • PVC Insulation • Individually Beldfoil® Shielded Conductors • Tinned Cadmium Bronze Ribbon Drain Wire • Chrome PVC Jacket

8788	5 Total 3 Shielded 2 Unshielded	Shielded: Black, Red, Green Unshielded: Yellow, Blue	.236	5.99	.016	.41	.028	.71
-------------	---------------------------------------	--	------	------	------	-----	------	-----

300 V, +90 °C • Foil Shielded and Unshielded

- NEC: CM
- NEC: Article 800
- CEC: CM



Part No.	Conductors	Color Code	OD (Nom)		Insulation Thickness		Jacket Thickness	
			Inch	mm	Inch	mm	Inch	mm

24 AWG and 22 AWG • PVC/PVC

Stranded (7 x 32 and 7 x 30) TC Conductors • PVC Insulation • Beldfoil® Shield • 22 AWG Stranded TC Drain Wire • Chrome PVC Jacket

8786	6 Total 4 (24 AWG Shielded) 2 (22 AWG Unshielded)	Shielded: Black, Green, Red, Yellow Unshielded: White, Blue	.236	5.99	.016	.41	.028	.71
-------------	---	--	------	------	------	-----	------	-----

TC = Tinned Copper • PVC = Polyvinyl Chloride

Fire Alarm Power-Limited Fire Protective Signaling Circuit Cables

Subject 1424 (NEC Article 760, Type FPLR)

300 V, +105 °C • Unshielded

- AWM Style

- NEC: MPR, FPLR
- CEC: FAS 105 FT4



Part No.	Conductors	Color Code	OD (Nom)		Insulation Thickness		Jacket Thickness	
			Inch	mm	Inch	mm	Inch	mm

22 AWG • PVC/PVC

Solid TC Conductors • PVC Insulation • Cabled • Black PVC Jacket								
9576	6	Black, White, Red, Green, Brown, Blue	.234	5.94	.013	.33	.039	.99

300 V, +105 °C • Unshielded

- AWM Style

- NEC: MPR, FPLR
- CEC: FAS 105 FT4



Part No.	Conductors	Color Code	OD (Nom)		Insulation Thickness		Jacket Thickness	
			Inch	mm	Inch	mm	Inch	mm

Solid BC Conductors • PVC Insulation • Cabled • Red PVC Jacket								
--	--	--	--	--	--	--	--	--

18 AWG • PVC/PVC

9571	2	Black, Red	.228	5.79	.017	.43	.037	.94
------	---	------------	------	------	------	-----	------	-----

16 AWG • PVC/PVC

9572	2	Black, Red	.238	6.05	0.16	.41	.036	.91
------	---	------------	------	------	------	-----	------	-----

14 AWG • PVC/PVC

9580	2	Black, Red	.303	7.70	.022	.56	.042	1.07
------	---	------------	------	------	------	-----	------	------

12 AWG • PVC/PVC

9582	2	Black, Red	.340	8.64	.022	.56	.042	1.07
------	---	------------	------	------	------	-----	------	------

BC = Bare Copper • TC = Tinned Copper • PVC = Polyvinyl Chloride

Fire Alarm Power-Limited Fire Protective Signaling Circuit Cables

Subject 1424 (NEC Article 760, Type FPLR)

300 V, +105 °C • Foil Shielded

- AWM Style

- NEC: MPR, FPLR
- CEC: FAS 105 FT4



Part No.	Conductors	Color Code	OD (Nom)		Insulation Thickness		Jacket Thickness	
			Inch	mm	Inch	mm	Inch	mm

Solid BC Conductors • PVC Insulation • Cabled • Overall Beldfoil® Shield • Red PVC Jacket

18 AWG • PVC/PVC

9574	2	Black, Red	.231	.587	.017	.43	.037	.94
9578	4	Black, Red, Yellow, Light Blue	.263	6.68				

16 AWG • PVC/PVC

9575	2	Black, Red	.241	6.12	.016	.41	.036	.91
9579	4	Black, Red, Yellow, Light Blue	.301	7.65	.018	.46	.042	1.07

14 AWG • PVC/PVC

9581	2	Black, Red	.306	7.77	.022	.56	.042	1.07
------	---	------------	------	------	------	-----	------	------

12 AWG • PVC/PVC

9583	2	Black, Red	.343	8.71	.022	.56	.042	1.07
------	---	------------	------	------	------	-----	------	------

BC = Bare Copper • PVC = Polyvinyl Chloride

**Plenum-Rated Fire Alarm Power-Limited
Fire Protective Control and Instrumentation Cables**
Subject 1424 (NEC Article 760, Type FPLR)

300 V, +200 °C • Foil/Braid Shield •
Plenum

• AWM Style

- NEC: FPLR, CMP
- CEC: CMP FT6



Part No.	Conductors	Color Code	OD (Nom)		Insulation Thickness		Jacket Thickness	
			Inch	mm	Inch	mm	Inch	mm

Stranded TC Conductors • FEP Insulation • Cabled • Overall Beldfoil® + 85% TC Braid Shielding • Red FEP Jacket

14 AWG • 7 x 22 • FEP/FEP

83752	2	Black, White	.267	6.78				
83753	3	Black, White, Red	.284	7.21	.016	.41	.015	.38
83754	4	Black, White, Red, Green	.311	7.90				
83756	6	Black, White, Red, Green, Orange, Blue	.376	9.55	.016	.41	.017	.43

12 AWG • 7 x 20 • FEP/FEP

83802	2	Black, White	.303	7.70				
83803	3	Black, White, Red	.323	8.20	.016	.41	.015	.38
83804	4	Black, White, Red, Green	.359	9.12				
83806	6	Black, White, Red, Green, Orange, Blue	.430	10.92	.016	.41	.017	.43

TC = Tinned Copper • FEP = Fluorinated Ethylene Propylene

Circuit Integrity (CI) SAFE-T-Line® Cables

Commercial Application, Addressable Systems

300 V, +105 °C • Unshielded



- Riser Rated
 - BS 6387 CWZ (3 hours)
 - EN 50200: PH 120 (2 hours)
 - IEC 60754-1/2 & EN 50267-2-1/2
- NEC: FPLR

Part No.	Conductors	Color Code	OD (Nom)		Insulation Thickness		Jacket Thickness		Capacitance (Nom)*	
			Inch	mm	Inch	mm	Inch	mm	pF/Ft	pF/m

Solid BC Conductors • Ceramifiable Silicone Rubber Insulation • Red Flame-Retardant Polyethylene Jacket

18 AWG • Silicone Rubber/FR-Polyethylene

5320UME	2	Black, Red	.31	7.87						
5322UME	4	Black, Numbered	.35	8.89	.045	1.14	.034	.86	17	56
5324UME	6	Black, Numbered	.42	10.67						
5326UME	8	Black, Numbered	.45	11.43						

16 AWG • Silicone Rubber/FR-Polyethylene

5220UME	2	Black, Red	.33	8.38	.045	1.14	.034	.86	19	62
5222UME	4	Black, Numbered	.38	9.65						

14 AWG • Silicone Rubber/FR-Polyethylene

5120UME	2	Black, Red	.36	9.14	.045	1.14	.034	.86	21	69
5122UME	4	Black, Numbered	.41	10.41						

12 AWG • Silicone Rubber/FR-Polyethylene

5020UME	2	Black, Red	.39	9.91	.045	1.14	.034	.86	23	75
5022UME	4	Black, Numbered	.45	11.43						

* For 2-conductor cables, capacitance is measured conductor to conductor. For 3 conductors and higher, capacitance is measured as one conductor to other conductors.

Circuit Integrity (CI) SAFE-T-Line® Cables
Commercial Application, Addressable Systems

300 V, +105 °C • Foil Shielded

- Riser Rated
- BS 6387 CWZ (3 hours)
- EN 50200: PH 120 (2 hours)
- IEC 60754-1/2 & EN 50267-2-1/2
- NEC: FPLR

Part No.	Conductors	Color Code	OD (Nom)		Insulation Thickness		Jacket Thickness		Capacitance (Nom)*	
			Inch	mm	Inch	mm	Inch	mm	pF/Ft	pF/m



18 AWG • Solid • Silicone Rubber/FR-Polyethylene

Solid or Stranded BC Conductors • Ceramifiable Silicone Rubber Insulation • Overall Beldfoil® Shield • Red Flame-Retardant Polyethylene Jacket										
5320FME	2	Black, Red	.31	7.87						
5322FME	4	Black, Numbered	.36	9.14	.045	1.14	.034	.86	27	89
5324FME	6	Black, Numbered	.42	10.67						
5326FME	8	Black, Numbered	.46	11.61						



18 AWG • 7 x 26 • Silicone Rubber/FR-Polyethylene

Solid or Stranded BC Conductors • Ceramifiable Silicone Rubber Insulation • Overall Beldfoil® Shield • Red Flame-Retardant Polyethylene Jacket										
5300FME	2	Black, Red	.32	8.13						
5302FME	4	Black, Numbered	.37	9.40	.045	1.14	.034	.86	27	89
5304FME	6	Black, Numbered	.44	11.18						
5306FME	8	Black, Numbered	.47	11.94						



16 AWG • Solid • Silicone Rubber/FR-Polyethylene

Solid or Stranded BC Conductors • Ceramifiable Silicone Rubber Insulation • Overall Beldfoil® Shield • Red Flame-Retardant Polyethylene Jacket										
5220FME	2	Black, Red	.33	8.38	.045	1.14	.034	.86	31	102
5222FME	4	Black, Numbered	.38	9.65						



16 AWG • 7 x 24 • Silicone Rubber/FR-Polyethylene

Solid or Stranded BC Conductors • Ceramifiable Silicone Rubber Insulation • Overall Beldfoil® Shield • Red Flame-Retardant Polyethylene Jacket										
5200FME	2	Black, Red	.35	8.89	.045	1.14	.034	.86	31	102
5202FME	4	Black, Numbered	.40	10.16						

* For 2-conductor cables, capacitance is measured conductor to conductor. For 3 conductors and higher, capacitance is measured as one conductor to other conductors connected to shield.

BC = Bare Copper

Circuit Integrity (CI) SAFE-T-Line® Cables

Commercial Application, Addressable Systems

300 V, +105 °C • Foil Shielded

- Riser Rated
- BS 6387 CWZ (3 hours)
- EN 50200: PH 120 (2 hours)
- IEC 60754-1/2 & EN 50267-2-1/2
- NEC: FPLR

Part No.	Conductors	Color Code	OD (Nom)		Insulation Thickness		Jacket Thickness		Capacitance (Nom)*	
			Inch	mm	Inch	mm	Inch	mm	pF/Ft	pF/m



14 AWG • Solid • Silicone Rubber/FR-Polyethylene

Solid or Stranded BC Conductors • Ceramifiable Silicone Rubber Insulation • Overall Beldfoil® Shield • Red Flame-Retardant Polyethylene Jacket										
5120FME	2	Black, Red	.36	9.14	.045	1.14	.034	.86	33	108
5122FME	4	Black, Numbered	.41	10.41						



14 AWG • 7 x 22 • Silicone Rubber/FR-Polyethylene

Solid or Stranded BC Conductors • Ceramifiable Silicone Rubber Insulation • Overall Beldfoil® Shield • Red Flame-Retardant Polyethylene Jacket										
5100FME	2	Black, Red	.38	9.65	.045	1.14	.034	.86	33	108
5102FME	4	Black, Numbered	.44	11.18						



12 AWG • Solid • Silicone Rubber/FR-Polyethylene

Solid or Stranded BC Conductors • Ceramifiable Silicone Rubber Insulation • Overall Beldfoil® Shield • Red Flame-Retardant Polyethylene Jacket										
5020FME	2	Black, Red	.39	9.91	.045	1.14	.034	.86	37	121
5022FME	4	Black, Numbered	.46	11.68						



12 AWG • 7 x 20 • Silicone Rubber/FR-Polyethylene

Solid or Stranded BC Conductors • Ceramifiable Silicone Rubber Insulation • Overall Beldfoil® Shield • Red Flame-Retardant Polyethylene Jacket										
5000FME	2	Black, Red	.42	10.67	.045	1.14	.034	.86	40	131
5002FME	4	Black, Numbered	.48	12.19						

* For 2-conductor cables, capacitance is measured conductor to conductor. For 3 conductors and higher, capacitance is measured as one conductor to other conductors connected to shield.

Circuit Integrity (CI) SAFE-T-Line® Cables

Commercial Application, Addressable Systems

300 V, +105 °C • Foil Shielded



- Riser Rated
- BS 6387 CWZ (3 hours)
- EN 50200: PH 120 (2 hours)
- IEC 60754-1/2 & EN 50267-2-1/2
- NEC: PLTC, FPLR

Part No.	Conductors	Stranding	Color Code	OD (Nom)		Insulation Thickness		Jacket Thickness		Capacitance (Nom)*	
				Inch	mm	Inch	mm	Inch	mm	pF/Ft	pF/m

14 AWG • Solid • Silicone Rubber/FR-Polyethylene

Solid or Stranded BC Conductors • Ceramifiable Silicone Rubber Insulation • Overall Beldfoil® Shield • Red Flame-Retardant Polyethylene Jacket											
5240FRE	2	7 x 24	Black, White	.35	8.89	.034	.86	.364	1.10	31	102
5201FRE	3	7 x 24	Red, White	.37	9.40						

* For 2-conductor cables, capacitance is measured conductor to conductor. For 3 conductors and higher, capacitance is measured as one conductor to other conductors connected to shield.

BC = Bare Copper

Computer, Instrumentation and Medical Electronics Cables

Data Cables AMP SDL Connectors

350 V, +80 °C • Foil Shield

- Direct Burial

- NEC:CL2X



Part No.	Conductors	Color Code	OD (Nom)		Insulation Thickness		Jacket Thickness		Capacitance*	
			Inch	mm	Inch	mm	Inch	mm	pF/Ft	pF/m

20 AWG • Polyolefin/Polyethylene

Solid TC Conductors • Polyolefin Insulation • Cabled • Overall Beldfoil® Shield • 22 AWG Solid TC Drain Wire • Black High-Density Polyethylene Jacket										
9802	2	Chart 1	.190	4.83	.013	.33	.035	.89		
9803	3	Chart 1	.205	5.21	.013	.33	.035	.89	42	138
9890	10	Chart 1	.310	7.87	.013	.33	.040	1.02		
9894	15	Chart 2R	.390	9.91	.013	.38	.045	1.14		

* One conductor to other conductors connected to shield.

300 V, +80 °C • Shielded

- AWM Style
- VW-1

- NEC: CL2X



Part No.	Conductors	Color Code	OD (Nom)		Insulation Thickness		Jacket Thickness	
			Inch	mm	Inch	mm	Inch	mm

26 AWG • PVC/PVC

Stranded (7 x 34) TC Conductors • PVC Insulation • Overall Duofoil® Shielding • 26 AWG Stranded TC Drain Wire • Black PVC Jacket										
1211A	4	White, Yellow, Orange, Green	.195	4.95	.015	.38	.036	.91		
1212A	6	Red, Blue, Green, Blue, Yellow, Orange, White	.220	5.59	.015	.38	.037	.93		
1213A	8	Black, Purple, Red, Blue, Green, Blue, Orange, Yellow, White	.239	6.07	.015	.38	.039	.98		
1214A	66	White/Red, White/Brown, White/Black, Black, Red, Brown, Purple, Blue, Green, Gray, Aqua, Tan, Pink, Orange, White, Yellow	.301	7.65	.015	.38	.035	.89		

TC = Tinned Copper • PVC = Polyvinyl Chloride | Belden Color Code Charts can be found at page 344.

MIL-W-16878 (Type B) Conductors

600 V, +105 °C • Braid Shield

• VW-1

• MIL-W-16878 (Type B) Conductors



Part No.	Conductors	Color Code	OD (Nom)		Insulation Thickness		Jacket Thickness		Capacitance*	
			Inch	mm	Inch	mm	Inch	mm	pF/Ft	pF/m

Stranded TC Conductors • PVC Insulation • Clear Nylon Skin Over Insulation • Cabled • 90% TC Braid Shielding • PVC Jacket

22 AWG • 19 x 34 • PVC-Nylon/PVC

9965	1	White	.100	2.54	.010/.003	.25/.08	.010	.25	100	328
9966	2	White, Black	.176	4.47	.010/.003	.25/.08	.020	.51	87	285
9967	3	White, Black, Red	.184	4.67	.010/.003	.25/.08	.020	.51	88	289
9968	4	White, Black, Red, Green	.200	5.08	.010/.003	.25/.08	.020	.51	69	226

20 AWG • 19 x 32 • PVC-Nylon/PVC

9961	1	White	.109	2.77	.011/.003	.27/.08	.010	.25	103	388
9962	2	White, Black	.192	4.88	.011/.003	.27/.08	.020	.51	91	299
9963	3	White, Black, Red	.210	5.33	.011/.003	.27/.08	.025	.64	84	276
9964	4	White, Black, Red, Green	.226	5.74	.011/.003	.27/.08	.025	.64	100	328

16 AWG • 19 x 29 • PVC-Nylon/PVC

9951	1	White	.143	3.63	.012/.003	.30/.08	.016	.41	138	453
9952	2	White, Black	.250	6.35	.012/.003	.30/.08	.025	.64	95	312
9953	3	White, Black, Red	.264	6.71	.012/.003	.30/.08	.027	.69	101	331
9954	4	White, Black, Red, Green	.291	7.39	.012/.003	.30/.08	.027	.69	94	308

* One conductor to other conductors connected to shield.

TC = Tinned Copper • PVC = Polyvinyl Chloride

Security Systems and Duplex Primary Wire

Security/Audio/Power-Limited Control Cable • 200 V, +75 °C • Unshielded

• VW-1



Part No.	Conductors	Color Code	OD (Nom)		Insulation Thickness		Jacket Thickness	
			Inch	mm	Inch	mm	Inch	mm

20 AWG • PVC/PVC

Stranded (7 x 28) BC Conductors • PVC Insulation • Parallel • Chrome PVC Jacket								
8484	4	Black, Green, Red, White	.173	4.39	.010	.25	.020	.51

Duplex Primary Wire • 300 V, +75 °C • Nonplenum • Unshielded

• VW-1



Part No.	Conductors	Color Code	OD (Nom)		Insulation Thickness		Jacket Thickness	
			Inch	mm	Inch	mm	Inch	mm

Stranded BC Conductors • PVC Insulation • Parallel • Chrome PVC Jacket								
--	--	--	--	--	--	--	--	--

16 AWG • 19 x 29 • PVC/PVC

8677	2	Brown, Red	.149 x .254	3.78 x 6.45	.024	.61	.022	.56
------	---	------------	-------------	-------------	------	-----	------	-----

14 AWG • 19 x 27 • PVC/PVC

8675	2	Brown, Red	.168 x .290	4.27 x 7.37	.023	.58	.023	.58
------	---	------------	-------------	-------------	------	-----	------	-----

12 AWG • 19 x 25 • PVC/PVC

8673	2	Brown, Red	.186 x 3.28	4.72 x 8.33	.026	.66	.022	.56
------	---	------------	-------------	-------------	------	-----	------	-----

10 AWG • 19 x 23 • PVC/PVC

8678	2	Brown, Red	.225 x .400	5.72 x 10.16	.032	.81	.025	.64
------	---	------------	-------------	--------------	------	-----	------	-----

Antenna Rotor Cables

300 V, +80 °C • Unshielded



- AWM Style
- VW-1
- NEC: CM

Part No.	Conductors	Color Code	OD (Nom)		Insulation Thickness		Jacket Thickness	
			Inch	mm	Inch	mm	Inch	mm

18 and 16 AWG • PVC/PVC

Stranded (16 x 30 and 19 x 28) TC Conductors • PVC Insulation • Cabled • Chrome PVC Jacket								
9405	6 (18 AWG)	Brown, Red, Yellow, Blue, Orange, Green	.345	8.76	.019	.48	.032	.81
	2 (16 AWG)	Black, White						

150 V, +80 °C • Unshielded

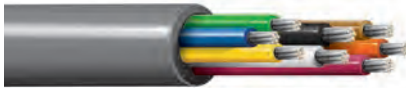

- AWM Style
- NEC: CMG
- CEC: CMG FT4

Part No.	Conductors	Color Code	OD (Nom)		Insulation Thickness		Jacket Thickness	
			Inch	mm	Inch	mm	Inch	mm

22 and 18 AWG • PVC/PVC

Stranded (7 x 30 and 16 x 30) TC Conductors • PVC Insulation • Cabled • Chrome PVC Jacket								
8446	4 (22 AWG)	Red, Green, Brown, Blue	.236	5.99	.011	.28	.032	.81
	2 (18 AWG)	Black, White						
8448	6 (22 AWG)	Brown, Red, Yellow, Blue, Orange, Green	.259	6.58	.011	.28	.032	.81
	2 (18 AWG)	Black, White						

Rubber SO Power and Control Cables

600 V, +60 °C • Unshielded



- Oil Res
- UL: SO
- CSA: SO
- CSA: FT2

Part No.	Conductors	Color Code	OD (Nom)		Insulation Thickness		Jacket Thickness	
			Inch	mm	Inch	mm	Inch	mm

16 AWG • EPDM/Rubber

Stranded (65 x 34) BC Conductors • EPDM Insulation • Cabled • Paper Tape Separator • Fillers Added • Black Rubber Jacket								
9420	5	Chart 2	.506	12.85	.033	8.38	.084	2.13
9422	7	Chart 2	.581	14.76	.033	8.38	0.83	2.11
9424	9	Chart 2	.720	18.29	.033	8.38	.100	2.54
9425	12	Chart 2	.720	18.29				
9427	16	Chart 2	.787	19.99				
9429	20	Chart 2	.862	21.29				

TC = Tinned Copper • PVC = Polyvinyl Chloride • BC = Bare Copper • EPDM = Ethylene-Propylene Diene Elastomer | Belden Color Code Charts can be found at page 344.

MachFlex Flexible Control Cables

Overview and Application Guide

Belden MachFlex is a complete line of control, data, video, and power cables specifically designed to handle the rigorous speeds and near-constant motion encountered in automated equipment such as robots, pick and place machines, automatic handling systems, multi-axis machine tools, and conveyor systems.

When the application demands highly flexible cables offering exceptional cable life and performance, specify Belden MachFlex.

Belden MachFlex Means More Performance and Longer Life

Reduced Cable Memory – Belden MachFlex's unique design and neutralized cabling results in cables that are relaxed, with almost no memory.

Greater Flex Life – Belden MachFlex cables offer superior flexibility and are able to handle the vigorous motions and high speeds encountered in automated equipment.

Greater System Uptime – Belden MachFlex cables combine specialized manufacturing techniques with precision copper stranding and rugged insulation and jacketing compounds to maximize flex life and reliability.

No Talc Problems – Unlike the potentially harmful talc used in other cables, Belden's non-toxic, non-irritating slipper compound facilitates flexing and also complies with OSHA regulations. It's safer for employees and operators and is less likely to contaminate solder joints or mechanical compounds.

CE Conformity – All Belden MachFlex cables are CE marked per the Conformité Européenne low voltage directive, allowing trade of product in Europe.

Custom Conductor Counts – Available upon request.

Product Series Descriptions

- **600 V MachFlex Super 360TC for Extreme Flexing (10 Million Flex Cycles), C-TC+** – The C-TC+ series is designed for C-track and extreme flex applications up to 10 million flex cycles*. This series utilizes super fine stranding and some of the tightest lay lengths allowed by UL, providing outstanding flex life. *(at pages 42–43)*
- **600 V MachFlex 360TC for Moderate Flexing (1 Million Flex Cycles), FCC** – The FCC series is a cost-effective alternative for C-track and moderate flexing applications rated up to 1 million flex cycles. *(at pages 44–46)*
- **300 V MachFlex Data Cables (1 Million Flex Cycles), Flex Data Cables** – Belden MachFlex Data cables are designed for industrial applications where precise data transmission is combined with high-flexing. These cables are ideal for effective operation of computer controlled equipment or other automated production processes, even in harsh environments. *(at page 249)*
- **MachFlex Vision 75 Ohm Coax Cables (1 Million Flex Cycles), Flex Vision** – Belden MachFlex Vision cables are continuous flex video cables designed for machine vision applications. They are ideal for motion-controlled video and with inspection and measurement equipment. *(at page 249)*

* Based on proper installation techniques in a C-track cable guide.

Application Guide

Belden MachFlex Series	C-Track Systems	Multi-Axis Machining	Robotics	Auto-mated Assembly Systems	Material Handling Systems	Pick & Place Systems	Auto-mated Storage Retrieval	Gantry Systems	Machine Vision	Motion-Controlled Video	Inspection & Measure Equip.	Fes-tooning	Servo	Power	Wind
FCC Oil & abrasion resistant 600 V UL & CSA rated Life Expectancy: Over 1 million flex cycles*	●	●		●	●	●	●	●			●	●	●	●	●
C-TC+ Oil & abrasion resistant 600 V UL & CSA rated Life Expectancy: Over 10 million flex cycles*	★	★	●	★	★	★	★	★			★	★	★	★	★
DATA Oil & abrasion resistant 300 V UL & CSA rated Life Expectancy: Over 1 million flex cycles*	●	●		●	●	●	●	●			●	●			
VISION 30 V UL & CSA rated Life Expectancy: Over 1 million flex cycles*	●	●		●	●	●	●	●	★	+	+	●			
● Good + Better ★ Best															

* Based on proper installation techniques in a C-track cable guide.

MachFlex Flexible Control Cables

600 V MachFlex Super 360TC for Extreme Flexing (10 Million Flex Cycles)

C-TC+ Control Cables • Unshielded



- UL AWM 2587 (600 V, +90 °C)
- CSA AWM I/II A/B 600 V +105 °C
- Sunlight Res
- Oil Res I/II
- UL Direct Burial
- IEEE 1202/383 FT4
- -40 °C to +90 °C (Cold Impact)
- -5 °C to +90 °C (Flexing)

Part No.	Conductors		Pull Tension (Max)		OD (Nom)		Insulation Thickness		Jacket Thickness		Additional Features/Ratings
	Circuit	Ground (Grn/Yel)	Lbs	N	Inch	mm	Inch	mm	Inch	mm	

Stranded BC Conductors • PVC Insulation • Abrasion Resistant Orange Belflex® TPE Jacket

20 AWG • 74 x 38

7101W	2	1	45	200	.237	6.02					
7102W	3	1	59	262	.256	6.50	.015	.38	.037	.94	
7105W	8	1	130	578	.376	9.55	.015	.38	.042	1.07	UL PLTC
7106W	11	1	178	792	.417	10.59					
7107W	17	1	260	1156	.480	12.19	.015	.38	.053	1.35	
7108W	24	1	370	1645	.563	14.30					

Stranded BC Conductors • PVC/Nylon Insulation • Abrasion Resistant Orange Belflex® TPE Jacket

18 AWG • 114 x 38

7110W	2	1	69	307	.289	7.34					
7111W	3	1	92	409	.313	7.95	.020	.51	.047	1.19	
7113W	6	1	161	716	.390	9.91					
7116W	17	1	400	1779	.576	14.63	.020	.51	.063	1.60	
7117W	24	1	575	2558	.678	17.22					

16 AWG • 190 x 38

7122W	2	1	114	507	.333	8.46	.020	.51	.047	1.19	UL AWM 21486 (1000 V, +90 °C) UL TC-ER UL WTTC 1000 V C(UL) Type TC & CIC FT4
7125W	6	1	266	1183	.460	11.68					
7126W	8	1	342	1521	.561	14.25					
7127W	11	1	456	2028	.582	14.78	.020	.51	.063	1.60	
7129W	24	1	950	4226	.800	20.32					

12 AWG • 413 x 38

7145W	3	1	330	1468	.446	11.33	.020	.51	.047	1.19	
-------	---	---	-----	------	------	-------	------	-----	------	------	--

Conductor Color Coding: Black, Numbered, Green/Yellow Ground

MachFlex Flexible Control Cables

600 V MachFlex Super 360TC for Extreme Flexing (10 Million Flex Cycles)

C-TC+ Control Cables • Braid Shielded • Double Jacketed



- UL AWM 2587 (600 V, +90 °C)
- CSA AWM I/II A/B 600 V +105 °C
- Sunlight Res
- Oil Res. I/II
- UL Direct Burial
- IEEE 1202/383 FT4
- -40 °C to +90 °C (Cold Impact)
- -5 °C to +90 °C (Flexing)

Part No.	Conductors		Pull Tension (Max)		OD (Nom)		Insulation Thickness		Inner Jacket Thickness		Outer Jacket Thickness		Additional Features/Ratings
	Circuit	Ground (Grn/Yel)	Lbs	N	Inch	mm	Inch	mm	Inch	mm	Inch	mm	

Stranded BC Conductors • PVC Insulation • TPE Inner Jacket • 85% TC Braid Shield • Abrasion Resistant Orange Belflex® TPE Jacket

20 AWG • 74 x 38

7106WS	11	1	194	863	.489	12.42	.015	.38	.025	.64	.053	1.35	UL PLTC
---------------	----	---	-----	-----	------	-------	------	-----	------	-----	------	------	---------

Stranded BC Conductors • PVC/Nylon Insulation • TPE Inner Jacket • 85% TC Braid Shield • Abrasion Resistant Orange Belflex® TPE Jacket

18 AWG Stranded • 114 x 38

7111WS	3	1	92	409	.391	9.93	.021	.53	.025	.64	.047	1.19	
---------------	---	---	----	-----	------	------	------	-----	------	-----	------	------	--

16 AWG Stranded • 190 x 38

7123WS	3	1	152	676	.435	11.05	.021	.53	.025	.64	.047	1.19	UL AWM 21486 (1000 V, +90 °C) UL TC-ER UL WTTC 1000 V C(UL) Type TC & CIC FT4
7129WS	24	1	950	4226	.918	23.32	.021	.53	0.63	1.60	.083	2.11	

14 AWG Stranded • 266 x 38

7136WS	3	1	208	925	.488	12.40	.021	.53	.030	.76	.053	1.35	
---------------	---	---	-----	-----	------	-------	------	-----	------	-----	------	------	--

Conductor Color Coding: Black, Numbered, Green/Yellow Ground.

BC = Bare Copper • TC = Tinned Copper • PVC = Polyvinyl Chloride

MachFlex Flexible Control Cables

600 V MachFlex 360TC for Moderate Flexing (1 Million Flex Cycles)

FCC Control Cable • Unshielded



- UL AWM 2587 (600 V, +90 °C)
- CSA AWM I/II A/B 600 V +105 °C
- Sunlight Res
- Oil Res I/II
- UL Direct Burial
- IEEE 1202/383 FT4
- -40 °C to +90 °C (Cold Impact)
- -5 °C to +90 °C (Flexing)

Part No.	Conductors		Pull Tension (Max)		OD (Nom)		Insulation Thickness		Jacket Thickness		Additional Features/Ratings
	Circuit	Ground (Grn/Yel)	Lbs	N	Inch	mm	Inch	mm	Inch	mm	

Stranded BC Conductors • PVC Insulation • Abrasion Resistant Chrome Belflex® TPE Jacket

20 AWG • 10 x 30

7400W	2	—	26	116	.211	5.36					
7401W	2	1	39	173	.221	5.61					
7402W	3	1	52	231	.238	6.05	.015	.38	.037	.94	
7403W	4	1	65	289	.257	6.53					
7404W	6	1	91	405	.309	7.85					UL PLTC
7405W	8	1	117	520	.345	8.76	.015	.38	.042	1.07	
7406W	11	1	156	693	.363	9.22					
7407W	17	1	234	1041	.441	11.20					
7408W	24	1	325	1445	.517	13.13	.015	.38	.053	1.35	

Stranded BC Conductors • PVC/Nylon Insulation • Abrasion Resistant Chrome Belflex® TPE Jacket

18 AWG • 16 x 30

7409W	2	—	50	222	.264	6.71	.022	.56	.040	1.02	
7410W	2	1	69	307	.289	7.34					
7411W	3	1	92	409	.313	7.95					
7412W	4	1	115	511	.339	8.61	.020	.51	.047	1.19	
7413W	6	1	161	716	.390	9.91					
7414W	8	1	252	1121	.451	11.46					
7415W	11	1	276	1227	.468	11.89					
7416W	17	1	414	1841	.576	14.63					
7417W	24	1	575	2557	.678	17.22	.020	.51	.063	1.60	
7418W	33	1	782	3478	.762	19.36					

UL AWM 21486
(1000 V, +90 °C)
UL TC-ER
UL WTTC 1000 V
C(UL) Type TC & CIC FT4

16 AWG • 26 x 30

7421W	2	—	76	338	.301	7.65					
7422W	2	1	105	467	.316	8.03					
7423W	3	1	140	623	.342	8.69	.020	.51	.047	1.19	
7424W	4	1	175	778	.371	9.42					
7425W	6	1	245	1090	.434	11.02					
7426W	8	1	315	1401	.498	12.65					
7427W	11	1	420	1868	.550	13.97					
7428W	17	1	630	2802	.636	16.15	.020	.51	.063	1.60	
7429W	24	1	875	3892	.752	19.10					
7430W	33	1	1190	5293	.882	22.40	.020	.51	.085	2.16	

Conductor Color Coding: Black, Numbered, Green/Yellow Ground

BC = Bare Copper • PVC = Polyvinyl Chloride

MachFlex Flexible Control Cables

600 V MachFlex 360TC for Moderate Flexing (1 Million Flex Cycles)

FCC Control Cable • Unshielded



- UL AWM 2587 (600 V, +90 °C)
- CSA AWM I/II A/B 600 V +105 °C
- Sunlight Res
- Oil Res I/II
- UL Direct Burial
- IEEE 1202/383 FT4
- -40 °C to +90 °C (Cold Impact)
- -5 °C to +90 °C (Flexing)

Part No.	Conductors		Pull Tension (Max)		OD (Nom)		Insulation Thickness		Jacket Thickness		Additional Features/Ratings
	Circuit	Ground (Grn/Yel)	Lbs	N	Inch	mm	Inch	mm	Inch	mm	

Stranded BC Conductors • PVC/Nylon Insulation • Abrasion Resistant Chrome Belflex® TPE Jacket

14 AWG • 41 x 30

7435W	2	1	201	894	.329	8.36					
7436W	3	1	268	1192	.381	9.68	.020	.51	.047	1.19	
7438W	6	1	469	2086	.487	12.37					
7439W	8	1	603	2682	.593	15.06					
7440W	11	1	804	3576	.617	15.67	.020	.51	.063	1.60	
7442W	24	1	1675	7451	.895	22.73	.020	.51	.085	2.16	

12 AWG • 65 x 30

7444W	2	1	253	1125	.389	9.88	.020	.51	.047	1.19	
7445W	3	1	338	1503	.424	10.77					

UL AWM 21486
(1000 V, +90 °C)
UL TC-ER
UL WTTC 1000 V
C(UL) Type TC & CIC FT4

10 AWG • 105 x 30

7447W	3	1	672	2989	.546	13.87	.025	.64	.063	1.60	
-------	---	---	-----	------	------	-------	------	-----	------	------	--

6 AWG • 266 x 30

7453W	3	1	1472	6548	.875	22.23	.040	1.02	.085	2.16	
-------	---	---	------	------	------	-------	------	------	------	------	--

Conductor Color Coding: Black, Numbered, Green/Yellow Ground

BC = Bare Copper • PVC = Polyvinyl Chloride

MachFlex Flexible Control Cables

600 V MachFlex 360TC for Moderate Flexing (1 Million Flex Cycles)

FCC Control Cables • Braid Shielded • Double Jacketed



- UL AWM 2587 (600 V, +90 °C)
- CSA AWM I/II A/B 600 V +105 °C
- Sunlight Res
- Oil Res I/II
- UL Direct Burial
- IEEE 1202/383 FT4
- -40 °C to +90 °C (Cold Impact)
- -5 °C to +90 °C (Flexing)

Part No.	Conductors		Pull Tension (Max)		OD (Nom)		Insulation Thickness		Inner Jacket Thickness		Outer Jacket Thickness		Additional Features/Ratings
	Circuit	Ground (Grn/Yel)	Lbs	N	Inch	mm	Inch	mm	Inch	mm	Inch	mm	

Stranded BC Conductors • PVC Insulation • TPE Inner Jacket • 85% TC Braid Shield • Abrasion Resistant Chrome Belflex® TPE Jacket

20 AWG • 10 x 30

7401WS	2	1	39	173	.303	7.70								
7403WS	4	1	65	289	.339	8.61	.015	.38	.025	.64	.040	1.02		
7404WS	6	1	91	405	.409	10.39								
7408WS	24	1	325	1445	.595	15.11	.015	.38	.025	.64	.053	1.35	UL PLTC	

Stranded BC Conductors • PVC/Nylon Insulation • TPE Inner Jacket • 85% TC Braid Shield • Abrasion Resistant Chrome Belflex® TPE Jacket

18 AWG • 16 x 30

7410WS	2	1	69	307	.367	9.32								
7411WS	3	1	92	409	.391	9.93	.020	.51	.025	.64	.047	1.19		
7413WS	6	1	161	716	.468	11.89								
7415WS	11	1	276	1227	.578	14.68	.020	.51	.025	.64	.060	1.52		
7416WS	17	1	414	1842	.654	16.61								
7417WS	24	1	575	2557	.756	19.20	.020	.51	.025	.64	.063	1.60		

16 AWG • 26 x 30

7422WS	2	1	105	467	.394	10.01								
7423WS	3	1	140	623	.420	10.67	.020	.51	.025	.64	.047	1.19		
7427WS	11	1	420	1868	.628	15.95								
7428WS	17	1	630	2802	.714	18.14	.020	.51	.025	.64	.063	1.60	UL AWM 21486 (1000 V, +90 °C)	
7429WS	24	1	875	3892	.870	22.10	.020	.51	.025	.64	.080	2.03	CSA AWM I/II A/B	

UL AWM 21486 (1000 V, +90 °C)
 CSA AWM I/II A/B
 UL TC-ER
 UL WTTC 1000 V
 C(UL) Type TC & CIC FT4

14 AWG • 41 x 30

7435WS	2	1	201	894	.407	10.34	.020	.51	.025	.64	.047	1.19		
7438WS	6	1	469	2086	.598	15.19	.020	.51	.025	.64	.060	1.52		

12 AWG • 65 x 30

7445WS	3	1	338	1503	.544	13.82	.020	.51	.030	.76	.060	1.52		
--------	---	---	-----	------	------	-------	------	-----	------	-----	------	------	--	--

10 AWG • 105 x 30

7447WS	3	1	546	2429	.644	16.36	.025	.64	.035	.89	.063	1.60		
--------	---	---	-----	------	------	-------	------	-----	------	-----	------	------	--	--

8 AWG • 168 x 30

7450WS	3	1	872	3879	.910	23.11	.025	.64	.040	1.02	.085	2.16		
--------	---	---	-----	------	------	-------	------	-----	------	------	------	------	--	--

Conductor Color Coding: Black, Numbered, Green/Yellow Ground.

BC = Bare Copper • TC = Tinned Copper • PVC = Polyvinyl Chloride

UL Control Cables

600 V Type TC Cables – Overview

Introduction

Belden offers a wide selection of UL-rated 600 V Tray Cable for a variety of control applications.

Multi-conductor versions are available as standards from 18 to 4/0 AWG. These are unshielded and shielded versions that come with various insulation and jacket combinations.

These TC cables are installed in cable trays, ducts and conduit and can be used in direct burial applications. They are extensively used in manufacturing facilities, especially in the process industries such as petrochemical, steel, pulp and paper, cement and mining.

These flexible, space efficient cables can be substantially more economical than traditional wiring methods.

Construction

Soft annealed bare or tinned copper conductors, with various insulation and jacketing options as seen in chart below.

Application

These cables are suitable for installation in wet or dry locations. Cable jackets are resistant to sunlight, moisture and vapor penetration. The cables can be used in raceways (supported by messenger wire), outdoor applications and direct burial applications.

Unshielded

Cabled non-shielded conductors provide a minimal O.D. allowing greater tray and conduit fill. Non-shielded control cable may be utilized when recommended by the equipment manufacturer and used in a metallic conduit.

Overall Shield

Recommended for use in control applications where signals are transmitted in excess of 100 millivolts, except in areas where high voltage and current sources create excessive noise interference. The Beldfoil® shield with drain wire provides 100% coverage for maximum shield effectiveness. Copper tape shield available upon request.

Only 2-conductor round constructions can be shielded. Flat constructions cannot be shielded.

Tray Cable Construction Options

Insulation/Jacket	UL Listed for MC and TC		Flame Tests	Ratings*
	Max. Temp Rating			
	Wet	Dry		
PVC-Nylon/PVC (THHN or THWN) 14 AWG & larger	+75 °C	+90 °C	UL 1685 FT4/IEEE 1202/383 ICEA T-29-520	ICEA S-73-532 ICEA S-61-402
PVC-Nylon/PVC (TFN or TFFN) 16 & 18 AWG	+75 °C	+90 °C	UL 1685 FT4/IEEE 1202/383 ICEA T-29-520	ICEA S-73-532 ICEA S-61-402
XLP/PVC or CPE (XHHW-2) 14 AWG & larger	+90 °C	+90 °C	UL 1685 FT4/IEEE 1202/383 VW-1 rated singles ICEA T-29-520	ICEA S-73-532 ICEA S-66-524
XLP/PVC or CPE (RFH-2) 16 & 18 AWG	+90 °C	+90 °C	UL 1685 FT4/IEEE 1202/383 ICEA T-29-520	ICEA S-73-532 ICEA S-82-552
XLP/Haloarrest® (Thermoplastic) (XHHW-2) 14 AWG & larger (RFH-2) 16 & 18 AWG	+90 °C	+90 °C	UL 1685	TC-LS
XLP/HaloarrestXLink™-1 and -2 (Thermoset) (XHHW-2) 14 AWG & larger (RFH-2) 16 & 18 AWG	+90 °C	+90 °C	UL 1685 ICEA T-29-520 FT4/IEEE 1202/383	TC-ER ICEA S-73-532 T-33-655

* Applicable to TC-rated cables only.

Ground Wire

- Non-insulated, bare copper ground wires are included for constructions 8 through 4/0 AWG. Non-insulated, bare copper, full sized ground wires may be requested on other constructions.
- All shielded PVC-Nylon/PVC constructions, over three conductors, include full sized ground (drain) wires.

Color Code

Multi-conductor control cables (10 AWG to 18 AWG) are printed alpha-numerically in addition to being color coded per ICEA Table E2.

8 AWG and larger are black and numbered per ICEA Method 4.

Refer to Technical Information Section for ICEA color code charts.

Specifications

- UL Subject 1277 Type TC and TC-ER
- XLP/Haloarrest (thermoplastic) jacketed cables are UL 1277 TC-LS rated
- XLP/HaloarrestXLink™-1 and -2 are TC-ER rated
- UL Subject 1424 (per outline for NPLF requirements dated May 3, 1979)
- UL 1685 (UL 1581) Vertical Flame Test

- Approved for cable tray use in Class 1, Division 2 areas, per NEC Articles 340, 318 and 501, and for Class 1 circuits as permitted in Article 725
- PVC-Nylon/PVC, XLP/PVC and XLP/CPE constructed cables meet IEEE 1202/IEEE 383-2003/FT4 (70,000 BTU/hr) Flame Test

TC-ER Rated Cables

Belden offers all PVC-nylon/PVC, XLP/PVC and XLP/CPE jacketed tray cables with a TC-ER (Exposed Run) rating, formerly referred to as Open Wiring.

Per NEC Article 336, a TC-ER rated cable may be installed in an industrial establishment between a cable tray and the utilization equipment or device. A TC-ER rated cable must meet the crush and impact requirements of UL Type MC cable. By eliminating the need for metal conduit and/or armor, using a TC-ER rated cable results in savings in both installation and maintenance.

Standard lengths may be subject to tolerance. Custom lengths may be available upon request. Contact the Belden Electronics Division Customer Service Department for additional information. 1-800-BELDEN1.

CPE = Chlorinated Polyethylene • PVC = Polyvinyl Chloride • XLP = Cross-Linked Poly

UL Control Cables
600 V Type TC Cables



- UL TC-ER
- UL TC (2-Conductor Cables)
- UL Sunlight Res
- Oil Res
- Direct Burial
- NEC: NPLF
- ICEA S-73-532, S-61-402, T-29-520
- FT4
- IEEE 1202/383

Part No.	Conductors	Color Code	Pull Tension (Max)	Bend Radius (Min)		OD (Nom)		Jacket Thickness	
			Lbs	Inch	mm	Inch	mm	Inch	mm

18 AWG • Unshielded

Stranded (7 x 26) BC Conductors • PVC/Nylon Insulation • PVC Jacket									
27916A	2	E2	44	2.7	68.58	.180 x .266	4.57 x 6.76		
27325A	2	E2	44	2.7	68.58	.270	6.86		
28334A	3	E2	66	2.8	71.12	.280	7.11		
28326A	4	E2	88	3.1	78.74	.310	7.87		
28335A	5	E2	110	3.3	83.82	.330	8.38	.045	1.14
28600A	6	E2	132	3.5	88.90	.350	8.89		
28327A	7	E2	154	3.5	88.90	.350	8.89		
28601A	8	E2	176	3.8	96.52	.390	9.83		
28336A	9	E2	198	4.1	104.14	.410	10.41		
28328A	10	E2	220	4.5	114.30	.450	11.43		
28602A	11	E2	242	4.5	114.30	.450	11.43		
28329A	12	E2	264	4.5	114.30	.450	11.43		
28603A	13	E2	286	4.7	119.38	.470	11.94		
28604A	14	E2	308	4.8	121.92	.480	12.19		
28605A	15	E2	330	5.1	129.54	.510	12.95		
28606A	16	E2	352	5.0	127.00	.500	12.70	.060	1.52
28607A	17	E2	374	5.7	144.78	.570	14.48		
28608A	18	E2	396	5.7	144.78	.570	14.48		
28609A	19	E2	418	5.7	144.78	.570	14.48		
28610A	20	E2	440	5.9	149.86	.600	15.24		
28611A	25	E2	550	6.6	167.64	.660	16.76		
28612A	30	E2	660	6.6	167.64	.690	17.53		
28613A	37	E2	814	7.4	187.96	.740	18.80		
28614A	50	E2	1100	9.1	231.14	.910	23.11	.080	2.03
28632A	60	E2	1320	9.6	243.84	.960	24.38		

18 AWG • Overall Beldfoil® Shield

Stranded (7 x 26) BC Conductors • PVC/Nylon Insulation • PVC Jacket									
27325AS	2	E2	67	2.70	68.58	.270	6.86		
28334AS	3	E2	90	2.80	71.12	.280	7.11	.045	1.14
28326AS	4	E2	112	3.10	81.28	.300	7.62		

To Specify Conductor, Insulation and Jacket Options:		
12345	A	S
Start with Base Part No.	Add or Modify for Conductor, Insulation, and Jacket. See table at right.	Add "S" for Optional Beldfoil® Shield

Conductor		Insulation/Jacket	Conductor		Insulation/Jacket
Bare	Tinned		Bare	Tinned	
A	B	PVC-Nylon/PVC	S	T	XLP/Haloarrest®
C	D	XLP/PVC	U	V	XLP/HaloarrestXLink™-1
G	H	XLP/TPE	W	X	XLP/HaloarrestXLink-2
Q	R	XLP/CPE	Y	Z	XLP/HaloarrestXLink-2, Marine Approved

BC = Bare Copper • CPE = Chlorinated Polyethylene • PVC = Polyvinyl Chloride • TPE = Thermoplastic Elastomer • XLP = Cross-Linked Poly

UL Control Cables
600 V Type TC Cables

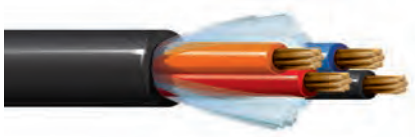

- UL TC-ER
- UL TC (2-Conductor Cables)
- UL Sunlight Res
- Oil Res
- Direct Burial
- NEC: NPLF
- ICEA S-73-532, S-61-402, T-29-520
- FT4
- IEEE 1202/383

Part No.	Conductors	Color Code	Pull Tension (Max)		Bend Radius (Min)		OD (Nom)		Jacket Thickness	
			Lbs	Inch	Inch	mm	Inch	mm	Inch	mm

16 AWG • Unshielded

Stranded (7 x 24) BC Conductors • PVC/Nylon Insulation • PVC Jacket										
27917A	2	E2	70	2.9	73.66	.190 x .290	4.83 x 7.37			
27337A	2	E2	70	2.9	73.66	.299	7.60			
28331A	3	E2	105	3.1	78.74	.307	7.80			
28338A	4	E2	140	3.3	83.82	.332	8.18			
28339A	5	E2	175	3.6	91.44	.360	9.14			
28615A	6	E2	210	3.9	99.06	.390	9.91			
28323A	7	E2	245	3.9	99.06	.390	9.91	.045	1.14	
28616A	8	E2	280	4.2	106.68	.420	10.67			
28340A	9	E2	315	4.5	114.30	.450	11.43			
28617A	10	E2	350	4.9	124.46	.490	12.45			
28618A	11	E2	385	4.9	124.46	.490	12.45			
28341A	12	E2	420	5.0	127.00	.500	12.70			
28619A	13	E2	455	5.7	144.78	.570	14.48			
28620A	14	E2	490	5.7	144.78	.570	14.48			
28621A	15	E2	525	5.9	149.86	.590	14.99	.060	1.52	
28330A	16	E2	560	6.0	152.40	.600	15.24	.045	1.14	
28622A	17	E2	595	6.3	160.02	.630	16.00			
28623A	18	E2	630	6.3	160.02	.630	16.00	.060	1.52	
28624A	19	E2	665	6.3	160.02	.630	16.00			
28625A	20	E2	700	6.6	167.64	.660	16.76			
28324A	25	E2	875	7.3	185.42	.730	18.54			
28626A	30	E2	1050	7.7	195.58	.770	19.56			
28627A	37	E2	1295	8.3	210.82	.830	21.08	.080	2.03	
28628A	50	E2	1750	10.0	254.00	1.000	25.40			
28633A	60	E2	2100	11.0	279.40	1.100	27.94			

16 AWG • Overall Beldfoil® Shield

Stranded (7 x 24) BC Conductors • PVC/Nylon Insulation • PVC Jacket										
27337AS	2	E2	94	3.00	76.20	.302	7.67	.045	1.14	
28331AS	3	E2	130	3.20	81.28	.320	8.13			

14 AWG • Unshielded

Stranded (7 x 22) BC Conductors • PVC/Nylon Insulation • PVC Jacket										
27080A	2	E2	108	3.5	88.90	.210 x .320	5.33 x 8.13			
27636A	2	E2	108	3.2	81.28	.320	8.13	.045	1.14	
28081A	3	E2	162	3.4	86.36	.340	8.64			

BC = Bare Copper • CPE = Chlorinated Polyethylene • PVC = Polyvinyl Chloride • TPE = Thermoplastic Elastomer • XLP = Cross-Linked Poly

UL Control Cables
600 V Type TC Cables



- UL TC-ER
- UL TC (2-Conductor Cables)
- UL Sunlight Res
- Oil Res
- Direct Burial
- NEC: NPLF
- ICEA S-73-532, S-61-402, T-29-520
- FT4
- IEEE 1202/383

Part No.	Conductors	Color Code	Pull Tension (Max)		Bend Radius (Min)		OD (Nom)		Jacket Thickness	
			Lbs	Inch	mm	Inch	mm	Inch	mm	

14 AWG • Unshielded (continued)

Stranded (7 x 22) BC Conductors • PVC/Nylon Insulation • PVC Jacket										
28082A	4	E2	216	3.6	91.44	.360	9.14			
28083A	5	E2	270	3.9	99.06	.400	10.16			
28084A	6	E2	324	4.3	109.22	.434	11.02	.045	1.14	
28085A	7	E2	378	4.3	109.22	.433	11.00			
28086A	8	E2	432	4.7	119.38	.480	12.19			
28087A	9	E2	486	5.1	129.54	.510	12.95			
28088A	10	E2	540	5.7	144.78	.588	14.94			
28089A	11	E2	594	5.9	149.86	.595	15.11			
28090A	12	E2	648	5.9	149.86	.595	15.11			
28091A	13	E2	702	6.3	160.02	.640	16.26			
28092A	14	E2	756	6.3	160.02	.640	16.26			
28093A	15	E2	810	6.7	170.18	.670	17.02			
28094A	16	E2	864	6.6	167.64	.671	17.04			
28095A	17	E2	918	7.0	177.80	.700	17.78			
28096A	18	E2	972	7.0	177.80	.700	17.78	.060	1.52	
28097A	19	E2	1026	7.0	177.80	.705	17.91			
28098A	20	E2	1080	7.4	187.96	.735	18.67			
28099A	21	E2	1134	7.4	187.96	.740	18.80			
28100A	22	E2	1188	7.6	193.04	.760	19.30			
28101A	23	E2	1242	7.6	193.04	.760	19.30			
28102A	24	E2	1296	8.1	205.74	.810	20.57			
28103A	25	E2	1350	8.1	205.74	.810	20.57			
28104A	26	E2	1404	8.1	205.74	.810	20.57			
28105A	27	E2	1458	8.7	220.98	.870	22.10			
28106A	28	E2	1512	9.1	231.14	.910	23.11			
28107A	29	E2	1566	9.1	231.14	.910	23.11	.080	2.03	
28108A	30	E2	1620	9.0	228.60	.902	22.91			
28629A	37	E2	1998	9.7	246.38	.975	24.77			
28912A	50	E2	2700	11.3	287.02	1.138	28.91			



- UL TC-ER
- UL TC (2-Conductor Cables)
- UL Sunlight Res
- Oil Res
- Direct Burial
- NEC: NPLF
- ICEA S-73-532, S-61-402, T-29-520
- FT4
- IEEE 1202/383

Part No.	Conductors	Color Code	Pull Tension (Max)		Bend Radius (Min)		OD (Nom)		Jacket Thickness	
			Lbs	Inch	mm	Inch	mm	Inch	mm	

14 AWG • Overall Beldfoil® Shield

Stranded (7 x 22) BC Conductors • PVC/Nylon Insulation • PVC Jacket										
28081AS	3	E2	99	3.4	86.36	.340	8.64	.045	1.14	
28082AS	4	E2	273	3.9	99.06	.391	9.93			

BC = Bare Copper • PVC = Polyvinyl Chloride

UL Control Cables
600 V Type TC Cables



- UL TC-ER
- UL TC (2-Conductor Cables)
- UL Sunlight Res
- Oil Res
- Direct Burial
- NEC: NPLF
- ICEA S-73-532, S-61-402, T-29-520
- FT4
- IEEE 1202/383

Part No.	Conductors	Color Code	Pull Tension (Max)		Bend Radius (Min)		OD (Nom)		Jacket Thickness	
			Lbs		Inch	mm	Inch	mm	Inch	mm

12 AWG • Unshielded

Stranded (7 x 20) BC Conductors • PVC/Nylon Insulation • PVC Jacket										
27109A	2	E2	172	3.5	88.90	.220 x .350	5.59 x 8.89			
27641A	2	E2	172	3.6	91.44	.360	9.14			
28110A	3	E2	258	3.7	93.98	.374	9.50			
28111A	4	E2	344	4.1	104.14	.410	10.41	.045	1.14	
28112A	5	E2	430	4.5	114.30	.450	11.43			
28113A	6	E2	516	4.8	121.92	.480	12.19			
28114A	7	E2	602	4.8	121.92	.480	12.19			
28115A	8	E2	688	5.6	142.24	.560	14.22			
28116A	9	E2	774	6.0	152.40	.600	15.24			
28117A	10	E2	860	6.6	167.64	.660	16.76			
28118A	11	E2	946	6.7	170.18	.670	17.02			
28119A	12	E2	1032	6.7	170.18	.670	17.02			
28120A	13	E2	1118	7.0	177.80	.700	17.78	.060	1.52	
28121A	14	E2	1204	7.0	177.80	.700	17.78			
28122A	15	E2	1290	7.4	187.96	.740	18.80			
28123A	16	E2	1376	7.5	190.50	.750	19.05			
28124A	17	E2	1462	7.7	195.58	.770	19.56			
28125A	18	E2	1548	7.7	195.58	.770	19.56			
28126A	19	E2	1634	7.9	200.66	.790	20.07			
28127A	20	E2	1720	8.7	220.98	.870	22.10			
28128A	21	E2	1806	8.7	220.98	.870	22.10			
28129A	22	E2	1892	8.9	226.06	.890	22.61			
28130A	23	E2	1978	8.9	226.06	.890	22.61			
28131A	24	E2	2064	9.4	238.76	.940	23.88			
28132A	25	E2	2150	9.6	243.84	.960	24.38			
28133A	26	E2	2236	9.6	243.84	.960	24.38	.080	2.03	
28134A	27	E2	2322	9.6	243.84	.960	24.38			
28135A	28	E2	2408	9.9	251.46	.990	25.15			
28136A	29	E2	2494	9.9	251.46	.990	25.15			
28137A	30	E2	2580	10.2	259.08	1.020	25.91			
28630A	37	E2	3182	10.9	276.86	1.090	27.69			
28634A	50	E2	4300	13.0	330.20	1.300	33.02			

To Specify Conductor, Insulation and Jacket Options:		
12345	A	S
Start with Base Part No.	Add or Modify for Conductor, Insulation, and Jacket. See table at right.	Add "S" for Optional Beldfoil® Shield

Conductor		Insulation/Jacket	Conductor		Insulation/Jacket
Bare	Tinned		Bare	Tinned	
A	B	PVC-Nylon/PVC	S	T	XLP/Haloarrest®
C	D	XLP/PVC	U	V	XLP/HaloarrestXLink™-1
G	H	XLP/TPE	W	X	XLP/HaloarrestXLink-2
Q	R	XLP/CPE	Y	Z	XLP/HaloarrestXLink-2, Marine Approved

BC = Bare Copper • CPE = Chlorinated Polyethylene • PVC = Polyvinyl Chloride • TPE = Thermoplastic Elastomer • XLP = Cross-Linked Poly

UL Control Cables
600 V Type TC Cables



- UL TC-ER
- UL TC (2-Conductor 10 AWG Cables)
- UL Sunlight Res
- Oil Res
- Direct Burial
- NEC: NPLF
- ICEA S-73-532, S-61-402, T-29-520
- FT4
- IEEE 1202/383

Part No.	Conductors	Color Code	Pull Tension (Max)		Bend Radius (Min)		OD (Nom)		Jacket Thickness	
			Lbs		Inch	mm	Inch	mm	Inch	mm

10 AWG • Unshielded

Stranded (7 x 18) BC Conductors • PVC/Nylon Insulation • PVC Jacket										
27138A	2	E2	296		4.2	106.68	.260 x .420	6.60 x 10.67		
27643A	2	E2	296		4.2	106.68	.420	10.67	.045	1.14
28139A	3	E2	444		4.5	114.30	.450	11.43		
28140A	4	E2	592		4.9	124.46	.490	12.45		
28141A	5	E2	740		5.7	144.78	.570	14.48		
28142A	6	E2	888		6.2	157.48	.620	15.75		
28143A	7	E2	1036		6.2	157.48	.620	15.75		
28144A	8	E2	1184		6.8	172.72	.680	17.27	.060	1.52
28145A	9	E2	1332		7.2	182.88	.720	18.29		
28146A	10	E2	1480		7.9	200.66	.790	20.07		
28147A	11	E2	1628		7.9	200.66	.790	20.07		
28148A	12	E2	1776		8.2	208.28	.820	20.83	.080	2.03

8 AWG • Unshielded • 10 AWG Uninsulated Ground Wire

Stranded (7 x 16) BC Conductors • PVC/Nylon Insulation • PVC Jacket										
28149A	2	M4	384		5.6	142.24	.560	14.22		
28150A	3	M4	576		5.9	149.86	.590	14.99	.060	1.52
28151A	4	M4	768		6.5	165.10	.650	16.51		

6 AWG • Unshielded • 8 AWG Uninsulated Ground Wire

Stranded (7 x 14) BC Conductors • PVC/Nylon Insulation • PVC Jacket										
28152A	2	M4	610		6.3	160.02	.630	16.00		
28153A	3	M4	915		6.7	170.18	.670	17.02	.060	1.52
28154A	4	M4	1220		7.3	185.42	.730	18.54		

To Specify Conductor, Insulation and Jacket Options:		
12345	A	S
Start with Base Part No.	Add or Modify for Conductor, Insulation, and Jacket. See table at right.	Add "S" for Optional Beldfoil® Shield

Conductor		Insulation/Jacket	Conductor		Insulation/Jacket
Bare	Tinned		Bare	Tinned	
A	B	PVC-Nylon/PVC	S	T	XLP/Halobarrest®
C	D		U	V	XLP/HalobarrestXLInk™-1
G	H	XLP/TPE	W	X	XLP/HalobarrestXLInk-2
Q	R	XLP/CPE	Y	Z	XLP/HalobarrestXLInk-2, Marine Approved

BC = Bare Copper • CPE = Chlorinated Polyethylene • PVC = Polyvinyl Chloride • TPE = Thermoplastic Elastomer • XLP = Cross-Linked Poly

UL Control Cables
600 V Type TC Cables



- UL TC-ER
- UL Sunlight Res
- Oil Res
- Direct Burial
- NEC: NPLF
- ICEA S-73-532, S-61-402, T-29-520
- FT4
- IEEE 1202/383

Part No.	Conductors	Color Code	Pull Tension (Max)		Bend Radius (Min)		OD (Nom)		Jacket Thickness	
			Lbs		Inch	mm	Inch	mm	Inch	mm

4 AWG • Unshielded • 8 AWG Uninsulated Ground Wire

Stranded (7 x 12) BC Conductors • PVC/Nylon Insulation • PVC Jacket										
28155A	2	M4	970	7.7	195.58	.770	19.56		.060	1.52
28156A	3	M4	1455	8.2	208.28	.820	20.83		.080	2.03
28157A	4	M4	1940	9.5	241.30	.950	24.13			

2 AWG • Unshielded • 6 AWG Uninsulated Ground Wire

Stranded (7 x 10) BC Conductors • PVC/Nylon Insulation • PVC Jacket										
28158A	2	M4	1544	9.7	246.38	.970	24.64			
28159A	3	M4	2316	9.9	251.46	.990	25.15		.080	2.03
28160A	4	M4	3088	10.9	276.86	1.090	27.69			

1 AWG • Unshielded • 6 AWG Uninsulated Ground Wire

Stranded (19 x 14) BC Conductors • PVC/Nylon Insulation • PVC Jacket										
28165A	2	M4	1340	10.7	271.78	1.060	26.92		.080	2.03
28161A	3	M4	2919	11.2	284.48	1.120	28.45		.080	2.03
28166A	4	M4	2680	12.5	317.5	1.250	31.75		.080	2.03

1/0 AWG • Unshielded • 6 AWG Uninsulated Ground Wire

Stranded (19 x 12) BC Conductors • PVC/Nylon Insulation • PVC Jacket										
28167A	2	M4	1690	11.4	289.56	1.13	28.70		.080	2.03
28168A	3	M4	2535	12.1	307.34	1.21	30.73		.083	2.11
28169A	4	M4	3380	13.4	340.36	1.33	33.78			

2/0 AWG • Unshielded • 6 AWG Uninsulated Ground Wire

Stranded (19 x 11) BC Conductors • PVC/Nylon Insulation • PVC Jacket										
28170A	2	M4	2130	12.2	309.88	1.22	30.99			
28171A	3	M4	3195	13.0	330.20	1.30	33.02		.083	2.11
28172A	4	M4	4260	14.4	365.76	1.44	36.58			

3/0 AWG • Unshielded • 4 AWG Uninsulated Ground Wire

Stranded (19 x 10) BC Conductors • PVC/Nylon Insulation • PVC Jacket										
28173A	2	M4	2686	13.1	332.74	1.31	33.27			
28174A	3	M4	4029	14.2	360.68	1.42	36.07		.083	2.11
28175A	4	M4	5372	15.6	396.24	1.56	39.62			

4/0 AWG • Unshielded • 4 AWG Uninsulated Ground Wire

Stranded (19 x 9.5) BC Conductors • PVC/Nylon Insulation • PVC Jacket										
28176A	2	M4	3386	14.2	360.68	1.42	36.07			
28177A	3	M4	5078	15.4	391.16	1.54	39.12		.083	2.11
28178A	4	M4	6771	17.7	449.58	1.77	44.96		.116	2.95

To Specify Conductor, Insulation and Jacket Options:		
12345	A	S
Start with Base Part No.	Add or Modify for Conductor, Insulation, and Jacket. See table at right.	Add "S" for Optional Beldfoil® Shield

Conductor		Insulation/Jacket	Conductor		Insulation/Jacket
Bare	Tinned		Bare	Tinned	
A	B	PVC-Nylon/PVC	S	T	XLP/Haloarrest®
C	D	XLP/PVC	U	V	XLP/HaloarrestXLink™-1
G	H	XLP/TPE	W	X	XLP/HaloarrestXLink-2
Q	R	XLP/CPE	Y	Z	XLP/HaloarrestXLink-2, Marine Approved

BC = Bare Copper • CPE = Chlorinated Polyethylene • PVC = Polyvinyl Chloride • TPE = Thermoplastic Elastomer • XLP = Cross-Linked Poly

UL Control Cables

600 V Type MC Metal Clad and Teck-Style® Cables – Overview

Metal Clad

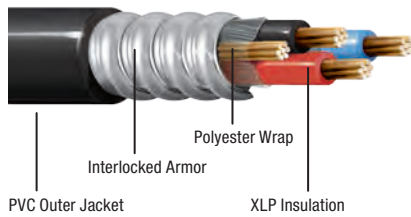

Teck-Style

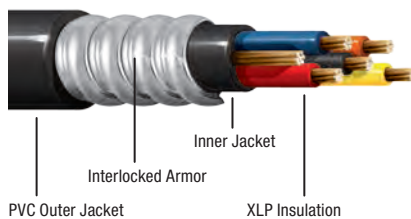

Introduction

Belden Metal Clad (MC) and Teck-Style cables are designed to meet demanding industrial needs by combining rugged durability and corrosion resistance with flexibility and easy handling.

MC and Teck-Style cables are available in a wide range of constructions for installation in demanding industrial environments including oil and gas, mining, utility, chemical, pulp and paper, and others. They are ideal for use in wet or dry areas, ventilated or non-ventilated, ladder-type cable troughs and flexible cableways. Custom cables are available to meet exacting requirements.

Belden Type MC Cable is sunlight-resistant and appropriate for outdoor use, installation in cable trays, and direct burial.

Teck-Style cables are price-competitive, high-performance, UL and CSA dual-rated cables with a flame-retardant XHHW insulated conductor and an inner PVC jacket for mechanical moisture and corrosion protection.

Construction

Class B stranded bare copper conductors, XLP insulation, bare copper ground wire, standard aluminum or optional galvanized steel interlocking armor, PVC outer jacket.

- Thermoset insulation – XHHW-2 conductors
- NEC conductor temperature +90 °C dry and +90 °C wet

Voltage Rating

14 AWG – 2 AWG: 600 Volt

Application

Type MC Cable is a general-purpose cable used in the pulp and paper, mining, petroleum and chemical industries as well as in commercial buildings.

MC Cable may be used under the following conditions:

- Exposed or concealed wiring in dry or wet conditions
- In ventilated, non-ventilated or ladder-type cable trays in dry or wet conditions
- On walls or beams
- Directly buried
- Class I and II Div. 2 and Class III Div. 1 and 2 hazardous locations

Minimum Bending Radius

12 times the overall cable diameter

Pulling Tensions

The combined use of Kellems grips and pulling eyes is recommended.

Design Advantages

Insulation Properties

- High tensile strength
- Impact- and crush-resistant
- Heat-resistant
- Excellent elongation
- Moisture-resistant
- Good low temperature properties
- +90 °C dry and +90 °C wet

Electrical Properties

- High insulation resistance
- Low dielectric loss
- High dielectric strength

Other Features

- Corrosion-resistant
- Versatile and flexible
- Provides cost savings as conduit and ducts are not required

Specifications

- UL 44
- UL 1569
- UL 1685 (UL 1581) Vertical Tray Flame Test (70,000 BTU/hr)

Teck-Style CSA Specifications

- CSA C22.2 No. 131
- FT4 Flame Test
- HAZ LOC
- CSA C22.2 No. 0.3 Clause 4.31 Low Acid Gas

UL Control Cables
600 V Type MC Metal Clad Cables

Interlocked Armor



- UL MC
- UL Sun Res
- Oil Res
- Direct Burial

Part No.		Conductors	Color Code	Armor OD		OD (Nom)		Bend Radius (Min)		Insulation Thickness		Jacket Thickness	
Aluminum	Steel			Inch	mm	Inch	mm	Inch	mm	Inch	mm	Inch	mm

Stranded (7 x 22) BC Conductors • XLP Insulation • Interlocked Armor • PVC Jacket

14 AWG • 14 AWG Uninsulated Ground Wire

27243	28243	2	E2	.48	12.19	.58	14.73	7.3	185				
27244	28244	3	E2	.50	12.70	.61	15.49	7.6	193				
27245	28245	4	E2	.54	13.72	.64	16.26	7.9	200				
27246	28246	5	E2	.57	14.48	.68	17.27	8.4	213				
27247	28247	6	E2	.62	15.75	.72	18.29	8.9	226				
27248	28248	7	E2	.62	15.75	.72	18.29	8.9	226				
27269	28269	8	E2	.69	17.53	.80	20.32	9.4	238				
27535	28535	9	E2	.70	17.78	.80	20.32	10.0	254				
27249	28249	10	E2	.75	19.05	.85	21.59	10.5	266	.030	.76	.050	1.27
27250	28250	12	E2	.77	19.56	.87	22.10	10.8	274				
27251	28251	15	E2	.87	22.10	.98	24.89	11.6	294				
27969	28969	19	E2	1.00	25.40	1.11	28.19	12.1	307				
27252	28252	20	E2	1.03	26.16	1.14	28.96	13.3	337				
27270	28270	25	E2	1.10	27.94	1.21	30.73	14.4	365				
27253	28253	30	E2	1.18	29.97	1.29	32.77	15.1	383				
27292	28292	37	E2	1.14	28.96	1.24	31.50	16.1	408				
27433	28433	40	E2	1.28	32.51	1.40	35.56	16.7	424				
27434	28434	50	E2	1.40	35.56	1.52	38.61	18.4	467				

Stranded (7 x 20) BC Conductors • XLP Insulation • Interlocked Armor • PVC Jacket

12 AWG • 12 AWG Uninsulated Ground Wire

27254	28254	2	E2	.52	13.21	.62	15.75	7.8	198				
27255	28255	3	E2	.54	13.72	.64	16.26	8.0	203				
27256	28256	4	E2	.58	14.73	.68	17.22	8.5	215				
27271	28271	5	E2	.62	15.75	.72	18.29	9.1	231				
27272	28272	6	E2	.67	17.02	.77	19.56	9.6	243				
27273	28273	7	E2	.67	17.02	.77	19.56	9.6	243				
27274	28274	8	E2	.77	19.56	.88	22.35	10.2	259				
27538	28538	9	E2	.76	19.30	.86	21.84	10.8	274				
27275	28275	10	E2	.80	20.32	.91	23.11	11.5	292	.030	.76	.050	1.27
27276	28276	12	E2	.84	21.34	.94	23.88	11.7	297				
27277	28277	15	E2	.94	23.88	1.05	26.67	13.4	340				
27539	28539	19	E2	.05	26.67	1.16	29.46	14.0	355				
27278	28278	20	E2	.16	29.46	1.27	32.26	14.6	370				
27279	28279	25	E2	.26	32.00	1.37	34.80	15.8	401				
27280	28280	30	E2	.29	32.77	1.40	35.56	16.8	426				
27540	28540	37	E2	.44	36.58	1.55	39.37	17.8	452				
27432	28432	40	E2	.50	38.10	1.63	41.40	18.4	467				

BC = Bare Copper • PVC = Polyvinyl Chloride • XLP = Cross-Linked Poly

UL Control Cables

600 V Type MC Metal Clad Cables

Interlocked Armor



- UL MC
- UL Sun Res
- Oil Res
- Direct Burial

Part No.		Conductors	Color Code	Armor OD		OD (Nom)		Bend Radius (Min)		Insulation Thickness		Jacket Thickness	
Aluminum	Steel			Inch	mm	Inch	mm	Inch	mm	Inch	mm	Inch	mm

Stranded (7 x 18) BC Conductors • XLP Insulation • Interlocked Armor • PVC Jacket

10 AWG • 10 AWG Uninsulated Ground Wire

Part No.	Part No.	Conductors	Color Code	Armor OD (Inch)	Armor OD (mm)	OD (Nom) (Inch)	OD (Nom) (mm)	Bend Radius (Min) (Inch)	Bend Radius (Min) (mm)	Insulation Thickness (Inch)	Insulation Thickness (mm)	Jacket Thickness (Inch)	Jacket Thickness (mm)
27257	28257	2	E2	.56	14.22	.67	17.02	8.4	213				
27258	28258	3	E2	.58	14.73	.69	17.53	8.6	218				
27259	28259	4	E2	.62	15.75	.74	18.80	9.2	233				
27281	28281	5	E2	.68	17.27	.79	20.07	12.8	325				
27282	28282	6	E2	.74	18.80	.84	21.34	10.4	264				
27283	28283	7	E2	.74	18.80	.84	21.34	10.4	264	.030	.76	.050	1.27
27284	28284	8	E2	.81	20.57	.92	23.37	11.2	284				
27541	28541	9	E2	.87	22.10	.98	24.89	11.8	299				
27285	28285	10	E2	.89	22.61	1.03	26.16	13.3	337				
27286	28286	12	E2	1.01	25.65	1.12	28.45	13.7	347				
27287	28287	15	E2	1.09	27.69	1.22	30.99	14.8	375				
27288	28288	20	E2	1.22	30.99	1.35	34.29	16.2	411				
27289	28289	25	E2	1.32	33.53	1.47	37.34	17.8	452	.030	.76	.055	1.40
27290	28290	30	E2	1.42	36.07	1.55	39.37	18.6	472				

Stranded (7 x 16) BC Conductors • XLP Insulation • Interlocked Armor • PVC Jacket

8 AWG • 8 AWG Uninsulated Ground Wire

Part No.	Part No.	Conductors	Color Code	Armor OD (Inch)	Armor OD (mm)	OD (Nom) (Inch)	OD (Nom) (mm)	Bend Radius (Min) (Inch)	Bend Radius (Min) (mm)	Insulation Thickness (Inch)	Insulation Thickness (mm)	Jacket Thickness (Inch)	Jacket Thickness (mm)
27291	28291	2	M4	.70	17.78	.81	20.57	9.8	248				
27260	28260	3	M4	.72	18.29	.82	20.83	10.2	259	.045	1.14	.050	1.27
27261	28261	4	M4	.78	19.81	.88	22.35	10.9	276				

Stranded (7 x 14) BC Conductors • XLP Insulation • Interlocked Armor • PVC Jacket

6 AWG • 8 AWG Uninsulated Ground Wire

Part No.	Part No.	Conductors	Color Code	Armor OD (Inch)	Armor OD (mm)	OD (Nom) (Inch)	OD (Nom) (mm)	Bend Radius (Min) (Inch)	Bend Radius (Min) (mm)	Insulation Thickness (Inch)	Insulation Thickness (mm)	Jacket Thickness (Inch)	Jacket Thickness (mm)
27293	28293	2	M4	.76	19.30	.87	22.10	10.7	271				
27262	28262	3	M4	.80	20.32	.90	22.86	11.2	284	.045	1.14	.050	1.27
27263	28263	4	M4	.87	22.10	.97	24.64	12.1	307				

Stranded (7 x 12) BC Conductors • XLP Insulation • Interlocked Armor • PVC Jacket

4 AWG • 8 AWG Uninsulated Ground Wire

Part No.	Part No.	Conductors	Color Code	Armor OD (Inch)	Armor OD (mm)	OD (Nom) (Inch)	OD (Nom) (mm)	Bend Radius (Min) (Inch)	Bend Radius (Min) (mm)	Insulation Thickness (Inch)	Insulation Thickness (mm)	Jacket Thickness (Inch)	Jacket Thickness (mm)
27264	28264	3	M4	1.90	22.86	1.00	25.40	13.1	332				
27265	28265	4	M4	1.97	50.04	1.08	27.43	14.2	360	.045	1.14	.050	1.27

Stranded (7 x 10) BC Conductors • XLP Insulation • Interlocked Armor • PVC Jacket

2 AWG • 6 AWG Uninsulated Ground Wire

Part No.	Part No.	Conductors	Color Code	Armor OD (Inch)	Armor OD (mm)	OD (Nom) (Inch)	OD (Nom) (mm)	Bend Radius (Min) (Inch)	Bend Radius (Min) (mm)	Insulation Thickness (Inch)	Insulation Thickness (mm)	Jacket Thickness (Inch)	Jacket Thickness (mm)
27267	28267	3	M4	1.02	25.91	1.13	28.70	14.7	373				
27268	28268	4	M4	1.11	28.19	1.22	30.99	16.0	406	.045	1.14	.050	1.27

BC = Bare Copper • PVC = Polyvinyl Chloride • XLP = Cross-Linked Poly

UL Control Cables
600 V Type MC Metal Clad Cables

Interlocked Armor • Composite Cables



- UL MC
- UL Sun Res
- Oil Res
- Direct Burial

Part No.		Conductors	Color Code	Armor OD		OD (Nom)		Bend Radius (Min)		Insulation Thickness		Jacket Thickness	
Aluminum	Steel			Inch	mm	Inch	mm	Inch	mm	Inch	mm	Inch	mm

Stranded (7 x 22 and 7 x 20) BC Conductors • XLP Insulation • Interlocked Armor • PVC Jacket

14 AWG and 12 AWG • 12 AWG Uninsulated Ground Wire

27428	28428	3 + 3	Note 1	.70	17.78	.81	20.57	9.7	2468	.030	.76	.050	1.27
-------	-------	-------	--------	-----	-------	-----	-------	-----	------	------	-----	------	------

Stranded (7 x 22 and 7 x 18) BC Conductors • XLP Insulation • Interlocked Armor • PVC Jacket

14 AWG and 10 AWG • 10 AWG Uninsulated Ground Wire

27429	28429	3 + 3	Note 1	.74	18.80	.85	21.59	10.2	259	.030	.76	.050	1.27
-------	-------	-------	--------	-----	-------	-----	-------	------	-----	------	-----	------	------

Stranded (7 x 22 and 7 x 16) BC Conductors • XLP Insulation • Interlocked Armor • PVC Jacket

14 AWG and 8 AWG • 10 AWG Uninsulated Ground Wire

27430	28430	3 + 3	Note 1	.83	21.08	.94	23.88	11.2	284	.030 (14 AWG)	.76	.050	1.27
										.045 (8 AWG)	1.14		

Stranded (7 x 22 and 7 x 14) BC Conductors • XLP Insulation • Interlocked Armor • PVC Jacket

14 AWG and 6 AWG • 6 AWG Uninsulated Ground Wire

27431	28431	3 + 3	Note 1	.89	22.61	1.01	25.65	12.0	304	.030 (14 AWG)	.76	.050	1.27
										.045 (8 AWG)	1.14		

Note 1: 14, 12, and 10 AWG use ICEA Table E2 with printed numbers. 8 AWG and larger, use ICEA M4 with printed numbers.

BC = Bare Copper • PVC = Polyvinyl Chloride • XLP = Cross-Linked Poly

Dual Rated UL/CSA Control Cables

600 V Teck-Style® Cables: Dual-Rated Type MC/TECK 90

Interlocked Armor



- UL MC
- CSA C22.2 No.131 FT4 Flame Test, HAZ LOC
- CSA C22.2 No. 0.3 Clause 4.31 Low Acid Gas
- Direct Burial

Part No.		Conductors	Color Code	Inner Jacket OD		Armor OD		OD (Nom)		Pull Tension (Max)		Bend Radius (Min)		Insulation Thickness	
Aluminum	Steel			Inch	mm	Inch	mm	Inch	mm	Lbs	N	Inch	mm	Inch	mm

Stranded (7 x 22) BC Conductors • XLP Insulation • PVC Inner Jacket • Interlocked Armor • PVC Outer Jacket

14 AWG • 14 AWG Uninsulated Ground Wire

27840	28840	2	E2	.37	9.40	.56	14.22	.67	17.02	66	294	8.0	203		
27841	28841	3	E2	.39	9.91	.58	14.73	.69	17.53	98	436	8.3	211		
27842	28842	4	E2	.43	10.92	.62	15.75	.73	18.54	131	583	8.7	221		
27843	28843	5	E2	.47	11.94	.66	16.76	.77	19.56	164	730	9.2	234		
27844	28844	6	E2	.51	12.95	.70	17.78	.81	20.57	191	850	9.7	246		
27845	28845	7	E2	.51	12.95	.70	17.78	.81	20.57	225	1001	9.7	246		
27846	28846	8	E2	.58	14.73	.77	19.56	.88	22.35	260	1157	10.5	267		
27847	28847	10	E2	.67	17.02	.93	23.62	1.04	26.42	321	1428	12.5	318	.030	.76
27848	28848	12	E2	.69	17.53	.95	24.13	1.06	26.92	388	1726	10.9	277		
27849	28849	15	E2	.77	19.56	1.03	26.16	1.14	28.96	481	2140	13.7	348		
27850	28850	20	E2	.86	21.84	1.12	28.45	1.23	31.24	649	2887	15.3	389		
27851	28851	25	E2	.92	23.37	1.18	29.97	1.30	33.02	810	3603	16.3	414		
27852	28852	30	E2	.98	24.89	1.24	31.50	1.36	34.54	975	4337	17.0	432		
27885	28885	40	E2	1.09	27.69	1.35	34.29	1.47	37.34	1301	5787	18.5	470		
27886	28886	50	E2	1.19	30.23	1.45	36.83	1.57	39.88	1630	7251	19.8	503		

Stranded (7 x 20) BC Conductors • XLP Insulation • PVC Inner Jacket • Interlocked Armor • PVC Outer Jacket

12 AWG • 12 AWG Uninsulated Ground Wire

27853	28853	2	E2	.41	10.41	.60	15.24	.71	18.03	104	463	8.5	216		
27854	28854	3	E2	.43	10.92	.62	15.75	.73	18.54	156	694	8.8	224		
27855	28855	4	E2	.47	11.94	.66	16.76	.77	19.56	207	921	9.2	234		
27856	28856	5	E2	.52	13.21	.71	18.03	.82	20.83	260	1157	9.8	249		
27857	28857	6	E2	.59	14.99	.78	19.81	.89	22.61	310	1379	10.7	272		
27858	28858	7	E2	.59	14.99	.78	19.81	.89	22.61	361	1606	10.7	272		
27859	28859	8	E2	.64	16.26	.83	21.08	.94	23.88	415	1846	11.3	287		
27860	28860	10	E2	.75	19.05	1.01	25.65	1.12	28.45	520	2313	13.4	340	.030	.76
27861	28861	12	E2	.77	19.56	1.03	26.16	1.14	28.96	619	2753	13.7	348		
27862	28862	15	E2	.87	22.10	1.13	28.70	1.25	31.75	718	3194	15.0	381		
27863	28863	20	E2	.96	24.38	1.22	30.99	1.33	33.78	1040	4626	15.9	404		
27864	28864	25	E2	1.04	26.42	1.30	33.02	1.42	36.07	1301	5787	17.0	432		
27865	28865	30	E2	1.15	29.21	1.41	35.81	1.53	38.86	1560	6939	18.3	465		
27887	28887	40	E2	1.20	30.48	1.54	39.12	1.67	42.42	2020	8985	20.0	508		

BC = Bare Copper • PVC = Polyvinyl Chloride • XLP = Cross-Linked Poly

Dual Rated UL/CSA Control Cables

600 V Teck-Style® Cables: Dual-Rated Type MC/TECK 90

Interlocked Armor



- UL MC
- CSA C22.2 No.131 FT4 Flame Test, HAZ LOC
- CSA C22.2 No. 0.3 Clause 4.31 Low Acid Gas
- Direct Burial

Part No.		Conductors	Color Code	Inner Jacket OD		Armor OD		OD (Nom)		Pull Tension (Max)		Bend Radius (Min)		Insulation Thickness	
Aluminum	Steel			Inch	mm	Inch	mm	Inch	mm	Lbs	N	Inch	mm	Inch	mm

Stranded (7 x 18) BC Conductors • XLP Insulation • PVC Inner Jacket • Interlocked Armor • PVC Outer Jacket

10 AWG • 10 AWG Uninsulated Ground Wire

27866	28866	2	E2	.46	11.68	.65	16.51	.74	18.80	166	738	9.1	231		
27867	28867	3	E2	.48	12.19	.67	17.02	.77	19.56	249	1108	9.4	239		
27868	28868	4	E2	.56	14.22	.75	19.05	.84	21.34	330	1468	10.3	262		
27869	28869	5	E2	.67	17.02	.86	21.84	.96	24.38	415	1846	11.6	295		
27870	28870	6	E2	.67	17.02	.86	21.84	.96	24.38	491	2184	11.6	295		
27877	28877	7	E2	.70	17.78	.90	22.86	1.00	25.40	560	2491	12.1	307		
27878	28878	8	E2	.75	19.05	.95	24.13	1.05	26.67	640	2847	12.7	323	.030	.76
27879	28879	10	E2	.78	19.81	1.04	26.42	1.15	29.21	801	3563	13.8	351		
27880	28880	12	E2	.89	22.61	1.15	29.21	1.26	32.00	960	4270	15.1	384		
27881	28881	15	E2	.93	23.62	1.19	30.23	1.30	33.02	1195	5316	15.6	396		
27882	28882	20	E2	1.06	26.92	1.32	33.53	1.44	36.58	1600	7117	17.3	439		
27883	28883	25	E2	1.12	28.45	1.44	36.58	1.58	40.13	1990	8852	19.0	483		
27884	28884	30	E2	1.28	32.51	1.54	39.12	1.67	42.42	2355	10476	20.0	508		

Stranded (7 x 16) BC Conductors • XLP Insulation • PVC Inner Jacket • Interlocked Armor • PVC Outer Jacket

8 AWG • 10 AWG Uninsulated Ground Wire

27871	28871	2	M4	.59	14.99	.78	19.81	.89	22.61	264	1174	10.7	272		
27872	28872	3	M4	.62	15.75	.81	20.57	.91	23.11	396	1762	10.9	277	.045	1.14
27873	28873	4	M4	.68	17.27	.94	23.88	1.05	26.67	528	2349	12.6	320		

Stranded (7 x 14) BC Conductors • XLP Insulation • PVC Inner Jacket • Interlocked Armor • PVC Outer Jacket

6 AWG • 8 AWG Uninsulated Ground Wire

27874	28874	2	M4	.71	18.03	.97	24.64	1.08	27.43	420	1868	13.0	330		
27875	28875	3	M4	.76	19.30	1.02	25.91	1.13	28.70	630	2802	13.5	343	.060	1.52
27876	28876	4	M4	.88	22.35	1.14	28.96	1.25	31.75	840	3737	15.0	381		

Stranded (7 x 12) BC Conductors • XLP Insulation • PVC Inner Jacket • Interlocked Armor • PVC Outer Jacket

4 AWG • 8 AWG Uninsulated Ground Wire

27894	28894	3	M4	.91	23.11	1.17	29.72	1.29	32.77	1002	4457	15.5	394	.060	1.52
27895	28895	4	M4	.99	25.15	1.25	31.75	1.37	34.80	1335	5938	16.4	417		

Stranded (7 x 11) BC Conductors • XLP Insulation • PVC Inner Jacket • Interlocked Armor • PVC Outer Jacket

3 AWG • 6 AWG Uninsulated Ground Wire

27896	28896	3	M4	.96	24.38	1.22	30.99	1.33	33.78	1263	5618	16.0	406	.060	1.52
-------	-------	---	----	-----	-------	------	-------	------	-------	------	------	------	-----	------	------

Stranded (7 x 10) BC Conductors • XLP Insulation • PVC Inner Jacket • Interlocked Armor • PVC Outer Jacket

2 AWG • 6 AWG Uninsulated Ground Wire

27888	28888	3	M4	1.08	27.43	1.28	32.51	1.40	35.56	1593	7086	16.8	427	.060	1.52
27889	28889	4	M4	1.12	28.45	1.38	35.05	1.50	38.10	2124	9448	18.0	457		

BC = Bare Copper • PVC = Polyvinyl Chloride • XLP = Cross-Linked Poly

Dual Rated UL/CSA Control Cables

600 V Teck-Style® Cables: Dual-Rated Type MC/TECK 90

Interlocked Armor • Composite Cables



- UL MC
- CSA C22.2 No.131 FT4 Flame Test, HAZ LOC
- CSA C22.2 No. 0.3 Clause 4.31 Low Acid Gas
- Direct Burial

Part No.		Conductors	Color Code	Inner Jacket OD		Armor OD		OD (Nom)		Pull Tension (Max)		Bend Radius (Min)		Insulation Thickness	
Aluminum	Steel			Inch	mm	Inch	mm	Inch	mm	Lbs	N	Inch	mm	Inch	mm

Stranded (7 x 22 and 7 x 20) BC Conductors • XLP Insulation • PVC Inner Jacket • Interlocked Armor • PVC Outer Jacket

14 AWG and 12 AWG • 12 AWG Uninsulated Ground Wire

27890	28890	3 + 3	Note 1:	.56	14.22	.75	19.05	.86	21.84	202	899	10.3	262	.030	.76
-------	-------	-------	---------	-----	-------	-----	-------	-----	-------	-----	-----	------	-----	------	-----

Stranded (7 x 22 and 7 x 18) BC Conductors • XLP Insulation • PVC Inner Jacket • Interlocked Armor • PVC Outer Jacket

14 AWG and 10 AWG • 10 AWG Uninsulated Ground Wire

27891	28891	3 + 3	Note 1:	.61	15.49	.80	20.32	.91	23.11	305	1357	10.9	277	.030	.76
-------	-------	-------	---------	-----	-------	-----	-------	-----	-------	-----	------	------	-----	------	-----

Stranded (7 x 22 and 7 x 16) BC Conductors • XLP Insulation • PVC Inner Jacket • Interlocked Armor • PVC Outer Jacket

14 AWG and 8 AWG • 10 AWG Uninsulated Ground Wire

27892	28892	3 + 3	Note 1:	.70	17.78	.96	24.38	1.07	27.18	435	1935	12.8	325	.030 (14 AWG)	0.76
														.045 (8 AWG)	1.14

Stranded (7 x 22 and 7 x 14) BC Conductors • XLP Insulation • PVC Inner Jacket • Interlocked Armor • PVC Outer Jacket

14 AWG and 6 AWG • 6 AWG Uninsulated Ground Wire

27893	28893	3 + 3	Note 1:	.90	22.86	1.15	29.21	1.26	32.00	655	2914	15.1	384	.030 (14 AWG)	0.76
														.060 (6 AWG)	1.52

Note 1: 14, 12, and 10 AWG use ICEA Table E2 with printed numbers. 8 AWG and larger, use ICEA M4 with printed numbers.

CSA Control and Power Cables
600 V and 1000 V TC/CIC Multi-Conductor Cables

Unshielded



- CEC Part 1, Suitable for Use in Hazardous Locations: Class 1, Zone 2 and Class 2, Division 2
- +90 °C Dry & Wet
- -40 °C Cold Bend
- -25 °C Cold Impact
- CSA C22.2 No. 230 Type TC
- CSA C22.2 No. 239 Type CIC (600 V only)
- CSA C22.2 No. 38 Type TC (1000 V only)
- CSA FT4 70,000 BTU Flame test

Conductors	Part No.					
	14 AWG		12 AWG		10 AWG	
	600 V	1000 V	600 V	1000 V	600 V	1000 V

Unshielded • For Foil Shielding, add “S” as a Suffix to the Part Number

7-Strand BC Conductors • Flame Resistant Cross-Linked Poly Insulation • Uninsulated BC Ground Conductor • Optional Foil Shielding • Flame Resistant PVC Jacket						
2	21500	21300	21550	21350	21600	21400
3	21501	21301	21551	21351	21601	21401
4	21502	21302	21552	21352	21602	21402
5	21503	21303	21553	21353	21603	21403
6	21504	21304	21554	21354	21604	21404
7	21505	21305	21555	21355	21605	21405
8	21506	21306	21556	21356	21606	21406
9	21507	21307	21557	21357	21607	21407
10	21508	21308	21558	21358	21608	21408
11	21509	21309	21559	21359	21609	21409
12	21510	21310	21560	21360	21610	21410
13	21511	21311	21561	21361	21611	21411
14	21512	21312	21562	21362	21612	21412
15	21513	21313	21563	21363	21613	21413
16	21514	21314	21564	21364	21614	21414
17	21515	21315	21565	21365	21615	21415
18	21516	21316	21566	21366	21616	21416
19	21517	21317	21567	21367	21617	21417
20	21518	21318	21568	21368	21618	21418
21	21519	21319	21569	21369	21619	21419
22	21520	21320	21570	21370	21620	21420
23	21521	21321	21571	21371	21621	21421
24	21522	21322	21572	21372	21622	21422
25	21523	21323	21573	21373	21623	21423
26	21524	21324	21574	21374	21624	21424
27	21525	21325	21575	21375	21625	21425
28	21526	21326	21576	21376	21626	21426
29	21527	21327	21577	21377	21627	21427
30	21528	21328	21578	21378	21628	21428
31	21529	21329	21579	21379	21629	21429
32	21530	21330	21580	21380	21630	21430
33	21531	21331	21581	21381	21631	21431
34	21532	21332	21582	21382	21632	21432
35	21533	21333	21583	21383	21633	21433
36	21534	21334	21584	21384	21634	21434
37	21535	21335	21585	21385	21635	21435
38	21536	21336	21586	21386	21636	21436
39	21537	21337	21587	21387	21637	21437
40	21538	21338	21588	21388	21638	21438

BC = Bare Copper • PVC = Polyvinyl Chloride

CSA Control and Power Cables (continued)
600 V and 1000 V TC/CIC Multi-Conductor Cables

Unshielded



- CEC Part 1, Suitable for Use in Hazardous Locations: Class 1, Zone 2 and Class 2, Division 2
- +90 °C Dry & Wet
- -40 °C Cold Bend
- -25 °C Cold Impact
- CSA C22.2 No. 230 Type TC
- CSA C22.2 No. 239 Type CIC (600 V only)
- CSA C22.2 No. 38 Type TC (1000 V only)
- CSA FT4 70,000 BTU Flame test

Conductors	Part No.					
	14 AWG		12 AWG		10 AWG	
	600 V	1000 V	600 V	1000 V	600 V	1000 V

Unshielded • For Foil Shielding, add “S” as a Suffix to the Part Number

7-Strand BC Conductors • Flame Resistant Cross-Linked Poly Insulation • Uninsulated BC Ground Conductor • Optional Foil Shielding • Flame Resistant PVC Jacket						
41	21539	21339	21589	21389	21639	21439
42	21540	21340	21590	21390	21640	21440
43	21541	21341	21591	21391	21641	21441
44	21542	21342	21592	21392	21642	21442
45	21543	21343	21593	21393	21643	21443
46	21544	21344	21594	21394	21644	21444
47	21545	21345	21595	21395	21645	21445
48	21546	21346	21596	21396	21646	21446
49	21547	21347	21597	21397	21647	21447
50	21548	21348	21598	21398	21648	21448

Conductors	Part No.									
	8 AWG		6 AWG		4 AWG		3 AWG		2 AWG	
	600 V	1000 V	600 V	1000 V	600 V	1000 V	600 V	1000 V	600 V	1000 V

Unshielded • For Foil Shielding, add “S” as a Suffix to the Part Number

7-Strand BC Conductors • Flame Resistant Cross-Linked Poly Insulation • Optional Foil Shielding • Flame Resistant PVC Jacket										
2	21650	21450	21653	21453	21656	21456	21659	21459	21662	21462
3	21651	21451	21654	21454	21657	21457	21660	21460	21663	21463
4	21652	21452	21655	21455	21658	21458	21661	21461	21664	21464

Conductors	Part No.									
	1 AWG		1/0 AWG		2/0 AWG		3/0 AWG		4/0 AWG	
	600 V	1000 V	600 V	1000 V	600 V	1000 V	600 V	1000 V	600 V	1000 V

Unshielded • For Foil Shielding, add “S” as a Suffix to the Part Number

19-Strand BC Conductors • Flame Resistant Cross-Linked Poly Insulation • Optional Foil Shielding • Flame Resistant PVC Jacket										
2	21665	21465	21668	21468	21671	21471	21674	21474	21677	21477
3	21666	21466	21669	21469	21672	21472	21675	21475	21678	21478
4	21667	21467	21670	21470	21673	21473	21676	21476	21679	21479

Conductor Color Codes

Conductors	Colors
2	Black, White
3	Black, White, Blue
4	Black, Red, White, Blue
5 or More	Black and Numbered

BC = Bare Copper • PVC = Polyvinyl Chloride

CSA Control Cables
600 V CIC Multi-Conductor Cables

Unshielded



- -40 °C to +90 °C Dry
- -40 °C to +90 °C Wet
- -25 °C Cold Impact
- CSA C22.2 No. 231 Type CIC
- CSA FT4 Flame Test

Part No.	Conductors	Color Code	OD (Nom)		Insulation Thickness		Jacket Thickness	
			Inch	mm	Inch	mm	Inch	mm

Stranded BC Conductors • Stranded BC Drain Wire • Cross-Linked Poly Insulation • Black PVC Jacket

14 AWG • 7 x 22 • Unshielded

22100	2	Blk, Numberd	.367	9.32				
22101	3	Blk, Numberd	.388	9.86				
22102	4	Blk, Numberd	.423	10.74				
22103	5	Blk, Numberd	.462	11.74	.030	.76	.045	1.14
22104	6	Blk, Numberd	.504	12.80				
22105	7	Blk, Numberd	.504	12.80				
22106	8	Blk, Numberd	.576	14.63				
22107	9	Blk, Numberd	.618	15.70				
22108	10	Blk, Numberd	.669	17.00	.030	.76	.060	1.52
22110	12	Blk, Numberd	.689	17.50				
22114	16	Blk, Numberd	.764	19.41				
22118	20	Blk, Numberd	.886	22.50	.030	.76	.080	2.03

12 AWG • 7 x 20 • Unshielded

22120	2	Blk, Numberd	.405	10.29				
22121	3	Blk, Numberd	.429	10.90	.030	.76	.045	1.14
22122	4	Blk, Numberd	.469	11.91				
22123	5	Blk, Numberd	.515	13.08				
22124	6	Blk, Numberd	.591	15.01				
22125	7	Blk, Numberd	.591	15.01				
22126	8	Blk, Numberd	.639	16.23	.030	.76	.060	1.52
22127	9	Blk, Numberd	.687	17.45				
22128	10	Blk, Numberd	.745	18.92				
22130	12	Blk, Numberd	.768	19.51				
22134	16	Blk, Numberd	.893	22.68	.030	.76	.080	2.03
22138	20	Blk, Numberd	.992	25.20				

10 AWG • 7 x 18 • Unshielded

22140	2	Blk, Numberd	.736	18.69	.030	.76	.045	1.14
22141	3	Blk, Numberd	.763	19.38				
22142	4	Blk, Numberd	.839	21.31				
22143	5	Blk, Numberd	.891	22.63				
22144	6	Blk, Numberd	.944	23.98				
22145	7	Blk, Numberd	.944	23.98	.030	.76	.060	1.52
22146	8	Blk, Numberd	.999	25.38				
22147	9	Blk, Numberd	1.074	27.28				
22148	10	Blk, Numberd	1.182	30.02				
22150	12	Blk, Numberd	1.209	30.71				
22152	14	Blk, Numberd	1.255	31.88	.030	.76	.080	2.03
22154	16	Blk, Numberd	1.307	33.20				

BC = Bare Copper • PVC = Polyvinyl Chloride

CSA Control Cables

600 V CIC Multi-Conductor Cables

Unshielded



- -40 °C to +90 °C Dry
- -40 °C to +90 °C Wet
- -25 °C Cold Impact

- CSA C22.2 No. 231 Type CIC
- CSA FT4 Flame Test

Part No.	Conductors	Color Code	OD (Nom)		Insulation Thickness		Jacket Thickness	
			Inch	mm	Inch	mm	Inch	mm

Stranded BC Conductors • Stranded BC Drain Wire • Cross-Linked Poly Insulation • Black PVC Jacket

8 AWG • 7 x 16 • Unshielded

22160	2	Blk, Numbered	.863	21.92				
22161	3	Blk, Numbered	.898	22.81	.045	1.14	.060	1.52
22162	4	Blk, Numbered	.957	24.31				

6 AWG • 7 x 14 • Unshielded

22170	2	Blk, Numbered	.711	18.06	.060	1.52	.060	1.52
22171	3	Blk, Numbered	.756	19.20				

4 AWG • 7 x 12 • Unshielded

22180	2	Blk, Numbered	.800	20.32	.060	1.52	.060	1.52
22181	3	Blk, Numbered	.891	22.63				

BC = Bare Copper • PVC = Polyvinyl Chloride

CSA Control Cables

600 V ACIC and TECK 90 Cables – Overview

Belden TECK 90 and ACIC cables are designed to meet demanding industrial needs by combining rugged durability and corrosion resistance with flexibility and easy handling.

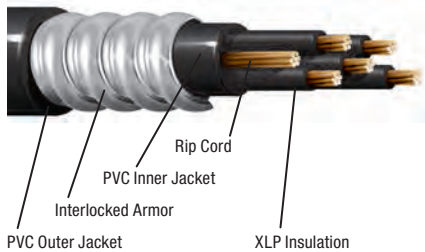

Introduction

TECK 90 and ACIC Cables are available in a wide range of standard and custom constructions to meet the needs of oil and gas, pulp and paper, chemical, petroleum and other demanding industrial and resource industry environments. They are ideal for use in wet or dry areas, ventilated or non-ventilated, ladder-type cable troughs, flexible cableways and direct burial installations.

Belden TECK 90 Cable is marked with "FT4," "HL" designations, and cable constructions are certified to CSA Standard C22.2 No. 131 and C22.2 No. 174 for use in a wide range of hazardous locations. Both inner and outer jackets meet the acid gas evolution requirement of 14% maximum required by CSA Standard C22.2 No. 0.3 Clause 4.31.

Custom cables are available upon request.

Construction

Class B stranded bare copper conductors, cross-link polyethylene insulation, bare copper ground wire, PVC inner jacket, aluminum steel interlocking armor, PVC outer jacket.

- Galvanized steel interlocking armor available as an option.

Voltage Rating

- 18 to 16 AWG – 600 V ACIC
- 14 to 8 AWG – 600 V
- 14 to 4/0 AWG – 1000 V

Temperature Rating

- -40 °C to +90 °C (Dry/Wet)
- -25 °C installed

Application

TECK 90 and ACIC are general-purpose cables used in the oil and gas, pulp and paper, mining, petroleum and chemical industries as well as in commercial buildings.

TECK 90 and ACIC may be used under the following conditions:

- Exposed or concealed wiring in dry or wet conditions
- In ventilated, non-ventilated or ladder-type cable trays in dry or wet conditions
- On walls or beams
- Directly buried
- CEC Class I, Division I locations

Minimum Bending Radius

12 times the overall cable diameter

Pulling Tensions

The combined use of Kellems grips and pulling eyes is recommended.

Design Advantages

Insulation Properties

- High tensile strength
- Impact- and crush-resistant
- Heat-resistant
- Excellent elongation
- Moisture-resistant
- Good low temperature properties

Electrical Properties

- High insulation resistance
- Low dielectric loss
- High dielectric strength

Other Features

- Corrosion-resistant
- Versatile and flexible
- Provides cost savings as conduit and ducts are not required
- ACIC has a blue jacket
- Rip cord for inner jacket

Specifications

- CSA Standard C22.2 No. 131
- CSA Standard C22.2 No. 174 "Cables and Cable Glands for Use in Hazardous Locations"
- CSA Standard C22.2 No. 0.3 Clause 4.31 "Low Acid Gas"
- CSA Standard C22.2 No. 0.3 Clause 4.11.4 "Cables with FT4 Marking"

CSA Control Cables

600 V ACIC Cables

Armored • Unshielded



- CSA C22.2 No. 239 CIC
- CSA C22.2 No. 0.3 Clause 4.31
Low Acid Gas
- HAZ LOC

Part No.	Conductors	Inner Jacket OD		Armor OD		Outer Jacket OD		Pull Tension (Max)		Bend Radius (Min)	
		Inch	mm	Inch	mm	Inch	mm	Lbs	N	Inch	mm

Stranded BC Conductors • Cross-Linked Poly Insulation • Uninsulated BC Ground Wire • PVC Inner Jacket • Armor • Blue PVC Outer Jacket

18 AWG • 7 x 26

29030	2	.32	8.13	.52	13.21	.62	15.75	44	196	7.4	187.96
29031	3	.34	8.64	.54	13.72	.64	16.26	66	294	7.6	193.04
29032	4	.37	9.40	.57	14.48	.67	17.02	88	392	8.0	203.20
29033	5	.41	10.41	.61	15.49	.71	18.03	110	490	8.5	215.90
29034	6	.45	11.43	.65	16.51	.75	19.05	132	587	9.0	228.60
29035	7	.45	11.43	.65	16.51	.75	19.05	154	685	9.0	228.60
29036	8	.48	12.19	.68	17.27	.78	19.81	176	783	9.3	236.22
29038	10	.56	14.22	.76	19.30	.87	22.10	220	979	10.6	269.24
29040	12	.62	15.75	.82	20.83	.93	23.62	264	1175	11.1	281.94
29043	15	.65	16.51	.85	21.59	.96	24.38	330	1469	11.5	292.10
29048	20	.73	18.54	.93	23.62	1.04	26.42	440	1958	12.4	314.96
29053	25	.79	20.07	1.05	26.67	1.16	29.46	550	2448	13.9	353.06
29058	30	.88	22.35	1.14	28.96	1.25	31.75	660	2937	15.0	381.00
29068	40	.97	24.64	1.23	31.24	1.35	34.29	880	3916	16.2	411.48
29078	50	1.09	27.69	1.35	34.29	1.47	37.34	1100	4895	17.6	447.04

16 AWG • 7 x 24

29017	2	.34	8.64	.54	13.72	.65	16.51	70	312	7.7	195.58
29004	3	.36	9.14	.56	14.22	.66	16.76	105	467	7.9	200.66
29018	4	.39	9.91	.59	14.99	.70	17.78	140	623	8.3	210.82
29019	5	.42	10.67	.62	15.75	.73	18.54	175	779	8.6	218.44
29005	6	.46	11.68	.66	16.76	.77	19.56	210	935	9.1	231.14
29020	7	.47	11.94	.67	17.02	.77	19.56	245	1090	9.2	233.68
29021	8	.50	12.70	.70	17.78	.80	20.32	280	1246	9.6	243.84
29022	10	.61	15.49	.81	20.57	.92	23.37	350	1558	10.9	276.86
29006	12	.63	16.00	.83	21.08	.94	23.88	420	1869	11.2	284.48
29023	15	.68	17.27	.88	22.35	1.00	25.40	525	2336	11.9	302.26
29007	20	.77	19.56	1.03	26.16	1.13	28.70	700	3115	13.7	347.98
29024	25	.89	22.61	1.15	29.21	1.26	32.00	875	3894	15.1	383.54
29008	30	.94	23.88	1.20	30.48	1.30	33.02	1050	4673	15.8	401.32
29009	40	1.06	26.92	1.32	33.53	1.41	35.81	1400	6230	17.3	439.42
29016	50	1.19	30.23	1.45	36.83	1.54	39.12	1750	7788	18.8	477.52
29025	60	1.27	32.26	1.53	38.86	1.66	42.16	2100	9345	19.9	505.46

Conductor Color Codes

Conductors	Colors
2	Black, White
3	Black, White, Blue
4	Black, Red, White, Blue
5 or More	Black and Numbered

BC = Bare Copper • PVC = Polyvinyl Chloride

CSA Control Cables
600 V TECK 90 Cables

Armored • Unshielded



- CSA C22.2 No. 239 CIC
- CSA C22.2 No. 0.3 Clause 4.31 Low Acid Gas
- HAZ LOC

Part No.	Conductors	Inner Jacket OD		Armor OD		Outer Jacket OD		Pull Tension (Max)		Bend Radius (Min)	
		Inch	mm	Inch	mm	Inch	mm	Lbs	N	Inch	mm

Stranded BC Conductors • Cross-Linked Poly Insulation • Uninsulated BC Ground Wire • PVC Inner Jacket • Armor • Black PVC Outer Jacket

14 AWG • 7 x 22

C5500	2	.36	9.14	.56	14.22	.66	16.76	108	481	7.8	198.12
C5501	3	.39	9.91	.58	14.73	.66	16.76	162	721	8.2	208.28
C5502	4	.42	10.67	.62	15.75	.71	18.03	216	961	8.5	215.90
C5503	5	.47	11.94	.66	16.76	.74	18.80	270	1202	9.0	228.60
C5504	6	.51	12.95	.70	17.78	.78	19.81	324	1442	9.5	241.30
C5505	7	.51	12.95	.70	17.78	.78	19.81	378	1682	9.5	241.30
C5506	8	.58	14.73	.77	19.56	.86	21.84	432	1922	10.4	264.16
C5508	10	.67	17.02	.93	23.62	.95	24.13	540	2403	12.3	312.42
C5510	12	.69	17.53	.95	24.13	.97	24.64	648	2884	12.6	320.04
C5513	15	.77	19.56	1.03	26.16	1.11	28.19	810	3605	14.1	358.14
C5518	20	.90	22.86	1.16	29.46	1.24	31.50	1080	4806	15.1	383.54
C5523	25	.90	22.86	1.24	31.50	1.33	33.78	1350	6008	16.1	408.94
C5528	30	1.05	26.67	1.30	33.02	1.40	35.56	1620	7209	16.8	426.72
C5529	40	1.20	30.48	1.42	36.07	1.51	38.35	2160	9612	18.3	464.82
C6064	50	1.35	34.29	1.60	40.64	1.66	42.16	2700	12,015	20.5	520.70

12 AWG • 7 x 20

C5530	2	.41	10.41	.60	15.24	.69	17.53	172	765	8.3	210.82
C5531	3	.43	10.92	.62	15.75	.70	17.78	258	1148	8.6	218.44
C5532	4	.47	11.94	.66	16.76	.73	18.54	344	1531	9.1	231.14
C5533	5	.52	13.21	.71	18.03	.78	19.81	430	1914	9.1	231.14
C5534	6	.59	14.99	.78	19.81	.86	21.84	516	2296	10.5	266.70
C5535	7	.59	14.99	.78	19.81	.86	21.84	602	2679	10.5	266.70
C5536	8	.64	16.26	.83	21.08	.92	23.37	688	3062	11.1	281.94
C5538	10	.75	19.05	1.01	25.65	1.02	25.91	860	3827	13.3	337.82
C5540	12	.77	19.56	1.03	26.16	1.12	28.45	1032	4592	13.5	342.90
C5543	15	.90	22.86	1.16	29.46	1.24	31.50	1290	5741	15.1	383.54
C5548	20	.99	25.15	1.25	31.75	1.34	34.04	1720	7654	16.5	419.10
C5553	25	1.10	27.94	1.36	34.54	1.45	36.83	2150	9568	17.6	447.04
C5558	30	1.20	30.48	1.46	37.08	1.51	38.35	2580	11,481	17.6	447.04

Conductor Color Codes

Conductors	Colors
2	Black, White
3	Black, White, Blue
4	Black, Red, White, Blue
5 or More	Black and Numbered

BC = Bare Copper • PVC = Polyvinyl Chloride

CSA Control Cables
600 V TECK 90 Cables

Armored • Unshielded



- CSA C22.2 No. 239 CIC
- CSA C22.2 No. 0.3 Clause 4.31
Low Acid Gas
- HAZ LOC

Part No.	Conductors	Inner Jacket OD		Armor OD		Outer Jacket OD		Pull Tension (Max)		Bend Radius (Min)	
		Inch	mm	Inch	mm	Inch	mm	Lbs	N	Inch	mm

Stranded BC Conductors • Cross-Linked Poly Insulation • Uninsulated BC Ground Wire • PVC Inner Jacket • Armor • Black PVC Outer Jacket

10 AWG • 7 x 18

C5560	2	.48	12.19	.66	16.76	.72	18.29	296	1317	8.9	226.06
C5561	3	.50	12.70	.70	17.78	.75	19.05	444	1976	9.2	233.68
C5562	4	.57	14.48	.77	19.56	.79	20.07	592	2634	10.1	256.64
C5563	5	.63	16.00	.83	21.08	.93	23.62	740	3293	11.5	292.10
C5564	6	.68	17.27	.88	22.35	.93	23.62	888	3952	11.5	292.10
C5565	7	.69	17.53	.89	22.61	.99	25.15	1036	4610	11.8	299.72
C5566	8	.74	18.80	.94	23.88	1.00	25.40	1184	5269	12.4	314.96
C5568	10	.84	21.34	1.10	27.94	1.24	31.50	1480	6586	14.4	365.76
C5570	12	.93	23.62	1.19	30.23	1.26	32.00	1776	7903	15.6	396.24
C5573	15	.99	25.15	1.25	31.75	1.37	34.80	2220	9879	16.3	414.02
C5578	20	1.13	28.70	1.39	35.31	1.47	37.34	2960	13,172	16.9	429.26
C5579	25	1.26	32.00	1.52	38.61	1.60	40.64	3700	16,465	19.7	500.38
C5580	30	1.34	34.04	1.60	40.64	1.66	42.16	4440	19,758	20.6	523.24

8 AWG • 7 x 16

C5583	2	.59	14.99	.78	19.81	.86	21.84	384	1709	10.6	269.24
C5581	3	.63	16.00	.83	21.08	.90	22.86	576	2563	10.8	274.32
C5582	4	.69	17.53	.89	22.61	.97	24.64	768	3418	12.5	317.50

Conductor Color Codes

Conductors	Colors
2	Black, White
3	Black, White, Blue
4	Black, Red, White, Blue
5 or More	Black and Numbered

CSA Control Cables
600 V TECK 90 Composite Cables

Composite • Armored • Unshielded



- Sunlight Res
- CSA C22.2 No. 131 Type TECK 90
- CSA C22.2 No. 0.3 Clause 4.31 Low Acid Gas
- HAZ LOC

Part No.	Conductors	Color Code	Inner Jacket OD		Armor OD		Outer Jacket OD		Pull Tension (Max)		Bend Radius (Min)	
			Inch	mm	Inch	mm	Inch	mm	Lbs	N	Inch	mm

Stranded BC Conductors • Cross-linked Poly Insulation • PVC Inner Jacket • Armor • Black PVC Outer Jacket

14 and 12 AWG • 7 x 22 and 7 x 20 • 14 AWG Uninsulated Ground Wire

6054	3 + 3	E2	.560	14.22	.75	19.05	.89	22.61	424	1886	8.4	213.36
------	-------	----	------	-------	-----	-------	-----	-------	-----	------	-----	--------

14 and 10 AWG • 7 x 22 and 7 x 18 • 12 AWG Uninsulated Ground Wire

6051	3 + 3	E2	.600	15.24	.82	20.83	.92	23.37	608	2705	9.0	228.60
------	-------	----	------	-------	-----	-------	-----	-------	-----	------	-----	--------

14 and 8 AWG • 7 x 22 and 7 x 16 • 10 AWG Uninsulated Ground Wire

6059	3 + 3	E2	.700	17.78	.89	22.51	.98	24.92	1160	5160	9.8	248.92
------	-------	----	------	-------	-----	-------	-----	-------	------	------	-----	--------

14 and 6 AWG • 7 x 22 and 7 x 14 • 8 AWG Uninsulated Ground Wire

6060	3 + 3	E2	.810	20.57	1.06	27.00	1.16	29.41	1700	7562	11.6	294.64
------	-------	----	------	-------	------	-------	------	-------	------	------	------	--------

BC = Bare Copper • PVC = Polyvinyl Chloride

CSA Control Cables
1000 V TECK 90 Cables

Armored • Unshielded



- CSA C22.2 No. 131 Type TECK 90
- CSA C22.2 No. 0.3 Clause 4.31
Low Acid Gas
- HAZ LOC

Part No.	Conductors	Inner Jacket OD		Armor OD		Outer Jacket OD		Pull Tension (Max)		Bend Radius (Min)	
		Inch	mm	Inch	mm	Inch	mm	Lbs	N	Inch	mm

Stranded BC Conductors • Cross-linked Poly Insulation • PVC Inner Jacket • Armor • Black PVC Outer Jacket

14 AWG • 7 x 22 • 14 AWG Uninsulated Ground Wire

C5701	3	.47	11.94	.67	17.02	.73	18.54	162	721	9.2	233.68
C5702	4	.51	12.95	.71	18.03	.81	20.57	216	961	9.7	246.38

12 AWG • 7 x 20 • 14 AWG Uninsulated Ground Wire

C5730	2	.48	12.19	.68	17.27	.74	18.80	172	765	9.3	236.22
C5731	3	.51	12.95	.71	18.03	.76	19.30	258	1148	9.7	246.38
C5732	4	.59	14.99	.75	19.05	.85	21.59	344	1531	10.8	274.32

10 AWG • 7 x 18 • 12 AWG Uninsulated Ground Wire

C5760	2	.56	14.22	.79	19.99	.70	17.71	296	1317	10.3	261.62
C5761	3	.59	14.99	.79	20.07	.85	21.59	444	1976	10.3	261.62
C5762	4	.65	16.51	.85	21.59	.90	22.86	592	2634	11.5	292.10

8 AWG • 7 x 16 • 10 AWG Uninsulated Ground Wire

C5583	2	.59	14.99	.78	19.81	.86	21.84	384	1709	10.6	269.24
C5581	3	.63	16.00	.83	21.08	.90	22.86	576	2563	10.8	274.32
C5582	4	.69	17.53	.89	22.61	.97	24.64	768	3418	12.5	317.50

6 AWG • 7 x 14 • 8 AWG Uninsulated Ground Wire

C5590	2	.73	18.54	.99	25.15	1.10	27.94	610	2713	12.8	325.12
C5591	3	.78	19.81	1.04	26.42	1.15	29.21	915	4072	13.4	340.36
C5592	4	.89	22.61	1.15	29.21	1.24	31.50	1220	5429	14.9	378.46

Conductor Color Codes

Conductors	Colors
2	Black, White
3	Black, White, Blue
4	Black, Red, White, Blue

CSA Control Cables
1000 V TECK 90 Cables

Armored • Unshielded



- CSA C22.2 No. 131 Type TECK 90
- CSA C22.2 No. 0.3 Clause 4.31 Low Acid Gas
- HAZ LOC

Part No.	Conductors	Inner Jacket OD		Armor OD		Outer Jacket OD		Pull Tension (Max)		Bend Radius (Min)	
		Inch	mm	Inch	mm	Inch	mm	Lbs	N	Inch	mm

Stranded BC Conductors • Cross-linked Poly Insulation • PVC Inner Jacket • Armor • Black PVC Outer Jacket

4 AWG • 7 x 12 • 8 AWG Uninsulated Ground Wire

C5601	3	.91	23.11	1.17	29.72	1.23	31.24	1455	6475	15.2	386.08
C5602	4	.91	23.11	1.25	31.75	1.33	33.78	1940	8633	16.2	411.48

3 AWG • 7 x 11 • 6 AWG Uninsulated Ground Wire

C5611	3	.97	24.64	1.23	31.24	1.30	33.02	1836	8170	15.8	401.32
--------------	---	-----	-------	------	-------	------	-------	------	------	------	--------

2 AWG • 7 x 10 • 6 AWG Uninsulated Ground Wire

C5621	3	1.02	25.91	1.28	32.51	1.37	34.80	2316	10,302	16.5	419.10
C5622	4	1.12	28.45	1.38	35.05	1.48	37.59	3088	13,736	17.7	449.58

1 AWG • 19 x 14 • 6 AWG Uninsulated Ground Wire

C5625	3	1.25	31.75	1.51	38.35	1.59	40.39	1980	8807	19.1	485.14
C5626	4	1.34	34.04	1.57	39.88	1.68	42.67	2680	11,921	20.2	513.08

1/0 AWG • 19 x 12 • 6 AWG Uninsulated Ground Wire

C5627	3	1.34	34.04	1.60	40.64	1.67	42.42	3582	15,940	20.0	508.0
6164	4	1.44	36.58	1.67	42.42	1.78	45.21	4700	20,906	21.4	543.56

2/0 AWG • 19 x 11 • 6 AWG Uninsulated Ground Wire

C5635	3	1.40	35.56	1.63	41.40	1.74	44.20	4200	12010	20.9	530.86
6157	4	1.55	39.37	1.84	46.74	1.95	49.53	5500	24,465	23.4	594.36

3/0 AWG • 19 x 10 • 4 AWG Uninsulated Ground Wire

6163	3	1.51	38.10	1.80	45.72	1.91	48.26	5020	11,121	22.9	579.12
6179	4	1.67	42.42	1.96	49.78	2.07	52.58	6500	28,913	24.8	629.92

4/0 AWG • 19 x 9.5 • 4 AWG Uninsulated Ground Wire

6193	3	1.63	41.40	1.92	48.77	2.03	51.56	6650	29,580	24.4	619.76
-------------	---	------	-------	------	-------	------	-------	------	--------	------	--------

Conductor Color Codes

Conductors	Colors
3	Black, White, Blue
4	Black, Red, White, Blue

BC = Bare Copper • PVC = Polyvinyl Chloride

Technical Information
Gland Information for Armored Cables

Thomas and Betts

Part No.	Hub Size NPT	Range Over Jacket			
		Minimum		Maximum	
		Inch	mm	Inch	mm
ST050-462	1/2	.525	13.34	.650	16.51
ST050-464	1/2	.600	15.24	.760	19.30
ST050-465	1/2	.725	18.42	.885	22.48
ST050-466	1/2	.825	20.96	.985	25.02
ST075-467	3/4	.880	22.35	1.065	27.05
ST075-468	3/4	1.025	26.04	1.205	30.61
ST100-469	1	1.187	30.15	1.375	34.93
ST125-470	1-1/4	1.350	34.29	1.625	41.28
ST125-550	1-1/4	1.500	38.10	1.625	41.28
ST125-471	1-1/4	1.600	40.64	1.875	47.63
ST150-472	1-1/2	1.700	43.18	1.965	49.91
ST150-473	1-1/2	1.900	48.26	2.187	55.55
ST200-551	2	1.900	48.26	2.187	55.55
ST200-474	2	2.100	53.34	2.375	60.33
ST200-475	2	2.300	58.42	2.565	65.15
ST200-476	2	2.500	63.50	2.750	69.85
ST250-477	2-1/2	2.380	60.45	2.640	67.06
ST250-478	2-1/2	2.580	65.53	2.840	72.14
ST300-479	3	2.790	70.87	3.060	77.72
ST300-480	3	3.000	76.20	3.270	83.06
ST300-481	3	3.210	81.53	3.480	88.39
ST350-482	3-1/2	3.420	86.67	3.690	93.73
ST350-483	3-1/2	3.610	91.69	3.870	98.30
ST400-484	4	3.810	96.77	4.030	102.36
ST400-485	4	3.965	100.71	4.185	106.30
ST400-486	4	4.120	104.65	4.340	110.24

Crouse Hinds

NPT Thread Size	Armor OD Range (Inch)	Non-Hazardous Part No.	Hazardous Part No.
1/2	.440 to .650	TMC165	TMCX165*
3/4	.600 to .850	TMC285	TMCX285*
1	.800 to 1.120	TMC3112	TMCX3112*
1-1/4	1.100 to 1.400	TMC4140	TMCX4140*
1-1/2	1.330 to 1.610	TMC5161	TMCX5161*
2	1.570 to 2.060	TMC6206	TMCX6206
2-1/2	1.930 to 2.470	TMC7247	TMCX7247*
3	2.450 to 3.020	TMC8302	TMCX8302
3-1/2	2.950 to 3.520	TMC9352	TMCX9352
4	3.500 to 4.020	TMC10402	TMCX10402

* TMCX Catalog numbers listed are suitable for use with Type TC tray cable in hazardous locations when installed in accordance with NEC Articles 501-5(e) and 502-5. TMCX series is not suitable for use in Class III locations when used with tray cable.

Hawke Size Ref.	Standard Seal 1348 Diameter				Alternative Seal 1498 Diameter				NPT Size
	Minimum		Maximum		Minimum		Maximum		
	Inch	mm	Inch	mm	Inch	mm	Inch	mm	
711-A	.590	14.99	.820	20.83	.470	11.94	.610	15.49	1/2
711-B	.790	20.07	.060	26.92	.630	16.00	.840	21.34	3/4
711-C	.930	23.62	1.310	33.27	.830	21.08	1.090	27.69	1
711-C2	1.260	32.00	1.690	42.93	1.100	27.94	1.340	34.04	1-1/4
711-D	1.690	42.93	2.060	52.32	1.300	33.02	1.610	40.89	2
711-E	2.050	52.07	2.560	65.02	1.810	45.97	2.160	54.86	2-1/2
711-F	2.560	65.02	3.070	77.98	2.240	56.90	2.640	67.06	3
711-H	2.990	75.95	3.520	89.41	Special Order				3-1/2
711-J	3.500	88.90	4.110	104.39	Special Order				4

Adalet - PLM

Part No.	Diameter Over Jacket				Conduit Size
	Minimum		Maximum		
	Inch	mm	Inch	mm	
PS/PSX 45-05	.350	8.89	.450	11.43	1/2
PS/PSX 55-05	.450	11.43	.550	13.97	1/2
PS/PSX 65-05	.550	13.97	.650	16.51	1/2
PS/PSX 75-05	.650	16.51	.750	19.05	1/2
PS/PSX 85-05	.750	19.05	.850	21.59	1/2
PS/PSX 95-05	.850	21.59	.950	24.13	1/2
PS/PSX 99-07	.850	21.59	.990	25.15	3/4
PS/PSX 107-07	.920	23.37	1.070	27.18	3/4
PS/PSX 113-07	.980	24.89	1.130	28.70	3/4
PS/PSX 121-07	1.070	27.18	1.210	30.73	3/4
PS/PSX 112-10	1.000	25.40	1.120	28.45	1
PS/PSX 125-10	1.120	28.45	1.250	31.25	1
PS/PSX 138-10	1.220	30.99	1.380	35.05	1
PS/PSX 138-12	1.280	32.51	1.380	35.05	1-1/4
PS/PSX 156-12	1.380	35.05	1.560	39.62	1-1/4
PS/PSX 174-12	1.560	39.62	1.740	44.20	1-1/4
PS/PSX 188-12	1.740	44.20	1.880	47.75	1-1/4
PS/PSX 174-15	1.600	40.64	1.740	44.20	1-1/2
PS/PSX 188-15	1.740	44.20	1.880	47.75	1-1/2
PS/PSX 200-15	1.880	47.75	2.000	50.80	1-1/2
PS/PSX 218-15	2.000	50.80	2.180	55.37	1-1/2
PS/PSX 219-20	2.050	52.07	2.190	55.63	2
PS/PSX 236-20	2.190	55.63	2.360	59.94	2
PS/PSX 247-20	2.350	59.69	2.470	62.74	2
PS/PSX 261-20	2.470	62.74	2.610	66.29	2
PS/PSX 263-25	2.460	62.48	2.630	66.80	2-1/2
PS/PSX 280-25	2.620	66.55	2.800	71.12	2-1/2
PS/PSX 296-25	2.800	71.12	2.960	75.18	2-1/2
PS/PSX 297-30	2.800	71.12	2.970	75.44	3
PS/PSX 311-30	2.950	74.93	3.110	78.99	3
PS/PSX 327-30	3.100	78.74	3.270	83.06	3
PS/PSX 343-30	3.260	82.80	3.430	87.12	3
PS/PSX 359-30	3.420	86.87	3.590	91.19	3
PS/PSX 375-35	3.520	89.41	3.750	95.25	3-1/2
PS/PSX 392-35	3.750	95.25	3.920	99.57	3-1/2
PS/PSX 412-35	3.900	99.06	4.120	104.65	3-1/2
PS/PSX 423-40	4.050	102.87	4.230	107.44	4
PS/PSX 437-40	4.200	106.68	4.370	111.00	4
PS/PSX 451-40	4.340	110.24	4.510	114.55	4
PS/PSX 462-40	4.430	112.52	4.620	117.35	4

** Use PS for non-hazardous locations and PSX for hazardous locations.

Technical Information

LSZH Jacketed Cables and Hazardous Locations Reference

Approvals and Standards/Performance Data for Low-Smoke, Zero-Halogen Jacketed Cable

XLP Insulation

Physical: (per UL-44)			
Tensile (min)	1500 psi	Deformation (max)	3.35
Elongation (min)	150%	LOI	27

	Haloarrest®	HaloarrestXLink-1	HaloarrestXLink-2
Physical			
Tensile (min)	1500 psi	1500 psi	1500 psi
Elongation (min)	100%	150%	150%
Tear Resistance	74 lbs/inch	—	—
LOI	38	39	45
Halogen Content			
IEC 754-1	0%	0%	0%
BS6425	0%	—	—
MIL-C-24643	<0.2%	—	—
NBS Smoke Chamber			
Flaming Mode	141 D _m corrected typical	164 D _m corrected typical	—
Smoldering Mode	311 D _m corrected typical	417 D _m corrected typical	—
Acid Gas			
IEC 754-2	4.3 pH, 28 μS/cm	4.9 pH, 0.7 μS/cm	<4.5 pH, 0.4 μS/cm
VDE 0472 Part 813	4.3 pH, 27 μS/cm	—	—
Toxicity Index			
NES 713	1	4.6	—
EN50305-2	—	—	2

Low-Smoke, Zero-Halogen Jacketed Cable Specifications

600 V, +90 °C TC-LC NEC 340/UL 1277 & 1685

Instrumentation

- 18 to 12 AWG, BC or TC
- +90 °C XLP insulation
- UL 44 XHHW-2 – +90 °C dry/wet
- Shielded or unshielded
- Haloarrest® jacket

Control or Power

- 14 to 4/0 AWG, BC or TC
- +90 °C XLP insulation
- UL 44 XHHW-2 – +90 °C dry/wet
- Shielded or unshielded
- Haloarrest® jacket

Hazardous Locations Cable Reference

Article 500

Class I Division 1 Hazards

- Locations where flammable gases or vapors may exist under normal operating conditions, under frequent repair or maintenance operations, or where break-down or faulty operation of process equipment might also cause simultaneous failure of electrical equipment.
- Use conduit or MI cable with approved termination fittings.

Class I Division 2 Hazards

- Locations where flammable gases, vapors or volatile liquids are handled either in a closed system, or confined within suitable enclosures, or where hazardous concentrations are normally prevented by positive mechanical ventilation. Areas adjacent to Division 1 areas belong in Division 2.
- Use PLTC, ITC, TC, MC, MV, MI with approved termination fittings.

Class II Division 1

- Locations where combustible dusts exist under normal conditions.
- Use conduit or MI with approved termination fittings.

Class II Division 2

- Locations where combustible dusts exist under abnormal conditions.
- Use conduit or PLTC, ITC, TC, MC with ventilated channel cable trays.
- Use conduit or MC, MI with approved termination fittings.

Class III Division 1

- Locations where easily ignitable fibers and flyings exist under normal conditions.
- Use conduit or MC, MI with approved termination fittings.

Class III Division 2

- Locations where easily ignitable fibers and flyings exist under abnormal conditions.
- Use conduit or MC, MI with approved termination fittings.

Article 504

Intrinsically Safe

- Equipment and wiring that are incapable of releasing sufficient electrical energy under normal or abnormal conditions to cause ignition of a specific hazardous atmospheric mixture in its most easily ignited concentration.
- Use CL3, CL2, PLTC, TC or CM cable, colored light blue, with approved sealing and separation.

Hazardous Location Cable Reference per Canadian Electrical Code CEC Section 18

All Armored cables printed "HL" per CSA C22.2 #174 are rated for all Hazardous Location Classes and Divisions (i.e., Class 1, Div. 1).

All Tray Cables printed "TC" per CSA C22.2 #230 are rated for all Hazardous Location Classes and Division 2 or lower. (i.e., Class 1, Div. 2 or lower).

Technical Information

UL Approved Insulation/Jacketing Options

Insulation/Jacket	UL Listed for MC and TC		Flame Tests
	Max. Temp Rating		
	Wet	Dry	
PVC-Nylon/PVC (THHN or THWN) 14 AWG & larger	+75 °C	+90 °C	UL 1685 FT4/ IEEE 1202/383 ICEA T-29-520
PVC-Nylon/PVC (TFN or TFFN) 16 & 18 AWG	+75 °C	+90 °C	UL 1685 FT4/ IEEE 1202/383 ICEA T-29-520
XLP/PVC or CPE (XHHW-2) 14 AWG & larger	+90 °C	+90 °C	UL 1685 FT4/ IEEE 1202/383 VW-1 rated singles ICEA T-29-520
XLP/PVC or CPE (RFH-2) 16 & 18 AWG	+90 °C	+90 °C	UL 1685 FT4/ IEEE 1202/383 VW-1 rated singles ICEA T-29-520
FRPO/PVC 18 AWG & larger	—	+75 °C	UL 1685
FRPO/PVC	+75 °C	+90 °C	UL 1685
XLP/Haloarrest® (XHHW-2) 14 AWG & larger	+90 °C	+90 °C	UL 1685
XLP/Haloarrest (RFH-2) 16 & 18 AWG	+90 °C	+90 °C	UL 1685 ICEA T-29-520
XLP/HaloarrestXLink™-1 (XHHW-2) 18 AWG & larger	+90 °C	+90 °C	UL 1685 FT4/IEEE 1202/383 VW-1 rated singles
XLP/HaloarrestXLink-2 (XHHW-2) 18 AWG & larger	+90 °C	+90 °C	UL 1685 FT4/IEEE 1202/383 VW-1 rated singles
FEP/PVC	+90 °C	+90 °C	UL 1685

UL Listed for PLTC	
Insulation/Jacket	Max. Temp Rating
XLP/PVC	+90 °C
XLP/CPE	+90 °C
PVC/PVC	+105 °C
PVC/CPE	+105 °C
PE/PVC	+75 °C
FPE/PVC	+75 °C
XLP/Haloarrest	+90 °C
FEP/FEP	+200 °C

Abbreviations Key	
CPE	Chlorinated Polyethylene
FEP	Fluorinated Ethylene-propylene
FPE	Foam Polyethylene
FRPO	Flame-Retardant Polyolefin
PE	Polyethylene
PVC	Polyvinyl Chloride Nylon insulated singles are type THHN or THWN for conductors 14 AWG or larger. Conductor sizes 16 and 18 AWG are Type TFN or TFFN singles.
XLP	Cross-Linked Poly Cross-Linked Poly (XLP) insulated singles are type XHHW-2 for conductors 14 AWG or larger. Conductor sizes 16 and 18 AWG are RFH-2.

Vertical Tray Flame Test Comparison

Test	UL 1685 (UL 1581)	FT4/IEEE 1202/ IEEE 383-2003	IEEE 383-1974	IEC 60332-3	ICEA T-29-520
Flame Test Chamber	Vertical Tray	Vertical Tray	Vertical Tray	Vertical Tray	Vertical Tray
Burner Type	Ribbon gas burner	Ribbon gas burner	Ribbon gas burner	Ribbon gas burner	Ribbon gas burner
Theoretical Heat Input	70,000 BTU/hr	70,000 BTU/hr	70,000 BTU/hr	70,000 BTU/hr	210,000 BTU/hr
Burner Positioning	horizontal 3" (8 cm) from samples 18" (46 cm) from tray base	+20 °C up from horizontal 2.95" (7.5 cm) from cable surface 11.8" (30 cm) above floor	horizontal 3" (8 cm) from samples 18" (46 cm) above tray bottom	horizontal 2.95" (7.5 cm) from cable surface 23.6" (60 cm) above floor	horizontal 8-1/4" (20-3.6 cm) from cable surface 12-1/4" (30-3.6 cm) above tray base
Tray Dimensions	8' (2.4 m) length, 12" (30 cm) width, 3" (8 cm) side flanges	9.84' (3 m) length, 11.81" (30 cm) width, 2.85" (7 cm) side flanges	8' (2.4 m) length, 12" (30 cm) width, 3" (8 cm) side flanges	11.5' (3.5 m) length, 19.7" (50 cm) width, side flanges: none	8' (2.4 m) length, 12" (30 cm) width, 3" (8 cm) side flanges
Sample Spacing	1/2 cable diameter	1/2 cable diameter	1/2 cable diameter	lesser of 1/2 cable diameter and .78" (2 cm)	1/2 cable diameter
Duration of Flame Application	20 minutes	20 minutes	20 minutes	20 minutes	20 minutes
Mode of Failure	Cable blistering or charring has reached the top of the sample after the cable has self-extinguished.	Cable char has exceeded a length of 4.92' (1.5 m).	Cable blistering or charring has reached the top of the sample after the cable has self-extinguished.	Cable charring has reached a height of 98.4" (250 cm) above the bottom of the burner.	Cable blistering or charring has reached the top of the sample after the cable has self-extinguished.



Power & Control Paired and Triads Cables

Section Table of Contents

Power & Control	Page
Paired and Triads Cables	
Overview	76
Classic Paired Cables	77
Overview and Selection Guide	77–84
Special Audio, Communication and Instrumentation Cables	85–86
Audio, Control, and Instrumentation Cables	87–103
UL Instrumentation Cables	104
300 V Power-Limited Tray Cables	104–118
Thermocouple Extension Cable and Thermocouple Wire	119–121
600 V Tray Cables	122–131
CSA Instrumentation and Thermocouple Tray Cables	132
300 V TC/CIC	132–133
CSA Instrumentation Cables	134
300 V CIC	134–135
300 V ACIC Armored Cables	136–138



Paired and Triads Cables



Belden's Paired and Triads cable line includes a select number of high quality, high-reliability cables that meet or exceed UL standards and have been used worldwide for decades.

Belden's Classic paired cables offer one of the broadest lines of UL Listed, NEC and CEC cables available from any single source. Due to the improved noise immunity of twisted pairs, these designs generally permit higher data speeds than traditional multiconductor cables.

The Belden Instrumentation product line consists of 300 V Power Limited Tray (PLTC) instrumentation cables, thermocouple instrumentation cables, thermocouple extension cables and wire, and 600 V TC instrumentation cables, which comply with ICEA standards, TC-ER and TC-LS ratings.

Product Features

- Cable jackets are resistant to sunlight, moisture and vapor penetration
- Robust designs that meet or exceed UL standards, PLTC-ER, ITC-ER, TC-ER and NFPA rated
- Broad range of AWG sizes, shielding options, and pair counts
- Constructions with PVC/PVC that have three or more conductors and 20 AWG or larger conductors
- Insulation/jacket options to include XLP/PVC, XLP/CPE, PVC/PVC, PVC/CPE, XLP/Haloarrest, FEP/FEP
- Armoring capabilities to include interlock or continuous armor and Belclad® corrugated protective metal tapes

Benefits

- Product Consistency – by manufacturing our products in ISO-certified, state-of-the-art manufacturing facilities, Belden assures that quality is built into each and every product.
- Product Reliability – even in the harshest of environments – is the hallmark of Belden Instrumentation cables. No matter what type of insulation, conductor count, gauge size, jacket, armor or rating we can meet your needs.

Applications

Belden Classics paired products deliver low voltage analog data signals within enclosures, from controllers and I/Os to devices such as temperature and pressure sensors, relays, valves, meters, actuators, and alarms. They also are applicable for computers, communications, instrumentation, sound, control, audio, data transmission, and many more applications.

The Belden Instrumentation cables are available with multiple armoring and jacketing options – making them ideal for all industries, including petrochemical, pharmaceutical, mining, power generation, wastewater treatment, pulp and paper, food processing, and transportation.



Classic Paired Cables

Belden's Classic paired cable line includes a select number of high-quality, high-reliability cables that meet or exceed UL standards and have been used worldwide for decades.

Belden paired products deliver low voltage analog data signals within enclosures, from controllers and I/Os to devices such as temperature and pressure sensors, relays, valves, meters, thermocouples, solenoids, actuators, contacts, push buttons, and alarms. They also are applicable for computers, communications, instrumentation, sound, control, audio, data transmission, and many more applications.

- Unsurpassed quality and reliability
- Robust designs that meet or exceed UL standards
- Proven performance in installations worldwide
- Broad range of AWG sizes, shielding options, and pair counts
- Convenient put-up options
- Polyolefin insulations provide lower capacitance performance when compared to cables

Shielding

Belden meets the demand for highly effective shielding technology with innovative, EMI/RFI-protective foil and braid designs like Beldfoil®. Belden's patented Beldfoil shield is an aluminum/polyester foil construction that yields a lightweight, strong, flexible and thin shield that provides extra insulation and 100% shield coverage. Beldfoil is ideally suited for multiple-pair, individually shielded audio, communication, and data cables.

Product Consistency

By manufacturing our products in ISO-certified, state-of-the-art manufacturing facilities, Belden assures that quality is built into each and every product. Precise diameter control of insulation and jacket diameters and concentric wall thickness assures fast, reliable manufacturing in high-speed automated equipment, and ease of termination and assembly in the field.

Cable Performance Benefits

Belden offers one of the broadest lines of UL Listed, NEC and CEC cables available from any single source. Paired designs allow balanced signal transmission which results in lower crosstalk through common mode rejection. Due to the improved noise immunity of twisted pairs, they generally permit higher data speeds than traditional multiconductor cables.

Find the Right Product for Your Application

Belden Classic products are available from stock from Belden distributors. If the products above do not fit your application, Belden can also engineer specific constructions for your application.

Classic Paired Cables

Paired Computer Cable

AWG	Overall Beldfoil®			Overall Foil/Braid			Individual Foil	Individual Foil + Overall Foil/Braid
	SR-PVC, PVC, [FEP]	PE	Datalene®, [FFEP]	SR-PVC	PE, PP, [FEP]	Datalene, PE, [FFEP]	Datalene, [FFEP]	Datalene
		15.5 pF/Ft (50.9 pF/m)	11.0-13.5 pF/Ft (36.1-44.3 pF/m)		15.5 pF/Ft (50.9 pF/m)	11.0-13.5 pF/Ft (36.1-44.3 pF/m)	11.0-13.5 pF/Ft (36.1-44.3 pF/m)	11.0-13.5 pF/Ft (36.1-44.3 pF/m)
28	—	—	RS-232/485	—	RS-232/422	RS-232/485	—	—
24	RS-232 [RS-232]	RS-232/422	RS-232/422 [RS-232/422]	RS-232	RS-232/423	RS-232/422 RS-485 [RS-485]	RS-422, DA [RS-232/422, DA]	RS-232/422, DA
22	—	—	—	RS-232	POS	—	—	—

DA = Digital Audio • POS = Point of Sale • [Brackets] = High-Temperature Cables.

Audio, Control, and Instrumentation Cables

AWG	Unshielded	Overall Beldfoil®	Individual Foil	Overall Braid
24	ACI	—	ACI	—
22	ACI [ACI]	ACI [ACI]	ACI [ACI]	—
20	ACI	ACI [Special Hi-Temp ACI]	ACI	—
18	ACI [ACI]	ACI [ACI]	ACI	ACI
16	ACI	ACI	—	—
14	ACI	ACI	—	—
12	ACI	ACI	—	—

AIC = Audio, Control, and Instrumentation • DA = Digital Audio • POS = Point of Sale • [Brackets] = High-Temperature Cables.

Classic Paired Cables

Selection Guide

Shielded Multi-Pair Computer Cables RS-232, RS-422, and RS-485 Applications. All Cables are UL Listed.

Specifications	9804	8132	9829	8332	9501	8102	9729	8162	9990	9841	9680	9302^	8302	8777	9873	9773	8132F0	1419A	
Conductor Size: (AWG)	28	✓	✓															✓	
	24			✓	✓	✓	✓	✓	✓	✓	✓								✓
	22											✓	✓	✓					
	20															✓			
	18																✓		
Page No.:	226	226	224	224	219	225	221	229	209	227	220	207	223	211	214	214	220	220	
Insulation:	S-R PVC				✓	✓						✓	✓	✓					
	Polyethylene			✓					✓	✓	✓				✓	✓			
	Polypropylene	✓																	
	Datalene® HDPE		✓				✓	✓	✓								✓	✓	
Shield:	Overall Foil					✓					✓	✓					✓	✓	
	Individual Foil							✓	✓	✓				✓	✓	✓			
	Overall Foil/Braid	✓	✓	✓	✓			✓	✓		✓			✓					
	Braid Coverage	90%	65%	65%	65%		65%		65%		90%			65%					
Drain Wire:	Overall	•	•	•	x	•	•	▲	▲	▲	•	•	•		▲	▲	▲	•	•
	Each Pair							•	•	•					•	•	•		
Pairs Available:	1					✓					✓								
	2	✓	✓	✓	✓	✓	✓	✓	✓		✓	✓						✓	✓
	3	✓	✓	✓	✓	✓	✓	✓	✓	✓	✓		✓	✓	✓	✓	✓	✓	✓
	4	✓	✓	✓	✓	✓	✓	✓	✓		✓	✓	✓					✓	✓
	5	✓	✓	✓	✓	✓	✓		✓				✓					✓	✓
	6			✓	✓	✓	✓	✓	✓	✓		✓	✓	✓	✓	✓	✓		✓
	7	✓		✓	✓	✓	✓		✓				✓						
	8		✓			✓	✓		✓					✓					✓
	9	✓		✓		✓		✓		✓		✓	✓		✓	✓	✓		
	10			✓	✓	✓	✓		✓					✓					
	11							✓							✓	✓			
	12	✓		✓				✓		✓					✓	✓	✓		
	12.5		✓		✓		✓				✓			✓				✓	✓
	13	✓																	
	15				✓	✓	✓	✓	✓				✓	✓	✓	✓	v		✓
	17							✓							✓				
	18	✓	✓	✓	✓		✓		✓					✓					✓
	19					✓		✓					✓	✓					
	25	✓	✓	✓	✓	✓	✓		✓	✓				✓					✓
	27							✓					✓	✓					
31	✓													✓					
37														✓					
50					✓														
Capacitance* (pF/Ft)	15.5	11.0	15.5	30.0	30.0	12.5	12.5	12.5	25.0	12.8	15.5	35.0	35.0	30.0	30.0	30.0	11.0	13.0	
Capacitance* (pF/m)	50.9	36.1	50.9	98.4	98.4	41.0	41.0	41.0	82.0	42.0	50.9	114.8	114.8	98.4	98.4	98.4	36.1	42.7	

^ Standard PVC insulation, solid conductors.

* Capacitance may vary on some cables.

Drain Wire Key: • = Drain wire overall, ▲ = Drain wire each pair, x = No drain wire

HDPE = High-Density Polyethylene • PVC = Polyvinyl Chloride

Overall Beldfoil® Shield
Cable Characteristics

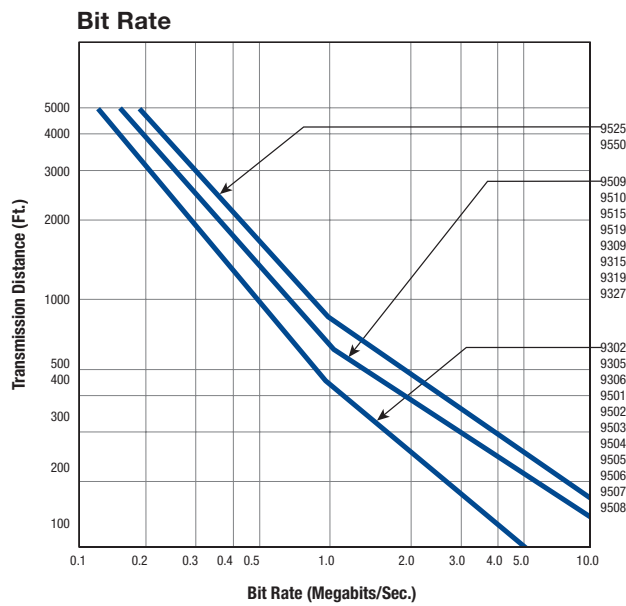
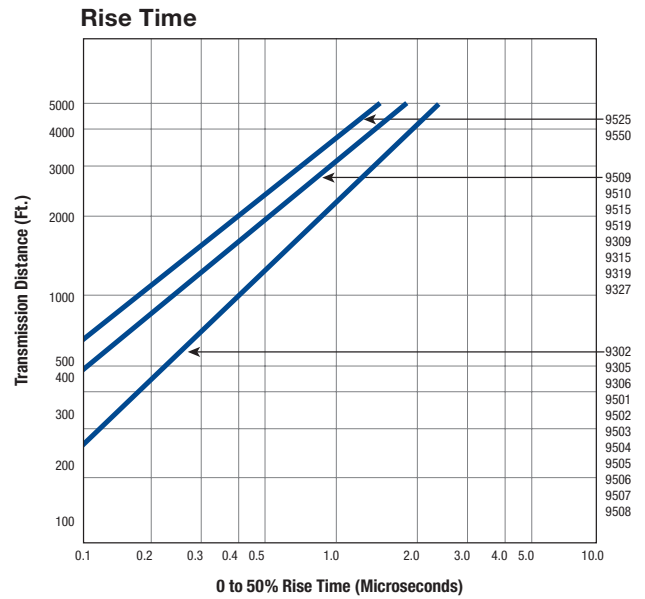
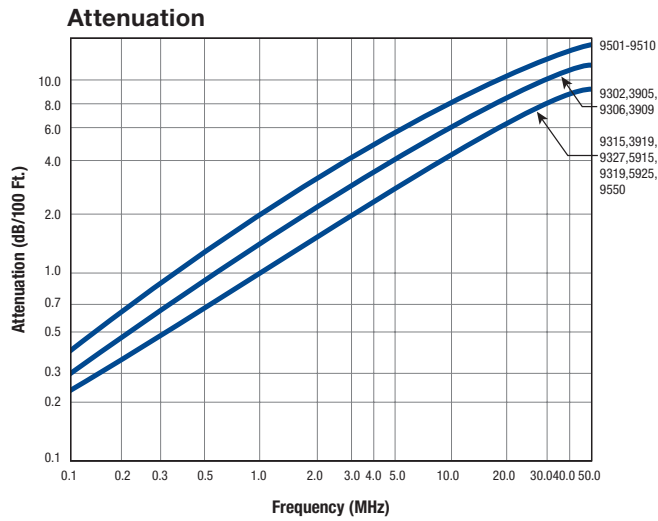

Cables are terminated in their characteristic impedance. Signal source electrical characteristics: 50 ohms and 10% to 90% rise time less than 5 nanoseconds.

Charts assume 5% peak-to-peak time jitter as determined by eye pattern measurements of pseudorandom NRZ code.

Overall Foil/Braid Shield
Cable Characteristics

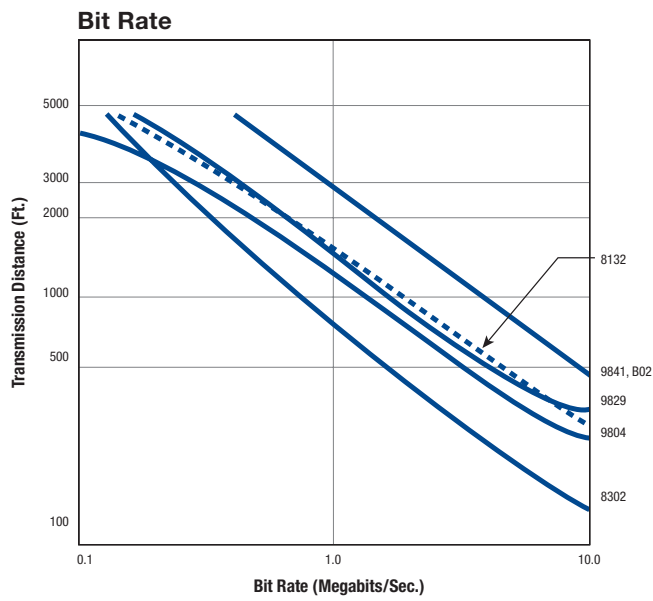
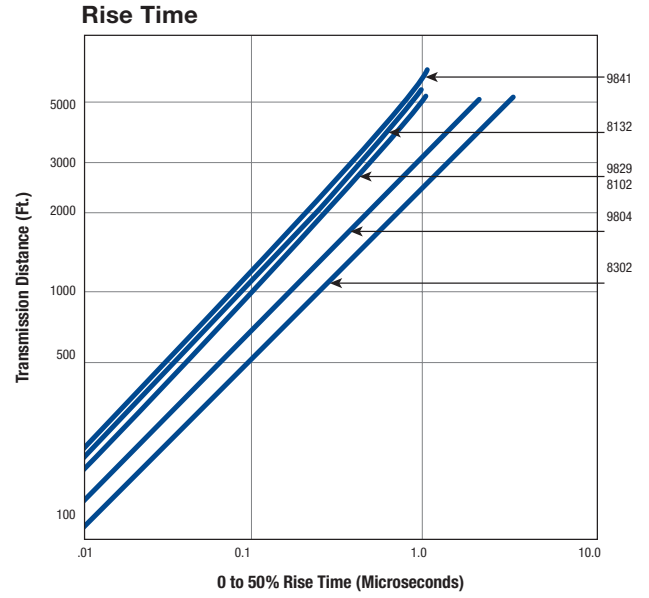
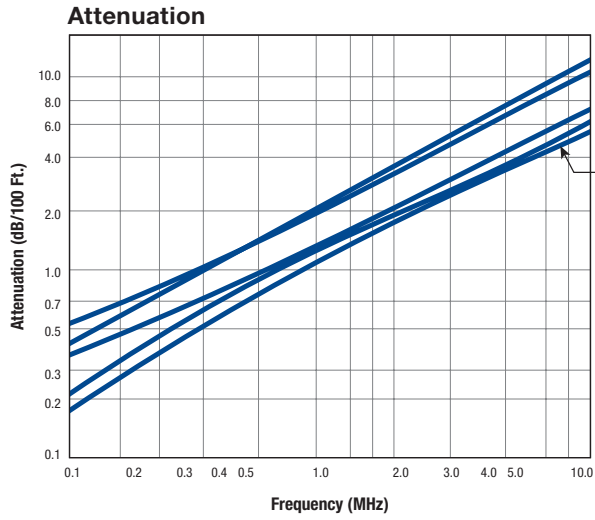

Individually Shielded

Cable Characteristics (Part No. 9728 – 9738)

Attenuation

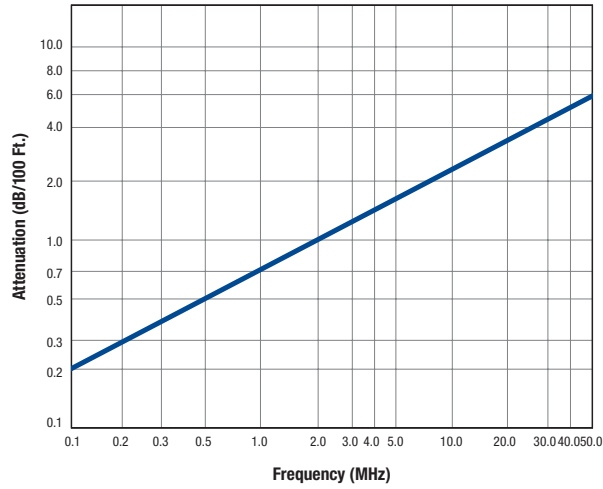

Rise Time

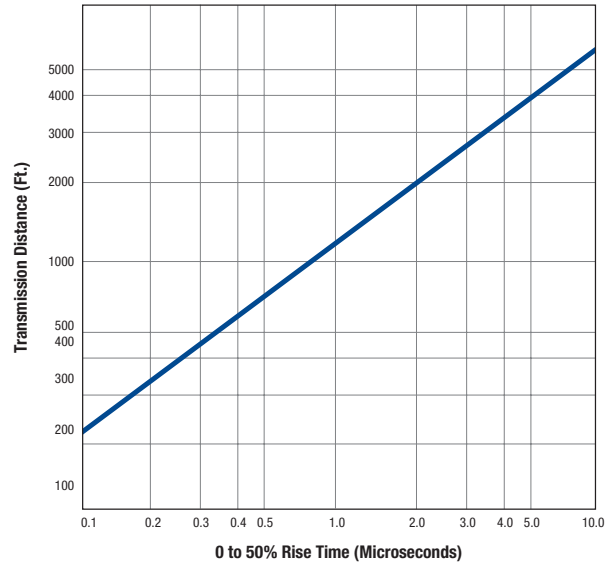

Bit Rate

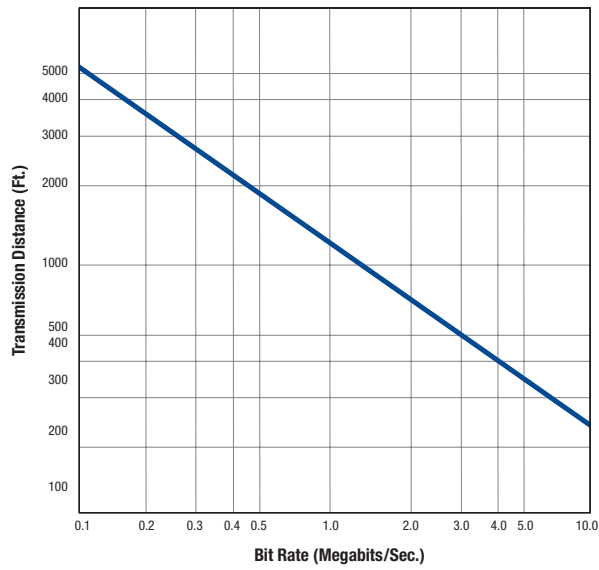

Cables are terminated in their characteristic impedance. Signal source electrical characteristics: 50 ohms and 10% to 90% rise time less than 5 nanoseconds.

Charts assume 5% peak-to-peak time jitter as determined by eye pattern measurements of pseudorandom NRZ code.

Individually Shielded

Cable Characteristics (Part No. 8777 - 9767, 9873 - 9879, 9773 - 9777)

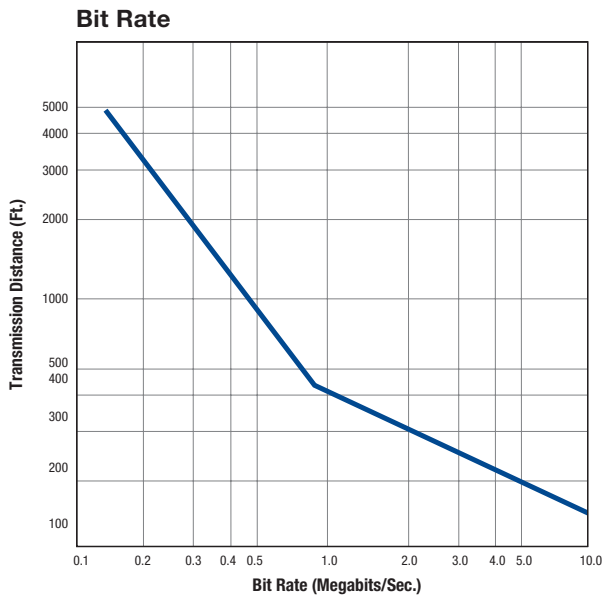
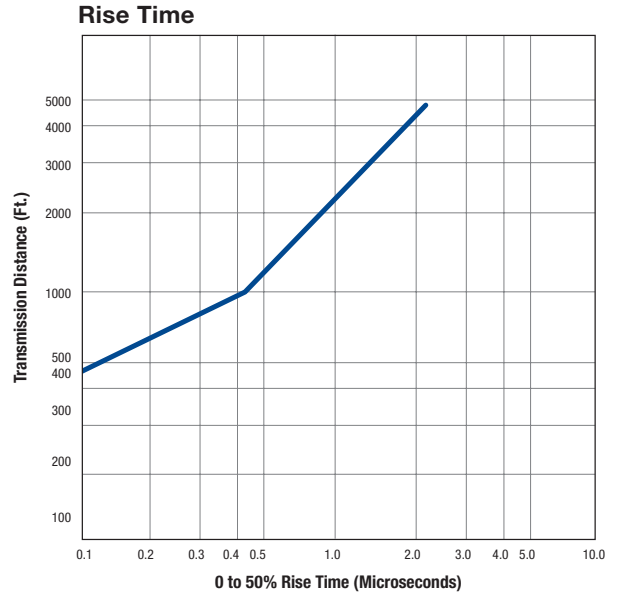
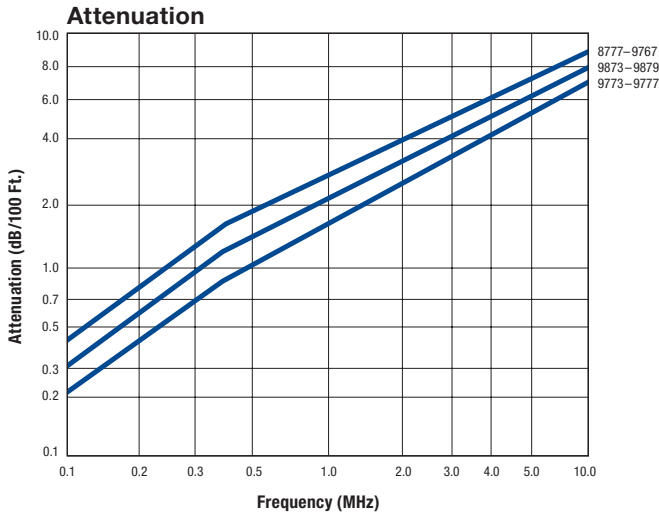

Recommended for audio, pulse, and radio frequency applications requiring superior circuit isolation.

Insulation resistance between shields:
100 megohms/1000' nom.

Capacitance between adjacent shields:
115 pf/ft. nom.

Working voltage between adjacent shields:
50 volts max.

Individually Shielded Pairs with Overall Foil/Braid Shield
Cable Characteristics

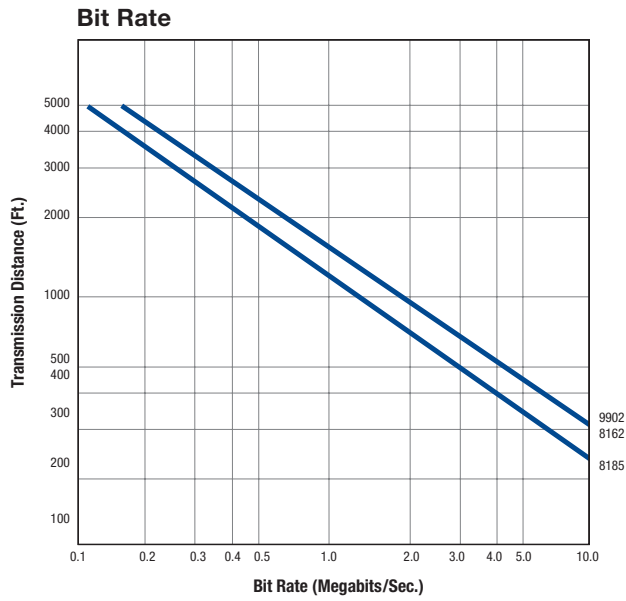
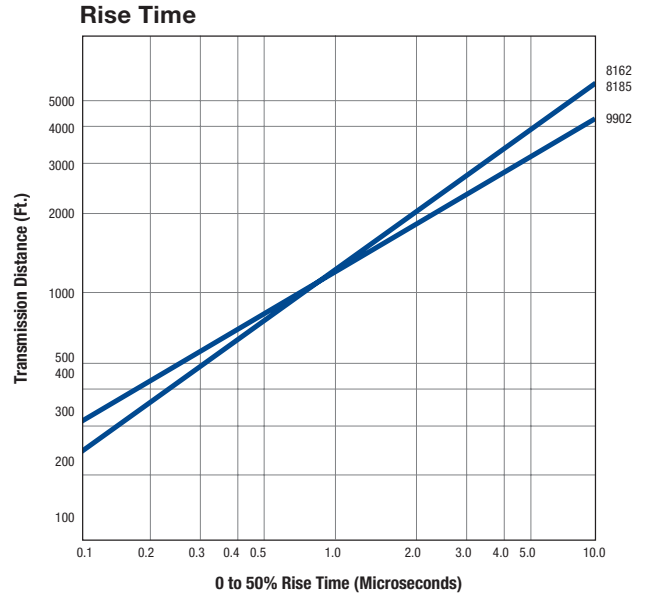
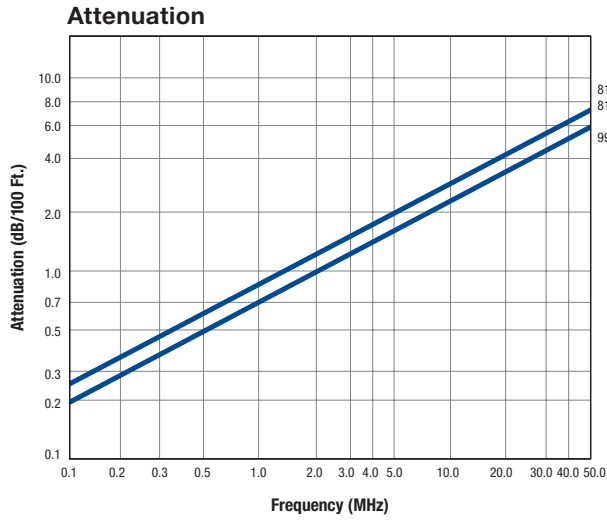

Cables are terminated in their characteristic impedance. Signal source electrical characteristics: 50 ohms and 10% to 90% rise time less than 5 nanoseconds.

Charts assume 5% peak-to-peak time jitter as determined by eye pattern measurements of pseudorandom NRZ code.

Special Audio, Communication and Instrumentation Cables

Combination and Special Shielding



Part No.	Pairs	Color Code	OD (Nom)		Insulation Thickness		Jacket Thickness		Capacitance				Additional Features/Ratings	
			Inch	mm	Inch	mm	Inch	mm	Cond. - Cond.		Cond. - Shield			
										pF/Ft	pF/m	pF/Ft	pF/m	
25 AWG • Polyethylene/PVC														
Stranded (7 x 32) TC Conductors • Polyethylene Insulation • Red-Black Pair Individually Shielded + Overall Beldfoil® Shield • 25 AWG TC Drain Wire • Chrome PVC Jacket. 3 Copper, 4 Copper-Covered Steel Strands in Each Conductor • Pairs Cables on Common Axis to Reduce Diameter.														
8434	2	Black-Red, Green-White	.165	4.19	.013	.33	.020	.51	25	82	49	131	400 V, +80 °C	
22 AWG • PVC/PVC														
Stranded (7 x 30) TC Conductors • PVC Insulation • One Unshielded Single Conductor • One Pair Beldfoil® Shielded • 22 AWG TC Drain Wire • Chrome PVC Jacket														
9685	1.5	Black-White, Brown	.199	5.05	.013	.33	.032	.81	60	197	99	325	NEC: CM Meets NEC Article 800 300 V, +80 °C	
22 AWG • Polypropylene/PVC														
Stranded (7 x 30) TC Conductors • Polypropylene Insulation • One Unshielded Pair • One Beldfoil® Shielded Pair • 24 AWG TC Drain Wire • Chrome PVC Jacket. See Technical Bulletin T/8-21 Before Planning High- And Low-Level Circuits in the Same Cable • Pairs Cables on Common Axis to Reduce Diameter.														
8730	2	Black-Red, Green-White	.205	5.21	.008	.20	.030	.76	34	113	67	220	200 V, +80 °C	
8724	2	Black-Red, Green-White	.185	4.19	.008	.20	.019	.48	34	113	67	220	NEC: CM • CEC: CM 300 V, +80 °C •VW-1	
22 AWG • Polypropylene/PVC														
Stranded (7 x 30) TC Conductors • Polypropylene Insulation • Individually Beldfoil® Shielded Pairs • Polyester Film Over Each Shield • 24 AWG TC Drain Wire for Each Pair • Chrome PVC Jacket. Pairs Cables on Common Axis to Reduce Diameter.														
8728	2	Black-Red, Green-White	.215	5.46	.010	.25	.028	.71	35	115	62	203	NEC: CM • CEC: CM UL AWM Style 2717 (+80 °C)	

TC = Tinned Copper • PVC = Polyvinyl Chloride

Special Audio, Communication and Instrumentation Cables

Combination and Special Shielding



Part No.	Pairs	Color Code	OD (Nom)		Insulation Thickness		Jacket Thickness		Capacitance				Additional Features/Ratings
			Inch	mm	Inch	mm	Inch	mm	Cond. - Cond.		Cond. - Shield		
									pF/Ft	pF/m	pF/Ft	pF/m	

20 AWG • Polyethylene/PVC

Stranded (7 x 28) TC Conductors • Polyethylene Insulation • One Unshielded Single Conductor • One Pair Beldfoil® Shielded • 20 AWG TC Drain Wire • Chrome PVC Jacket													
8763	1.5	Black-Red, Clear	.210	5.33	.014	.36	.028	.71	26	85	48	157	350 V, +80 °C

20 AWG • PVC/PVC

Stranded (7 x 28) TC Conductors • PVC Insulation • One Unshielded Pair • One Beldfoil® Shielded Pair • 22 AWG TC Drain Wire • Chrome PVC Jacket. See Technical Bulletin T/8-21 Before Planning High- And Low-Level Circuits in the Same Cable • Pairs Cables on Common Axis to Reduce Diameter.													
8722	2	Black-Red, Green-White	.226	5.74	.015	.38	.028	.71	60	197	99	325	NEC: CMG • CEC: CMG FT4 350 V, +80 °C VW-1

20 AWG • Polypropylene/PVC

Stranded (7 x 28) TC Conductors • Polypropylene Insulation • Individually Beldfoil® Shielded Pairs Polyester Film Over Each Shield • 22 AWG TC Drain Wire for Each Pair • Chrome PVC Jacket. See Technical Bulletin T/8-21 Before Planning High- And Low-Level Circuits in the Same Cable • Pairs Cables on Common Axis to Reduce Diameter.													
8725	4	Black-Red, Green-White, White/Red-White/Black White/Green-White/Yellow	.345	8.76	.015	.38	.030	.76	27	89	49	161	NEC: CM • CEC: CM 400 V, +105 °C VW-1

20 AWG and 18 AWG • Polyethylene/PVC

Stranded (7 x 28 and 16 x 30) TC Conductors • Polyethylene Insulation • Unshielded 18 AWG Pair • Beldfoil® Shielded 20 AWG Pair • 22 AWG Stranded TC Drain Wire • Beige PVC Jacket													
9155	1 (20 AWG)	Black-Red	.262	6.65	.020	.51	.031	.79	24	79	46	151	NEC: CM • CEC: CM Meets NEC Article 800 UL AWM Style 2094 (300 V, +60 °C)
	1 (18 AWG)	Green-White			.019	.48			22	72			

TC = Tinned Copper • PVC = Polyvinyl Chloride

Audio, Control, and Instrumentation Cables

300 V +80 °C • Unshielded



Part No.	Pairs	Color Code	OD (Nom)		Insulation Thickness		Jacket Thickness		Additional Features/Ratings
			Inch	mm	Inch	mm	Inch	mm	

Stranded TC or Solid BC Conductors • PVC Insulation • Chrome PVC Jacket

20 AWG • 7 x 28 • PVC/PVC

8205	1	Chart 3	.180	4.57	.013	.33	.025	.64	NEC: CMG • CEC: CMG FT4 UL AWM Style 2464 (Except 8205)
9750	3	Chart 3	.299	7.59					
9751	6	Chart 3	.366	9.30	.013	.33	.035	.89	
9752	9	Chart 3	.429	10.90					
9755	15	Chart 3	.545	13.84	.013	.33	.040	1.02	

19 AWG • Solid • PVC/PVC

8486	1	Brown-Tan	.182	4.62	.015	.38	.025	.64	NEC: CM • CEC: CM
------	---	-----------	------	------	------	-----	------	-----	-------------------

18 AWG • 7 x 26 • PVC/PVC

8461	1	Black-White	.234	5.94	.022	.56	.028	.71	NEC: CMG • CEC: CMG FT4
------	---	-------------	------	------	------	-----	------	-----	-------------------------

18 AWG • 16 x 30 • PVC/PVC

9740	1	Chart 3	.210	5.33	.014	.36	.032	.81	NEC: CMG • CEC: CMG FT4 UL AWM Style 2464
9156	2	Chart 3	.333	8.46	.014	.36	.035	.89	
8690	3	Chart 3	.347	8.81					
9157	4	Chart 3	.381	9.68					
9159	5	Chart 3	.391	9.93	.014	.36	.032	.81	
8691	6	Chart 3	.433	11.00					
9161	8	Chart 3	.485	12.32	.014	.36	.037	.94	
8692	9	Chart 3	.524	13.31	.014	.36	.040	1.02	
9741	12	Chart 3	.600	15.24	.014	.36	.046	1.17	
9742	15	Chart 3	.677	17.20	.014	.36	.051	1.30	
9743	19	Chart 3	.721	18.31	.014	.36	.055	1.40	

20 AWG • 7 x 28 • PE/LSZH

Stranded TC Conductors • PE Insulation • Chrome LSZH Jacket

8205NH	1	Chart 3	.180	4.65	.013	.33	.035	.89	Flame IEC 60332-3-24, Smoke IEC 6103
--------	---	---------	------	------	------	-----	------	-----	---

BC = Bare Copper • TC = Tinned Copper • PVC = Polyvinyl Chloride | Belden Color Code Charts can be found at page 344.

Audio, Control, and Instrumentation Cables

Plenum • 300 V, +80 °C • Unshielded



Part No.	Pairs	Color Code	OD (Nom)		Insulation Thickness		Jacket Thickness		Additional Features/Ratings
			Inch	mm	Inch	mm	Inch	mm	

16 AWG • 19 x 29 • PVC/PVC

Stranded TC Conductors • PVC Insulation • Chrome PVC jacket									
8471	1	Black-White	.274	6.96	.023	.58	.032	.81	NEC: CMG • CEC: CMG FT4 UL AWM Style 2598

16 AWG • 19 x 29 • PE/LSZH

Stranded TC Conductors • PE Insulation • LSZH Jacket									
8471NH	1	Black-White	.28	7.10	.023	.58	.035	.89	Flame IEC 60332-3-24, Smoke IEC 6103
8471LS	1	Black-White	.45	11.50	.023	.58	.035/.051	.89/1.30	Flame IEC 60332-3-24, Smoke IEC 6103

14 AWG • 42 x 30 • PVC/PVC

Stranded TC Conductors • PVC Insulation • Chrome PVC jacket									
8473	1	Black-White	.340	8.64	.031	.79	.032	.81	NEC: CL3 • CEC: FAS 90 FT4 UL AWM Style 2587

12 AWG • 65 x 32 • PVC/PVC

Stranded TC Conductors • PVC Insulation • Chrome PVC jacket									
8477	1	Black-White	.386	9.80	.032	.81	.035	.89	NEC: CL3R UL AWM Style 2587

Plenum • 300 V • Unshielded



- NEC: CMP
- CEC: CMP FT6

Part No.	Pairs	Color Code	OD (Nom)		Insulation Thickness		Jacket Thickness	
			Inch	mm	Inch	mm	Inch	mm

22 AWG • FEP/FEP

Stranded (7 x 30) TC Conductors • FEP Insulation • Red FEP Jacket									
88442	1	Chart 3	.102	2.59					
88741	2	Chart 3	.169	4.29	.006	.15	.012	.30	
88757	4	Chart 3	.200	5.08	.006	.15	.019	.23	

22 AWG • FEP/Flamarrest®

Stranded (7 x 30) TC Conductors • FEP Insulation • Natural Flamarrest Jacket									
82442	1	Chart 3	.112	2.84					
82741	2	Chart 3	.179	4.55					
82742	3	Chart 3	.191	4.85	.006	.15	.014	.36	
82757	4	Chart 3	.210	5.33					
82743	6	Chart 3	.238	6.05	.006	.15	.015	.38	

TC = Tinned Copper • FEP = Fluorinated Ethylene Propylene • PVC = Polyvinyl Chloride | Belden Color Code Charts can be found at page 344.

Audio, Control, and Instrumentation Cables

Plenum • 300 V • Unshielded



- NEC: CMP
- CEC: CMP FT6

Part No.	Pairs	Color Code	OD (Nom)		Insulation Thickness		Jacket Thickness	
			Inch	mm	Inch	mm	Inch	mm

18 AWG • FEP/FEP

Stranded (19 x 30) TC Conductors • FEP Insulation • Red FEP Jacket								
89740	1	Black-Red	.136	3.45	.006	.17	.009	.23

18 AWG • FEP/Fluorocopolymer

Plenum • FEP Insulation • Red Fluorocopolymer Jacket								
87740	1	Black-Red	.140	3.56	.006	.17	.011	.28

18 AWG • FEP/Flamarrest®

Plenum • FEP Insulation • Natural Flamarrest Jacket								
82740	1	Black-Red	.147	3.73	.006	.17	.015	.38

150 V, +80 °C • Unshielded



- PVC/PVC
- UL AWM Style 2576
- NEC: CMG
- CEC: CMG FT4

Part No.	Pairs	Color Code	OD (Nom)		Insulation Thickness		Jacket Thickness	
			Inch	mm	Inch	mm	Inch	mm

Solid TC Conductors • PVC Insulation • Chrome PVC Jacket								
--	--	--	--	--	--	--	--	--

24 AWG • PVC/PVC

9562	2	Chart 4	.199	5.05	.010	.25	.032	.81
9566	6	Chart 4	.289	7.34				
9570	10	Chart 4	.310	7.87				
9585	25	Chart 4	.480	12.19				

22 AWG • PVC/PVC

8740	1	Chart 3	.156	3.96	.010	.25	.032	.81
8741	2	Chart 3	.230	5.84				
8742	3	Chart 3	.242	6.15				
8757	4	Chart 3	.264	6.71				
8743	6	Chart 3	.293	7.44				
9160	8	Chart 3	.323	8.20				
8744	9	Chart 3	.350	8.89				

TC = Tinned Copper • FEP = Fluorinated Ethylene Propylene • PVC = Polyvinyl Chloride | Belden Color Code Charts can be found at page 344.

Audio, Control, and Instrumentation Cables

150 V, +80 °C • Unshielded

• UL AWM Style 2576

- NEC: CMG
- CEC: CMG FT4



Part No.	Pairs	Color Code	OD (Nom)		Insulation Thickness		Jacket Thickness	
			Inch	mm	Inch	mm	Inch	mm

22 AWG • PVC/PVC

Stranded (7 x 30) TC Conductors • PVC Insulation • Chrome PVC Jacket								
9744	2	Chart 3	.244	6.20				
9745	3	Chart 3	.257	6.53	.010	.25	.032	.81
9746	4	Chart 3	.281	7.14				
8747	6	Chart 3	.320	8.13	.010	.25	.035	.89
8748	9	Chart 3	.389	9.88	.010	.25	.037	.94
9747	12	Chart 3	.425	10.80				
8749	15	Chart 3	.440	11.18	.010	.25	.040	1.02
9748	19	Chart 3	.505	12.83				
8750	27	Chart 3	.575	14.61	.010	.25	.045	1.14

TC = Tinned Copper • PVC = Polyvinyl Chloride | Belden Color Code Charts can be found at page 344.

Audio, Control, and Instrumentation Cables

Overall Beldfoil® Shield



Part No.	Pairs	Color Code	OD (Nom)		Insulation Thickness		Jacket Thickness		Capacitance				Additional Features/Ratings
			Inch	mm	Inch	mm	Inch	mm	Cond. - Cond.		Cond. - Shield		
									pF/Ft	pF/m	pF/Ft	pF/m	
22 AWG • Polypropylene/PVC													
Solid TC Conductors • Polypropylene Insulation • Overall Beldfoil® Shield • 22 AWG Solid TC Drain Wire • Gray or Black PVC Insulation													
8450	1	Black-Red	.118	3.00	.007	.18	.018	.46	40	133	76	249	NEC: CM • CEC: CM 300 V, +75 °C
22 AWG • Polypropylene/PVC													
Solid TC Conductors • Polypropylene Insulation • Overall Beldfoil® Shield • 22 AWG Stranded TC Drain Wire • Chrome PVC Insulation													
8752	38	Tech Bulletin T/8-4	.610	15.50	.008	.20	.045	1.14	17	56	24.3	80	200 V, +75 °C
22 AWG • SR-PVC/PVC													
Stranded (7 x 30) TC Conductors • Semi-Rigid PVC Insulation • Overall Beldfoil® Shield • 22 AWG Stranded TC Drain Wire • Pale Fawn Beige Striated PVC Jacket													
9414	1	White-Black	.186	4.72	.010	.25	.035	.89	50	164	95	312	NEC: CMG • CEC: CMG FT4 UL AWM Style 2464 (300 V, +80 °C)
22 AWG • PVC/PVC													
Stranded (7 x 30) TC Conductors • PVC Insulation • Overall Beldfoil® Shield • 22 AWG Stranded TC Drain Wire • Chrome PVC Jacket													
9462	1	Black-Red	.186	4.72	.013	.33	.035	.89	50	164	90	295	200 V, +75 °C
22 AWG • Polyethylene/PVC													
Stranded (7 x 30) TC Conductors • Polyethylene Insulation • Overall Beldfoil® Shield • 22 AWG Stranded TC Drain Wire • Chrome PVC Jacket													
8761	1	Black-Clear	.175	4.45	.016	.41	.025	.64	24	79	47	154	NEC: CM • CEC: CM UL AWM Style 2092 (300 V, +60 °C)
22 AWG • Polyethylene/LSZH													
Stranded (7x30) TC Conductors • Polyethylene Insulation • Overall Beldfoil® Shielding • 22 AWG Stranded TC Drain Wire • Chrome LSZH Jacket													
8761NH	1	Black-Clear	.19	4.95	.016	.41	.035	.89	24	79	47	154	Flame IEC 60332-3-24, Smoke IEC 6103
22 AWG • Polyethylene/PVC													
Stranded (7 x 30) TC Conductors • Polyethylene Insulation • Overall Beldfoil® Shield • 22 AWG Stranded TC Drain Wire • Chrome PVC Jacket Jacket and Shield Are Bonded So Both Can Be Removed on Automatic Stripping Equipment. Drain Wire Is Inside Foil Shield.													
9461	1	Black-Clear	.180	4.57	.016	.41	.026	.66	24	79	47	154	NEC: CM • CEC: CM UL AWM Style 2092 (300 V, +60 °C)
22 AWG • Polypropylene/PVC													
Stranded (7 x 30) TC Conductors • Polypropylene Insulation • Overall Beldfoil® Shield • 22 AWG Stranded TC Drain Wire • Paper Wrap (to Facilitate Stripping) • Gray or Black PVC Jacket Jacket and Shield Are Bonded So Both Can Be Removed on Automatic Stripping Equipment. Drain Wire Is Inside Foil Shield.													
8451	1	Black-Red	.138	3.51	.008	.20	.020	.51	34	112	67	220	NEC: CMR • CEC: CMG 300 V, 75°V

TC = Tinned Copper • LSZH = Low Smoke Zero Halogen • PVC = Polyvinyl Chloride

Audio, Control, and Instrumentation Cables

Overall Beldfoil® Shield



Part No.	Pairs	Color Code	OD (Nom)		Insulation Thickness		Jacket Thickness		Capacitance				Additional Features/Ratings
			Inch	mm	Inch	mm	Inch	mm	Cond. - Cond.		Cond. - Shield		
									pF/Ft	pF/m	pF/Ft	pF/m	

22 AWG • Polypropylene/PVC

Stranded (7 x 30) TC Conductors • Polypropylene Insulation • Overall Beldfoil® Shield • 22 AWG Stranded TC Drain Wire • PVC Jacket (Black, Gray, Brown, Red, Orange, Yellow, Green, Blue, Purple, White)													
9451	1	Black-Red	.135	3.43	.008	.20	.020	.51	35	115	67	220	NEC: CMR • CEC: CMG FT4 300 V, +75 °C

22 AWG • Polypropylene/LSZH

Stranded (7 x 30) TC Conductors • Polypropylene Insulation • Overall Beldfoil® Shield • 22 AWG Stranded TC Drain Wire • Black LSZH Jacket Jacket and Shield Are Bonded So Both Can Be Removed on Automatic Stripping Equipment. Drain Wire Is Inside Foil Shield.													
9451SB	1	Black-Red	.160	4.06	.008	.20	.032	.81	35	115	67	220	NEC: CMG-LS • CEC: CMG-LS FT4 300 V, +105 °C

22 AWG • Polyolefin/PVC

Stranded (7 x 30) TC Conductors • Polyolefin Insulation • Overall Beldfoil® Shield • 22 AWG Stranded TC Drain Wire • PVC Jacket (Red-Green, Red-Black, Red-Purple, Red-Gray)													
9451D	2	Black-Red	.135 x .270	3.43 x 6.86	.008	.20	.020	.51	34	112	67	220	Zipcord Construction NEC: CMR • CEC: CMR FT4 300 V, +60 °C

22 AWG • Polypropylene/PVC

Unique Design Features Lower Capacitance and Greater Flexibility Than Standard Audio Pair Constructions.

Stranded (7 x 30) TC Conductors • Polypropylene Insulation • Overall Beldfoil® Shield • 24 AWG Stranded TC Drain Wire • PVC Jacket (Black, Gray, Brown, Red, Orange, Yellow, Green, Blue, Purple, White)													
1266A	1	Black-Red	.143	3.63	.010	.25	.020	.51	30	99	54	177	NEC: CM • CEC: CM 300 V

22 AWG • PVC/PVC

Unique Design Features Lower Capacitance and Greater Flexibility Than Standard Audio Pair Constructions.

Stranded (7 x 30) TC Conductors • PVC Insulation • Overall Beldfoil® Shield • 24 AWG Stranded TC Drain Wire • PVC Jacket (Black, Gray, Brown, Red, Orange, Yellow, Green, Blue, Purple, White)													
1503A	1	Black-Red	.142	3.61	.010	.25	.020	.51	53	174	97	318	NEC: CM • CEC: CM 300 V

22 AWG • PVC/PVC

Stranded (19 x 34) TC Conductors • PVC Insulation • Overall Beldfoil® Shield • 24 AWG Stranded TC Drain Wire • PVC Jacket (Red-Green, Red-Purple, Red-Gray)													
1504A	2	Black-Red	.143 x .286	3.63 x 7.26	.010	.25	.017	.43	57	187	100	328	Stereo Audio Cable Zipcord Construction NEC: CM • CEC: CM 150 V

TC = Tinned Copper • LSZH = Low Smoke Zero Halogen • PVC = Polyvinyl Chloride

Audio, Control, and Instrumentation Cables

Overall Beldfoil® Shield



Part No.	Pairs	Color Code	OD (Nom)		Insulation Thickness		Jacket Thickness		Capacitance				Additional Features/Ratings
			Inch	mm	Inch	mm	Inch	mm	Cond. - Cond.		Cond. - Shield		
									pF/Ft	pF/m	pF/Ft	pF/m	
22 AWG • FEP/Flamarrest®													
Stranded (19 x 34) TC Conductors • FEP Insulation • Overall Beldfoil® Shield • 22 AWG Stranded TC Drain Wire • White Flamarrest Jacket Jacket and Shield Are Bonded So Both Can Be Removed on Automatic Stripping Equipment. Drain Wire Is Inside Foil Shield.													
9451DP	2	Black-Red, Black-White	.127 x .269	3.43 x 6.86	.007	.18	.017	.43	35	115	67	220	Plenum Zipcord Construction NEC: CMP • CEC: CMP FT6 300 V
22 AWG • FEP/Flamarrest®													
Stranded (7 x 30) TC Conductors • FEP Insulation • Overall Beldfoil® Shield • 22 AWG Stranded TC Drain Wire • Flamarrest Jacket (Black, Gray, Brown, Red, Orange, Yellow, Green, Blue, Purple, White)													
9451P	1	Black-Red	.127	3.23	.007	.18	.017	.43	35	115	67	220	NEC: CMP • CEC: CMP FT6
22 AWG • FEP/Flamarrest®													
Stranded (7 x 30) TC Conductors • FEP Insulation • Overall Beldfoil® Shield • 22 AWG Stranded TC Drain Wire • Natural Flamarrest Jacket													
82761	1	Black-Red	.116	2.95	.006	.15	.014	.36	35	115	67	220	NEC: CMP • CEC: CMP FT6
22 AWG • FEP/FEP													
Stranded (7 x 30) TC Conductors • FEP Insulation • Overall Beldfoil® Shield • 22 AWG Stranded TC Drain Wire • Red FEP Jacket													
88761	1	Black-Red	.119	3.02	.006	.15	.014	.36	35	115	67	220	NEC: CMP • CEC: CMP FT6
22 AWG • FEP/Fluorocopolymer													
Stranded (7 x 30) TC Conductors • FEP Insulation • Overall Beldfoil® Shield • 22 AWG Stranded TC Drain Wire • Red Fluorocopolymer Jacket													
87761	1	Black-Red	.116	2.95	.006	.15	.014	.36	35	115	67	220	NEC: CMP • CEC: CMP FT6

TC = Tinned Copper • FEP = Fluorinated Ethylene Propylene

Audio, Control, and Instrumentation Cables

Overall Beldfoil® Shield



Part No.	Pairs	Color Code	OD (Nom)		Insulation Thickness		Jacket Thickness		Capacitance				Additional Features/Ratings
			Inch	mm	Inch	mm	Inch	mm	Cond. - Cond.		Cond. - Shield		
									pF/Ft	pF/m	pF/Ft	pF/m	

20 AWG • PVC/PVC

Stranded (7 x 28) TC Conductors • PVC Insulation • Overall Beldfoil® Shield • 22 AWG Stranded TC Drain Wire • Beige PVC Jacket														
9154	1	Black, Red	.198	5.03	.014	.36	.031	.79						NEC: CMG • CEC: CMG FT4 UL AWM Style 2464 (300 V, +80 °C)

20 AWG • Polyethylene/PVC

Stranded (7 x 28) TC Conductors • Polyethylene Insulation • Overall Beldfoil® Shield • 20 AWG Stranded TC Drain Wire • Chrome PVC Jacket														
8762	1	Black-Clear	.204	5.18	.016	.41	.028	.71	27	89	49	161		NEC: CM • CEC: CM UL AWM Style 2092 (300 V, +60 °C)

20 AWG • Polyethylene/LSZH

Stranded (7 x 28) TC Conductors • Polyethylene Insulation • Overall Beldfoil® Shielding • 20 AWG Stranded TC Drain • Wire Chrome LSZH Jacket														
8762NH	1	Black-Clear	.21	5.40	.016	.41	.035	.89	27	89	49	161		Flame IEC 60332-3-24, Smoke IEC 6103

18 AWG • Polyethylene/PVC

Stranded (19 x 30) TC Conductors • Polyethylene Insulation • Overall Beldfoil® Shield • 20 AWG TC Drain Wire Chrome PVC Jacket														
8760	1	Black-Clear	.222	5.64	.019	.48	.028	.71	24	79	44	144		NEC: CM • CEC: CM UL AWM Style 2092 (300 V, +60 °C)

18 AWG • Polyethylene/LSZH

Stranded (19 x 30) TC Conductors • Polyethylene Insulation • Overall Beldfoil® Shield • 20 AWG Stranded TC Drain Wire • Chrome LSZH Jacket														
8760NH	1	Black-Clear	.24	6.00	.016	.41	.035	.89	30	98	44	144		Flame IEC 60332-3-24, Smoke IEC 6103
8760LS	1	Black-Clear	.41	10.40	.016	.41	.035/ .051	.89/ 1.30	30	98	44	144		Flame IEC 60332-3-24, Smoke IEC 6103 Steel Wire Armor

18 AWG • Polyethylene/PVC

Stranded (19 x 30) TC Conductors • Polyethylene Insulation • Overall Beldfoil® Shield • 20 AWG TC Drain Wire • Chrome PVC Jacket Jacket and Shield Are Bonded So Both Can Be Removed on Automatic Stripping Equipment. Drain Wire Is Inside Foil Shield.														
9460	1	Black-Clear	.230	5.84	.019	.48	.030	.76	24	79	44	144		NEC: CM • CEC: CM UL AWM Style 2092 (300 V, +60 °C)

18 AWG • FEP/FEP

Stranded (19 x 30) TC Conductors • FEP Insulation • Overall Beldfoil® Shield • 20 AWG TC Drain Wire • Red FEP Jacket														
88760	1	Black-Red	.150	3.81	.007	.18	.014	.36	51	167	97	318		NEC: CMP • CEC: CMP FT6 300 V

18 AWG • FEP/Fluorocopolymer

Stranded (19 x 30) TC Conductors • FEP Insulation • Overall Beldfoil® Shield • 20 AWG TC Drain Wire • Red Fluorocopolymer Jacket														
87760	1	Black-Red	.150	3.81	.007	.18	.014	.36	51	167	97	318		NEC: CMP • CEC: CMP FT6 300 V

18 AWG • FEP/Flamarrest®

Stranded (19 x 30) TC Conductors • FEP Insulation • Overall Beldfoil® Shield • 20 AWG TC Drain Wire • Natural Flamarrest Jacket														
82760	1	Black-Red	.150	3.81	.007	.18	.014	.36	51	167	97	318		NEC: CMP • CEC: CMP FT6 300 V

TC = Tinned Copper • FEP = Fluorinated Ethylene Propylene • PVC = Polyvinyl Chloride

Audio, Control, and Instrumentation Cables

Overall Beldfoil® Shield



Part No.	Pairs	Color Code	OD (Nom)		Insulation Thickness		Jacket Thickness		Capacitance				Additional Features/Ratings
			Inch	mm	Inch	mm	Inch	mm	Cond. - Cond.		Cond. - Shield		
									pF/Ft	pF/m	pF/Ft	pF/m	
16 AWG • 19 x 29 • Polyethylene/PVC													
Stranded TC Conductors • Polyethylene Insulation • Overall Beldfoil® Shield • 18 AWG Stranded TC Drain Wire • Chrome PVC Jacket													
8719	1	Black-Clear	.313	7.95	.032	.81	.032	.81	23	75	44	144	NEC: CM, CL2 • CEC: CM UL AWM Style 20253 (600 V, +80 °C)
16 AWG • 19 x 29 • Polyethylene/LSZH													
Stranded TC Conductors • Polyethylene Insulation • Overall Beldfoil® Shield • 18 AWG Stranded TC Drain Wire • Chrome LSZH Jacket													
8719NH	1	Black-Clear	.32	8.10	.032	.81	.030	.75	23	75	44	144	Flame IEC 60332-3-24, Smoke IEC 6103
14 AWG • 19 x 27 • Polyethylene/PVC													
Stranded TC Conductors • Polyethylene Insulation • Overall Beldfoil® Shield • 18 AWG Stranded TC Drain Wire • Chrome PVC Jacket													
8720	1	Black-Clear	.355	9.02	.032	.81	.035	.89	24	79	47	154	NEC: CM, CL2 UL AWM Style 20253 (600 V, +80 °C)
12 AWG • 19 x 25 • Polyethylene/PVC													
Stranded TC Conductors • Polyethylene Insulation • Overall Beldfoil® Shield • 18 AWG Stranded TC Drain Wire • Chrome PVC Jacket													
8718	1	Black-Clear	.400	10.16	.037	.94	.040	1.02	25	82	49	161	NEC: CL2 C(UL) AWM II A UL AWM Style 20253 (600 V, +80 °C)

TC = Tinned Copper • PVC = Polyvinyl Chloride

Audio, Control, and Instrumentation Cables

300 V, +60 °C • Overall Beldfoil® Shield

- NEC: CMG
- CEC: CMG FT4



Part No.	Pairs	Color Code	OD (Nom)		Insulation Thickness		Jacket Thickness		Capacitance				Additional Features/Ratings
			Inch	mm	Inch	mm	Inch	mm	Cond. - Cond.		Cond. - Shield		
									pF/Ft	pF/m	pF/Ft	pF/m	

22 AWG • PVC/PVC

Solid TC Conductors • PVC Insulation • Overall Beldfoil® Shield • 22 AWG Stranded TC Drain Wire • Chrome PVC Jacket														
9302	2	Chart 3	.244	6.20										
9305	4	Chart 3	.265	6.73	.013	.33	.032	.81						
9306	6	Chart 3	.315	8.00										
9309	9	Chart 3	.363	9.22	.013	.33	.033	.84	35	115	50	164	AWM Style 2464 (300 V, +80 °C)	
9315	15	Chart 3	.449	11.41	.013	.33	.037	.94						
9319	19	Chart 3	.495	12.57	.013	.33	.040	1.02						
9327	27	Chart 3	.615	15.62	.013	.33	.045	1.14						
8751	51	Note 1	.710	18.03	.013	.33	.050	1.27	30	98	42.8	140	300 V, +60 °C	

Note 1: See Tech Bulletin T/8-4.

300 V • Overall Duofoil® Shield

- NEC: CM
- CEC: CM



Part No.	Pairs	Color Code	OD (Nom)		Insulation Thickness		Jacket Thickness		Capacitance				Additional Features/Ratings
			Inch	mm	Inch	mm	Inch	mm	Cond. - Cond.		Cond. - Shield		
									pF/Ft	pF/m	pF/Ft	pF/m	

22 AWG • Datalene®/PVC

Solid TC Conductors • Datalene Insulation • Overall Duofoil Shielding • 22 AWG Stranded TC Drain Wire • Black PVC Jacket													
9184	2	Black-Yellow, Red-Blue	.385	9.78	.035	.89	.041	1.03	8.7	25.5	14.1	46.3	150 Ω Nom. Impedance 78% Velocity of Prop. Conductor DCR (Nom): 16.5/1000' (54.13 Ω/km)

TC = Tinned Copper • PVC = Polyvinyl Chloride | Belden Color Code Charts can be found at page 344.

Audio, Control, and Instrumentation Cables

300 V, +80 °C • Overall Beldfoil® Shield • Plenum and Non-Plenum



Part No.	Pairs	Color Code	OD (Nom)		Insulation Thickness		Jacket Thickness		Capacitance				Additional Features/Ratings
			Inch	mm	Inch	mm	Inch	mm	Cond. - Cond.		Cond. - Shield		
									pF/Ft	pF/m	pF/Ft	pF/m	

24 AWG • Polyolefin/PVC

Stranded (7 x 32) TC Conductors • Polyolefin Insulation • Overall Beldfoil® Shield • 24 AWG TC Drain Wire • Matte Black PVC Jacket													
1508A	1	Black-Red	.131	3.33	.008	.20	.024	.61	31	102	58	190	NEC: CM

24 AWG • Polypropylene/PVC

Stranded (7 x 32) TC Conductors • Polypropylene Insulation • Overall Beldfoil® Shield • 24 AWG TC Drain Wire • PVC Jacket (Gray, Brown, Red, Green, Light Blue, Purple, White, or Black). Jacket and Shield Are Bonded So Both Can Be Removed With Automatic Stripping Equipment. For Cross-Connect Use With 1408R Snake Cables.													
1883A	1	Black-Red	.123	3.12	.008	.29	.020	.51	31	102	58	190	NEC: CMR • CEC: CMR FT4

24 AWG • Polyethylene/PVC

Stranded (7 x 32) TC Conductors • Polyethylene Insulation • Overall Beldfoil® Shield • 24 AWG TC Drain Wire • Chrome PVC Jacket													
8641	1	Black-Clear	.168	4.27	.016	.41	.025	.64	22	72	42	138	NEC: CM • CEC: CM AWM Style 2092

24 AWG • FEP/FEP

Stranded (7 x 32) TC Conductors • FEP Insulation • Overall Beldfoil® Shield • 24 AWG TC Drain Wire • Red FEP Jacket													
88641	1	Black-Red	.106	2.69	.006	.15	.014	.36	31	102	59	194	Plenum • Non-Conduit NEC: CMP • CEC: CMP FT6

24 AWG • FEP/Flamarrest®

Stranded (7 x 32) TC Conductors • FEP Insulation • Overall Beldfoil® Shield • 24 AWG TC Drain Wire • Red Flamarrest Jacket													
82641	1	Black-Red	.106	2.69	.006	.15	.014	.36	31	102	59	194	Plenum • Non-Conduit NEC: CMP • CEC: CMP FT6

High-Temperature • 300 V, +150 °C • Overall Beldfoil® Shield



Part No.	Pairs	Color Code	OD (Nom)		Insulation Thickness		Jacket Thickness		Capacitance				Additional Features/Ratings
			Inch	mm	Inch	mm	Inch	mm	Cond. - Cond.		Cond. - Shield		
									pF/Ft	pF/m	pF/Ft	pF/m	

20 AWG • ETFE/ETFE

Stranded (7 x 28) TC Conductors • ETFE Insulation Overall Beldfoil® Shield • 22 AWG TC Drain Wire • Clear ETFE Jacket													
85164	4	Chart 3	.344	8.74	.015	.38	.025	.64	23	75	40	111	VW-1
85168	8	Chart 3	.439	11.15									

TC = Tinned Copper • ETFE = Ethylene/TFE = Tetrafluoroethylene • FEP = Fluorinated Ethylene Propylene • PVC = Polyvinyl Chloride | Belden Color Code Charts can be found at page 344.

Audio, Control, and Instrumentation Cables

Individually Shielded Pairs

- NEC: CM
- CEC: CM



Part No.	Pairs	Color Code	OD (Nom)		Insulation Thickness		Jacket Thickness		Capacitance				Additional Features/Ratings
			Inch	mm	Inch	mm	Inch	mm	Cond. - Cond.		Cond. - Shield		
									pF/Ft	pF/m	pF/Ft	pF/m	

24 AWG • Polyethylene/PVC

Stranded (7 x 32) TC Conductors • Polyethylene Insulation • Individually Beldfoil® Shielded Pairs • 24 AWG TC Drain Wire • Chrome PVC Jacket														
9990	3	Chart 3	.255	6.48										UL AWM Style 2919 (30 V, +80 °C) 60 Ω Nom. Impedance 66% Velocity of Prop. Conductor DCR (Nom): 24.0 Ω/1000' (78.7 Ω/km)
9991	6	Chart 3	.330	8.38										
9992	9	Chart 3	.383	9.73	.011	.28	.035	.89						
9993	12	Chart 3	.428	10.87					25	82	47	154		
9995	25	Chart 3	.636	16.15	.011	.28	.052	1.32						

Individually Shielded Pairs

- NEC: MPG, CMG
- CEC: MPG, CMG FT4



Part No.	Pairs	Color Code	OD (Nom)		Insulation Thickness		Jacket Thickness		Capacitance				Additional Features/Ratings
			Inch	mm	Inch	mm	Inch	mm	Cond. - Cond.		Cond. - Shield		
									pF/Ft	pF/m	pF/Ft	pF/m	

22 AWG • Polyethylene/PVC

Solid TC Conductors • Polyethylene Insulation • Individually Beldfoil® Shielded Pairs • 22 AWG TC Drain Wire • Chrome PVC Jacket														
8767	3	Chart 3	.279	7.10	.013	.33	.037	.94						UL AWM Style 2464 (300 V, +80 °C)
8768	6	Chart 3	.379	9.60	.013	.33	.037	.94						
8764	9	Chart 3	.425	10.80	.013	.33	.040	1.02	40	131	77	253		
8766	15	Chart 3	.525	13.30	.013	.33	.045	1.14						

TC = Tinned Copper • ETFE = Ethylene/TFE = Tetrafluoroethylene • FEP = Fluorinated Ethylene Propylene • PVC = Polyvinyl Chloride | Belden Color Code Charts can be found at page 344.

Audio, Control, and Instrumentation Cables

Individually Shielded Pairs • RS-485



Part No.	Pairs	Color Code	OD (Nom)		Insulation Thickness		Jacket Thickness		Capacitance				Additional Features/Ratings
			Inch	mm	Inch	mm	Inch	mm	Cond. - Cond.		Cond. - Shield		
									pF/Ft	pF/m	pF/Ft	pF/m	

22 AWG • SR-PVC/PVC

Stranded (7 x 30) TC Conductors • PVC Insulation • Individually Beldfoil® Shielded Pairs • 22 AWG TC Drain Wire • Pale Fawn Beige PVC Jacket • Pairs Parallel Under Jacket													
9406	2	Black-White Black-Yellow	.173 x .280	4.39 x 7.11	.011	.28	.033	.84	50	164	95.5	312	NEC: CMG • CEC: CMG FT4 UL AWM Style 2464 (300 V, +80 °C) 50 Ω Nom. Impedance 60% Velocity of Prop. Conductor DCR (Nom): 15.0 Ω/1000' (49.2 Ω/km)

22 AWG • Polypropylene/PVC

Stranded (7 x 30) TC Conductors • Polypropylene Insulation • Individually Beldfoil® Shielded Pairs • 22 AWG TC Drain Wire • Chrome PVC Jacket • Pairs Cabled on a Common Axis to Reduce Diameter													
8723	2	Black-Red Green-White	.160	4.06	.009	.22	.020	.51	35	115	62	203	NEC: CM • CEC: CM 300 V, +60 °C 45 Ω Nom. Impedance 66% Velocity of Prop. Conductor DCR (Nom): 14.7 Ω/1000' (48.2 Ω/km)

22 AWG • Polypropylene/LSZH

Stranded (7 x 30) TC Conductors • Polypropylene Insulation • Individually Beldfoil® Shielded Pairs • 22 AWG TC Drain Wire • Black LSZH Jacket • Pairs Cabled on a Common Axis to Reduce Diameter													
8723SB	2	Black-Red Green-White	.196	4.98	.009	.22	.034	.86	35	115	62	203	NEC: CMG-LS • CEC: CMG-LS FT4 Limited Smoke 300 V, +60 °C 45 Ω Nom. Impedance 66% Velocity of Prop. Conductor DCR (Nom): 14.7 Ω/1000' (48.2 Ω/km)

22 AWG • Polypropylene/LSZH

Stranded (7 x 30) TC Conductors • Polypropylene Insulation • Individually Beldfoil® Shielded Pairs • 22 AWG TC Drain Wire • Chrome LSZH Jacket • Pairs Cabled on Common Axis to Reduce Diameter													
8723NH	2	Black-Red Green-White	.180	4.55	.009	.22	.026	.65	17	55	35	115	Flame IEC 60332-3-24, Smoke IEC 6103, 45 Ω Nim. Impedance, 65% Velocity of Prop., Conductor DCR (Nom): 14.7 Ω/100' (48.2 Ω/km)
8723LS	2	Black-Red Green-White	.350	8.80	.009	.22	.026/ .049	.65/ 1.25	17	55	35	115	Flame IEC 60332-3-24, Smoke IEC 6103, 45 Ω Nim. Impedance, 65% Velocity of Prop., Conductor DCR (Nom): 14.7 Ω/100' (48.2 Ω/km) Steel Wire Armor

TC = Tinned Copper • LSZH = Low Smoke Zero Halogen • PVC = Polyvinyl Chloride

Audio, Control, and Instrumentation Cables

Individually Shielded Pairs • RS-485



Part No.	Pairs	Color Code	OD (Nom)		Insulation Thickness		Jacket Thickness		Capacitance				Additional Features/Ratings
			Inch	mm	Inch	mm	Inch	mm	Cond. - Cond.		Cond. - Shield		
									pF/Ft	pF/m	pF/Ft	pF/m	

22 AWG • Polypropylene/PVC

Stranded (7 x 30) TC Conductors • Polypropylene Insulation • Individually Beldfoil® Shielded Pairs • 22 AWG TC Drain Wire • Chrome PVC Jacket														
8777	3	Chart 3	.273	6.93										
8778	6	Chart 3	.362	9.19	.011	.28	.034	.86						
8774	9	Chart 3	.417	10.59										
8775	11	Chart 3	.464	11.79										
9768	12	Chart 3	.464	11.79	.011	.28	.036	.91						
8776	15	Chart 3	.548	13.92					30	98	55	180		
9769	17	Chart 3	.577	14.66	.011	.28	.052	1.32						
8769	19	Chart 3	.603	15.32										
8773	27	Chart 3	.709	18.00	.011	.28	.064	1.63						
9767	37	Chart 3	.800	20.32	.011	.28	.069	1.75						

NEC: CM • CEC: CM
UL AWM Style 2919
(30 V, +80 °C)
50 Ω Nom. Impedance
66% Velocity of Prop.
Conductor DCR (Nom):
15.0 Ω/1000' (49.2 Ω/km)

22 AWG • Polypropylene/LSZH

Stranded (7 x 30) TC Conductors • Polypropylene Insulation • Individually Beldfoil® Shielded Pairs • 22 AWG TC Drain Wire • LSZH Jacket														
8777SB	3	Chart 3	.273	6.93	.010	.25	.034	.86	30	98	55	180		

NEC: CMG-LS • CEC: CMG-LS
50 Ω Nom. Impedance
66% Velocity of Prop.
Conductor DCR (Nom):
15.0 Ω/1000' (49.2 Ω/km)

22 AWG • Polypropylene/LSZH

Stranded (7 x 30) TC Conductors • Polypropylene Insulation • Individually Beldfoil® Shielded Pairs • 22 AWG Stranded TC Drain Wire • Chrome LSZH Jacket														
8777NH	3	Chart 3	.280	7.00	.011	.28	.035	.89	30	98	55	180		Flame IEC 60332-3-24, Smoke IEC 6103, 50 Ω Nom. Impedance, 66% Velocity of Prop., Conductor DCR (Nom): 15.0 Ω/1000' (49.2 Ω/km)
8777LS	3	Chart 3	.450	11.50	.011	.28	.035/ .053	.89/ 1.35	30	98	55	180		Flame IEC 60332-3-24, Smoke IEC 6103, 50 Ω Nom. Impedance, 66% Velocity of Prop., Conductor DCR (Nom): 15.0 Ω/1000' (49.2 Ω/km) Steel Wire Armor
8778NH	6	Chart 3	.370	9.50	.011	.28	.035	.89	30	98	55	180		Flame IEC 60332-3-24, Smoke IEC 6103, 50 Ω Nom. Impedance, 66% Velocity of Prop., Conductor DCR (Nom): 15.0 Ω/1000' (49.2 Ω/km)
8778LS	6	Chart 3	.550	13.90	.011	.28	.035/ .053	.89/ 1.35	30	98	55	180		Flame IEC 60332-3-24, Smoke IEC 6103, 50 Ω Nom. Impedance, 66% Velocity of Prop., Conductor DCR (Nom): 15.0 Ω/1000' (49.2 Ω/km) Steel Wire Armor

TC = Tinned Copper • LSZH = Low Smoke Zero Halogen • PVC = Polyvinyl Chloride | Belden Color Code Charts can be found at page 344.

Audio, Control, and Instrumentation Cables

Individually Shielded Pairs • RS-485



Part No.	Pairs	Color Code	OD (Nom)		Insulation Thickness		Jacket Thickness		Capacitance				Additional Features/Ratings
			Inch	mm	Inch	mm	Inch	mm	Cond. - Cond.		Cond. - Shield		
									pF/Ft	pF/m	pF/Ft	pF/m	
22 AWG • FEP/Flamarrest®													
Stranded (7 x 30) TC Conductors • FEP Insulation • Individually Beldfoil® Shielded Pairs • 24 AWG TC Drain Wire • Natural Flamarrest Jacket Pairs Cabled on a Common Axis to Reduce Diameter.													
82723	2	Black-Red Green-White	.153	3.89	.007	.18	.017	.43	43	141	75	246	Plenum • Non-Conduit NEC: CMP • CEC: CMP FT6 300 V 45 Ω Nom. Impedance 66% Velocity of Prop. Conductor DCR (Nom): 14.7 Ω/1000' (48.2 Ω/km)
22 AWG • FEP/FEP													
Stranded (7 x 30) TC Conductors • FEP Insulation • Individually Beldfoil® Shielded Pairs • 24 AWG TC Drain Wire • Red FEP Jacket Pairs Cabled on a Common Axis to Reduce Diameter.													
88723	2	Black-Red Green-White	.148	3.76	.007	.18	.014	.36	35	115	67	220	Plenum • Non-Conduit NEC: CMP • CEC: CMP FT6 300 V 45 Ω Nom. Impedance 66% Velocity of Prop. Conductor DCR (Nom): 14.7 Ω/1000' (48.2 Ω/km)
22 AWG • FEP/Fluorocopolymer													
Stranded (7 x 30) TC Conductors • FEP Insulation • Individually Beldfoil® Shielded Pairs • 24 AWG TC Drain Wire • Red Fluorocopolymer Jacket Pairs Cabled on a Common Axis to Reduce Diameter.													
87723	2	Black-Red Green-White	.148	3.76	.007	.18	.014	.36	35	115	67	220	Plenum • Non-Conduit NEC: CMP • CEC: CMP FT6 300 V 45 Ω Nom. Impedance 66% Velocity of Prop. Conductor DCR (Nom): 14.7 Ω/1000' (48.2 Ω/km)

TC = Tinned Copper • FEP = Fluorinated Ethylene Propylene

Audio, Control, and Instrumentation Cables

Individually Shielded Pairs • Plenum



Part No.	Pairs	Color Code	OD (Nom)		Insulation Thickness		Jacket Thickness		Capacitance				Additional Features/Ratings
			Inch	mm	Inch	mm	Inch	mm	Cond. - Cond.		Cond. - Shield		
									pF/Ft	pF/m	pF/Ft	pF/m	
22 AWG • FEP/Flamarrest®													
Stranded (7 x 30) TC Conductors • FEP Insulation • Individually Beldfoil® Shielded Pairs • 22 AWG TC Drain Wire • Natural Flamarrest Jacket													
82777	3	Chart 3	.237	6.02									Plenum NEC: CMP • CEC: CMP FT6 46 Ω Nom. Impedance 62% Velocity of Prop. Conductor DCR (Nom): 14.7 Ω/1000' (48.2 Ω/km)
82778	6	Chart 3	3.14	7.98	.011	.28	.017	.43	35	115	76	249	
22 AWG • FEP/FEP													
Stranded (7 x 30) TC Conductors • FEP Insulation • Individually Beldfoil® Shielded Pairs • 22 AWG TC Drain Wire • Red FEP Jacket													
88777	3	Chart 3	.234	5.94									Plenum NEC: CMP • CEC: CMP FT6 50 Ω Nom. Impedance 62% Velocity of Prop. Conductor DCR (Nom): 14.7 Ω/1000' (48.2 Ω/km)
88778	6	Chart 3	.309	7.85	.010	.25	.014	.36	31	102	67	220	
22 AWG • FEP/Fluorocopolymer													
Stranded (7 x 30) TC Conductors • FEP Insulation • Individually Beldfoil® Shielded Pairs • 22 AWG TC Drain Wire • Red Fluorocopolymer Jacket													
87777	3	Chart 3	.234	5.94									Plenum NEC: CMP • CEC: CMP FT6 46 Ω Nom. Impedance 50% Velocity of Prop. Conductor DCR (Nom): 14.7 Ω/1000' (48.2 Ω/km)
87778	6	Chart 3	.309	7.85	.010	.25	.014	.36	31	102	67	220	

TC = Tinned Copper • FEP = Fluorinated Ethylene Propylene | Belden Color Code Charts can be found at page 344.

Audio, Control, and Instrumentation Cables

Individually Shielded Pairs

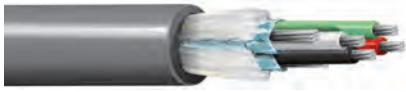

Part No.	Pairs	Color Code	OD (Nom)		Insulation Thickness		Jacket Thickness		Capacitance				Additional Features/Ratings
			Inch	mm	Inch	mm	Inch	mm	Cond. - Cond.		Cond. - Shield		
									pF/Ft	pF/m	pF/Ft	pF/m	
20 AWG • SR-PVC/PVC													
Stranded (7 x 28) TC Conductors • Semi-Rigid PVC Insulation • Individually Beldfoil® Shielded Pairs • 22 AWG TC Drain Wire • Chrome PVC Jacket													
9402	2	Black-Red, Green-White	.300	7.62	.010	.25	.041	1.04	55	180	95	312	NEC: CMG • CEC: CMG FT4 UL AWM Style 2464 (300 V, +80 °C)
20 AWG • Polypropylene/Polyethylene													
Stranded (10 x 32) TC Conductors • Polypropylene Insulation • Individually Beldfoil® Shielded Pairs • 22 AWG TC Drain Wire • Black High-Density Polyethylene Jacket													
9883	3	Chart 3	.340	8.64	.013	.33	.040	1.02	30	98	55	180	NEC: CMG • CEC: CMP FT4 350 V 50 Ω Nom. Impedance 66% Velocity of Prop Conductor DCR (Nom): 6.4 Ω/1000' (21.0 Ω/km)
9886	6	Chart 3	.455	11.56	.013	.33	.045	1.14					
20 AWG • Polypropylene/PVC													
Stranded (7 x 28) TC Conductors • Polypropylene Insulation • Individually Beldfoil® Shielded Pairs • 22 AWG TC Drain Wire • Chrome PVC Jacket													
9873	3	Chart 3	.341	8.66	.015	.38	.035	.89	30	98	55	180	NEC: CM • CEC: CM UL AWM Style 2919 (30 V, +80 °C) 50 Ω Nom. Impedance 66% Velocity of Prop Conductor DCR (Nom): 10.5 Ω/1000' (34.4 Ω/km)
9874	6	Chart 3	.445	11.30									
9875	9	Chart 3	.555	14.10	.015	.38	.052	1.32	30	98	55	180	NEC: CM • CEC: CM UL AWM Style 2919 (30 V, +80 °C) 50 Ω Nom. Impedance 66% Velocity of Prop Conductor DCR (Nom): 10.5 Ω/1000' (34.4 Ω/km)
9876	11	Chart 3	.600	15.24									
9877	12	Chart 3	.617	15.67									
9879	15	Chart 3	.689	17.50	.015	.38	.052	1.32					
18 AWG • Polypropylene/PVC													
Stranded (19 x 30) TC Conductors • Polypropylene Insulation • Individually Beldfoil® Shielded Pairs • 20 AWG TC Drain Wire • Chrome PVC Jacket													
9773	3	Chart 3	.404	10.26	.019	.48	.035	.89	30	98	55	180	NEC: CM • CEC: CM UL AWM Style 2919 (30 V, +80 °C) 50 Ω Nom. Impedance 66% Velocity of Prop Conductor DCR (Nom): 10.5 Ω/1000' (34.4 Ω/km)
9774	6	Chart 3	.560	14.22									
9775	9	Chart 3	.655	16.64	.019	.48	.052	1.32	30	98	55	180	NEC: CM • CEC: CM UL AWM Style 2919 (30 V, +80 °C) 50 Ω Nom. Impedance 66% Velocity of Prop Conductor DCR (Nom): 10.5 Ω/1000' (34.4 Ω/km)
9776	12	Chart 3	.735	18.67									
9777	15	Chart 3	.819	20.80									

TC = Tinned Copper • PVC = Polyvinyl Chloride | Belden Color Code Charts can be found at page 344.

UL Instrumentation Cables

300 V Power-Limited Tray Cables – Overview

Construction

Soft annealed bare or tinned copper with PVC flame retardant insulation and jacket. Other insulation and jacket options are available (see table below). Communication wire included on all multi-pair/multi-triad 1000 and 3000 series part numbers, 22 AWG (7 x 30) bare copper, orange PVC insulation. Nylon rip cord included in all PVC/PVC instrumentation cables.

Other Construction Options:

UL Listed for PLTC	
Insulation/Jacket	Max. Temp Rating
XLP/PVC	+90 °C
XLP/CPE	+90 °C
PVC/PVC	+105 °C
PVC/CPE	+105 °C
XLP/Haloarrest®	+90 °C

Armoring Capabilities

Belden also has the capability to protect electronic, instrumentation and control cables with interlocking or continuous armor and Belclad® corrugated protective metal tapes.

Application

Cable jackets are resistant to sunlight, moisture and vapor penetration. PVC/PVC constructions, with 3 conductors or more and 20 AWG or larger, are suitable for direct burial.

Unshielded

Twisted non-shielded pairs and triads provide a minimal OD allowing greater tray and conduit fill. Non-shielded instrument pairs may be utilized when recommended by the instrument manufacturer and used in a metallic conduit.

Overall Shield

Recommended for use in instrumentation applications where signals are transmitted in excess of 100 millivolts except in areas where high voltage and current sources create excessive noise interference. The Beldfoil® shield with drain wire provides 100% coverage for maximum shield effectiveness.

Individually Shielded and Overall Shielded

Individually shielded pairs or triads with an overall shield are recommended for use in instrumentation applications where optimum noise rejection is required. Individual pair/triad shields are fully isolated from each other and contain a separate drain wire for grounding to provide maximum protection from crosstalk and common mode interference. Cables with an overall shield provide additional electrostatic noise protection.

Specifications

- UL Subject 13
- UL Subject 2250
- NEC Article 725 Class 2 and Class 3 Circuits
- NEC Type PLTC Listed, which is approved for cable tray use in Class 1, Division 2, hazardous areas and non-hazardous areas, cable trays, raceways, conduit and supported by messenger wires.
- Sunlight-resistant.
- NEC Type ITC per Article 727. ITC cables may carry up to 5 amps at 150 V, which is significantly greater than that allowed for PLTC only cables. ITC cables may also be installed in specific applications, per the NEC, in addition to those allowed for PLTC.
- UL 1685 (UL 1581) Vertical Tray Flame Test comparable to IEEE 383-1974 (70,000 BTU/hr.) Flame Test.
- PVC/PVC constructions are CMG, FT4, IEEE 1202 and IEEE 383-2003 rated, and meet ICEA T-29-520 Flame Test.
- Design options – call 1-800-BELDEN1.

PLTC-ER/ITC-ER

As an option, Belden offers all PVC insulated, PVC jacketed instrumentation cables, and several other insulation and jackets, with a PLTC-ER (Exposed Run) and ITC-ER ratings.

Per NEC Article 725, a PLTC-ER rated cable may be installed in an industrial establishment between a cable tray and the utilization equipment or device. A PLTC-ER rated cable must meet the crush and impact requirements of UL Type MC cable. By eliminating the need for metal conduit and/or armor, using a PLTC-ER rated cable results in savings in both installation and maintenance.

Armoring Options

Code		
Overall Jacket Prefix	Armor Prefix	Base Part No.
3	4	4-digit base number

Overall Jacket

Code	Material
1	PVC
3	CPE
4	TPE
5	HDPE
7	Haloarrest

Armor

Code	Material
2	Aluminum Interlock
3	Steel Interlock
4	Aluminum Belclad®
5	Steel Belclad
6	Copper Belclad
8	Continuous Armor

Example: 343016A is cable part no. 3016A with CPE outer jacket and aluminum Belclad tape.

UL Instrumentation Cables
300 V Power-Limited Tray Cables

22 AWG Pairs



- UL PLTC, ITC
- Sunlight Res
- Oil Res

- NEC: CMG
- CEC: CMG FT4
- IEEE 1202/383
- ICEA T-29-520

Part No.	Pairs	Color Code	Pull Tension (Max)		Bend Radius (Min)		OD (Nom)		Jacket Thickness	
			Lbs	N	Inch	mm	Inch	mm	Inch	mm

22 AWG • Unshielded

Stranded (7 x 30) TC Conductors • PVC Insulation • PVC Jacket										
9407	1	E2	19	85	2.00	50.80	.198	5.03	.037	.94

22 AWG • Overall Beldfoil® Shield

Stranded (7 x 30) TC Conductors • PVC Insulation • PVC Jacket										
9322	1	E2	28	125	2.00	50.80	.201	5.10	.037	.94
9512	2	E2	46	205	3.00	76.20	.310	7.82		
9513	3	E2	63	280	3.25	82.55	.324	8.23	.042	1.07
9514	4	E2	80	356	3.50	88.90	.356	9.04		
9516	6	E2	118	525	4.25	107.95	.418	10.62		
9520	9	E2	172	765	4.75	120.65	.482	12.29		
9521	11	E2	200	890	5.35	135.89	.506	12.85	.053	1.35
9524	15	E2	280	1246	6.00	152.40	.594	15.09		
9526	19	E2	350	1557	6.33	160.78	.644	16.36		
9527	27	E2	500	2224	7.50	190.50	.763	19.38	.063	1.60

22 AWG • Individually Beldfoil® Shielded Pairs

Stranded (7 x 30) TC Conductors • PVC Insulation • PVC Jacket										
9328	2	E2	54	240	3.00	76.20	.323	8.20		
9329	3	E2	54	240	3.50	88.90	.341	8.66	.042	1.07
9330	4	E2	110	489	3.50	88.90	.372	9.45		
9331	6	E2	101	449	4.33	109.98	.457	11.61		
9332	9	E2	160	712	5.00	127.00	.530	13.46	.053	1.35
9333	11	E2	160	712	5.50	139.70	.592	15.04		
9335	19	E2	264	1174	6.50	165.10	.711	18.06	.063	1.60

TC = Tinned Copper • PVC = Polyvinyl Chloride | Belden Color Code Charts can be found at page 345.

UL Instrumentation Cables
300 V Power-Limited Tray Cables

22 AWG Pairs



- UL PLTC, ITC
- Sunlight Res
- Oil Res
- NEC: CMG
- CEC: CMG FT4
- IEEE 1202/383
- ICEA T-29-520

Part No.	Pairs	Color Code	Pull Tension (Max)		Bend Radius (Min)		OD (Nom)		Jacket Thickness	
			Lbs	N	Inch	mm	Inch	mm	Inch	mm

22 AWG • Overall Beldfoil® Shield • 22 AWG Orange Communication Wire

Stranded (7 x 30) BC Conductors • PVC Insulation • PVC Jacket										
3000A	2	E1	46	205	3.00	76.20	.310	7.87	.043	1.09
3004A	4	E1	80	356	3.50	88.90	.357	9.01	.042	1.07
3006A	8	E1	172	765	4.75	120.65	.450	11.43		
3008A	12	E1	210	934	5.00	127.00	.536	13.61	.053	1.35
3010A	16	E1	290	1290	6.00	152.40	.594	15.09		
3012A	24	E1	440	1957	7.50	190.50	.749	19.02	.065	1.65
3014A	50	E1	915	4070	9.50	241.30	1.017	25.80	.075	1.91

22 AWG • Individually Beldfoil® Shielded Pairs and Overall Beldfoil® Shield • 22 AWG Orange Communication Wire

Stranded (7 x 30) BC Conductors • PVC Insulation • PVC Jacket										
3001A	2	E1	54	240	3.25	82.55	.324	8.23	.042	1.07
3005A	4	E1	115	512	3.50	88.90	.360	9.14	.043	1.09
3007A	8	E1	250	1112	5.25	133.35	.497	12.62		
3009A	12	E1	300	1334	5.75	146.05	.570	14.48	.053	1.35
3011A	16	E1	350	1557	6.25	158.75	.674	17.12	.064	1.63
3013A	24	E1	540	2402	8.00	203.20	.800	20.32	.065	1.65
3015A	50	E1	1330	5916	10.50	266.70	1.050	26.67	.075	1.91

To Specify Conductor, Insulation and Jacket Options:		
1234	A	E
Start with Base Part No. (1000 and 3000 Series cables only)	Add or Modify for Conductor, Insulation, and Jacket. See table at right.	Add for Exposed Run Rating

Bare	Tinned	Insulation/Jacket	Bare	Tinned	Insulation/Jacket
A	B	PVC/PVC	Q	R	XLP/CPE
C	D	XLP/PVC	S	T	XLP/Haloarrest®

BC = Bare Copper • CPE = Chlorinated Polyethylene • PVC = Polyvinyl Chloride • XLP = Cross-Linked Polyethylene | Belden Color Code Charts can be found at page 345.

UL Instrumentation Cables
300 V Power-Limited Tray Cables

22 AWG Triads



- UL PLTC, ITC
- Sunlight Res
- Oil Res
- NEC: CMG
- CEC: CMG FT4
- IEEE 1202/383
- ICEA T-29-520

Part No.	Triads	Color Code	Pull Tension (Max)		Bend Radius (Min)		OD (Nom)		Jacket Thickness	
			Lbs	N	Inch	mm	Inch	mm	Inch	mm

22 AWG • Unshielded

Stranded (7 x 30) TC Conductors • PVC Insulation • PVC Jacket										
9491	1	E1	29	129	2.00	50.80	.208	5.28	.037	.94

22 AWG • Beldfoil® Shield

Stranded (7 x 30) TC Conductors • PVC Insulation • PVC Jacket										
9363	1	E1	29	129	2.00	50.80	.208	5.28	.037	.94

22 AWG Triads



- UL PLTC, ITC
- Sunlight Res
- Oil Res
- NEC: CMG
- CEC: CMG FT4
- IEEE 1202/383
- ICEA T-29-520

Part No.	Triads	Color Code	Pull Tension (Max)		Bend Radius (Min)		OD (Nom)		Jacket Thickness	
			Lbs	N	Inch	mm	Inch	mm	Inch	mm

22 AWG • Overall Beldfoil® Shield • 22 AWG Orange Communication Wire

Stranded (7 x 30) BC Conductors • PVC Insulation • PVC Jacket										
3002A	2	E1	62	276	3.50	88.90	.330	8.38	.043	1.09

22 AWG • Individually Beldfoil® Shielded Triads and Overall Beldfoil® Shield • 22 AWG Orange Communication Wire

Stranded (7 x 30) BC Conductors • PVC Insulation • PVC Jacket										
3003A	2	E1	82	365	3.25	82.55	.330	8.38	.043	1.09

To Specify Conductor, Insulation and Jacket Options:

1234	A	E
Start with Base Part No. (1000 and 3000 Series cables only)	Add or Modify for Conductor, Insulation, and Jacket. See table at right.	Add for Exposed Run Rating

Bare	Tinned	Insulation/Jacket	Bare	Tinned	Insulation/Jacket
A	B	PVC/PVC	Q	R	XLP/CPE
C	D	XLP/PVC	S	T	XLP/Haloarrest®

BC = Bare Copper • TC = Tinned Copper • PVC = Polyvinyl Chloride • XLP = Cross-Linked Polyethylene | Belden Color Code Charts can be found at page 345.

UL Instrumentation Cables
300 V Power-Limited Tray Cables

20 AWG Pairs



- UL PLTC, ITC
- Sunlight Res
- Oil Res
- NEC: CMG
- CEC: CMG FT4
- IEEE 1202/383
- ICEA T-29-520

Part No.	Pairs	Color Code	Pull Tension (Max)		Bend Radius (Min)		OD (Nom)		Jacket Thickness	
			Lbs	N	Inch	mm	Inch	mm	Inch	mm

20 AWG • Unshielded

Stranded (19 x 32) TC Conductors • PVC Insulation • PVC Jacket										
9408	1	E2	31	138	2.0	50.80	.214	5.44	.037	.94

20 AWG • Overall Beldfoil® Shield

Stranded (19 x 32) TC Conductors • PVC Insulation • PVC Jacket										
9320	1	E2	40	178	2.0	50.80	.217	5.51	.037	.94

20 AWG Pairs



- UL PLTC, ITC
- Sunlight Res
- Oil Res
- NEC: CMG
- CEC: CMG FT4
- IEEE 1202/383
- ICEA T-29-520

Part No.	Pairs	Color Code	Pull Tension (Max)		Bend Radius (Min)		OD (Nom)		Jacket Thickness	
			Lbs	N	Inch	mm	Inch	mm	Inch	mm

20 AWG • Overall Beldfoil® Shield • 22 AWG Orange Communication Wire

Stranded (7 x 28) BC Conductors • PVC Insulation • PVC Jacket										
1033A	1	E1	42	187	2.25	57.15	.213	5.41	.037	.94
3016A	2	E1	92	409	3.75	95.25	.332	8.43	.042	1.07
1056A	4	E1	135	601	4.25	107.95	.408	10.36		
1057A	8	E1	247	1099	5.00	127.00	.472	11.99	.053	1.35
1058A	12	E1	359	1597	6.00	152.40	.564	14.33		
1059A	16	E1	232	1032	6.50	165.10	.649	16.48		
1060A	24	E1	695	3092	8.25	209.55	.786	19.96	.064	1.63
1061A	36	E1	1031	4586	10.00	254.00	.960	24.38	.074	1.88
1062A	50	E1	1423	6330	11.50	292.10	1.117	28.37		

To Specify Conductor, Insulation and Jacket Options:		
1234	A	E
Start with Base Part No. (1000 and 3000 Series cables only)	Add or Modify for Conductor, Insulation, and Jacket. See table at right.	Add for Exposed Run Rating

Bare	Tinned	Insulation/Jacket	Bare	Tinned	Insulation/Jacket
A	B	PVC/PVC	Q	R	XLP/CPE
C	D	XLP/PVC	S	T	XLP/Haloarrest®

BC = Bare Copper • TC = Tinned Copper • CPE = Chlorinated Polyethylene • PVC = Polyvinyl Chloride • XLP = Cross-Linked Polyethylene | Belden Color Code Charts can be found at page 345.

UL Instrumentation Cables
300 V Power-Limited Tray Cables

20 AWG Pairs



- UL PLTC, ITC
- Sunlight Res
- Oil Res
- NEC: CMG
- CEC: CMG FT4
- IEEE 1202/383
- ICEA T-29-520

Part No.	Pairs	Color Code	Pull Tension (Max)		Bend Radius (Min)		OD (Nom)		Jacket Thickness	
			Lbs	N	Inch	mm	Inch	mm	Inch	mm

20 AWG • Individually Beldfoil® Shielded Pairs and Overall Beldfoil® Shield • 22 AWG Orange Communication Wire

Stranded (7 x 28) BC Conductors • PVC Insulation • PVC Jacket										
1075A	2	E1	97	431	3.75	95.25	.337	8.56	.042	1.07
1076A	4	E1	171	761	4.50	114.30	.411	10.44	.053	1.35
1077A	8	E1	320	1423	5.50	139.70	.514	13.06		
1078A	12	E1	468	2082	6.75	171.45	.637	16.18		
1079A	16	E1	617	2745	7.50	190.50	.704	17.88	.064	1.63
1091A	20	E1	765	3403	8.25	209.55	.780	19.81		
1080A	24	E1	914	4066	9.00	228.60	.863	21.92		
1081A	36	E1	1359	6045	10.50	266.70	1.035	26.29	.074	1.88
1082A	50	E1	1878	8354	12.75	323.85	1.215	30.86		

20 AWG Triads



- UL PLTC, ITC
- Sunlight Res
- Oil Res
- NEC: CMG
- CEC: CMG FT4
- IEEE 1202/383
- ICEA T-29-520

Part No.	Triads	Color Code	Pull Tension (Max)		Bend Radius (Min)		OD (Nom)		Jacket Thickness	
			Lbs	N	Inch	mm	Inch	mm	Inch	mm

20 AWG • Unshielded

Stranded (19 x 32) TC Conductors • PVC Insulation • PVC Jacket										
9492	1	E1	46	205	2.25	57.15	.225	5.72	.037	.94

20 AWG • Beldfoil® Shield

Stranded (19 x 32) TC Conductors • PVC Insulation • PVC Jacket										
9364	1	E1	46	205	2.25	57.15	.228	5.79	.037	.94

To Specify Conductor, Insulation and Jacket Options:

1234			A			E		
Start with Base Part No. (1000 and 3000 Series cables only)			Add or Modify for Conductor, Insulation, and Jacket. See table at right.			Add for Exposed Run Rating		

Bare	Tinned	Insulation/Jacket	Bare	Tinned	Insulation/Jacket
A	B	PVC/PVC	Q	R	XLP/CPE
C	D	XLP/PVC	S	T	XLP/Haloarrest®

BC = Bare Copper • TC = Tinned Copper • CPE = Chlorinated Polyethylene • PVC = Polyvinyl Chloride • XLP = Cross-Linked Polyethylene | Belden Color Code Charts can be found at page 345.

UL Instrumentation Cables

300 V Power-Limited Tray Cables

20 AWG Triads



- UL PLTC, ITC
- Sunlight Res
- Oil Res
- NEC: CMG
- CEC: CMG FT4
- IEEE 1202/383
- ICEA T-29-520

Part No.	Triads	Color Code	Pull Tension (Max)		Bend Radius (Min)		OD (Nom)		Jacket Thickness	
			Lbs	N	Inch	mm	Inch	mm	Inch	mm

20 AWG • Beldfoil® Shield • 22 AWG Orange Communication Wire

Stranded (7 x 28) BC Conductors • PVC Insulation • PVC Jacket										
1526A	1	E1	42	187	2.20	55.88	.215	5.46	.037	.94
3017A	2	E1	97	431	3.60	91.44	.360	9.14		
3020A	4	E1	174	774	4.75	120.65	.470	11.94	.055	1.40
3021A	8	E1	330	1468	5.00	127.00	.560	14.22		
3022A	12	E1	485	2157	7.00	177.80	.710	18.03	.066	1.68
3023A	16	E1	600	2669	7.75	196.85	.821	20.85	.064	1.63
3024A	24	E1	920	4092	9.25	234.95	1.031	26.19	.074	1.88

20 AWG • Individually Beldfoil® Shielded Triads and Overall Beldfoil® Shield • 22 AWG Orange Communication Wire

Stranded (7 x 28) BC Conductors • PVC Insulation • PVC Jacket										
3018A	2	E1	102	454	3.75	95.25	.372	9.45	.055	1.40
1083A	4	E1	228	1014	4.50	114.30	.451	11.46	.053	1.35
1084A	8	E1	432	1922	5.75	146.05	.575	10.81		
1085A	12	E1	636	2929	7.15	181.61	.714	18.14	.064	1.63
1092A	16	E1	841	3741	7.90	200.66	.793	20.14		
1086A	24	E1	1250	5560	9.90	251.46	.992	25.20		
3067A	36	E1	1875	8340	13.00	330.20	1.292	32.82	.074	1.88

To Specify Conductor, Insulation and Jacket Options:					
1234		A	E		
Start with Base Part No. (1000 and 3000 Series cables only)		Add or Modify for Conductor, Insulation, and Jacket. See table at right.	Add for Exposed Run Rating		
Bare	Tinned	Insulation/Jacket	Bare	Tinned	Insulation/Jacket
A	B	PVC/PVC	Q	R	XLP/CPE
C	D	XLP/PVC	S	T	XLP/Haloarrest®

BC = Bare Copper • TC = Tinned Copper • CPE = Chlorinated Polyethylene • PVC = Polyvinyl Chloride • XLP = Cross-Linked Polyethylene | Belden Color Code Charts can be found at page 345.

UL Instrumentation Cables
300 V Power-Limited Tray Cables

18 AWG Pairs



- UL PLTC, ITC
- Sunlight Res
- Oil Res
- NEC: CMG
- CEC: CMG FT4
- IEEE 1202/383
- ICEA T-29-520

Part No.	Pairs	Color Code	Pull Tension (Max)		Bend Radius (Min)		OD (Nom)		Jacket Thickness	
			Lbs	N	Inch	mm	Inch	mm	Inch	mm

18 AWG • Unshielded

Stranded (19 x 30) TC Conductors • PVC Insulation • PVC Jacket										
9409	1	E2	19	85	2.25	57.15	.230	5.84	.037	.94

18 AWG • Overall Beldfoil® Shield

Stranded (19 x 30) TC Conductors • PVC Insulation • PVC Jacket										
9318	1	E2	60	267	2.25	57.15	.233	5.92	.037	.94
9552	2	E2	65	289	3.70	93.98	.368	9.34	.042	1.07
9553	3	E2	145	645	4.10	104.14	.411	10.44		
9554	4	E2	187	832	4.50	114.30	.447	11.35		
9556	6	E2	270	1201	5.00	127.00	.497	12.62	.053	1.35
9559	9	E2	395	1757	5.80	147.32	.579	14.71		
9563	11	E2	478	2126	6.75	171.45	.665	16.89		
9565	15	E2	640	2847	7.50	190.50	.739	18.77	.063	1.60

18 AWG • Individually Beldfoil® Shielded Pairs

Stranded (19 x 30) TC Conductors • PVC Insulation • PVC Jacket										
9368	2	E2	125	556	3.75	95.25	.378	9.60	.042	1.07
9369	3	E2	220	979	4.25	107.95	.423	10.74		
3029A	4	E1	296	1317	4.50	114.30	.461	11.71		
9388	4	E2	296	1317	4.60	116.84	.461	11.71	.053	1.35
9389	6	E2	440	1957	5.25	133.35	.538	13.67		
9390	9	E2	666	2963	6.50	165.10	.652	16.56		
9391	11	E2	815	3625	7.25	184.15	.729	18.52	.064	1.63
9392	15	E2	1100	4893	8.00	203.20	.808	20.52		

TC = Tinned Copper • PVC = Polyvinyl Chloride | Belden Color Code Charts can be found at page 345.

UL Instrumentation Cables

300 V Power-Limited Tray Cables

18 AWG Pairs



- UL PLTC, ITC
- Sunlight Res
- Oil Res
- NEC: CMG
- CEC: CMG FT4
- IEEE 1202/383
- ICEA T-29-520

Part No.	Pairs	Color Code	Pull Tension (Max)		Bend Radius (Min)		OD (Nom)		Jacket Thickness	
			Lbs	N	Inch	mm	Inch	mm	Inch	mm

18 AWG • Overall Beldfoil® Shield • 22 AWG Orange Communication Wire

Stranded (7 x 26) BC Conductors • PVC Insulation • PVC Jacket										
1032A	1	E1	67	298	2.50	63.50	.233	5.92	.037	.94
3025A	2	E1	121	538	3.50	88.90	.375	9.53	.042	1.07
1529A	3	E1	165	734	4.25	107.95	.415	10.54		
1466A	4	E1	211	939	4.50	114.30	.452	11.48	.053	1.35
1467A	8	E1	390	1735	5.50	139.70	.523	13.28		
1468A	12	E1	560	2491	6.75	171.45	.673	17.09	.064	1.63
3034A	16	E1	640	2847	7.25	184.15	.713	18.11	.066	1.68
1471A	24	E1	1105	4915	9.25	234.95	.932	23.67		
1472A	36	E1	1644	7313	10.50	266.70	1.062	26.97	.074	1.88
3041A	50	E1	2240	9964	12.75	323.85	1.240	31.50		

18 AWG • Individually Beldfoil® Shielded Pairs and Overall Beldfoil® Shield • 22 AWG Orange Communication Wire

Stranded (7 x 26) BC Conductors • PVC Insulation • PVC Jacket										
1474A	2	E1	149	663	4.00	101.60	.408	10.16		
1475A	4	E1	267	1188	4.75	120.65	.468	11.89	.053	1.35
1476A	8	E1	501	2229	6.00	152.40	.594	15.10		
1477A	12	E1	779	3465	7.25	184.15	.737	18.72	.064	1.63
3035A	16	E1	725	3225	8.50	215.90	.836	21.20		
1480A	24	E1	1443	6419	10.25	260.35	1.019	25.88	.074	1.88
1481A	36	E1	2148	9555	11.75	298.45	1.163	29.54		
3042A	50	E1	2935	13056	14.00	355.60	1.389	35.28	.084	2.13

To Specify Conductor, Insulation and Jacket Options:		
1234	A	E
Start with Base Part No. (1000 and 3000 Series cables only)	Add or Modify for Conductor, Insulation, and Jacket. See table at right.	Add for Exposed Run Rating

Bare	Tinned	Insulation/Jacket	Bare	Tinned	Insulation/Jacket
A	B	PVC/PVC	Q	R	XLP/CPE
C	D	XLP/PVC	S	T	XLP/Haloarrest®

BC = Bare Copper • CPE = Chlorinated Polyethylene • PVC = Polyvinyl Chloride • XLP = Cross-Linked Polyethylene | Belden Color Code Charts can be found at page 345.

UL Instrumentation Cables
300 V Power-Limited Tray Cables

18 AWG Triads



- UL PLTC, ITC
- Sunlight Res
- Oil Res
- NEC: CMG
- CEC: CMG FT4
- IEEE 1202/383
- ICEA T-29-520

Part No.	Triads	Color Code	Pull Tension (Max)		Bend Radius (Min)		OD (Nom)		Jacket Thickness	
			Lbs	N	Inch	mm	Inch	mm	Inch	mm

18 AWG • Unshielded

Stranded (19 x 30) TC Conductors • PVC Insulation • PVC Jacket										
9493	1	E1	62	276	2.25	57.15	.242	6.15	.037	.94

18 AWG • Beldfoil® Shield

Stranded (19 x 30) TC Conductors • PVC Insulation • PVC Jacket										
9365	1	E1	74	329	2.50	63.50	.245	6.22	.037	.94

18 AWG Triads



- UL PLTC, ITC
- Sunlight Res
- Oil Res
- NEC: CMG
- CEC: CMG FT4
- IEEE 1202/383
- ICEA T-29-520

Part No.	Triads	Color Code	Pull Tension (Max)		Bend Radius (Min)		OD (Nom)		Jacket Thickness	
			Lbs	N	Inch	mm	Inch	mm	Inch	mm

18 AWG • Overall Beldfoil® Shield • 22 AWG Orange Communication Wire

Stranded (7 x 26) BC Conductors • PVC Insulation • PVC Jacket										
1036A	1	E1	90	400	2.40	60.96	.236	5.99	.037	.94
3027A	2	E1	165	734	4.25	107.95	.420	10.67	.055	1.40
3030A	4	E1	240	1068	4.50	114.30	.521	13.20	.064	1.63
3032A	8	E1	501	2229	5.75	146.05	.580	14.70	.077	1.96
3036A	16	E1	1050	4671	9.00	228.60	.900	22.86	.077	1.96
3038A	24	E1	1450	6450	10.25	260.35	1.020	25.91	.077	1.96

18 AWG • Individually Beldfoil® Shielded Triads and Overall Beldfoil® Shield • 22 AWG Orange Communication Wire

Stranded (7 x 26) BC Conductors • PVC Insulation • PVC Jacket										
3028A	2	E1	175	778	4.50	114.30	.450	11.43	.055	1.40
3031A	4	E1	255	1134	5.25	133.35	.533	13.50	.053	1.35
3033A	8	E1	560	2491	6.50	165.10	.654	16.50	.064	1.63
3068A	12	E1	800	3559	8.50	215.90	.840	21.30	.063	1.60
3037A	16	E1	1320	5872	10.50	266.70	.974	24.70	.074	1.88
3039A	24	E1	1620	7206	11.25	285.75	1.200	30.50	.074	1.88

To Specify Conductor, Insulation and Jacket Options:		
1234	A	E
Start with Base Part No. (1000 and 3000 Series cables only)	Add or Modify for Conductor, Insulation, and Jacket. See table at right.	Add for Exposed Run Rating

Bare	Tinned	Insulation/Jacket	Bare	Tinned	Insulation/Jacket
A	B	PVC/PVC	Q	R	XLP/CPE
C	D	XLP/PVC	S	T	XLP/Haloarrest®

BC = Bare Copper • TC = Tinned Copper • CPE = Chlorinated Polyethylene • PVC = Polyvinyl Chloride • XLP = Cross-Linked Polyethylene | Belden Color Code Charts can be found at page 345.

UL Instrumentation Cables
300 V Power-Limited Tray Cables

16 AWG Pairs



- UL PLTC, ITC
- Sunlight Res
- Oil Res
- NEC: CMG
- CEC: CMG FT4
- IEEE 1202/383
- ICEA T-29-520

Part No.	Pairs	Color Code	Pull Tension (Max)		Bend Radius (Min)		OD (Nom)		Jacket Thickness	
			Lbs	N	Inch	mm	Inch	mm	Inch	mm

16 AWG • Unshielded

Stranded (19 x 29) TC Conductors • PVC Insulation • PVC Jacket										
9410	1	E2	78	347	2.50	63.50	.254	6.45	0.37	.94
Stranded (7 x 24) BC Conductors • PVC Insulation • PVC Jacket										
1035A	1	E1	71	316	2.50	63.50	.254	6.45	0.37	.94

16 AWG • Beldfoil® Shield

Stranded (19 x 29) TC Conductors • PVC Insulation • PVC Jacket										
9316	1	E2	90	400	2.50	63.50	.256	6.50	0.37	.94

16 AWG Pairs



- UL PLTC, ITC
- Sunlight Res
- Oil Res
- NEC: CMG
- CEC: CMG FT4
- IEEE 1202/383
- ICEA T-29-520

Part No.	Pairs	Color Code	Pull Tension (Max)		Bend Radius (Min)		OD (Nom)		Jacket Thickness	
			Lbs	N	Inch	mm	Inch	mm	Inch	mm

16 AWG • Overall Beldfoil® Shield • 22 AWG Orange Communication Wire

Stranded (7 x 24) BC Conductors • PVC Insulation • PVC Jacket										
1030A	1	E1	94	418	2.50	63.50	.257	6.53	.037	.94
3043A	2	E1	83	369	4.50	114.30	.437	11.10		
1528A	3	E1	250	1112	4.75	120.65	.457	11.61	.053	1.35
1484A	4	E1	330	1468	5.00	127.00	.495	12.57		
1485A	8	E1	616	2740	6.00	152.40	.597	15.16		
1486A	12	E1	892	3966	7.50	190.50	.741	18.80	.064	1.63
3050A	16	E1	661	2940	8.50	215.90	.831	21.10		
1489A	24	E1	1749	7780	10.50	266.70	1.032	26.20	.074	1.88
1490A	36	E1	2606	11592	11.75	298.45	1.178	29.80		
3056A	50	E1	3615	16080	15.50	393.70	1.550	39.37	.088	2.24

To Specify Conductor, Insulation and Jacket Options:		
1234	A	E
Start with Base Part No. (1000 and 3000 Series cables only)	Add or Modify for Conductor, Insulation, and Jacket. See table at right.	Add for Exposed Run Rating

Bare	Tinned	Insulation/Jacket	Bare	Tinned	Insulation/Jacket
A	B	PVC/PVC	Q	R	XLP/CPE
C	D	XLP/PVC	S	T	XLP/Haloarrest®

BC = Bare Copper • TC = Tinned Copper • CPE = Chlorinated Polyethylene • PVC = Polyvinyl Chloride • XLP = Cross-Linked Polyethylene | Belden Color Code Charts can be found at page 345.

UL Instrumentation Cables

300 V Power-Limited Tray Cables

16 AWG Pairs



- UL PLTC, ITC
- Sunlight Res
- Oil Res
- NEC: CMG
- CEC: CMG FT4
- IEEE 1202/383
- ICEA T-29-520

Part No.	Pairs	Color Code	Pull Tension (Max)		Bend Radius (Min)		OD (Nom)		Jacket Thickness	
			Lbs	N	Inch	mm	Inch	mm	Inch	mm

16 AWG • Individually Beldfoil® Shielded Pairs and Overall Beldfoil® Shield • 22 AWG Orange Communication Wire

Stranded (7 x 24) BC Conductors • PVC Insulation • PVC Jacket										
1492A	2	E1	232	1032	4.50	114.30	.450	11.43	.053	1.35
1493A	4	E1	420	1868	5.00	127.00	.512	13.11	.055	1.40
1494A	8	E1	795	3536	7.00	177.80	.687	17.50	.066	1.68
1495A	12	E1	1170	5204	8.25	209.55	.822	20.73	.074	1.88
3051A	16	E1	661	2940	10.00	254.00	.936	23.77	.084	2.13
1498A	24	E1	2296	10213	11.50	292.10	1.149	29.18	.088	2.24
1499A	36	E1	3167	14088	13.50	342.90	1.334	33.88		
3057A	50	E1	2066	9190	16.00	406.40	1.600	40.64		

16 AWG Triads



- UL PLTC, ITC
- Sunlight Res
- Oil Res
- NEC: CMG
- CEC: CMG FT4
- IEEE 1202/383
- ICEA T-29-520

Part No.	Triads	Color Code	Pull Tension (Max)		Bend Radius (Min)		OD (Nom)		Jacket Thickness	
			Lbs	N	Inch	mm	Inch	mm	Inch	mm

16 AWG • Unshielded

Stranded (19 x 29) TC Conductors • PVC Insulation • PVC Jacket										
9494	1	E1	91	405	2.75	69.85	.268	6.81	.037	.94
Stranded (7 x 24) BC Conductors • PVC Insulation • PVC Jacket										
1034A	1	E1	107	476	2.75	69.85	.268	6.81	.037	.94

16 AWG • Beldfoil® Shield

Stranded (19 x 29) TC Conductors • PVC Insulation • PVC Jacket										
9366	1	E1	116	516	2.75	69.85	.270	6.86	.037	.94

To Specify Conductor, Insulation and Jacket Options:

1234			A			E		
Start with Base Part No. (1000 and 3000 Series cables only)			Add or Modify for Conductor, Insulation, and Jacket. See table at right.			Add for Exposed Run Rating		
Bare	Tinned	Insulation/Jacket	Bare	Tinned	Insulation/Jacket	Bare	Tinned	Insulation/Jacket
A	B	PVC/PVC	Q	R	XLP/CPE			
C	D	XLP/PVC	S	T	XLP/Haloarrest®			

BC = Bare Copper • TC = Tinned Copper • CPE = Chlorinated Polyethylene • PVC = Polyvinyl Chloride • XLP = Cross-Linked Polyethylene | Belden Color Code Charts can be found at page 345.

UL Instrumentation Cables
300 V Power-Limited Tray Cables

16 AWG Triads



- UL PLTC, ITC
- Sunlight Res
- Oil Res
- NEC: CMG
- CEC: CMG FT4
- IEEE 1202/383
- ICEA T-29-520

Part No.	Triads	Color Code	Pull Tension (Max)		Bend Radius (Min)		OD (Nom)		Jacket Thickness	
			Lbs	N	Inch	mm	Inch	mm	Inch	mm

16 AWG • Overall Beldfoil® Shield • 22 AWG Orange Communication Wire

Stranded (7 x 24) BC Conductors • PVC Insulation • PVC Jacket										
1031A	1	E1	130	578	2.75	69.85	.271	6.88	.037	.94
3044A	2	E1	259	1152	4.75	120.65	.483	12.27	.053	1.35
3046A	4	E1	473	2104	5.75	146.05	.570	14.40		
3048A	8	E1	902	4012	7.50	190.50	.760	19.30	.063	1.60
3052A	16	E1	1758	7820	11.25	285.75	1.032	26.21		
3054A	24	E1	2615	11632	11.75	298.45	1.180	29.90	.074	1.88

16 AWG • Individually Beldfoil® Shielded Triads and Overall Beldfoil® Shield • 22 AWG Orange Communication Wire

Stranded (7 x 24) BC Conductors • PVC Insulation • PVC Jacket										
3045A	2	E1	304	1352	5.00	127.00	.506	12.80	.053	1.35
3047A	4	E1	563	2504	6.00	152.40	.569	14.45		
3049A	8	E1	1081	4809	8.00	203.20	.764	19.41	.064	1.63
3069A	12	E1	1500	6672	10.00	254.00	.998	25.35		
3053A	16	E1	2117	9417	11.50	292.10	1.150	29.20	.074	1.88
3055A	24	E1	3153	14025	13.25	336.55	1.320	33.53	.084	2.13

To Specify Conductor, Insulation and Jacket Options:		
1234	A	E
Start with Base Part No. (1000 and 3000 Series cables only)	Add or Modify for Conductor, Insulation, and Jacket. See table at right.	Add for Exposed Run Rating

Bare	Tinned	Insulation/Jacket	Bare	Tinned	Insulation/Jacket
A	B	PVC/PVC	Q	R	XLP/CPE
C	D	XLP/PVC	S	T	XLP/Haloarrest®

BC = Bare Copper • CPE = Chlorinated Polyethylene • PVC = Polyvinyl Chloride • XLP = Cross-Linked Polyethylene | Belden Color Code Charts can be found at page 345.

UL Instrumentation Cables
300 V Power-Limited Tray Cables

14 AWG Pairs



- UL PLTC, ITC
- Sunlight Res
- Oil Res
- NEC: CL3R
- CEC: CMG FT4
- IEEE 1202/383
- ICEA T-29-520

Part No.	Pairs	Color Code	Pull Tension (Max)		Bend Radius (Min)		OD (Nom)		Jacket Thickness	
			Lbs	N	Inch	mm	Inch	mm	Inch	mm

14 AWG • Unshielded

Stranded (42 x 30) TC Conductors • PVC Insulation • PVC Jacket										
9411	1	E2	124	552	3.25	82.55	.322	8.18	.042	1.07

14 AWG • Beldfoil® Shield

Stranded (42 x 30) TC Conductors • PVC Insulation • PVC Jacket										
9314	1	E2	140	623	3.25	82.55	.324	8.23	.042	1.07

14 AWG Triads



- UL PLTC, ITC
- Sunlight Res
- Oil Res
- NEC: CL3R
- CEC: CMG FT4
- IEEE 1202/383
- ICEA T-29-520

Part No.	Triads	Color Code	Pull Tension (Max)		Bend Radius (Min)		OD (Nom)		Jacket Thickness	
			Lbs	N	Inch	mm	Inch	mm	Inch	mm

14 AWG • Unshielded

Stranded (42 x 30) TC Conductors • PVC Insulation • PVC Jacket										
9495	1	E1	186	827	3.50	88.90	.340	8.64	.042	1.07

14 AWG • Beldfoil® Shield

Stranded (42 x 30) TC Conductors • PVC Insulation • PVC Jacket										
9367	1	E1	188	836	3.50	88.90	.343	8.71	.042	1.07

TC = Tinned Copper • PVC = Polyvinyl Chloride | Belden Color Code Charts can be found at page 345.

UL Instrumentation Cables
300 V Power-Limited Tray Cables

12 AWG Pairs



- UL PLTC, ITC
- Sunlight Res
- Oil Res
- NEC: CL3R
- CEC: CMG FT4
- IEEE 1202/383
- ICEA T-29-520

Part No.	Pairs	Color Code	Pull Tension (Max)		Bend Radius (Min)		OD (Nom)		Jacket Thickness	
			Lbs	N	Inch	mm	Inch	mm	Inch	mm

12 AWG • Unshielded

Stranded (65 x 30) TC Conductors • PVC Insulation • PVC Jacket										
9412	1	E2	197	876	4.25	107.95	.370	9.40	.042	1.07

12 AWG • Beldfoil® Shield

Stranded (65 x 30) TC Conductors • PVC Insulation • PVC Jacket										
9312	1	E2	225	1001	4.25	107.95	.373	9.47	.042	1.07

12 AWG Triads



- UL PLTC, ITC
- Sunlight Res
- Oil Res
- NEC: CL3R
- CEC: CMG FT4
- IEEE 1202/383
- ICEA T-29-520

Part No.	Triads	Color Code	Pull Tension (Max)		Bend Radius (Min)		OD (Nom)		Jacket Thickness	
			Lbs	N	Inch	mm	Inch	mm	Inch	mm

12 AWG • Unshielded

Stranded (7 x 20) BC Conductors • PVC Insulation • PVC Jacket										
3102A	1	E1	315	1401	3.50	88.90	.432	11.00	0.53	1.35

To Specify Conductor, Insulation and Jacket Options:		
1234	A	E
Start with Base Part No. (1000 and 3000 Series cables only)	Add or Modify for Conductor, Insulation, and Jacket. See table at right.	Add for Exposed Run Rating

Bare	Tinned	Insulation/Jacket	Bare	Tinned	Insulation/Jacket
A	B	PVC/PVC	Q	R	XLP/CPE
C	D	XLP/PVC	S	T	XLP/Haloarrest®

BC = Bare Copper • TC = Tinned Copper • CPE = Chlorinated Polyethylene • PVC = Polyvinyl Chloride • XLP = Cross-Linked Polyethylene | Belden Color Code Charts can be found at page 345.

UL Instrumentation Cable

Thermocouple Extension Cable and Thermocouple Wire – Overview

Construction Thermocouple Extension Cable

Conductor material determined by the thermocouple extension wire type. FEP or PVC insulated with FEP or PVC jacket. Nylon rip cord included in all PVC-jacketed thermocouple extension cables. Communication wire included on all multi-pair, PVC constructions – 22 AWG (7 x 30) bare copper orange PVC insulation.

NOTE: The temperature ranges in Table A are applicable only to the thermocouple conductors and not to the cable. The cable must never be exposed to temperatures higher than the maximum temperature ratings shown in Table B.

Table B: Other Insulation/Jacket Options

UL Listed for PLTC	
Insulation/Jacket	Max. Temp Rating
XLP/PVC	+90 °C
XLP/CPE	+90 °C
PVC/PVC	+105 °C
PVC/CPE	+105 °C
XLP/Haloarrest®	+90 °C
FEP/FEP	+200 °C

Application

Unshielded

Parallel non-shielded extension wire may be utilized in low noise environments when recommended by the instrument manufacturer.

Overall Shield

Recommended, except in areas where high voltage and current sources create excessive noise interference. The Beldfoil® shield with drain wire provides 100% coverage for maximum shield effectiveness.

Individually Shielded

Individually shielded pairs are recommended for use in applications where optimum noise rejection is required.

PVC Insulated, PVC Jacketed Cable Specifications

- UL Subject 13
- UL 1685 (UL 1581) Vertical Tray Flame Test comparable to IEEE 383-1974 (70,000 BTU) Flame Test
- ANSI/MC 96.1-1982
- NEC CMG
- NEC Type PLTC Listed, which is approved for cable tray use in Class 1, Division 2, hazardous areas and non-hazardous areas, cable trays, raceways, conduit and supported by messenger wires.

- NEC Type ITC Listed, which is approved for cable tray use, raceways hazardous locations according to Articles 501, 502, 503 and 504; or as aerial on a cable messenger, and under raised floors in control rooms and rack rooms where arranged to prevent damage to the cable. Usages are allowed based on qualified persons servicing all installations.
- PVC/PVC constructions are CMG, FT4, IEEE 1202 and IEEE 383-2003 rated, and meet ICEA T-29-520 Flame Test.
- Optional: PLTC-ER/ITC-ER
- UL 1277 TC versions approved for use in Class 1 trays available as special.

Shielded Twisted Pair (FEP insulated, FEP jacketed cable specifications)

- UL Subject 13
- NFPA 262 (UL 910 Steiner Tunnel Flame Test) comparable to FT6 Flame Test
- ANSI/MC 96.1-1982
- NEC Type CL3P/PLTC Listed, which is approved for use in ducts, plenums and other space used for environmental air.
- UL 1277 TC versions approved for use in Class 1 trays available as special.

Thermocouple Wire

Conductor material determined by the thermocouple type. FEP insulated and jacketed flat constructions.

FEP thermocouple wire is impervious to chemical attack and is flame retardant.

Table A: Thermocouple Identification and Limits of Error – Reference Junction 0 °C*

ANSI Symbol	Temperature Range (°C) (conductor only)	Limits of Error Standard (°C)	Jacket Color	Insulation Color Code		Conductor Identification	
				Positive (+)	Negative (-)	Positive (+)	Negative (-)
E	0 to 340 340 to 540	±1.7 °C ±.50%	Brown	Purple	Red	Chromel® Non-magnetic	Constantan Silver Color
J	0 to 293 293 to 480	±2.2 °C ±.75%	Brown	White	Red	Iron Magnetic	Constantan Non-magnetic
K	0 to 293 293 to 980	±2.2 °C ±.75%	Brown	Yellow	Red	Chromel Non-magnetic	Alumel® Magnetic
T	0 to 133 133 to 260	±1.0 °C ±.75%	Brown	Blue	Red	Copper Copper Color	Constantan Non-magnetic
EX	0 to 200	±1.7 °C	Purple	Purple	Red	Chromel	Constantan
JX	0 to 200	±2.2 °C	Black	White	Red	Iron	Constantan
KX	0 to 200	±2.2 °C	Yellow	Yellow	Red	Chromel	Alumel
TX	0 to 200	±1.0 °C	Blue	Blue	Red	Copper	Constantan

Limits of error per ANSI MC96.1-1982. Limits shown do not include system or installation error. Percentages refer to the temperature being measured.

* The Temperature Range and Limits of Error are for standard grade thermocouples, Reference ANSI MC96.1-1982 for special grade thermocouples.

The Temperature Ranges for type E, J, K and T thermocouple wires listed above pertain to 20 AWG wire.

Additional constructions available upon request.

CPE = Chlorinated Polyethylene • FEP = Fluorinated Ethylene Propylene • PVC = Polyvinyl Chloride • XLP = Cross-Linked Polyethylene

UL Instrumentation Cables

Thermocouple Extension Cables

Extension Cable



- UL PLTC, ITC
- Sunlight Res
- Oil Res
- +105 °C
- NEC: CMG
- CEC: CMG FT4
- IEEE 1202/383
- ICEA T-29-520

Part No.	ANSI Type	Pairs	Color Code	Jacket Color	Insulation Thickness		OD (Nom)	
					Inch	mm	Inch	mm

20 AWG Solid Conductors • Overall Beldfoil® Shield

PVC Insulation • PVC Jacket								
3111A	JX	1	White, Red	Black				
3112A	KX	1	Yellow, Red	Yellow	.016	.41	.206	5.23
3113A	TX	1	Blue, Red	Blue				

20 AWG Solid Conductors • Individually Beldfoil® Shielded Pairs + Overall Beldfoil® Shield

PVC Insulation • PVC Jacket								
3115A	JX	2	White, Red	Black	.016	.41	.332	8.43
1006A	JX	4	White, Red	Black	.016	.41	.383	9.73
1012A	KX	4	Yellow, Red	Yellow	.016	.41	.383	9.73
1013A	KX	8	Yellow, Red	Yellow	.016	.41	.503	12.78

16 AWG Solid Conductors • Overall Beldfoil® Shield

PVC Insulation • PVC Jacket								
1101A	EX	1	Purple, Red	Purple				
1000A	JX	1	White, Red	Black	.017	.43	.248	6.30
1018A	KX	1	Yellow, Red	Yellow				
1023A	TX	1	Blue, Red	Blue				

PVC = Polyvinyl Chloride

UL Instrumentation Cables

High-Temperature Thermocouple Extension Cables and Thermocouple Wire

High-Temperature Extension Cable



- UL PLTC
- Sunlight Res
- Oil Res
- +200 °C
- NEC: CL3P

Part No.	ANSI Type	Pairs/Cond.	Color Code	Jacket Color	Insulation Thickness		OD (Nom)	
					Inch	mm	Inch	mm

20 AWG Solid Conductors • Unshielded

FEP Insulation • FEP Jacket								
83932	KX	2c	Yellow, Red	Yellow	.010	.25	.076 x .128	1.93 x 3.25

20 AWG Stranded (7x28) Conductors • Unshielded

FEP Insulation • FEP Jacket								
83930	JX	2c	White, Red	Black	.010	.25	.082 x .149	2.08 x 3.56

20 AWG Stranded (7x28) Conductors • Overall Beldfoil® Shield

FEP Insulation • FEP Jacket								
83955	EX	1 pr	Purple, Red	Purple	.010	.25	.145	3.68
83950	JX	1 pr	White, Red	Black				
83952	KX	1 pr	Yellow, Red	Yellow				
83954	TX	1 pr	Blue, Red	Blue				

16 AWG Solid Conductors • Overall Beldfoil® Shield

FEP Insulation • FEP Jacket								
1114A	EX	1 pr	Purple, Red	Purple	.010	.25	.172	4.37
1115A	JX	1 pr	White, Red	Black				
1116A	KX	1 pr	Yellow, Red	Yellow				
1117A	TX	1 pr	Blue, Red	Blue				

16 AWG Stranded (7 x 24) Conductors • Overall Beldfoil® Shield

FEP Insulation • FEP Jacket								
83951	JX	1 pr	White, Red	Black	.010	.25	.189	4.80
83953	KX	1pr	Yellow, Red	Yellow	.010	.25	.187	4.75

High-Temperature Thermocouple Wire



- UL PLTC
- Sunlight Res
- Oil Res
- +200 °C
- NEC: CL3P

Part No.	ANSI Type	Conductors	Color Code	Jacket Color	Insulation Thickness		OD (Nom)	
					Inch	mm	Inch	mm

20 AWG Solid Conductors • Unshielded

FEP Insulation • FEP Jacket								
83915	E	2	Purple, Red	Brown	.010	.25	.076 x .128	1.93 x 3.25
83900	J	2	White, Red	Brown				
83905	K	2	Yellow, Red	Brown				
83910	T	2	Blue, Red	Brown				

FEP = Fluorinated Ethylene Propylene

UL Instrumentation Cables

600 V Tray Cables – Overview

Construction

Soft annealed bare or tinned copper conductors. PVC insulated with a nylon overcoat, +90 °C PVC Jacket, TFN, TFFN or THHN style singles. Nylon rip cord included in all PVC-Nylon/PVC instrumentation cables.

Application

These cables are suitable for installation in wet or dry locations. Cable jackets are resistant to sunlight, moisture and vapor penetration. The cables can be used in raceways, and (supported by messenger wire), outdoor applications and direct burial applications.

Unshielded

Twisted non-shielded instrument pairs provide a minimal OD allowing greater tray and conduit fill. Non-shielded instrument pairs may be utilized when recommended by the instrument manufacturer and used in a metallic conduit.

Overall Shield

Recommended for use in instrumentation applications where signals are transmitted in excess of 100 millivolts except in areas where high voltage and current sources creates excessive noise interference.

The Beldfoil® shield with drain wire provides 100% coverage for maximum shield effectiveness. Copper tape shield available upon request.

Individually Shielded and Overall Shielded

Individually shielded pairs or triads with an overall shield are recommended for use in instrumentation applications where optimum noise rejection is required. Individual pair/triad shields are fully isolated from each other and contain a separate drain wire for grounding to provide maximum protection from crosstalk and common mode interference. Cables with an overall shield provide additional electrostatic noise protection.

Tray Cable Construction Options

Insulation/Jacket	UL Listed for MC and TC			
	Max. Temp Rating		Flame Tests	Ratings*
	Wet	Dry		
PVC-Nylon/PVC (THHN or THWN) 14 AWG & larger	+75 °C	+90 °C	UL 1685 FT4/IEEE 1202/383 ICEA T-29-520	ICEA S-73-532 ICEA S-61-402
PVC-Nylon/PVC (TFN or TFFN) 16 & 18 AWG	+75 °C	+90 °C	UL 1685 FT4/IEEE 1202/383 ICEA T-29-520	ICEA S-73-532 ICEA S-61-402
XLP/PVC or CPE (XHHW-2) 14 AWG & larger	+90 °C	+90 °C	UL 1685 FT4/IEEE 1202/383 VW-1 rated singles ICEA T-29-520	ICEA S-73-532 ICEA S-66-524
XLP/PVC or CPE (RFH-2) 16 & 18 AWG	+90 °C	+90 °C	UL 1685 FT4/IEEE 1202/383 VW-1 rated singles ICEA T-29-520	ICEA S-73-532 ICEA S-82-552
XLP/Haloorrest® (Thermoplastic) (XHHW-2) 14 AWG & larger (RFH-2) 16 & 18 AWG	+90 °C	+90 °C	UL 1685	TC-LS
XLP/HaloorrestXLink™-1 and -2 (Thermoset) (XHHW-2) 14 AWG & larger (RFH-2) 16 & 18 AWG	+90 °C	+90 °C	UL 1685 ICEA T-29-520 FT4/IEEE 1202/383	TC-ER ICEA S-73-532 T-33-655

CPE = Chlorinated Polyethylene • PVC = Polyvinyl Chloride • XLP = Cross-linked Poly

* Applicable to TC-rated cables only.

UL Instrumentation Cables (continued)
600 V Tray Cables – Overview

Specifications

- UL Subject 1277 TC
- UL 1685 (UL 1581) Vertical Tray Flame
- NEC Type TC Listed, which is approved for cable tray use in Class 1, Division 2 areas, per NEC Articles 340, 318 and 501 and for Class 1 circuits as permitted in Article 725
- PVC-Nylon/PVC constructions are NEC Type NPLF Listed, which is approved for use in Non Power-Limited Fire Protective Signaling circuits, per NEC Article 760
- PVC-Nylon/PVC, XLP/PVC and XLP/CPE constructed cables meet IEEE 1202/IEEE 383-2003/FT4 (70,000 BTU) Flame Test
- XLP/Haloarrest® (thermoplastic) cables are UL 1277 TC-LS rated
- XLP/HaloarrestXLink™-1 and -2 are TC-ER rated

TC-ER Rated Cables

Belden offers all PVC-nylon/PVC, XLP/PVC and XLP/CPE jacketed tray cables with a TC-ER (Exposed Run) rating.

Per NEC Article 336, a TC-ER rated cable may be installed in an industrial establishment between a cable tray and the utilization equipment or device. A TC-ER rated cable must meet the crush and impact requirements of UL Type MC cable. By eliminating the need for metal conduit and/or armor, using a TC-ER rated cable results in savings in both installation and maintenance.

MC Cable Ratings Optional

Customize any 600 V TC instrumentation cable with armor and a full-sized ground. See chart below to specify.

To Specify Conductor, Insulation and Jacket Options:

1234	A	E
Start with Base Part No.	Add or replace letter code for desired Conductor, Insulation, and Jacket	Add for Exposed Run Rating if required

Conductor		Insulation/Jacket
Bare	Tinned	
A	B	PVC-Nylon/PVC
C	D	XLP/PVC
G	H	XLP/TPE
Q	R	XLP/CPE
S	T	XLP/Haloarrest
U	V	XLP/HaloarrestXLink-1
W	X	XLP/HaloarrestXLink-2
Y	Z	XLP/HaloarrestXLink-2, Marine Approved

Code		
Overall Jacket Prefix	Armor Prefix	Base Part No.
1	2	4-digit base number

Overall Jacket

Code	Material
1	PVC
3	CPE
4	TPE
5	HDPE
7	Haloarrest® (Thermoplastic LSZH)

Armor

Code	Material
2	Aluminum Interlock
3	Steel Interlock
4	Aluminum Belclad®
5	Steel Belclad
6	Copper Belclad
8	Continuous Armor

Example: 121049A is part number 1049A with PVC outer jacket and aluminum interlock armor.

CPE = Chlorinated Polyethylene • FEP = Fluorinated Ethylene Propylene • PVC = Polyvinyl Chloride • TPE = Thermoplastic Elastomer • XLP = Cross-Linked Polyethylene

UL Instrumentation Cables

600 V Tray Cables

18 AWG Pairs



- UL TC
- UL Sunlight Res
- Oil Res
- Direct Burial
- NEC: NPLF
- ICEA S-73-532, S-61-402, T-29-520
- FT4
- IEEE 1202/383

Part No.	Pairs	Color Code	Pull Tension (Max)		Bend Radius (Min)		OD (Nom)		Jacket Thickness	
			Lbs	N	Inch	mm	Inch	mm	Inch	mm

18 AWG • Unshielded

Stranded (19 x 30) TC Conductors • PVC/Nylon Insulation • PVC Jacket										
9486	1	E2	50	222	2.75	69.85	.275	6.99	.048	1.22

18 AWG • Overall Beldfoil® Shield

Stranded (19 x 30) TC Conductors • PVC/Nylon Insulation • PVC Jacket										
9341	1	E2	63	280	2.75	69.85	.276	7.01	.048	1.22

18 AWG • Overall Beldfoil® Shield

Stranded (7 x 26) BC Conductors • PVC/Nylon Insulation • PVC Jacket										
1120A	1	E2	59	262	2.80	71.12	.278	7.06	.048	1.22
3088A	1	E1	67	298	2.80	71.12	.278	7.06		
1063A	2	E1	112	498	4.10	104.14	.407	10.34	.053	1.35
1064A	4	E1	202	899	4.70	119.38	.470	11.94		
1065A	8	E1	381	1695	6.00	152.40	.599	15.21	.064	1.63
1066A	12	E1	560	2491	7.20	182.88	.717	18.21		
1067A	16	E1	739	3287	8.00	203.20	.793	20.14	.084	2.13
1068A	24	E1	1098	4884	10.30	261.62	1.017	25.83		
1087A	36	E1	1635	7273	11.70	297.18	1.178	29.97	.084	2.13
1088A	50	E1	2262	10062	14.50	368.30	1.446	36.73		

To Specify Conductor, Insulation and Jacket Options:

1234	A	E
Start with Base Part No. (1000 and 3000 Series cables only)	Add or Modify for Conductor, Insulation, and Jacket. See table at right.	Add for Exposed Run Rating

Bare	Tinned	Insulation/Jacket	Bare	Tinned	Insulation/Jacket
A	B	PVC/PVC	Q	R	XLP/CPE
C	D	XLP/PVC	S	T	XLP/Haloarrest®

BC = Bare Copper • TC = Tinned Copper • CPE = Chlorinated Polyethylene • XLP = Cross-Linked Polyethylene | Belden Color Code Charts can be found at page 345.

UL Instrumentation Cables

600 V Tray Cables

18 AWG Pairs



- UL TC
- UL Sunlight Res
- Oil Res
- Direct Burial
- NEC: NPLF
- ICEA S-73-532, S-61-402, T-29-520
- FT4
- IEEE 1202/383

Part No.	Pairs	Color Code	Pull Tension (Max)		Bend Radius (Min)		OD (Nom)		Jacket Thickness	
			Lbs	N	Inch	mm	Inch	mm	Inch	mm

18 AWG • Individually Beldfoil® Shielded Pairs + Overall Beldfoil® Shield

Stranded (7 x 26) BC Conductors • PVC/Nylon Insulation • PVC Jacket										
1048A	2	E1	140	623	3.80	96.52	.381	9.68	.048	1.22
1049A	4	E1	258	1148	4.90	124.46	.489	12.42	.053	1.35
1050A	8	E1	350	1557	6.60	167.64	.654	16.61	.064	1.63
1051A	12	E1	728	3238	7.90	200.66	.785	19.94		
1052A	16	E1	963	4284	9.00	228.60	.898	22.81		
1053A	24	E1	1434	6379	11.10	281.94	1.115	28.32	.084	2.13
1054A	36	E1	2139	9515	13.00	330.20	1.299	32.99		
1038A	50	E1	2962	13176	15.30	388.62	1.527	38.79		

18 AWG • Overall Beldfoil® Shield • Exposed Run • Green Insulated Ground Wire

Stranded (7 x 26) BC Conductors • PVC/Nylon Insulation • PVC Jacket										
3088AE	1	E1	80	356	3.40	86.36	.340	8.64	.048	1.22

Stranded (7 x 26) BC Conductors • Cross-Linked Poly Insulation • PVC Jacket										
3088CE	1	E1	63	280	2.75	69.85	.276	7.01	.048	1.22

To Specify Conductor, Insulation and Jacket Options:

1234	A	E
Start with Base Part No. (1000 and 3000 Series cables only)	Add or Modify for Conductor, Insulation, and Jacket. See table at right.	Add for Exposed Run Rating

Bare	Tinned	Insulation/Jacket	Bare	Tinned	Insulation/Jacket
A	B	PVC/PVC	Q	R	XLP/CPE
C	D	XLP/PVC	S	T	XLP/Haloarrest®

BC = Bare Copper • CPE = Chlorinated Polyethylene • XLP = Cross-Linked Polyethylene | Belden Color Code Charts can be found at page 345.

UL Instrumentation Cables

600 V Tray Cables

18 AWG Triads



- UL TC
- UL Sunlight Res
- Oil Res
- Direct Burial
- NEC: NPLF
- ICEA S-73-532, S-61-402, T-29-520
- FT4
- IEEE 1202/383

Part No.	Triads	Color Code	Pull Tension (Max)		Bend Radius (Min)		OD (Nom)		Jacket Thickness	
			Lbs	N	Inch	mm	Inch	mm	Inch	mm

18 AWG • Overall Beldfoil® Shield

Stranded (7 x 26) BC Conductors • PVC/Nylon Insulation • PVC Jacket										
1121A	1	E2	81	360	2.90	73.66	.290	7.36	.047	1.22
3089A	1	E1	90	400	2.75	89.85	.282	7.16	.048	1.22

18 AWG • Individually Beldfoil® Shielded Triads + Overall Beldfoil® Shield

Stranded (7 x 26) BC Conductors • PVC/Nylon Insulation • PVC Jacket										
3064A	2	E1	185	823	4.75	120.65	.493	12.52	.048	1.22
1093A	4	E1	347	1545	6.00	152.40	.577	14.66	.063	1.60
1094A	8	E1	672	2989	7.50	190.50	.745	18.92	.084	2.13
1095A	12	E1	997	4435	9.75	247.65	.944	23.98	.084	2.13
1096A	24	E1	1971	8767	13.00	330.20	1.284	32.61	.084	2.13

To Specify Conductor, Insulation and Jacket Options:		
1234	A	E
Start with Base Part No. (1000 and 3000 Series cables only)	Add or Modify for Conductor, Insulation, and Jacket. See table at right.	Add for Exposed Run Rating

Conductor		Insulation/Jacket	Conductor		Insulation/Jacket
Bare	Tinned		Bare	Tinned	
A	B	PVC-Nylon/PVC	S	T	XLP/Haloarrest®
C	D	XLP/PVC	U	V	XLP/HaloarrestXLink™-1
G	H	XLP/TPE	W	X	XLP/HaloarrestXLink-2
Q	R	XLP/CPE	Y	Z	XLP/HaloarrestXLink-2, Marine Approved

BC = Bare Copper • CPE = Chlorinated Polyethylene • PVC = Polyvinyl Chloride • XLP = Cross-Linked Polyethylene | Belden Color Code Charts can be found at page 345.

UL Instrumentation Cables
600 V Tray Cables

16 AWG Pairs



- UL TC
- UL Sunlight Res
- Oil Res
- Direct Burial
- NEC: NPLF
- ICEA S-73-532, S-61-402, T-29-520
- FT4
- IEEE 1202/383

Part No.	Pairs	Color Code	Pull Tension (Max)		Bend Radius (Min)		OD (Nom)		Jacket Thickness	
			Lbs	N	Inch	mm	Inch	mm	Inch	mm

16 AWG • Unshielded

Stranded (19 x 29) TC Conductors • PVC/Nylon Insulation • PVC Jacket										
9487	1	E2	70	311	3.00	76.20	.295	7.49	.048	1.22

16 AWG • Overall Beldfoil® Shield

Stranded (19 x 29) TC Conductors • PVC/Nylon Insulation • PVC Jacket										
9342	1	E2	105	467	3.00	76.20	.296	7.52	.048	1.22

16 AWG • Overall Beldfoil® Shield

Stranded (7 x 24) BC Conductors • PVC/Nylon Insulation • PVC Jacket										
1118A	1	E2	105	467	3.00	76.20	.294	7.47		
3090A	1	E1	105	467	3.00	76.20	.295	7.49		
1069A	2	E1	179	796	4.60	116.84	.456	11.58	.047	1.19
1527A	3	E1	241	1072	4.80	121.92	.482	12.24		
1070A	4	E1	321	1428	5.60	142.24	.560	14.22		
1071A	8	E1	607	2700	6.80	172.72	.676	17.17	.063	1.60
1072A	12	E1	893	3972	8.10	205.74	.812	20.63		
1073A	16	E1	1178	5240	9.30	236.22	.946	24.03		
1074A	24	E1	1749	7780	11.60	294.64	1.158	29.41	.085	2.16
1089A	36	E1	2606	11592	13.20	335.28	1.321	33.55		
1090A	50	E1	3606	16040	15.50	393.70	1.551	39.40		

To Specify Conductor, Insulation and Jacket Options:		
1234	A	E
Start with Base Part No. (1000 and 3000 Series cables only)	Add or Modify for Conductor, Insulation, and Jacket. See table at right.	Add for Exposed Run Rating

Conductor		Insulation/Jacket	Conductor		Insulation/Jacket
Bare	Tinned		Bare	Tinned	
A	B	PVC-Nylon/PVC	S	T	XLP/Haloarrest®
C	D	XLP/PVC	U	V	XLP/HaloarrestXLink™-1
G	H	XLP/TPE	W	X	XLP/HaloarrestXLink-2
Q	R	XLP/CPE	Y	Z	XLP/HaloarrestXLink-2, Marine Approved

TC = Tinned Copper • CPE = Chlorinated Polyethylene • PVC = Polyvinyl Chloride • XLP = Cross-Linked Polyethylene | Belden Color Code Charts can be found at page 345.

UL Instrumentation Cables

600 V Tray Cables

16 AWG Pairs



- UL TC
- UL Sunlight Res
- Oil Res
- Direct Burial
- NEC: NPLF
- ICEA S-73-532, S-61-402, T-29-520
- FT4
- IEEE 1202/383

Part No.	Pairs	Color Code	Pull Tension (Max)		Bend Radius (Min)		OD (Nom)		Jacket Thickness	
			Lbs	N	Inch	mm	Inch	mm	Inch	mm

16 AWG • Individually Beldfoil® Shielded Pairs + Overall Beldfoil® Shield

Stranded (7 x 24) TC Conductors • PVC/Nylon Insulation • PVC Jacket										
1055A	2	E1	223	992	4.16	105.66	.476	12.09		
1037A	3	E1	290	1290	5.00	127.0	.504	12.80	.047	1.19
1039A	4	E1	411	1828	5.80	147.32	.584	14.83		
1040A	6	E1	428	1904	6.80	172.72	.682	17.32	.063	1.60
1041A	8	E1	786	3496	7.40	187.96	.738	18.75		
1042A	12	E1	1161	5164	9.40	238.76	.935	23.75		
1043A	16	E1	1537	6837	10.40	264.16	1.035	26.29		
1044A	20	E1	1912	8505	11.50	292.10	1.146	29.11	.085	2.16
1045A	24	E1	2287	10173	12.70	322.58	1.272	32.31		
1046A	36	E1	3413	15182	14.50	368.30	1.454	36.93		
1047A	50	E1	4726	21022	17.80	452.12	1.781	45.24	.120	3.05

16 AWG • Overall Beldfoil® Shield • Exposed Run • Green Insulated Ground Wire

Stranded (7 x 24) BC Conductors • PVC/Nylon Insulation • PVC Jacket										
3090AE	1	E1	130	578	3.90	99.06	.390	9.91	.048	1.22
Stranded (7 x 24) BC Conductors • Cross-Linked Poly Insulation • PVC Jacket										
3090CE	1	E1	130	578	3.90	99.06	.390	9.91	.048	1.22

To Specify Conductor, Insulation and Jacket Options:		
1234	A	E
Start with Base Part No. (1000 and 3000 Series cables only)	Add or Modify for Conductor, Insulation, and Jacket. See table at right.	Add for Exposed Run Rating

Conductor		Insulation/Jacket	Conductor		Insulation/Jacket
Bare	Tinned		Bare	Tinned	
A	B	PVC-Nylon/PVC	S	T	XLP/Haloarrest®
C	D	XLP/PVC	U	V	XLP/HaloarrestXLink™-1
G	H	XLP/TPE	W	X	XLP/HaloarrestXLink-2
Q	R	XLP/CPE	Y	Z	XLP/HaloarrestXLink-2, Marine Approved

BC = Bare Copper • TC = Tinned Copper • CPE = Chlorinated Polyethylene • PVC = Polyvinyl Chloride • TPE = Thermoplastic Elastomer • XLP = Cross-Linked Polyethylene
 Belden Color Code Charts can be found at page 345.

UL Instrumentation Cables

600 V Tray Cables

16 AWG Triads



- UL TC
- UL Sunlight Res
- Oil Res
- Direct Burial
- NEC: NPLF
- ICEA S-73-532, S-61-402, T-29-520
- FT4
- IEEE 1202/383

Part No.	Triads	Color Code	Pull Tension (Max)		Bend Radius (Min)		OD (Nom)		Jacket Thickness	
			Lbs	N	Inch	mm	Inch	mm	Inch	mm

16 AWG • Overall Beldfoil® Shield

Stranded (7 x 24) BC Conductors • PVC/Nylon Insulation • PVC Jacket										
1119A	1	E2	129	574	3.10	78.74	.310	7.87	.047	1.19
3091A	1	E1								

16 AWG • Individually Beldfoil® Shielded Triads + Overall Beldfoil® Shield

Stranded (7 x 24) BC Conductors • PVC/Nylon Insulation • PVC Jacket										
1097A	4	E1	554	2464	6.40	162.56	.640	16.26	.063	1.60
1098A	8	E1	1072	4768	8.70	220.98	.872	22.15	.085	2.16
1099A	12	E1	1590	7073	10.50	266.70	1.047	26.59	.085	2.16
3118A	16	E1	1771	7878	12.25	311.15	1.234	31.34	.084	2.13
1100A	24	E1	3144	13985	14.30	363.22	1.434	36.42	.085	2.16
3130A	36	E1	3600	16014	18.00	457.20	1.773	45.03	.110	2.79

To Specify Conductor, Insulation and Jacket Options:		
1234	A	E
Start with Base Part No. (1000 and 3000 Series cables only)	Add or Modify for Conductor, Insulation, and Jacket. See table at right.	Add for Exposed Run Rating

Conductor		Insulation/Jacket	Conductor		Insulation/Jacket
Bare	Tinned		Bare	Tinned	
A	B	PVC-Nylon/PVC	S	T	XLP/Haloarrest®
C	D	XLP/PVC	U	V	XLP/HaloarrestXLink™-1
G	H	XLP/TPE	W	X	XLP/HaloarrestXLink-2
Q	R	XLP/CPE	Y	Z	XLP/HaloarrestXLink-2, Marine Approved

BC = Bare Copper • CPE = Chlorinated Polyethylene • PVC = Polyvinyl Chloride • TPE = Thermoplastic Elastomer • XLP = Cross-Linked Polyethylene | Belden Color Code Charts can be found at page 345.

UL Instrumentation Cables

600 V Tray Cables

14 AWG Pairs



- UL TC
- UL Sunlight Res
- Oil Res
- Direct Burial
- NEC: NPLF
- ICEA S-73-532, S-61-402, T-29-520
- FT4
- IEEE 1202/383

Part No.	Pairs	Color Code	Pull Tension (Max)		Bend Radius (Min)		OD (Nom)		Jacket Thickness	
			Lbs	N	Inch	mm	Inch	mm	Inch	mm

14 AWG • Unshielded

Stranded (42 x 30) TC Conductors • PVC/Nylon Insulation • PVC Jacket										
9488	1	E2	107	476	3.75	95.25	.359	9.12	.048	1.22

14 AWG • Overall Beldfoil® Shield

Stranded (42 x 30) TC Conductors • PVC/Nylon Insulation • PVC Jacket										
9343	1	E2	160	712	3.75	95.25	3.58	9.09	.048	1.22

14 AWG • Overall Beldfoil® Shield

Stranded (7 x 22) BC Conductors • PVC/Nylon Insulation • PVC Jacket										
3080A	1	E2	160	712	3.50	88.90	.342	8.69	.048	1.22

To Specify Conductor, Insulation and Jacket Options:		
1234	A	E
Start with Base Part No. (1000 and 3000 Series cables only)	Add or Modify for Conductor, Insulation, and Jacket. See table at right.	Add for Exposed Run Rating

Conductor		Insulation/Jacket	Conductor		Insulation/Jacket
Bare	Tinned		Bare	Tinned	
A	B	PVC-Nylon/PVC	S	T	XLP/Haloarrest®
C	D	XLP/PVC	U	V	XLP/HaloarrestXLink™-1
G	H	XLP/TPE	W	X	XLP/HaloarrestXLink-2
Q	R	XLP/CPE	Y	Z	XLP/HaloarrestXLink-2, Marine Approved

BC = Bare Copper • TC = Tinned Copper • CPE = Chlorinated Polyethylene • PVC = Polyvinyl Chloride • TPE = Thermoplastic Elastomer • XLP = Cross-Linked Polyethylene
 Belden Color Code Charts can be found at page 345.

UL Instrumentation Cables

600 V Tray Cables

14 AWG Triads



- UL TC
- UL Sunlight Res
- Oil Res
- Direct Burial
- NEC: NPLF
- ICEA S-73-532, S-61-402, T-29-520
- FT4
- IEEE 1202/383

Part No.	Triads	Color Code	Pull Tension (Max)		Bend Radius (Min)		OD (Nom)		Jacket Thickness	
			Lbs	N	Inch	mm	Inch	mm	Inch	mm
14 AWG • Overall Beldfoil® Shield										
Stranded (7 x 22) BC Conductors • PVC/Nylon Insulation • PVC Jacket										
3081A	1	E1	200	890	3.50	88.90	.361	9.17	.048	1.22

12 AWG Pairs



- UL TC
- UL Sunlight Res
- Oil Res
- Direct Burial
- NEC: NPLF
- ICEA S-73-532, S-61-402, T-29-520
- FT4
- IEEE 1202/383

Part No.	Pairs	Color Code	Pull Tension (Max)		Bend Radius (Min)		OD (Nom)		Jacket Thickness	
			Lbs	N	Inch	mm	Inch	mm	Inch	mm
12 AWG • Unshielded										
Stranded (37 x 27) TC Conductors • PVC/Nylon Insulation • PVC Jacket										
9489	1	E2	179	796	3.75	95.25	.380	9.65	0.45	1.14

12 AWG • Overall Beldfoil® Shield

Stranded (37 x 27) TC Conductors • PVC/Nylon Insulation • PVC Jacket										
9344	1	E2	253	1125	3.75	95.25	.384	9.75	.045	1.14

12 AWG • Overall Beldfoil® Shield

Stranded (7 x 20) BC Conductors • PVC/Nylon Insulation • PVC Jacket										
3103A	1	E1	253	1125	3.80	96.52	.380	9.65	.048	1.22

12 AWG Triads



- UL TC
- UL Sunlight Res
- Oil Res
- Direct Burial
- NEC: NPLF
- ICEA S-73-532, S-61-402, T-29-520
- FT4
- IEEE 1202/383

Part No.	Pairs	Color Code	Pull Tension (Max)		Bend Radius (Min)		OD (Nom)		Jacket Thickness	
			Lbs	N	Inch	mm	Inch	mm	Inch	mm
12 AWG • Overall Beldfoil® Shield										
Stranded (7 x 20) BC Conductors • PVC/Nylon Insulation • PVC Jacket										
3104A	1	E1	315	1401	4.00	101.60	.401	10.19	.048	1.22

To Specify Conductor, Insulation and Jacket Options:		
1234	A	E
Start with Base Part No. (1000 and 3000 Series cables only)	Add or Modify for Conductor, Insulation, and Jacket. See table at right.	Add for Exposed Run Rating

Conductor		Insulation/Jacket	Conductor		Insulation/Jacket
Bare	Tinned		Bare	Tinned	
A	B	PVC-Nylon/PVC	S	T	XLP/Haloarrest®
C	D	XLP/PVC	U	V	XLP/HaloarrestXLink™-1
G	H	XLP/TPE	W	X	XLP/HaloarrestXLink-2
Q	R	XLP/CPE	Y	Z	XLP/HaloarrestXLink-2, Marine Approved

BC = Bare Copper • TC = Tinned Copper • CPE = Chlorinated Polyethylene • PVC = Polyvinyl Chloride • TPE = Thermoplastic Elastomer • XLP = Cross-Linked Polyethylene
 Belden Color Code Charts can be found at page 344.

CSA Instrumentation and Thermocouple Tray Cables

300 V TC/CIC

Pairs • Unshielded



- +90 °C Dry, +75 °C Wet (PVC)
- +90 °C Dry/Wet (XLP)
- Sunlight Res
- Direct Burial
- CSA C22.2 No. 239 CIC
- CSA C22.2 No. 230 Type TC
- CSA FT4 70,000 BTU Flame Test
- CEC Part 1, Suitable for Use in Hazardous Locations: Class 1, Zone 2 and Class 2, Division 2

Pairs	Part No.				
	7-Strand Copper	Solid EX Chromel/Constantan	Solid JX Iron/Constantan	Solid KX Chromel/Alumel	Solid TX Copper/Constantan
20 AWG • PVC Insulation • PVC Jacket					
1	22000	21100	21114	21128	21142
2	22001	21101	21115	21129	21143
4	22002	21102	21116	21130	21144
6	22003	21103	21117	21131	21145
8	22004	21104	21118	21132	21146
10	22005	21105	21119	21133	21147
12	22006	21106	21120	21134	21148
16	22007	21107	21121	21135	21149
20	22008	21108	21122	21136	21150
24	22009	21109	21123	21137	21151
30	22010	21110	21124	21138	21152
36	22011	21111	21125	21139	21153
40	22012	21112	21126	21140	21154
50	22013	21113	21127	21141	21155
18 AWG • PVC Insulation • PVC Jacket					
1	22027	21156	21170	21184	21198
2	22028	21157	21171	21185	21199
4	22029	21158	21172	21186	21200
6	22030	21159	21173	21187	21201
8	22031	21160	21174	21188	21202
10	22032	21161	21175	21189	21203
12	22033	21162	21176	21190	21204
16	22034	21163	21177	21191	21205
20	22035	21164	21178	21192	21206
24	22036	21165	21179	21193	21207
30	22037	21166	21180	21194	21208
36	22038	21167	21181	21195	21209
40	22039	21168	21182	21196	21210
50	22040	21169	21183	21197	21211
16 AWG • PVC Insulation • PVC Jacket					
1	22054	21212	21226	21240	21254
2	22055	21213	21227	21241	21255
4	22056	21214	21228	21242	21256
6	22057	21215	21229	21243	21257
8	22058	21216	21230	21244	21258
10	22059	21217	21231	21245	21259
12	22060	21218	21232	21246	21260
16	22061	21219	21233	21247	21261
20	22062	21220	21234	21248	21262
24	22063	21221	21235	21249	21263
30	22064	21222	21236	21250	21264
36	22065	21223	21237	21251	21265
40	22066	21224	21238	21252	21266
50	22067	21225	21239	21253	21267

PVC = Polyvinyl Chloride

CSA Instrumentation and Thermocouple Tray Cables

300 V TC/CIC

Triads • Unshielded



- +90 °C Dry, +75 °C Wet (PVC)
- +90 °C Dry/Wet (XLP)
- Sunlight Res
- Direct Burial
- CSA C22.2 No. 239 CIC
- CSA C22.2 No. 230 Type TC
- CSA FT4 70,000 BTU Flame Test
- CEC Part 1, Suitable for Use in Hazardous Locations: Class 1, Zone 2 and Class 2, Division 2

Triads	Part No.		
	20 AWG	18 AWG	16 AWG
Copper Conductors • PVC Insulation (Black, White, Red) • PVC Jacket			
1	22014	22041	22068
2	22015	22042	22069
4	22016	22043	22070
6	22017	22044	22071
8	22018	22045	22072
10	22019	22046	22073
12	22020	22047	22074
16	22021	22048	22075
20	22022	22049	22076
24	22023	22050	22077
30	22024	22051	22078
36	22025	22052	22079

To Create a Part Number

To the base part number, add a letter suffix for conductor, insulation, and, jacket, and a numeric suffix for shielding, as shown below.

Suffix	Conductor	Insulation	Jacket	Suffix	Shielding (includes Drain wire)
A	Bare Copper or Thermocouple Alloy	PVC	PVC	none	No Shielding
B	Tinned Copper	PVC	PVC	1	Overall Foil + Drain Wire
C	Bare Copper or Thermocouple Alloy	XLP	PVC	2	Individual Pairs/Triads + Overall Foil
D	Tinned Copper	XLP	PVC		

Sample Part Number: 22001B2 = 300 V, 2-pair 20 AWG tinned copper conductor cable with PVC insulation, PVC jacket, with individual and overall foil shields plus drain wire.

Thermocouple Color Codes

ANSI Type	Jacket	Insulation	
		Positive (+)	Negative (-)
EX	Purple	Purple	Red
JX	Black	White	Red
KX	Yellow	Yellow	Red
TX	Blue	Blue	Red

PVC = Polyvinyl Chloride • XLP = Cross-Linked Polyethylene

CSA Instrumentation Cables

300 V CIC

Contact Belden Customer Service for other options:

- 150 V
- XLP insulation (add D suffix to part number)
- Thermocouple alloy conductors
- Overall foil shield only
- Other pair and triad counts

Pairs • Individually Shielded Pairs + Overall Beldfoil® Shield



- -40 °C to +105 °C Dry
- -40 °C to +75 °C Wet
- -25 °C Cold Impact

- CSA C22.2 No. 239, Type CIC
- FT4 Flame Test

Part No.	Pairs	Color Code	OD (Nom)		Jacket Thickness	
			Inch	mm	Inch	mm

Stranded TC Conductors • PVC Insulation • Individually Shielded Pairs + Overall Beldfoil® Shield • Polyester Isolation Tape • PVC Jacket

20 AWG • 7 x 28

22671	1	E1	.260	6.60		
22638	2	E1	.400	10.16		
22639	4	E1	.460	11.68	.045	1.14
22640	6	E1	.570	14.48		
22641	8	E1	.610	15.49		
22676	12	E1	.730	18.54	.060	1.52
22643	16	E1	.810	20.57		
22647	24	E1	1.040	26.42	.080	2.03
22670	36	E1	1.190	30.23		

18 AWG • 7 x 26

22645	1	E1	.300	7.62		
22633	2	E1	.480	12.19	.045	1.14
22648	4	E1	.580	14.73		
22634	6	E1	.670	17.02		
22635	8	E1	.730	18.54	.060	1.52
22636	12	E1	.920	23.37		
22654	16	E1	1.020	25.91	.080	2.03
22637	24	E1	1.260	32.00		

16 AWG • 7 x 24

22646	1	E1	.320	8.13		
22628	2	E1	.520	13.21	.045	1.14
22629	4	E1	.628	15.95		
22630	6	E1	.740	18.80	.060	1.52
22631	8	E1	.800	20.32		
22632	12	E1	1.010	25.65		
22685	16	E1	1.120	28.45	.080	2.03
22686	24	E1	1.380	35.05		

TC = Tinned Copper • PVC = Polyvinyl Chloride | Belden Color Code Charts can be found at page 345.

CSA Instrumentation Cables
300 V CIC

**Triads • Individually Shielded Triads
+ Overall Beldfoil® Shield**



- -40 °C to +105 °C Dry
- -40 °C to +75 °C Wet
- -25 °C Cold Impact

- CSA C22.2 No . 239, Type CIC
- FT4 Flame Test

Part No.	Triads	Color Code	OD (Nom)		Jacket Thickness	
			Inch	mm	Inch	mm

Stranded TC Conductors • PVC Insulation • Individually Shielded Triads + Overall Beldfoil® Shield • Polyester Isolation Tape • Black PVC Jacket

20 AWG • 7 x 28

22660	1	E1	.270	6.86		
22662	2	E1	.420	10.67	.045	1.14
22663	4	E1	.490	12.45		
22672	8	E1	.650	16.51	.060	1.52
22673	16	E1	.910	23.11		
22674	24	E1	1.110	28.19	.080	2.03

18 AWG • 7 x 26

22677	1	E1	.303	7.70		
22678	2	E1	.480	12.19	.045	1.14
22679	4	E1	.620	15.75		
22680	8	E1	.710	18.03	.060	1.52
22681	16	E1	.770	19.56		
22682	24	E1	.980	24.89		
22683	16	E1	1.090	27.69	.080	2.03
22684	24	E1	1.340	34.04		

16 AWG • 7 x 24

22603	1	E1	.329	8.36		
22687	2	E1	.580	14.73	.045	1.14
22675	4	E1	.670	17.02		
22688	6	E1	.780	19.81	.060	1.52
22689	8	E1	.940	23.88	.080	2.03

TC = Tinned Copper • PVC = Polyvinyl Chloride | Belden Color Code Charts can be found at page 345.

CSA Instrumentation Cables

300 V ACIC Armored Cables

Pairs • Armored • Individually Beldfoil® Shielded Pairs + Overall Beldfoil® Shield



- -40 °C to +105 °C Dry
- -40 °C to +75 °C Wet
- -25 °C Cold Impact

- CSA C22.2 No. 239, Type ACIC
- CSA C22.2 No. 174, HLABCD
- CSA C22.2 No. 0.3 Clause 4.31 Low Acid Gas (Jacket Only)
- FT4 Flame Test

Part No.		Pairs	Color Code	Inner Jacket OD		Outer Jacket OD		Insulation Thickness	
Aluminum	Steel			Inch	mm	Inch	mm	Inch	mm

Stranded TC Conductors • PVC Insulation • Individually Beldfoil® Shielded Pairs + Overall Beldfoil® Shield • Polyester Isolation Tape • PVC Inner Jacket • Armor • Chrome PVC Outer Jacket

20 AWG • 7 x 28

23543	26530	1	E1	.26	6.6	.56	14.2		
23534	26531	2	E1	.40	10.2	.70	17.8		
23514	26532	4	E1	.46	11.7	.76	19.3		
23513	26533	6	E1	.57	14.5	.88	22.4		
23503	26534	8	E1	.63	16.0	.92	23.4		
23521	26535	12	E1	.75	19.1	1.06	26.9	.020	.51
23532	26536	16	E1	.79	20.1	1.16	29.5		
23506	26537	24	E1	1.05	26.7	1.42	36.1		
23544	26538	36	E1	1.14	29.0	1.57	39.9		
23575	26546	50	E1	1.37	34.8	1.75	44.5		

18 AWG • 7 x 26

23533	26514	1	E1	.30	7.6	.60	15.2		
23511	26515	2	E1	.48	12.2	.78	19.8		
23530	26516	4	E1	.58	14.7	.88	22.4		
23528	26517	6	E1	.67	17.0	.98	24.9		
23531	26518	8	E1	.73	18.5	1.03	26.2	.025	.64
23524	26519	12	E1	.90	22.9	1.28	32.5		
23519	26520	16	E1	.99	25.1	1.37	34.8		
23542	26521	24	E1	1.24	31.5	1.63	41.4		
23554	26555	36	E1	1.41	35.8	1.80	45.7		

16 AWG • 7 x 24

23501	26500	1	E1	.33	8.4	.62	15.8		
23527	26501	2	E1	.52	13.2	.81	20.6		
23509	26503	4	E1	.63	16.0	.93	23.6		
23500	26504	6	E1	.73	18.5	1.03	26.2		
23510	26505	8	E1	.79	20.1	1.16	29.5	.025	.64
23525	26506	12	E1	1.00	25.4	1.37	34.8		
23539	26507	16	E1	1.12	28.2	1.48	37.6		
23538	26508	24	E1	1.36	34.5	1.75	44.5		
23568	26551	36	E1	1.60	40.6	1.97	50.0		

TC = Tinned Copper • PVC = Polyvinyl Chloride | Belden Color Code Charts can be found at page 345.

CSA Instrumentation Cables
300 V ACIC Armored Cables

Triads • Armored • Individually Beldfoil® Shielded Triads + Overall Beldfoil® Shield



- -40 °C to +105 °C Dry
- -40 °C to +75 °C Wet
- -25 °C Cold Impact

- CSA C22.2 No. 239, Type ACIC
- CSA C22.2 No. 174, HLABCD
- CSA C22.2 No. 0.3 Clause 4.31 Low Acid Gas (Jacket Only)
- FT4 Flame Test

Part No.		Triads	Color Code	Inner Jacket OD		Outer Jacket OD		Insulation Thickness	
Aluminum	Steel			Inch	mm	Inch	mm	Inch	mm

Stranded TC Conductors • PVC Insulation • Individually Beldfoil® Shielded Triads + Overall Beldfoil® Shield • Polyester Isolation Tape • PVC Inner Jacket • Armor • Chrome PVC Outer Jacket

20 AWG • 7 x 28

23545	26539	1	E1	.27	6.9	.57	14.5		
23546	26540	2	E1	.43	10.9	.73	18.5		
23547	26541	4	E1	.50	12.7	.80	20.3		
23548	26542	8	E1	.69	17.5	1.00	25.4	.020	.51
23571	26553	12	E1	.82	20.8	1.24	31.5		
23549	26543	16	E1	.91	23.1	1.28	32.5		
23550	26544	24	E1	1.11	28.2	1.48	37.6		

18 AWG • 7 x 26

23505	26522	1	E1	.33	8.4	.61	15.5		
23516	26523	2	E1	.51	13.0	.81	20.6		
23515	26524	4	E1	.62	15.7	.93	23.6		
23508	26525	6	E1	.75	19.1	1.11	28.2	.025	.64
23523	26526	8	E1	.81	20.6	1.18	30.0		
23512	26527	12	E1	1.03	26.2	1.40	35.6		
23537	26528	16	E1	1.13	28.7	1.50	38.1		
23536	26529	24	E1	1.37	34.8	1.80	45.7		

16 AWG • 7 x 24

23507	26502	1	E1	.35	8.9	.63	16.0		
23522	26509	2	E1	.58	14.7	.90	22.9		
23520	26510	4	E1	.68	17.3	.95	24.1		
23529	26511	6	E1	.78	19.8	1.19	30.2	.025	.64
23526	26512	8	E1	.93	23.6	1.30	33.0		
23541	26513	12	E1	1.13	28.7	1.50	38.1		
23567	26545	16	E1	1.25	31.8	1.64	41.7		
23578	26547	24	E1	1.58	40.1	1.95	49.5		

TC = Tinned Copper • PVC = Polyvinyl Chloride | Belden Color Code Charts can be found at page 345.

CSA Instrumentation Cables
600 V ACIC Armored Cables

Pairs • Armored • Individually Beldfoil® Shielded Pairs + Overall Beldfoil® Shield



- -40 °C to +105 °C Dry
- -40 °C to +75 °C Wet
- -25 °C Cold Impact

- CSA C22.2 No. 239, Type ACIC
- CSA C22.2 No. 174, HLABCD
- CSA C22.2 No. 0.3 Clause 4.31 Low Acid Gas (Jacket Only)
- FT4 Flame Test

Part No.		Pairs	Color Code	Inner Jacket OD		Outer Jacket OD		Insulation Thickness	
Aluminum	Steel			Inch	mm	Inch	mm	Inch	mm

Stranded TC Conductors • PVC Insulation • Individually Beldfoil® Shielded Pairs + Overall Beldfoil® Shield • Polyester Isolation Tape • PVC Inner Jacket • Armor • Chrome PVC Outer Jacket

18 AWG • 7 x 26

24511	25506	1	E1	.32	8.13	.61	15.49	.030	.76
24512	25514	2	E1	.51	12.95	.82	20.83		
24513	25503	4	E1	.63	16.00	.93	23.62		
24514	25505	8	E1	.79	20.27	1.15	29.21		
24515	25501	12	E1	1.00	25.40	1.36	34.54		
24520	25517	24	E1	1.36	34.54	1.75	44.45		

16 AWG • 7 x 24

24500	25504	1	E1	.34	8.64	.64	16.26	.030	.76
24505	25510	2	E1	.59	14.99	.89	22.61		
24502	25511	4	E1	.68	17.27	.98	24.89		
24506	25512	6	E1	.79	20.07	1.16	29.46		
24503	25513	8	E1	.90	22.86	1.27	32.26		
24504	25518	12	E1	1.09	27.69	1.46	37.08		
24510	25519	24	E1	1.49	37.85	1.88	47.75		

Triads • Armored • Individually Beldfoil® Shielded Triads + Overall Beldfoil® Shield



- -40 °C to +105 °C Dry
- -40 °C to +75 °C Wet
- -25 °C Cold Impact

- CSA C22.2 No. 239, Type ACIC
- CSA C22.2 No. 174, HLABCD
- CSA C22.2 No. 0.3 Clause 4.31 Low Acid Gas (Jacket Only)
- FT4 Flame Test

Part No.		Triads	Color Code	Inner Jacket OD		Outer Jacket OD		Insulation Thickness	
Aluminum	Steel			Inch	mm	Inch	mm	Inch	mm

Stranded TC Conductors • PVC Insulation • Individually Beldfoil® Shielded Triads + Overall Beldfoil® Shield • Polyester Isolation Tape • PVC Inner Jacket • Armor • Chrome PVC Outer Jacket

18 AWG • 7 x 26

24516	25500	1	E1	.34	8.64	.63	16.00	.030	.76
24517	25522	2	E1	.58	14.73	.89	22.61		
24518	25520	4	E1	.66	16.76	.99	25.15		
24519	25523	8	E1	.88	22.35	1.29	32.77		

16 AWG • 7 x 24

24501	25502	1	E1	.36	9.14	.66	16.76	.030	.76
24507	25507	2	E1	.62	15.75	.94	23.88		
24508	25509	4	E1	.72	18.29	1.05	26.67		
24509	25508	8	E1	.96	24.38	1.33	33.78		

TC = Tinned Copper • PVC = Polyvinyl Chloride | Belden Color Code Charts can be found at page 345.



Power & Control Variable Frequency Drive (VFD) Cables

Section Table of Contents

Power & Control	Page
Variable Frequency Drive (VFD) Cables	
Overview	140–141
Cross Reference Guide	142–144
Classic and Symmetrical VFD Cables	145–146
Low Smoke Zero Halogen VFD Cables	147–148
Armored VFD Cables	149
CSA VFD Cables	150

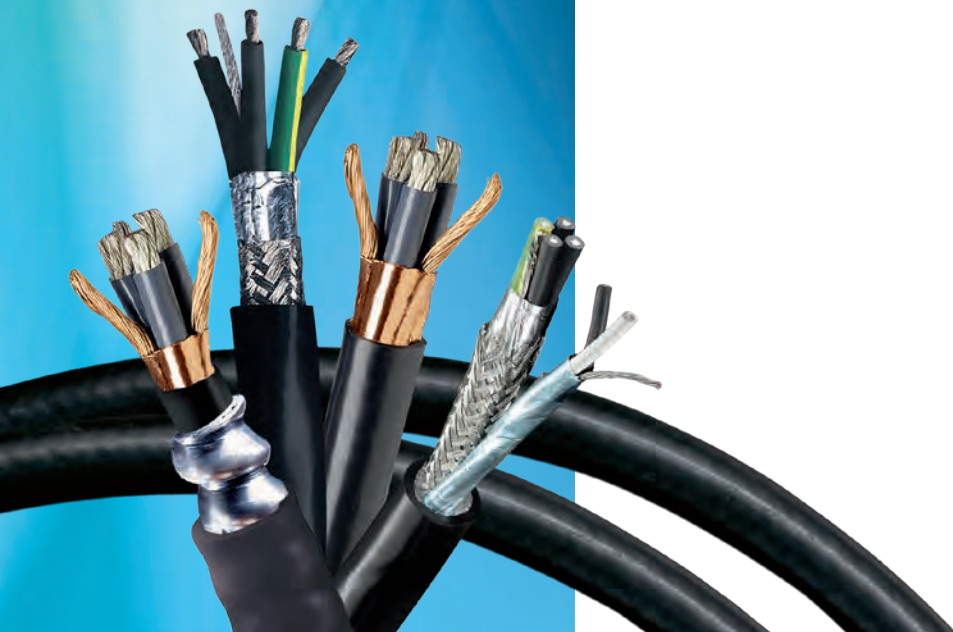

Variable Frequency Drive (VFD) Cables



Variable frequency AC motor drive output cables are subject to harsh operating environments characterized by high voltage spikes, high noise levels and adverse environmental conditions. Typical cabling solutions for this application have been unshielded tray cables, single-conductor lead wire installed in conduit or continuously-welded armored cable. These solutions suffer from complex, costly installation and potential reliability problems. Belden Variable Frequency Drive (VFD) Cables were designed and engineered to overcome these challenges.

Product Features

Jacket Options

- Industrial-grade PVC (Sunlight and oil-resistant)
- Haloarrest Jackets – Halogen-free LSZH

Insulation

- XLP – lower capacitance resulting in reduced voltage spikes and corona discharge

Shielding

- 100% coverage foil shield along with an 80% braid shield or Dual 5 mm Copper Tape

Grounding

- Full-sized insulated ground allows lower resistance path to ground

AWG Sizes

- From 16 to 4/0 AWG

Benefits

Thicker, Industrial-grade XLPE Insulation

- Provides more stable electrical performance than PVC
- Lower capacitance resulting in
 - Longer cable runs
 - Reduced peak motor terminal voltage for extended motor life
 - Reduced likelihood of corona discharge
 - Reduced magnitude of standing waves
 - Increased efficiency of power transfer

High-strand Tinned Copper Circuit Conductors

- More flexible for ease of installation
- Better vibration resistance
- Numbered for ease of identification

Industrial-grade PVC or Haloarrest Low Smoke Zero Halogen Jackets

- Sunlight Resistant
- Oil Resistant (PVC only)

Applications

VFD drives are utilized in all industrial vertical markets and are used to:

- Run process equipment and machinery
- Power pumps to move fluids
- Drive fans to move air
- Run conveyors to transport a wide range of materials

Variable Frequency Drive (VFD) Cables

Overview

Belden VFD Cables are Designed to Deliver Top Performance in Any Type of Environment

All Cables

- Thicker, industrial-grade XLP insulations provide low capacitance for extended motor life, reduced likelihood of corona discharge, reduced magnitude of standing waves, increased efficiency of power transfer
- Robust ground and shielding system to minimize radiated and conducted noise that can disrupt plant control and instrumentation systems
- Reliably carry power from AC drive systems to AC motors
- Effectively handle the overall high power levels of pulse-width modulated (PWM) signals
- Reliably handle high voltage spikes – eliminating potential damage to the cable, motors, bearings, drives and related equipment – potentially extending their life
- Industrial-grade PVC jackets provide sunlight and oil-resistance; Haloarrest® jackets are halogen-free and provide sunlight-resistance in LSZH versions
- HaloarrestXLink™ jackets are thermoset and low smoke zero halogen for exposure in harsh environments
- Resistant to adverse or harsh environments
- ER rating allows for the elimination of conduit for easier and less expensive installations
- Effectively eliminate downtime due to cable failure

Classic Foil/Braid Designs

- High-strand conductors ease installation; enable better vibration resistance
- Full-sized insulated ground allows lower resistance path to ground
- Tinned copper conductors to prevent against corrosion
- Low capacitance and low impedance of the cables closely matches the drive and electrical values
- Round configuration for reliable sealing

Classic Symmetrical Designs

- Available with high-strand conductors in large AWG sizes
- Design features a copper tape shield with segmented ground
- Smaller OD than the Classic Designs with Foil/Braid

Classic Designs with Signal Pair

- Overall jackets provide more protection for the integrated signal pair
- Easier, lower cost installation than pulling the signal pair separately

Termination Guide

See our Unarmored VFD Cable Termination Guide (Lit No. VFDCDG) for a step-by-step look at best practices for installing and terminating unarmored VFD cables, available on-line at www.belden.com.

Applicable for Use With:

- Rockwell Automation AC drives
- ABB/Baldor
- Danfoss
- Eaton/Cutler-Hammer
- Emerson
- General Electric
- Hitachi
- Magnetek
- Mitsubishi Electric Automation
- OMRON
- Robicon
- Schneider Electric
- Siemens
- Toshiba
- Vacon (TB Wood's)
- WEG
- Yaskawa

Belden VFD Cables versus Tray Cables or Single Conductor Products

- Superior radiated and conducted noise protection with robust shield and ground design
- XLP insulation provides lower capacitance resulting in reduced voltage spikes and corona discharge
- Extended motor life
- Longer cable runs

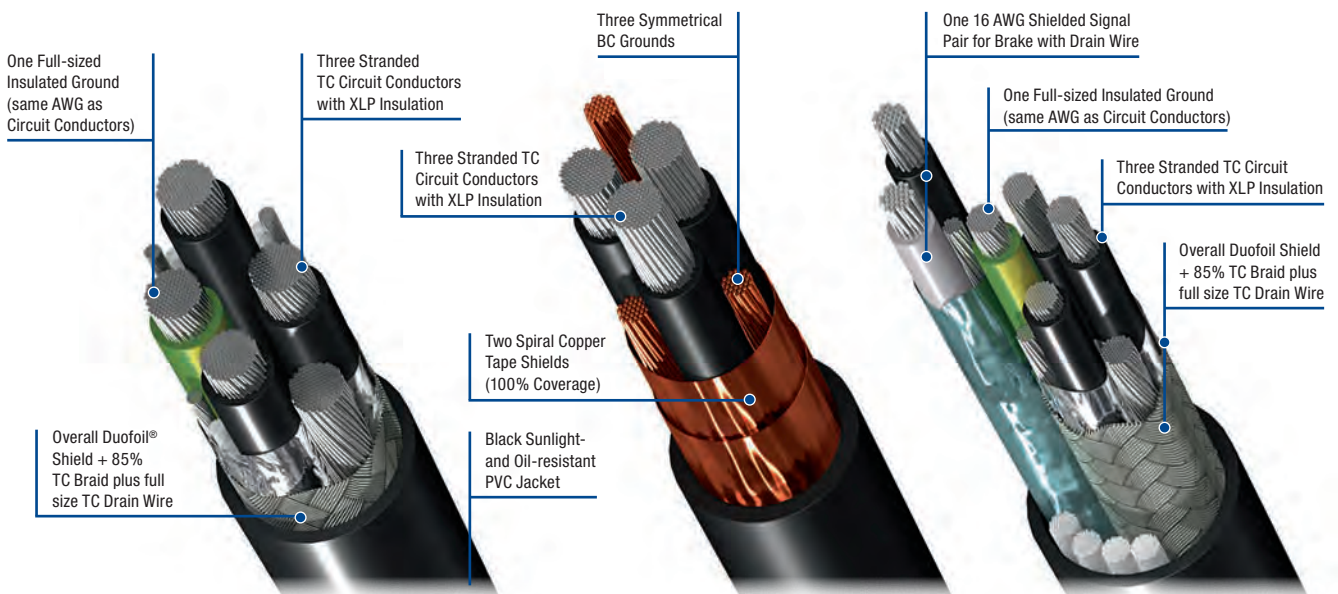

VFD Cross Reference Guide

Voltage	HP	kW	Sizes	Classic VFD Part No.	Classic with Signal Pair Part No.	2 kV VFD Part No.	CSA VFD Part No.	LSZH VFD Part No.	Thermoset LSZH VFD, Marine Approvals Part No.
230 V 3Ø	.25 to 3	0.75 to 2.2	16	29500	29510	—	—	29500T	29500X
	5	3.7	14	29501	29511	29536	29550C	29501T	29501X
			12	29502	29512	29537	29551C	29502T	29502X
	7.5	5.6	12	29502	29512	29537	29551C	29502T	29502X
	10	7.5	10	29503	29513	29538	29552C	29503T	29503X
	15	11.2	8	29504	—	29539	29553C	29504T	29504X
	20	14.9	6	29505	—	29540	29554C	29505T	29505X
	25	18.6	4	29506	—	29541	29555C	29506T	29506X
	40	29.8	2	29507	—	29542	29556C	29507T	29507X
			1	29528	—	29543	29557C	29528T	29528X
	50	37.3	1/0	29529	—	29544	29558C	29529T	29529X
			2/0	29530	—	29545	29559C	29530T	29530X
	60	44.7	3/0	29531	—	29546	29560C	29531T	29531X
			4/0	29532	—	29547	29561C	29532T	29532X
	75	55.9	250 MCM	—	—	29533	29533	—	—
	100	74.6	350 MCM	—	—	29534	29534	—	—
125	93.2	500 MCM	—	—	29535	29535	—	—	
460 V 3Ø	10	7.5	16	29500	29510	—	—	29500T	29500X
			14	29501	29511	29536	29550C	29501T	29501X
			12	29502	29512	29537	29551C	29502T	29502X
	15	11.2	12	29502	29512	29537	29551C	29502T	29502X
			10	29503	29513	29538	29552C	29503T	29503X
	20	14.9	10	29503	29513	29538	29552C	29503T	29503X
	30	22.4	8	29504	—	29539	29553C	29504T	29504X
	40	29.8	6	29505	—	29540	29554C	29505T	29505X
	50	37.3	4	29506	—	29541	29555C	29506T	29506X
	75	55.9	2	29507	—	29542	29556C	29507T	29507X
			1	29528	—	29543	29557C	29528T	29528X
	100	74.6	1/0	29529	—	29544	29558C	29529T	29529X
	125	93.2	2/0	29530	—	29545	29559C	29530T	29530X
			3/0	29531	—	29546	29560C	29531T	29531X
	150	111.9	4/0	29532	—	29547	29561C	29532T	29532X
			250 MCM	—	—	29533	29533	—	—
200	149.1	350 MCM	—	—	29534	29534	—	—	
250	186.4	500 MCM	—	—	29535	29535	—	—	

Values based on typical Full-Load Current (FLC) ratings of three-phase AC motors as published in NEC Table 430.250 (2011) multiplied by 125% per NEC article 430-22 (A) (2011). The ampacity ratings of the cables are based on NEC Table 310.15(B)(16) (2011). The VFD w/Signal ampacity values were de-rated to 80% per NEC Table 310.15 (B)(2)(a) (2011) due to the increased number of current-carrying conductors included in these cable(s).

Values based on typical Full-Load Current (FLC) ratings of three-phase AC motors as published in CEC Table 44 (2012) multiplied by 125% per CEC Section 28-112 (2012). The ampacity ratings of the cables are based on CEC Table 2 (2012). The VFD w/Signal ampacity values were de-rated to 80% per CEC Table 5C (2012) due to the increased number of current-carrying conductors included in these cable(s).

Consult drive/motor manufacturer for exact FLC ratings. Ampacity interpretations subject to user's local authority having jurisdiction.

VFD Cross Reference Guide (continued)

Voltage	HP	kW	Sizes	Classic VFD Part No.	Classic with Signal Pair Part No.	2 kV VFD Part No.	CSA VFD Part No.	LSZH VFD Part No.	Thermoset LSZH VFD, Marine Approvals Part No.
575 V 3Ø	10	7.5	16	29500	29510	—	—	29500T	29500X
			14	29501	29511	29536	29550C	29501T	29501X
	15	11.2	14	29501	29511	29536	29550C	29501T	29501X
			12	29502	29512	29537	29551C	29502T	29502X
	20	14.9	12	29502	29512	29537	29551C	29502T	29502X
			10	29503	29513	29538	29552C	29503T	29503X
	30	22.4	10	29503	29513	29538	29552C	29503T	29503X
	40	29.8	8	29504	—	29539	29553C	29504T	29504X
	50	37.3	6	29505	—	29540	29554C	29505T	29505X
	60	44.7	4	29506	—	29541	29555C	29506T	29506X
	100	74.6	2	29507	—	29542	29556C	29507T	29507X
			1	29528	—	29543	29557C	29528T	29528X
	125	93.2	1/0	29529	—	29544	29558C	29529T	29529X
			2/0	29530	—	29545	29559C	29530T	29530X
	150	111.9	3/0	29531	—	29546	29560C	29531T	29531X
			4/0	29532	—	29547	29561C	29532T	29532X
	200	149.1	250 MCM	—	—	29533	29533	—	—
	250	186.4	350 MCM	—	—	29534	29534	—	—
	350	261.0	500 MCM	—	—	29535	29535	—	—

Values based on typical Full-Load Current (FLC) ratings of three-phase AC motors as published in NEC Table 430.250 (2011) multiplied by 125% per NEC article 430-22 (A) (2011). The ampacity ratings of the cables are based on NEC Table 310.15(B)(16) (2011). The VFD w/Signal ampacity values were de-rated to 80% per NEC Table 310.15 (B)(2)(a) (2011) due to the increased number of current-carrying conductors included in these cable(s).

Values based on typical Full-Load Current (FLC) ratings of three-phase AC motors as published in CEC Table 44 (2012) multiplied by 125% per CEC Section 28-112 (2012). The ampacity ratings of the cables are based on CEC Table 2 (2012). The VFD w/Signal ampacity values were de-rated to 80% per CEC Table 5C (2012) due to the increased number of current-carrying conductors included in these cable(s).

Consult drive/motor manufacturer for exact FLC ratings. Ampacity interpretations subject to user's local authority having jurisdiction.

VFD Cross Reference Guide *(continued)*

VFD Supplier	VFD Name	VFD Supplier	VFD Name	VFD Supplier	VFD Name
ABB/Baldor	AC S	Easton/Cutler-Hammer	CFX	Rockwell/A-B	PowerFlex®
	ACH 501 (480 V AC, 208/230 V AC)		CPX		1336
	ACH550		H-Max		1305
	ACS 6000c		HVX	Schneider Electric	Altivar®
	ACQ		LCX		E-flex™
	Cascade		M-Max		M-Flex™
	Cyclo (Analog)		MVX		PowerGard™
	Cyclo (PSR)		NFX		S-Flex™
	MEGADRIVE-LCI		SC 9000	Siemens	MICROMASTER
	MEGASTAR A		SLX		SINAMICS
	SAMI MEGASTAR (W)	SPX	SED2		
	TYRAK-LCI	SVX	VBA		
	VS1SP	Mitsubishi	A500 Series	WEG	CFW
	VS1GV		A700 Series		EDP
	VS1PM		A701 Series		MVW
	Danfoss		AHF	D700 Series	Yaskawa
VLT® 12-Pulse			E500 Series	AC7	
VLT 2800			E700 Series	E7	
VLT 2800			E700SC Series	F7	
VLT AQUA FC 200		F700Series	G5HHP		
VLT FC 100		S500 Series	G7		
VLT FC 300		V500 Drives	J1000		
VLT High Power		OMRON	3G3JX	P1000	
VLT Low Harmonic			3G3MX2	P7	
VLT Micro			3G3RX	V1000	
			VS mini		
			Z1000		

Encoder Cables

Belden also offers the following standard cables for encoder applications. Encoder cables help feed information to the micro-processor regarding both the speed and the position of the rotor.

Part No.	Pairs	AWG
8790	1 (Power Supply)	18
9729	2	24
9730, 89730	3	24
9728	4	24
9892	4	20
9860	1 (Signal)	16

Classic and Symmetrical VFD Cables

Classic Foil/Braid Design



- Four-Conductor Cable (3 Circuit + Ground)
- Full-Size Insulated Ground
- Foil + Braid Shield
- 1000 V UL Flexible Motor Supply Cable
- 600 V UL TC-ER
- 1000 V CSA AWM I/II A/B FT4
- C(UL) 600 V Type CIC TC

Part No.	Conductor			OD (Nom)		Pulling Tension (Max)		Bend Radius (Min)		Additional Features/Ratings
	AWG	mm ²	Stranding	Inch	mm	Lbs	N	Inch	mm	
Stranded TC Conductors • XLP Insulation (PVC for Ground) • Overall Beldfoil® + 85% TC Braid Shielding • Black PVC Jacket • TC Drain Wire (Sized Same as Conductors)										
29500	16	1.3	26 x 30	.53	13.46	128	570	4.3	109.2	+90 °C Wet/Dry Sunlight Res Oil Res UL Direct Burial IEEE 1202/383 XHHW-2, RHW-2 Conductors (16 AWG: XHHW-2 only) MSHA* P-07-KA070003
29501	14	2.0	41 x 30	.60	15.24	212	943	4.8	121.9	
29502	12	3.3	65 x 30	.65	16.51	336	1495	5.2	132.0	
29503	10	5.4	105 x 30	.69	17.53	592	2634	5.5	139.7	
29504	8	8.6	7 x 19 x 29	.93	23.61	768	3418	7.5	190.5	
29505	6	13.8	7 x 19 x 27	1.02	25.91	1220	5429	8.2	203.2	
29506	4	21.6	7 x 19 x 25	1.16	29.46	1940	8633	9.3	236.2	
29507	2	34.4	7 x 19 x 23	1.31	33.27	3088	13,742	10.8	273.1	

Conductor Color Coding: ICEA Method 4: Black and Numbered, Green/Yellow Ground.

Classic Symmetrical Design



- Three-Conductor Cable (3 Circuit + 3 Ground)
- Dual Spiral Copper Tape Shield
- 1000 V UL Flexible Motor Supply Cable
- 600 V UL 1277 Type TC-ER
- 1000 V CSA AWM I/II A/B FT4
- C(UL) 600 V Type RW90 TC

Part No.	Conductor			OD (Nom)		Pulling Tension (Max)		Bend Radius (Min)		Additional Features/Ratings
	AWG	mm ²	Stranding	Inch	mm	Lbs	N	Inch	mm	
Stranded TC Conductors • XLP Insulation (PVC for Ground) • Dual Spiral Copper Tape Shield • Black PVC Jacket • BC Drain Wire (Sized Same as Conductors)										
29528	1	43.2	7 x 19 x 22	1.20	30.48	2650	11,788	12.0	304.8	+90 °C Wet/Dry Sunlight Res Oil Res UL Direct Burial IEEE 1202/383 XHHW-2 Conductors MSHA* P-07-KA070003
29529	1/0	53.5	7 x 19 x 21	1.29	32.77	3537	15,733	12.9	327.7	
29530	2/0	69.0	7 x 19 x 20	1.40	35.56	4200	18,682	14.0	355.6	
29531	3/0	85.0	7 x 19 x 19	1.52	38.61	5025	22,352	15.2	386.1	
29532	4/0	107.2	7 x 19 x 18	1.68	42.67	6670	29,670	16.8	426.7	

Conductor Color Coding: ICEA Method 4: Black and Numbered, Green/Yellow Ground.

Classic Foil/Braid Design • Signal Pair



- Four-Conductor Cable (3 Circuit + Ground)
- Full-Size Insulated Ground
- 16 AWG Stranded (26 x 30) Shielded Signal Pair
- Foil + Braid Shield
- 1000 V UL Flexible Motor Supply Cable
- 600 V UL TC-ER
- 1000 V CSA AWM I/II A/B FT4
- C(UL) 600 V Type CIC TC

Part No.	Conductor			OD (Nom)		Pulling Tension (Max)		Bend Radius (Min)		Additional Features/Ratings
	AWG	mm ²	Stranding	Inch	mm	Lbs	N	Inch	mm	
Stranded TC Conductors • XLP Insulation (PVC for Ground) • Overall Duofoil® + 85% TC Braid Shielding • Black PVC Jacket • TC Drain Wire (Sized Same as Conductors)										
29510	16	1.3	26 x 30	.75	19.05	272	1210	7.5	190.5	IEEE 1202/383 +90 °C Wet/Dry Sunlight Res Oil Res UL Direct Burial XHHW-2, RHW-2 Conductors (16 AWG: XHHW-2 only) MSHA* P-07-KA070003
29511	14	2.1	41 x 30	.82	20.83	368	1638	8.2	208.3	
29512	12	3.3	65 x 30	.90	22.86	527	2345	9.0	228.6	
29513	10	5.4	105 x 30	.99	25.15	718	3195	9.9	251.5	

Conductor Color Coding: ICEA Method 4: Black and Numbered, Green/Yellow Ground.

BC = Bare Copper • TC = Tinned Copper • PVC = Polyvinyl Chloride • XLP = Cross-Linked Polyethylene | * MSHA = Mine Safety and Health Administration

Classic and Symmetrical VFD Cables

Classic Foil/Braid Design • 2kV



- Four-Conductor Cable (3 Circuit + Ground)
- Full-Size Insulated Ground
- Foil + Braid Shield
- 2000 V UL Flexible Motor Supply Cable
- 2000 V UL TC-ER
- 1000 V CSA AWM I/II A/B FT4
- C(UL) 600 V Type CIC TC

Part No.	Conductor			OD (Nom)		Pulling Tension (Max)		Bend Radius (Min)		Additional Features/Ratings
	AWG	mm ²	Stranding	Inch	mm	Lbs	N	Inch	mm	
Stranded TC Circuit Conductors • XLP Insulation (PVC for Ground) • Overall Duofoil + 85% TC Braid Shielding • Black PVC Jacket • TC Drain Wire (Sized Same as Conductors)										
29536	14	2.1	41 x 30	.68	17.30	212	943	6.8	172.72	
29537	12	3.3	65 x 30	.72	18.30	336	1495	7.3	185.42	+90 °C Wet/Dry Sunlight Res Oil Res UL Direct Burial IEEE 1202/3837 XHHW-2, RHW-2 Conductors MSHA* P-07-KA070003
29538	10	5.4	105 x 30	.79	20.10	592	2634	7.9	200.70	
29539	8	8.6	7 x 19 x 29	.96	24.40	768	3418	9.6	243.84	
29540	6	13.8	7 x 19 x 27	1.07	26.92	1220	5429	10.6	269.24	
29541	4	21.6	7 x 19 x 25	1.21	30.50	1940	8633	12.1	307.34	
29542	2	34.4	7 x 19 x 23	1.36	34.54	3088	13,742	13.6	345.44	

Conductor Color Coding: ICEA Method 4: Black and Numbered, Green/Yellow Ground.

Classic Symmetrical Design • 2kV



- Three-Conductor Cable (3 Circuit + 3 Ground)
- Dual Spiral Copper Tape Shield
- 2000 V UL Flexible Motor Supply Cable
- 2000 V UL TC-ER
- 1000 V CSA AWM I/II A/B FT4
- C(UL) 2000 V Type RW90 TC

Part No.	Conductor			OD (Nom)		Pulling Tension (Max)		Bend Radius (Min)		Additional Features/Ratings
	AWG	mm ²	Stranding	Inch	mm	Lbs	N	Inch	mm	
Stranded TC Conductors • XLP Insulation • Dual Spiral Copper Tape Shield • Black PVC Jacket • BC Ground Conductors										
29543	1	43.2	7 x 19 x 22	1.36	34.54	2650	11,788	13.6	345.44	IEEE 1202/383 Sunlight Res Oil Res UL Direct Burial XHHW-2, RHW-2 Conductors +90 °C Wet/Dry MSHA* P-07-KA070003
29544	1/0	53.5	7 x 19 x 21	1.45	36.83	3537	15,733	14.5	368.30	
29545	2/0	69.0	7 x 19 x 29	1.56	39.62	4200	18,682	15.6	396.24	
29546	3/0	85.0	7 x 19 x 19	1.75	44.50	5025	22,352	17.5	444.50	
29547	4/0	107.2	7 x 19 x 18	1.88	47.80	6670	29,670	18.8	477.52	

Conductor Color Coding: ICEA Method 4: Black and Numbered.

Symmetrical Design • 2kV MCM Size



- Three-Conductor Cable (3 Circuit + 3 Ground)
- Dual Spiral Copper Tape Shield
- 2000 V UL TC-ER
- 1000 V CSA 22.2 No. 230 TC

Part No.	Conductor			OD (Nom)		Pulling Tension (Max)		Bend Radius (Min)		Additional Features/Ratings
	MCM	mm ²	Stranding	Inch	mm	Lbs	N	Inch	mm	
Stranded BC Conductors • XLP Insulation • Dual Spiral Copper Tape Shield • Black PVC Jacket • BC Ground Conductors										
29533	250	125	37 x .0822	1.91	48.56	6000	26,688	34.4	873	IEEE 1202/383 Sunlight Res Oil Res UL Direct Burial CSA FT4 RHW-2, RW90 Conductors +90 °C Wet/Dry
29534	350	185	37 x .0973	2.13	54.18	8400	37,363	38.4	975	
29535	500	240	37 x .1162	2.41	61.16	12,000	53,376	43.4	1102	

Conductor Color Coding: ICEA Method 4: Black and Numbered.

BC = Bare Copper • TC = Tinned Copper • PVC = Polyvinyl Chloride • XLP = Cross-Linked Polyethylene | * MSHA = Mine Safety and Health Administration

Low Smoke Zero Halogen VFD Cables

Classic Foil/Braid Design • Low Smoke Zero Halogen



- Four-Conductor Cable (3 Circuit + Ground)
- Full-Size Insulated Ground
- Foil + Braid Shield
- 1000 V UL Flexible Motor Supply Cable
- 600 V UL TC-ER
- 1000 V CSA AWM I/II A/B FT4

Part No.	Conductor			OD (Nom)		Pulling Tension (Max)		Bend Radius (Min)		Additional Features/Ratings
	AWG	mm ²	Stranding	Inch	mm	Lbs	N	Inch	mm	
Stranded TC (Circuit), TC (Ground) Conductors • XLP Insulation • Overall Beldfoil® + 85% TC Braid Shielding • Black Haloarrest® Jacket										
29500T	16	1.3	26 x 30	.53	13.46	128	570	4.3	109.2	IEEE 1202/383 Sunlight Res UL Direct Burial XHHW-2, RHW-2 Conductors (16 AWG: XHHW-2 only) +90 °C Wet/Dry MSHA* P-07-KA070003
29501T	14	2.1	41 x 30	.60	15.24	212	943	4.8	121.9	
29502T	12	3.3	65 x 30	.65	16.51	336	1495	5.2	132.0	
29503T	10	5.4	105 x 30	.69	17.53	592	2634	5.5	139.7	
29504T	8	8.6	7 x 19 x 29	.93	23.62	768	3418	7.5	190.5	
29505T	6	13.8	7 x 19 x 27	1.02	25.91	1220	5429	8.2	203.2	
29506T	4	21.6	7 x 19 x 25	1.16	29.46	1940	8633	9.3	236.2	
29507T	2	34.4	7 x 19 x 23	1.31	33.27	3088	13,742	10.8	273.1	

Conductor Color Coding: ICEA Method 4: Black and Numbered, Green/Yellow Ground.

Classic Symmetrical Design • Low Smoke Zero Halogen



- Three-Conductor Cable (3 Circuit + 3 Ground)
- Dual Spiral Copper Tape Shield
- 1000 V UL Flexible Motor Supply Cable
- 600 V UL TC-ER
- 1000 V CSA AWM I/II A/B FT4

Part No.	Conductor			OD (Nom)		Pulling Tension (Max)		Bend Radius (Min)		Additional Features/Ratings
	AWG	mm ²	Stranding	Inch	mm	Lbs	N	Inch	mm	
Stranded TC (Circuit), BC (Ground) Conductors • XLP Insulation • Dual Spiral Copper Tape Shield • Black PVC Jacket										
29528T	1	43.2	7 x 19 x 22	1.20	30.48	2650	11,788	12.0	304.8	IEEE 1202/383 Sunlight Res UL Direct Burial XHHW-2 Conductors +90 °C Wet/Dry MSHA* P-07-KA070003
29529T	1/0	53.5	7 x 19 x 21	1.29	32.77	3537	15,733	12.9	327.7	
29530T	2/0	69.0	7 x 19 x 20	1.40	35.56	4200	18,682	14.0	355.6	
29531T	3/0	85.0	7 x 19 x 19	1.52	38.61	5025	22,352	15.2	386.1	
29532T	4/0	107.2	7 x 19 x 18	1.68	42.67	6670	29,670	16.8	426.7	

Conductor Color Coding: ICEA Method 4: Black and Numbered, Green/Yellow Ground.

BC = Bare Copper • TC = Tinned Copper • PVC = Polyvinyl Chloride • XLP = Cross-Linked Polyethylene | * MSHA = Mine Safety and Health Administration

Low Smoke Zero Halogen VFD Cables

**Classic Foil/Braid Design •
Thermoset Low Smoke Zero
Halogen • Marine Certified**



- Four-Conductor Cable (3 Circuit + Ground)
- Full-Size Insulated Ground
- Foil + Braid Shield

- 1000 V UL Flexible Motor Supply Cable
- 600 V UL TC-ER
- CSA FT4
- Marine Approvals: ABS, UL 1309, IEEE 45, IEEE 1580 Type P

Part No.	Conductor			OD (Nom)		Pulling Tension (Max)		Bend Radius (Min)		Additional Features/Ratings
	AWG	mm ²	Stranding	Inch	mm	Lbs	N	Inch	mm	
Stranded TC Conductors • XLP Insulation • Overall Beldfoil® + 85% TC Braid Shielding • Black HaloarrestXLink™-2 Jacket										
29500X	16	1.3	26 x 30	.53	13.46	128	570	4.3	109.2	IEEE 1202/383 Sunlight Res Oil Res II IEC 60811-2-1 Hydrocarbon Resistant XHHW-2, RHW-2 Conductors (16 AWG: XHHW-2 only) +90 °C Wet/Dry MSHA Approved* Suitable for Class I, II & III, Division 2 Hazardous Locations
29501X	14	2.1	41 x 30	.60	15.24	212	943	4.8	121.9	
29502X	12	3.3	65 x 30	.65	16.51	336	1495	5.2	132.0	
29503X	10	5.4	105 x 30	.69	17.53	592	2634	5.5	139.7	
29504X	8	8.6	7 x 19 x 29	.93	23.62	768	3418	7.5	190.5	
29505X	6	13.8	7 x 19 x 27	1.02	25.91	1220	5429	8.2	203.2	
29506X	4	21.6	7 x 19 x 25	1.16	29.46	1940	8633	9.3	236.2	
29507X	2	34.4	7 x 19 x 23	1.31	33.27	3088	13,742	10.8	273.1	

Conductor Color Coding: ICEA Method 4: Black and Numbered, Green/Yellow Ground.

**Classic Symmetrical Design •
Thermoset Low Smoke Zero
Halogen • Marine Certified**



- Three-Conductor Cable (3 Circuit + 3 Ground)
- Dual Spiral Copper Tape Shield

- 1000 V UL Flexible Motor Supply Cable
- 600 V UL TC-ER
- CSA FT4
- Marine approvals: ABS, UL 1309 Type, IEEE 45, IEEE 1580 Type P

Part No.	Conductor			OD (Nom)		Pulling Tension (Max)		Bend Radius (Min)		Additional Features/Ratings
	AWG	mm ²	Stranding	Inch	mm	Lbs	N	Inch	mm	
Stranded TC (Circuit), BC (Ground) Conductors • XLP Insulation • Dual Spiral Copper Tape Shield • Black HaloarrestXLink-2 Jacket										
29528X	1	43.2	7 x 19 x 22	1.20	30.48	2650	11,788	12.0	304.8	IEEE 1202/383 Sunlight Res Oil Res II IEC 60811-2-1 Hydrocarbon Resistant XHHW-2 Conductors +90 °C Wet/Dry MSHA Approved* Suitable for Class I, II & III, Division 2 hazardous locations
29529X	1/0	53.5	7 x 19 x 21	1.29	32.77	3537	15,733	12.9	327.7	
29530X	2/0	69.0	7 x 19 x 20	1.40	35.56	4200	18,682	14.0	355.6	
29531X	3/0	85.0	7 x 19 x 19	1.52	38.61	5025	22,352	15.2	386.1	
29532X	4/0	107.2	7 x 19 x 18	1.68	42.67	6670	29,670	16.8	426.7	

Conductor Color Coding: ICEA Method 4: Black and Numbered.

BC = Bare Copper • TC = Tinned Copper • PVC = Polyvinyl Chloride • XLP = Cross-Linked Polyethylene | * MSHA = Mine Safety and Health Administration

Armored VFD Cables

Interlocked Armor

Belden armored VFD cables are available in interlocked aluminum or steel type metal clad (MC) constructions. Belden MC cables are designed to meet demanding industrial needs with rugged durability and corrosion resistance with flexibility and easy handling.

The products use Belden Classic or Classic Symmetrical designs.

Classic Foil/Braid Design • Armored



- Four-Conductor Cable (3 Circuit + Ground)
- Foil + Braid Shield
- 600 V UL MC
- NEC Hazardous Location: Classes I and II, Div. II

Part No.		Conductor		Additional Features/Ratings
Aluminum	Steel	AWG	mm ²	
Stranded TC Conductors • XLP Insulation (PVC for Ground) • Overall Beldfoil® + 85% TC Braid Shielding • Black PVC Jacket				
1229500	1329500	16	1.3	IEEE 1202/383 (70,000 BTU) Sunlight Res Oil Res UL Direct Burial XHHW-2, RHW-2 Conductors (16 AWG, XHHW-2 Only) +90 °C Wet/Dry
1229501	1329501	14	2.1	
1229502	1329502	12	3.3	
1229503	1329503	10	5.4	
1229504	1329504	8	8.6	
1229505	1329505	6	13.8	
1229506	1329506	4	21.6	
1229507	1329507	2	34.4	

Conductor Color Coding: ICEA Method 4: Black and Numbered, Green/Yellow Ground.

Classic Symmetrical Design • Armored



- Three-Conductor Cable (3 Circuit + 3 Ground)
- Dual Spiral Copper Tape Shield
- 600 V UL MC
- NEC Hazardous Location: Classes I and II, Div. II

Part No.		Conductor		Additional Features/Ratings
Aluminum	Steel	AWG	mm ²	
Stranded TC (Circuit), BC (Ground) Conductors • XLP Insulation (PVC for Ground) • Dual Copper Tape Shield • Black PVC Jacket				
1229528	1329528	1	43.2	IEEE 1202/383 (70,000 BTU) Sunlight Res Oil Res UL Direct Burial XHHW-2 Rated Circuit Conductors +90 °C Wet/Dry
1229529	1329529	1/0	53.5	
1229530	1329530	2/0	69.0	
1229531	1329531	3/0	85.0	
1229532	1329532	4/0	107.2	

Conductor Color Coding: ICEA Method 4: Black and Numbered, Green/Yellow Ground.

BC = Bare Copper • TC = Tinned Copper • PVC = Polyvinyl Chloride • XLP = Cross-Linked Polyethylene

CSA VFD Cables
1000 V CSA Cables

CSA Symmetrical Design



- Three-Conductor Cable (3 Circuit + 3 Ground)
- Dual Spiral Copper Tape Shield
- 1000 V CSA TC
- CSA C22.2 #230
- CSA C22.2 #38
- CSA FT-4

Part No.	Conductor			OD (Nom)		Pulling Tension (Max)		Bend Radius (Min)		Additional Features/Ratings
	AWG	mm ²	Stranding	Inch	mm	Lbs	N	Inch	mm	
Stranded BC Conductors • XLP Insulation • Dual Spiral Copper Cable Shield • Black PVC Jacket										
29550C	14	2.1	7 x 22	0.43	10.92	162	75	4.3	109.2	IEEE 1202/383 Sunlight Res Oil Res Direct Burial RW90 Conductors +90 °C Wet/Dry
29551C	12	3.3	7 x 20	0.46	11.68	258	117	4.6	116.8	
29552C	10	5.4	7 x 18	0.51	12.95	444	201	5.1	129.5	
29553C	8	8.6	7 x 16	0.65	16.51	576	261	6.5	165.1	
29554C	6	13.8	7 x 14	0.72	18.28	915	415	7.3	185.4	
29555C	4	21.6	7 x 12	0.83	21.08	1450	658	8.3	210.8	
29556C	2	34.4	7 x 10	0.99	25.15	2300	1043	10.0	254.0	
29557C	1	43.2	19 x 14	1.13	28.70	2650	1202	11.5	292.1	
29558C	1/0	53.5	19 x 13	1.21	30.73	3537	1604	12.3	312.4	
29559C	2/0	69.0	19 x 12	1.31	33.27	4200	1905	13.3	337.8	
29560C	3/0	85.0	19 x 11	1.42	36.07	5025	2279	14.3	363.2	
29561C	4/0	107.2	19 x 10	1.54	39.12	6670	3025	15.5	393.7	

Conductor Color Coding: ICEA Method 4: Black and Numbered.



Power & Control Sensor & Actuator Cables

Section Table of Contents

Power & Control	Page
Sensor & Actuator Cables	
Overview	152
PVC Sensor & Actuator Cables	153
PUR Sensor & Actuator Cables	154
PUR Distribution Boxes Cables	155

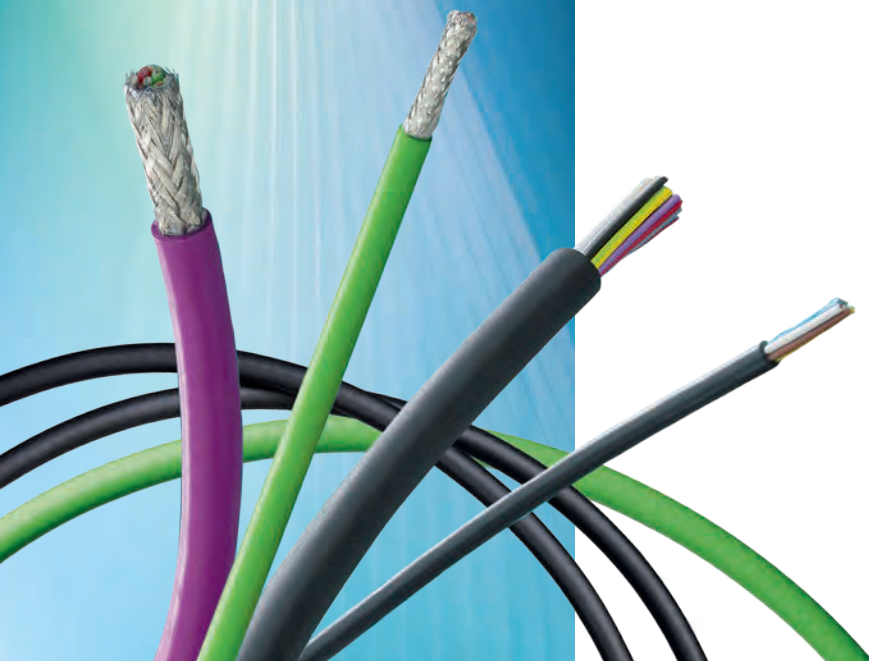

Sensor & Actuator Cables



The sensor/actuator range are signal cables, connecting automation systems end points (e.g., sensors) to the next layer (e.g. I/O devices). These applications require cables with high flexibility and resistance to tough industrial environments (e.g., oil, temperature variation, chemicals), low data rates and reliable quality.

Product Features

- Drag chain suitability/trailing-resistant
 - Bending radius 10xD
 - Acceleration 5 m/s²
 - Path feed rate 200 m/min at 5 m horizontal path
 - Guaranteed from 2 million bending cycles to 10 million bending cycles
- Torsion-resistant
 - >5 million cycles guaranteed
 - ± 360° per 1 m length
- Resistance to coolants and lubricants
 - Polyurethane outer jacket for longer service life
 - Lower maintenance costs
- UL, ROHS compliant
- No halogens, LABS free, phosphorus free
- On-machine industrial resistance requirements: flexible, oil resistant, tough cable jackets, e.g. PURs
- High temperature resistance +80 °C
- Perfectly round cable for IP67 assemblies requirements
- Multiple put-up lengths (100 m, 3000 m, 5000 m, etc.)

Benefits

- With an experience of over 110 years, Belden evolved its manufacturing sites to deliver maximum performance and total reliability. High levels of quality in centricity, roundness, strippability and consistent jacket thickness are ensured through the production quality systems, in line management, centricity control systems, stripping force testing, UL and ISO 9001:2000 certified facilities.
- Belden guarantees the quality of its cables by using high quality materials, approved by international authorities such as IEC and UL.

Applications

On-machine applications & peripheral devices to PLC controllers:

- Sensor-Actuator links
- Sensors/Actuators to I/O Distributor Boxes
- Sensors/Actuators to Field Devices

Belden Sensor & Actuator Cables

Robust Cables for Sustainable Performance

Automation technologies make things move. They sense, they control, and they inspect. Automation also means intelligent networking of control systems, sensors and actuators. High performance cables have changed the face of modern factories, manufacturing processes and the industrial infrastructure. Today's industrialists expect reliability and take long lifecycles and high performance for granted. Very often this applies under even the most rugged conditions, which means in practice that they can concentrate on their own work.

Belden offers a wide range of industrial sensor cables, UL style and tested for 1 up to 5 million cycles trailing or torsion applications, have a durable outside sheath, extremely small bending radiuses and are highly resistant to oil and chemicals. They are particularly suitable for use in metal-cutting machines and installations.

PVC Sensor/Actuator Cables

PVC (Polyvinylchloride) is a general purpose thermoplastic jacketing material, which has good mechanical strength in dry, damp or wet rooms and outdoors (fixed installations).

- Outstanding resistance to chemicals
- PVC screened
- Cu screen: Wire Ø 0.10 mm, tinned/coverage 85% +/- 5%
- Recommended for applications in food processing equipment
- Recommended for applications in packaging, assembly and automatic production lines

PVC Sensor & Actuator Cable



Part No.	Conductors	Stranding	OD (Nom)		Voltage	Temperature Fixed Installation (°C)	UL Style	Additional Features/Ratings
			Inch	mm				

Copper Section 0.25 mm²

Stranded BC Conductors • PVC Insulation • PVC Jacket • LABS Free								
70202E	3	32 x 0.10 mm	0.197	5.0	300 V	-40 to +80	UL AWM 2464	1 Million Continuous Flex Cycles, Trailing Acids and Chemical Cleaning Agents Resistant

Copper Section 0.34 mm²

Stranded BC Conductors • PVC Insulation • PVC Jacket • LABS Free								
70201E	3	42 x 0.10 mm	0.197	5.0	300 V	-40 to +80	UL AWM 2464	1 Million Continuous Flex Cycles, Trailing Acids and Chemical Cleaning Agents Resistant
70203E	4	42 x 0.10 mm	0.224	5.7	300 V	-40 to +80	UL AWM 2464	

BC = Bare Copper • PVC = Polyvinyl Chloride

Belden Sensor & Actuator Cables

PUR Sensor & Actuator Cables

Product Features

- Low outer diameter and tolerances
 - Process security during sensor production
 - Optimum processing in the sensor
- Drag chain suitability
 - Bending radius 10 x D
 - Acceleration 5 m/s²
 - Path feed rate 200 m/min at 5 m horizontal path
 - Guaranteed bending cycles 5 millions
- Free of halogen and substances detrimental to paint adhesion
 - Decrease in fire load
 - Can also be used in paint shops for example
- Resistance to coolants and lubricants
 - Polyurethane outer jacket for longer service life
 - Lower maintenance costs
- Color black – suitable for any device design
- UL approved
- Torsion-resistant
 - >5 million cycles guaranteed
 - ± 360° per 1 m length

PUR Sensor & Actuator Cable



Part No.	Conductors	Stranding	OD (Nom)		Voltage	Temperature Fixed Installation (°C)	UL Style	Additional Features/Ratings
			Inch	mm				

Copper Section 0.14 mm²

Stranded BC Conductors • PP Insulation • PUR Jacket • Halogen Free • LABS Free								
70252PU	3	72 x 0.05 mm	0.114	2.9	300 V	-50 to +80	UL AWM 20549	5 Million Continuous Flex Cycles, Trailing Sunlight and Oil Resistant
70254PU	3	72 x 0.05 mm	0.114	2.9	300 V	-50 to +80	UL AWM 20549	5 Million Continuous Flex Cycles, Trailing Weldsplatter Resistant Sunlight and Oil Resistant
70251PU	4	18 x 0.10 mm	0.138	3.5	300 V	-50 to +80	UL AWM 20549	5 Million Continuous Flex Cycles, Trailing Sunlight and Oil Resistant

Copper Section 0.25 mm²

Stranded BC Conductors • PP Insulation • PUR Jacket • Halogen Free • LABS Free								
70262PU	6	32 x 0.10 mm	0.200	5.1	300 V	-50 to +80	UL AWM 20549	2 Million Continuous Flex Cycles, Trailing Sunlight and Oil Resistant
70263PU	8	32 x 0.10 mm	0.236	6.0	300 V	-50 to +80	UL AWM 20549	
70264PU	10	32 x 0.10 mm	0.248	6.3	300 V	-50 to +80	UL AWM 20549	
70265PU	12	32 x 0.10 mm	0.251	6.4	300 V	-50 to +80	UL AWM 20549	
70268PU	14	32 x 0.10 mm	0.283	7.2	300 V	-50 to +80	UL AWM 20549	

Copper Section 0.34 mm²

Stranded BC Conductors • PP Insulation • PUR Jacket • Halogen Free • LABS Free								
70256PU	3	42 x 0.10 mm	0.169	4.3	300 V	-50 to +80	UL AWM 20549	5 Million Continuous Flex Cycles, Trailing Sunlight and Oil Resistant
70257PU	4	42 x 0.10 mm	0.185	4.7	300 V	-50 to +80	UL AWM 20549	
70261PU	6	42 x 0.10 mm	0.236	6.0	300 V	-50 to +80	UL AWM 20549	2 Million Continuous Flex Cycles, Trailing Sunlight and Oil Resistant
Stranded BC Conductors • PETE Insulation • Special PUR • Halogen Free • LABS Free								
70269PU	4	42 x 0.10 mm	0.224	5.7	300 V	-50 to +80	UL AWM 20549	5 Million Continuous Flex Cycles Robot Cable: Trailing and Torsion Weldsplatter Resistant Sunlight and Oil Resistant

Copper Section 0.50 mm²

Stranded BC Conductors • PP Insulation • PUR Jacket • Halogen Free • LABS Free								
70258PU	3	16 x 0.20 mm	0.181	4.6	300 V	-50 to +80	UL AWM 20549	5 Million Continuous Flex Cycles, Trailing Sunlight and Oil Resistant
70259PU	5	16 x 0.20 mm	0.213	5.4	300 V	-50 to +80	UL AWM 20549	

BC = Bare Copper • PP = Polypropylene • PUR = Polyurethane • PETE = Polyethylene Terephthalate

Belden Sensor & Actuator Cables

PUR Distribution Boxes Cables



Part No.	Conductors	Stranding	OD (Nom)		Voltage	Temperature Fixed Installation (°C)	UL Style	Additional Features/Ratings
			Inch	mm				

Copper Section 0.50 mm² & 1.00 mm²

Stranded BC Conductors • PP Insulation • PUR Jacket • Halogen Free • LABS Free								
70260PU	12 x 0.50 mm ² & 3 x 1.00 mm ²	64 x 0.10 mm 128 x 0.10 mm	0.358	9.1	300 V	-25 to +80	UL AWM 20549	2 Million Continuous Flex Cycles, Trailing Sunlight and Oil Resistant
70266PU	16 x 0.50 mm ² & 3 x 1.00 mm ²	64 x 0.10 mm 128 x 0.10 mm	0.457	11.6	300 V	-25 to +80	UL AWM 20549	
70267PU	8 x 0.50 mm ² & 3 x 1.00 mm ²	64 x 0.10 mm 128 x 0.10 mm	0.366	9.3	300 V	-25 to +80	UL AWM 20549	

BC = Bare Copper • PP = Polypropylene • PUR = Polyurethane

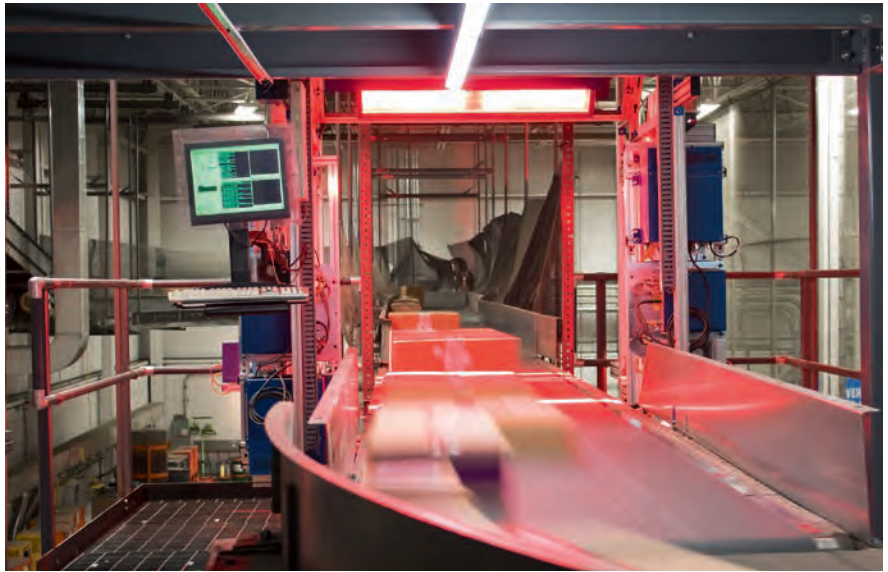

High performance cabling solutions have changed the face of modern production facilities.

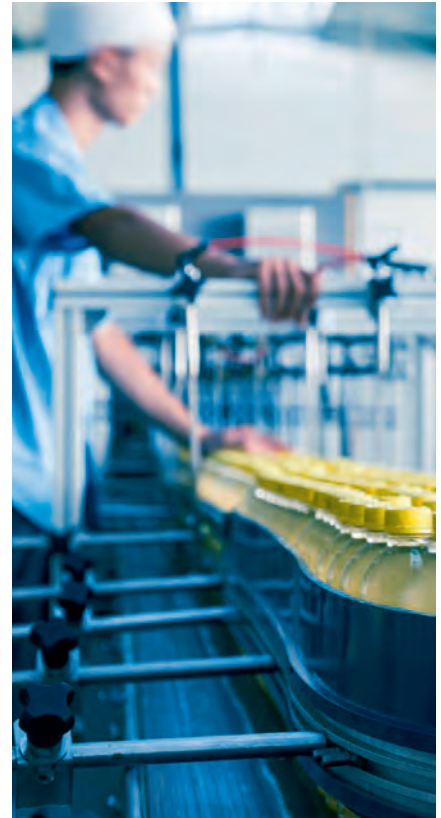



Power & Control Hook-up & Lead Wire

Section Table of Contents

Power & Control	Page
Hook-up & Lead Wire	
Overview	158
Introduction: UL Style & CSA Type Listings	159
PVC	160–163
PVC Wire Dispenser Kits	164
GreenChoice™ PPO	165
TFE	166–167
EPDM	168–169
XL-DUR®	170
XL-DUR® (High-Temperature) and SIS (Switchboard) Wire	171
Chlorosulfonated Polyethylene	172–173
Neoprene	174
Silicone Rubber	175–176
Mercury Switch	177
High-Voltage Leads	177
Test Prod Wire	177
Magnet Wire	178
Shielding and Bonding Cable, Direct Burial Cable, Bus Bar, and Antenna Wire	179
Technical Information	180–186



Hook-up & Lead Wire



Belden hook-up and lead wire products are manufactured in a variety of materials, sizes and designs to meet rigid industry and government specifications. Manufactured in-house, our hook-up and lead wire manufacturing process begins with copper rod.

Product Features

- Variety of jacket materials: PVC, FEP, Teflon, EPDM, XL-DUR, CSPE, Neoprene, Silicone rubber
- Temperature range up to +200 °C silicon
- Color stability
- Fast stripping
- Oil resistant
- UL approval

Benefits

Belden's rubber formulation and plastic mixing facilities give us complete control of the product from start to finish. As a result, consistent quality of these products is always assured.

Applications

Belden's hook-up and lead wire products can be used in a wealth of applications, including interconnection circuits, internal wiring of computer and data processing equipment, appliances, lighting, motor leads, heating and cooling equipment, harness fabrication, and automotive.



Introduction

CSPE and Neoprene Constructions

These constructions may require a special topcoat to facilitate printing by customers. Minimum order is 5000 feet per AWG. Please order the standard item and specify "Top-Coated" and specify color. Orders must be in multiples of standard packages.

Price and delivery information is available upon request.

Manufacturer's Identification

Identification of the hook-up and lead wire is provided by our UL and CSA file numbers or printed name on the wire jacket.

Manufacturer's Identification

UL/CSA	File Number	Style
UL	E-12683	1XXX, 2XXX, 3XXX, 4XXX, 5XXX
	E-53518	MTW
	E-6934	SF-1, SFF-1, SF-2, SFF-2
	E-3917	SIS
CSA	LL-7874	All Types

Index by UL Voltage and Temperature Rating

Hook-up & Lead Wire Section	Materials
300 V, +80 °C	PVC
300 V, +90 °C	Neoprene
300 V, +105 °C	Chlorosulfonated Polyethylene (CSPE)
	XL-DUR®
300 V, +200 °C	TFE
600 V, +90 °C	Neoprene
	SIS
600 V, +105 °C	CSPE
	PPO
	PVC
600 V, +125 °C	EPDM
	XL-DUR
600 V, +150 °C	EPDM
	Silicone Rubber, Braidless
	Silicone Rubber, Glass Braid
	Silicone Rubber, Mercury Switch Wire
	XL-DUR
600 V, +200 °C	Silicone Rubber, Braidless
	Silicone Rubber, Glass Braid
5000 V	CSPE
7500 V, +150 °C	EPDM

Appliance Wiring Material (AWM)

Appliance Wiring Material is Underwriter Laboratories, Inc.'s recognized covering of insulated wire and cable intended for internal wiring of appliances and equipment. Each construction satisfies the requirements for use in particular applications. Wiring materials recognized under this classification bear the "Underwriters' Appliance Wiring Material Label".

UL and CSA Type by Belden Series

UL Style	CSA Type	Belden Series Number	Temperature Rating, °C
1007	TR-64	328	+80
1015	TEW	327, 99, 89	+105
1028	TEW	99, 89	+105
1061	AWM	99	+80
1180	—	830	+200
1213	—	830	+105
1283	TEW	99	+105
1371	—	830	+105
1569	TRSR-64	99	+105
1855	—	—	+80
3044	CL902	315	+90
3046	CL903	315, 325	+90
3048	CL902	315	+90
3049	CL902	315	+90
3069	SEWF-2	308	+150
3070	SEWF-2	308	+150
3071	SEW-2	324	+200
3074	SEW-2	324	+200
3075	SEW-2	324	+200
3101	SEWF-2	308	+150
3123	—	340	+150
3125	SEW-2	308	+200
3126	SEW-2	308	+200
3135	—	334	+200
3173	CL1251	356	+125
3190	CL1052	349	+105
3191	CL1052	344	+105
3192	CL1052	344	+105
3193	CL1052	344	+105
3195	CL1251	356	+125
3196	CL1251	356	+125
3199	CL1054	357	+105
3212	AWM	333	+150
3213	AWM	333	+150
3214	AWM	333	+150
3239	—	—	+80
3321	AWM	354	+150
3340	CL1254	371	+150
3374	CL1254	371	+150
3436	CL1251	354	+150
3484	AWM	372	+125
3499	—	375	+150
11028	—	391	+105
SIS	—	310	+90

CSPE = Chlorosulfonated Polyethylene • EPDM = Ethylene-Propylene Diene Elastomer • PPO = Polyphenylene Oxide • PVC = Polyvinyl Chloride • PVDF = Polyvinylidene Fluoride • TFE = Tetrafluoroethylene

PVC

UL AWM Style 1061
300 V, +80 °C (UL & CSA)

- Tinned Copper Conductors
- Semi-rigid PVC Insulation
- CSA AWM



Solid conductors suitable for wire wrap applications

Part No.	AWG	Stranding	OD (Nom)		Insulation Thickness	
			Inch	mm	Inch	mm
9978	30	Solid	.030	.76	.010	.25
9987	30	7 x 38	.032	.81	.010	.25
9977	28	Solid	.033	.84	.010	.25
9986	28	7 x 36	.035	.89	.010	.25
9976	26	Solid	.036	.91	.010	.25
9985	26	7 x 34	.039	.99	.010	.25
9975	24	Solid	.040	1.02	.010	.25
9984	24	7 x 32	.044	1.12	.010	.25
9979	22	Solid	.047	1.19	.010	.25
9983	22	7 x 30	.050	1.27	.010	.25
9982	20	7 x 28	.057	1.45	.010	.25
9917	20	10 x 30	.056	1.42	.010	.25
9911	18	16 x 30	.067	1.70	.010	.25
9981	18	19 x 30	.066	1.68	.010	.25
9980	16	19 x 28	.078	1.98	.010	.25
9909	16	26 x 30	.080	2.03	.010	.25

For available colors and put-ups, see the on-line Belden Technical Data Sheet for the part number at www.belden.com

PVC

**UL AWM Style 1007
300 V, +80 °C (UL)**



- Tinned Copper Conductors
- PVC Insulation
- VW-1

Rated 2500 V peak for electronic circuits, and internal wiring of electronic and electrical equipment

Part No.	AWG	Stranding	OD (Nom)		Insulation Thickness	
			Inch	mm	Inch	mm
9930	30	7 x 38	.044	1.12	.015	.38

For available colors and put-ups, see the on-line Belden Technical Data Sheet for the part number at www.belden.com

**UL AWM Style 1007, 1569 • CSA Type TR-64, TRSR-64
Dual-Rated Wire • 300 V, +80/+105 °C (UL) • 300 V, +90/+105 °C (CSA)**



- Tinned Copper Conductors
- PVC Insulation
- VW-1

Rated 600 V peak for electronic circuits, and internal wiring of electronic and electrical equipment

Part No.	AWG	Stranding	OD (Nom)		Insulation Thickness	
			Inch	mm	Inch	mm
9928	28	7 x 36	.047	1.19	.015	.38
9926	26	7 x 34	.051	1.30	.015	.38
9923	24	7 x 32	.056	1.42	.015	.38
9921	22	7 x 30	.062	1.57	.015	.38
9919	20	7 x 28	.069	1.75	.015	.38
9920	20	10 x 30	.067	1.70	.015	.38
9918	18	16 x 30	.079	2.01	.015	.38
9916	16	26 x 30	.092	2.34	.015	.38
9989*	14	41 x 30	.110	2.79	.015	.38

* Not AWM Style 1007.

For available colors and put-ups, see the on-line Belden Technical Data Sheet for the part number at www.belden.com

**UL AWM Style 1007 • CSA Type TR-64
300 V, +80 °C (UL) • 300 V, +90 °C (CSA)**



- Uni-Strand® Tinned Copper Conductors
- PVC Insulation
- VW-1

Recommended Maximum Baking Cycles: 24 Hours @ +300 °F (+149 °C)

Part No.	AWG	Stranding	OD (Nom)		Insulation Thickness	
			Inch	mm	Inch	mm
32822	22	7 x 30	.062	1.58	.015	.38
32820	20	7 x 28	.068	1.73	.015	.38

For available colors and put-ups, see the on-line Belden Technical Data Sheet for the part number at www.belden.com

PVC = Polyvinyl Chloride

PVC

**UL AWM Style 1015 or 1230 • CSA Type TEW
600 V, +105 °C (UL & CSA)**



- Tinned Copper Conductors
- PVC Insulation
- UL Type MTW (except 9924)
- VW-1

Rated 2500 V peak for electronic circuits, and internal wiring of electronic and electrical equipment

Part No.	AWG	Stranding	OD (Nom)		Insulation Thickness	
			Inch	mm	Inch	mm
9924	24	7 x 32	.088	2.24	.030	.76
8920	22	7 x 30	.093	2.36	.030	.76
8919	20	10 x 30	.100	2.54	.030	.76
8918	18	16 x 30	.110	2.79	.030	.76
8915	18	Solid	.105	2.67	.030	.76
8917	16	26 x 30	.123	3.12	.030	.76
8916	14	41 x 30	.138	3.51	.030	.76
9912	12	65 x 30	.158	4.01	.030	.76
9910	10	65 x 28	.180	4.57	.030	.76
8910	10	105 x 30	.186	4.72	.030	.76

For available colors and put-ups, see the on-line Belden Technical Data Sheet for the part number at www.belden.com

**UL AWM Style 1015 • CSA Type TEW
600 V, +105 °C (UL & CSA)**



- Uni-Strand Tinned Copper Conductors
- PVC Insulation
- VW-1

Recommended Maximum Baking Cycles: 48 Hours @ +275 °F (+135 °C), 24 Hours @ +300 °F (+149 °C)

Part No.	AWG	Stranding	OD (Nom)		Insulation Thickness	
			Inch	mm	Inch	mm
32722	22	7 x 30	.093	2.36	.030	.76
32720	20	7 x 28	.099	2.52	.030	.76
32718	18	7 x 26	.108	2.74	.032	.80

For available colors and put-ups, see the on-line Belden Technical Data Sheet for the part number at www.belden.com

**UL AWM Style 1015, 1028 • CSA Type TEW
600 V, +105 °C (UL & CSA)**



- Tinned Copper Conductors
- PVC Insulation
- UL Type MTW
- VW-1

Part No.	AWG	Stranding	OD (Nom)		Insulation Thickness	
			Inch	mm	Inch	mm
9908	8	84 x 27	.250	6.35	.045	1.14
8908	8	133 x 29	.262	6.65	.045	1.14

For available colors and put-ups, see the on-line Belden Technical Data Sheet for the part number at www.belden.com

PVC = Polyvinyl Chloride

PVC

**UL AWM Style 1015, 1283 • CSA Type TEW
600 V, +105 °C (UL & CSA)**



- Tinned Copper Conductors
- PVC Insulation
- UL Type MTW
- VW-1

PVC insulation hook-up wire for internal wiring of meters, panels, and electrical or electronic equipment

Part No.	AWG	Stranding	OD (Nom)		Insulation Thickness	
			Inch	mm	Inch	mm
9906	6	133 x 27	.331	8.41	.060	1.52
9904	4	133 x 25	.392	9.96	.060	1.52

For available colors and put-ups, see the on-line Belden Technical Data Sheet for the part number at www.belden.com

**Type MW, MIL-W-76C-PVC
1000 V, +80 °C (MIL)**



- Tinned Copper Conductors
- PVC Insulation, Medium Wall
- Flame and Ozone Resistant
- Inert to Most Chemicals, Oils, and Solvents

PVC insulation hook-up wire for internal wiring of meters, panels, and electrical or electronic equipment

Part No.	AWG	Stranding	OD (Nom)		Insulation Thickness	
			Inch	mm	Inch	mm
8538	24	Solid	.055	1.40	.017	.43
8525	24	7 x 32	.058	1.47	.017	.43
8530	22	Solid	.059	1.50	.017	.43
8524	22	7 x 30	.064	1.63	.017	.43
8529	20	Solid	.066	1.68	.017	.43
8523	20	10 x 30	.070	1.78	.017	.43
8522	18	16 x 30	.080	2.03	.017	.43
8521	16	26 x 30	.098	2.49	.019	.48
8520	14	41 x 30	.111	2.82	.018	.46
8527	12	65 x 30	.128	3.25	.018	.46

For available colors and put-ups, see the on-line Belden Technical Data Sheet for the part number at www.belden.com

**Type B, MIL-W-16878/1-PVC
600 V, +105 °C (MIL)**



- Tinned Copper Conductors
- PVC Insulation

PVC insulation hook-up wire for internal wiring of meters, panels, and electrical or electronic equipment

Part No.	AWG	Stranding	OD (Nom)		Insulation Thickness	
			Inch	mm	Inch	mm
8597	28	7 x 32	.035	.89	.010	.035
8505	26	7 x 34	.039	.89	.010	.035
8504	24	7 x 32	.044	1.12	.010	.035
8503	22	7 x 30	.050	1.27	.010	.035
8502	20	7 x 28	.058	1.47	.010	.035
8501	18	7 x 26	.068	1.73	.010	.035
8500	16	19 x 29	.079	2.01	.010	.035

For available colors and put-ups, see the on-line Belden Technical Data Sheet for the part number at www.belden.com

PVC = Polyvinyl Chloride

PVC Wire Dispenser Kits

Wire Dispenser Kits



- Tinned Copper Conductors
- PVC Insulation

Great for R & D labs, engineers, service personnel, and hobbyists

Part No.	No. of Spools	Wire Part No.	Temp Rating	AWG	Stranding	Spool Lengths	
						Feet	Meters
8816	8	8522	+80 °C	18	16 x 30	25	7.6
8824	8	8523	+80 °C	20	10 x 30		
8825	5	8502	+105 °C	20	7 x 28	100	30.4
9531	5	8524	+80 °C	22	7 x 30		
8800					Rack Only		

For available colors and put-ups, see the on-line Belden Technical Data Sheet for the part number at www.belden.com

GreenChoice™ PPO

UL AWM Style 11028
600 V, +105 °C



- Stranded Tinned Copper Conductors
- Zero Halogen Polyphenylene Oxide (PPO) Insulation
- VW-1
- -40 °C

Part No.	AWG	Stranding	OD (Nom)		Insulation Thickness	
			Inch	mm	Inch	mm
39128	28	7 x 36	.039	0.99	.012	0.30
39126	26	7 x 34	.043	1.09	.012	0.30
39124	24	7 x 32	.048	1.22	.012	0.30
39122	22	7 x 30	.053	1.35	.012	0.30
39120	20	10 x 30	.061	1.55	.012	0.30
39118	18	16 x 30	.069	1.75	.012	0.30
39116	16	26 x 30	.083	2.11	.012	0.30
39114	14	41 x 30	.097	2.46	.012	0.30
39112	12	65 x 30	.111	2.82	.012	0.30
39110	10	105 x 30	.144	3.66	.012	0.30

For available colors and put-ups, see the on-line Belden Technical Data Sheet for the part number at www.belden.com

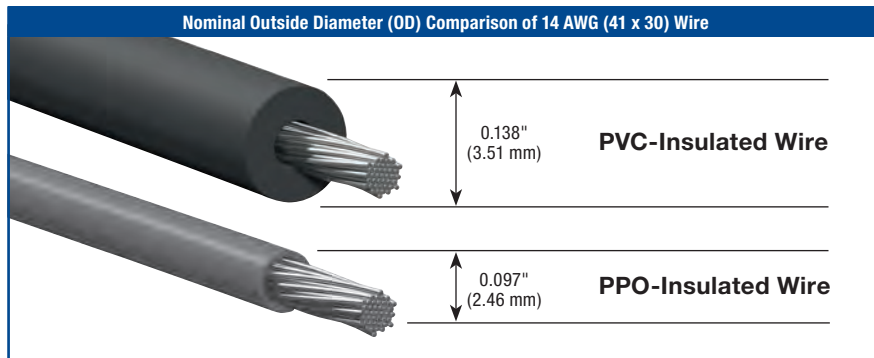

Polyphenylene oxide (PPO) insulation is nontoxic, nonpolluting, and recyclable. It has superior dielectric strength, and although it has thinner wall thickness than PVC, it provides a weight savings of up to 40%, 10 x better abrasion and pinch resistance, and a temperature rating of -40 °C to +105 °C.

PVC = Polyvinyl Chloride • PPO = Polyphenylene Oxide

TFE
High Temperature

UL AWM Style 1180 • Type EE, MIL-W-16878/5 TFE
300 V, +200 °C (UL) • 1000 V, +200 °C (MIL)



- Stranded Silver-Coated Conductors
- Extruded TFE Insulation
- VW-1

Part No.	AWG	Stranding	OD (Nom)		Insulation Thickness	
			Inch	mm	Inch	mm
83023*	24	19 x 36	.053	1.35	.015	.38
83025	22	7 x 30	.060	1.52	.015	.38
83026*	22	19 x 34	.059	1.50	.015	.38
83027*	20	19 x 32	.068	1.73	.015	.38
83028	20	7 x 28	.068	1.73	.015	.38
83029*	18	19 x 30	.077	1.96	.015	.38
83030*	16	19 x 29	.088	2.24	.015	.38

* Complies with MIL-W-16878 except stranding.
For available colors and put-ups, see the on-line Belden Technical Data Sheet for the part number at www.belden.com

UL AWM Style 1213 • Type E, MIL-W-16878/4 TFE
+105 °C (UL) • 600 V, +200 °C (MIL)



- Stranded Silver-Coated Conductors
- Extruded TFE Insulation
- VW-1

Part No.	AWG	Stranding	OD (Nom)		Insulation Thickness	
			Inch	mm	Inch	mm
83000	30	7 x 38	.032	.81	.010	.25
83001*	28	7 x 36	.035	.89	.010	.25
83002	26	7 x 34	.039	.99	.010	.25
83003*	24	19 x 36	.043	1.09	.010	.25
83004	24	7 x 32	.043	1.09	.010	.25
83005	22	7 x 30	.049	1.24	.010	.25
83006*	22	19 x 34	.048	1.22	.010	.25
83007*	20	19 x 32	.056	1.42	.010	.25
83008	20	7 x 28	.058	1.47	.010	.25

* Complies with MIL-W-16878 except stranding.
For available colors and put-ups, see the on-line Belden Technical Data Sheet for the part number at www.belden.com

TFE

High Temperature

**UL AWM Style 1371 • Type E, MIL-W-16878/4 TFE
+105 °C (UL) • 600 V, +200 °C (MIL)**



- Stranded Silver-Coated Copper Conductors
- Extruded TFE Insulation
- VW-1

Part No.	AWG	Stranding	OD (Nom)		Insulation Thickness	
			Inch	mm	Inch	mm
83009*	18	19 x 30	.068	1.73	.011	.28
83010*	16	19 x 29	.076	1.93	.012	.30

* Complies with MIL-W-16878 except stranding.
For available colors and put-ups, see the on-line Belden Technical Data Sheet for the part number at www.belden.com

**UL AWM Style 1371 • Type ET, MIL-W-16878/6 TFE
+105 °C (UL) • 250 V, +200 °C (MIL)**



- Stranded Silver-Coated Copper Conductors
- Extruded TFE Insulation
- VW-1

Part No.	AWG	Stranding	OD (Nom)		Insulation Thickness	
			Inch	mm	Inch	mm
83041	32	7 x 40	.022	.56	.006	.15
83043	30	7 x 38	.024	.61	.006	.15
83045	28	7 x 36	.027	.69	.006	.15
83046	26	7 x 34	.031	.79	.006	.15
83047	24	7 x 32	.036	.91	.006	.15
83048	24	19 x 36	.036	.91	.006	.15
83049	22	7 x 30	.042	1.07	.006	.15
83050	22	19 x 34	.042	1.07	.006	.15

For available colors and put-ups, see the on-line Belden Technical Data Sheet for the part number at www.belden.com

TFE = Tetrafluoroethylene

EPDM

High Temperature

UL AWM Style 3340, 3374**600 V, +125 °C Flex, +150 °C No Flex • CSA Type CL1254**

- Stranded Tinned Copper Conductors
- EPDM Insulation

Recommended for Class 130(B), 155(F) and also in some 180(H) systems
 Recommended maximum baking cycles: 24 hours @ +350 °F (+177 °C) • 4 hours @ +375 °F (+190 °C)

Part No.	AWG	Stranding	OD (Nom)		Insulation Thickness	
			Inch	mm	Inch	mm
37118	18	16 x 30	.142	3.61	.045	1.14
37116	16	26 x 30	.154	3.91	.045	1.14
37114	14	41 x 30	.169	4.29	.045	1.14
37112	12	65 x 30	.190	4.83	.045	1.14
37110	10	65 x 28	.240	6.10	.060	1.52
37108*	8	84 x 27	.327	8.31	.080	2.03
37106*	6	84 x 25	.383	9.73	.080	2.03
37104*	4	105 x 24	.432	10.97	.080	2.03
37103*	3	133 x 24	.453	11.51	.080	2.03
37102*	2	163 x 24	.494	12.55	.080	2.03
37101*	1	210 x 24	.583	14.81	.095	2.41
37190*	1/0	262 x 24	.633	16.08	.095	2.41
37100*	2/0	504 x 26	.698	17.73	.095	2.41
37130*	3/0	630 x 26	.758	19.25	.095	2.41
37140*	4/0	805 x 26	.849	21.57	.095	2.41

* Separator over conductor.

For available colors and put-ups, see the on-line Belden Technical Data Sheet for the part number at www.belden.com

EPDM

High Temperature

**UL AWM Style 3484 • CSA Type AWM
600 V, +125 °C**



- Stranded Tinned Copper Conductors
- EPDM Insulation
- Special Order

Part No.	AWG	Stranding	OD (Nom)		Insulation Thickness	
			Inch	mm	Inch	mm
37222	22	7 x 30	.093	2.36	.030	.76
37220	20	10 x 30	.102	2.59	.030	.76
37218	18	16 x 30	.109	2.77	.030	.76
37216	16	26 x 30	.123	3.12	.030	.76
37214	14	41 x 30	.138	3.51	.030	.76
37212	12	65 x 30	.158	4.01	.030	.76

For available colors and put-ups, see the on-line Belden Technical Data Sheet for the part number at www.belden.com

EPDM

High Voltage/High Temperature

**UL AWM Style 3499
7500 V, +150 °C**



- Stranded Tinned Copper Conductors
- EPDM Insulation
- Separator Over Conductor

Part No.	AWG	Stranding	OD (Nom)		Insulation Thickness	
			Inch	mm	Inch	mm
37508	8	84 x 27	.423	10.74	.125	3.18
37506	6	84 x 25	.470	11.94	.125	3.18
37504	4	105 x 24	.526	13.36	.125	3.18
37502	2	163 x 24	.581	14.76	.125	3.18
37501	1	210 x 24	.638	16.21	.125	3.18
37590	1/0	262 x 24	.688	17.48	.125	3.18
37500	2/0	504 x 26	.753	19.13	.125	3.18
37530	3/0	630 x 26	.813	20.65	.125	3.18
37540	4/0	805 x 26	.909	23.09	.125	3.18

Separator over conductor.

For available colors and put-ups, see the on-line Belden Technical Data Sheet for the part number at www.belden.com

EPDM = Ethylene-Propylene Diene Elastomer

XL-DUR®

XL-DUR insulation is a chemically cross-linked poly applied in a single extrusion, offering excellent thermal aging characteristics, moisture resistance, and solvent resistance. It provides an economic alternative to CSPE where extreme flexibility is not required. The insulation resists deformation when subjected to momentary high temperatures in customer assembly processes.

UL AWM Style 3199 • CSA Type CL1054 300 V, +105 °C



- Stranded Tinned Copper Conductors
- XL-DUR Insulation

Recommended maximum baking cycles: 24 hours @ +300 °F (+149 °C), 12 hours @ +325 °F (+163 °C), 8 hours @ +350 °F (+177 °C)

Part No.	AWG	Stranding	OD (Nom)		Insulation Thickness	
			Inch	mm	Inch	mm
35722	22	7 x 30	.062	1.58	.015	.38
35720	20	10 x 30	.073	1.85	.015	.38
35718	18	19 x 30.5	.078	1.98	.015	.38
35716	16	19 x 29	.091	2.31	.015	.38

For available colors and put-ups, see the on-line Belden Technical Data Sheet for the part number at www.belden.com

UL AWM Styles 3173, 3195, 3196 • CSA Type CL1251 600 V, +125 °C



- Stranded Tinned Copper Conductors
- XL-DUR Insulation

The 356 series is recommended for Class 130(B) as motor leads

Recommended maximum baking cycles: 24 hours @ +300 °F (+149 °C), 12 hours @ +325 °F (+163 °C), 8 hours @ +350 °F (+177 °C)

Part No.	AWG	Stranding	OD (Nom)		Insulation Thickness	
			Inch	mm	Inch	mm
UL AWM Style 3173						
35622	22	7 x 30	.093	2.36	.030	.76
35620	20	10 x 30	.101	2.57	.030	.76
35618	18	16 x 30	.109	2.77	.030	.76
35616	16	26 x 30	.122	3.10	.030	.76
35614	14	41 x 30	.137	3.48	.030	.76
35612	12	65 x 30	.153	3.89	.030	.76
35610	10	65 x 28	.177	4.50	.030	.76
UL AWM Style 3195 • Separator Over Conductor						
35608*	8	133 x 29	.263	6.68	.045	1.14
UL AWM Style 3196 • Separator Over Conductor						
35606*	6	133 x 27	.333	8.46	.060	1.52

* Separator over conductor.

For available colors and put-ups, see the on-line Belden Technical Data Sheet for the part number at www.belden.com

XL-DUR® (High-Temperature) and SIS (Switchboard) Wire

UL AWM Style 3436 and 3321 • CSA Type CL1251 •
CSA AWM • 600 V, +150 °C



- Stranded Tinned Copper Conductors
- XL-DUR Insulation

Part No.	AWG	Stranding	OD (Nom)		Insulation Thickness	
			Inch	mm	Inch	mm
35420	20	10 x 30	.102	2.59	.030	.76
35418	18	16 x 30	.110	2.79	.030	.76
35416	16	26 x 30	.123	3.12	.030	.76
35414	14	41 x 30	.138	3.51	.030	.76
35412	12	65 x 30	.153	3.89	.030	.76
35410	10	65 x 28	.177	4.50	.030	.76

For available colors and put-ups, see the on-line Belden Technical Data Sheet for the part number at www.belden.com

UL Type SIS
600 V, +150 °C



- Stranded Tinned Copper Conductors
- XL-DUR Insulation
- VW-1 only on 31014, 31012, 31010
- Separator Over Conductor

Part No.	AWG	Stranding	OD (Nom)		Insulation Thickness	
			Inch	mm	Inch	mm
31014	14	41 x 30	.144	3.66	.030	.76
31012	12	65 x 30	.167	4.24	.030	.76
31010	10	65 x 28	.184	4.67	.030	.76
31014N	14	41 x 30	.144	3.66	.030	.76
31012N	12	65 x 30	.167	4.24	.030	.76
31010N	10	65 x 28	.184	4.67	.030	.76
31008N	8	133 x 29	.268	6.75	.045	1.14

Separator over conductor.

For available colors and put-ups, see the on-line Belden Technical Data Sheet for the part number at www.belden.com

Chlorosulfonated Polyethylene

Chlorosulfonated polyethylene insulation has excellent heat resistance, color stability and electrical properties. CSPE is recommended for motor leads for Class 130(B) insulation systems. It may be considered as an alternative to silicone rubber to withstand +155 °C varnish baking temperatures, but is not suitable for operating temperatures above Class 130(B).

UL AWM Style 3191, 3192, 3193 CSA Type CL1053 (18–12 AWG), CL1052 (10–4/0 AWG) 600 V, +105 °C • 300 V, +105 °C (CL1052)



- Stranded Tinned Copper Conductors
- CSPE Insulation
- Separator Over Conductor (8 AWG & larger)

Recommended maximum baking cycles: 24 hours @ +300 °F (+149 °C)

Part No.	AWG	Stranding	OD (Nom)		Insulation Thickness	
			Inch	mm	Inch	mm
UL AWM Style 3191 (600 V, +105 °C) • CSA Type CL1053						
34418	18	16 x 30	.142	3.61	.045	1.14
34416	16	26 x 30	1.55	3.94	.045	1.14
34414	14	41 x 30	1.70	4.32	.045	1.14
34412	12	65 x 30	1.90	4.83	.045	1.14
UL AWM Style 3191 • CSA Type CL1052**						
34410	10	65 x 28	.209	5.31	.045	1.14
UL AWM Style 3192 • CSA Type CL1052**						
34408*	8	84 x 27	.290	7.37	.060	1.52
34406*	6	84 x 25	.343	8.71	.060	1.52
34404*	4	105 x 24	.399	10.14	.060	1.52
34403*	3	133 x 24	.420	10.69	.060	1.52
34402*	2	163 x 24	.445	11.53	.060	1.52
UL AWM Style 3193 • CSA Type CL1052**						
34401*	1	210 x 24	.557	14.15	.080	2.03
34490*	1/0	262 x 24	.607	15.42	.080	2.03
34400*	2/0	504 x 26	.668	16.97	.080	2.03
34430	3/0	630 x 26	.732	18.59	.080	2.03
34440	4/0	805 x 26	.819	20.80	.080	2.03

* Separator over conductor.

** CSA requires additional wall thickness in sizes 10 AWG and larger to meet CL1053 requirements.

For available colors and put-ups, see the on-line Belden Technical Data Sheet for the part number at www.belden.com

UL AWM Style 3190 • CSA Type CL1052 300 V, +105 °C (UL & CSA)



- Stranded Tinned Copper Conductors
- CSPE Insulation

Part No.	AWG	Stranding	OD (Nom)		Insulation Thickness	
			Inch	mm	Inch	mm
34922	22	7 x 30	.093	2.36	.030	.76
34920	20	10 x 30	.100	2.54	.030	.76
34918	18	16 x 30	.110	2.79	.030	.76
34916	16	26 x 30	.123	3.12	.030	.76
34914	14	41 x 30	.138	3.51	.030	.76

For available colors and put-ups, see the on-line Belden Technical Data Sheet for the part number at www.belden.com

CSPE = Chlorosulfonated Polyethylene

Chlorosulfonated Polyethylene

5000 V High Voltage



- Stranded Tinned Copper Conductors
- CSPE Insulation
- Separator Over Conductor

Part No.	AWG	Stranding	OD (Nom)		Insulation Thickness	
			Inch	mm	Inch	mm
36108	8	84 x 27	.480	12.19	.150	3.81
36106	6	84 x 25	.532	13.51	.150	3.81
36104	4	105 x 24	.588	14.94	.150	3.81
36102	2	163 x 24	.643	16.33	.150	3.81
36101	1	210 x 24	.700	17.78	.150	3.81
36190	1/0	262 x 24	.750	19.05	.150	3.81
36100	2/0	504 x 26	.815	20.70	.150	3.81
36140	4/0	805 x 26	.959	24.36	.150	3.81

Separator over conductor.

For available colors and put-ups, see the on-line Belden Technical Data Sheet for the part number at www.belden.com

Neoprene

UL AWM Style 3044 • CSA Type CL902 300 V, +90 °C (UL & CSA)



- Stranded Tinned Copper Conductors
- Neoprene Insulation

Recommended maximum baking cycles: 24 hours @ +300 °F (+149 °C), 8 hours @ +325 °F (+163 °C), 15 minutes @ +450 °F (+232 °C)

Part No.	AWG	Stranding	OD (Nom)		Insulation Thickness	
			Inch	mm	Inch	mm
31520	20	10 x 30	.100	2.54	.030	.76
31518	18	16 x 30	.109	2.77	.030	.76
31516	16	26 x 30	.122	3.10	.030	.76

For available colors and put-ups, see the on-line Belden Technical Data Sheet for the part number at www.belden.com

UL AWM Style 3046, 3048 • CSA Type CL903 600 V, +90 °C (UL & CSA)



- Stranded Tinned Copper Conductors
- Neoprene Insulation
- Separator Over Conductor (8 AWG and Larger)

Part No.	AWG	Stranding	OD (Nom)		Insulation Thickness	
			Inch	mm	Inch	mm
UL AWM Style 3046 • CSA Type CL903						
32518	18	16 x 30	.142	3.61	.045	1.14
32516	16	26 x 30	.155	3.94	.045	1.14
31514	14	41 x 30	.169	4.29	.045	1.14
31512	12	65 x 30	.190	4.83	.045	1.14
UL AWM Style 3046						
31510	10	65 x 28	.209	5.31	.045	1.14
UL AWM Style 3048						
31508	8	84 x 27	.285	7.24	.060	1.52
31506	6	84 x 25	.343	8.71	.060	1.52
31504	4	105 x 24	.399	10.14	.060	1.52
31502	2	163 x 24	.454	11.53	.060	1.52

For available colors and put-ups, see the on-line Belden Technical Data Sheet for the part number at www.belden.com

Silicone Rubber
Braidless

UL AWM Styles 3212, 3213, 3214 • CSA Type AWM
600 V, +150 °C (UL & CSA)



- Stranded Tinned Copper Conductors
- Silicone Rubber Insulation
- Separator Over Conductor (8 AWG and Larger)
- Easy and Clean Stripping
- Excellent Physical and Mechanical Strength

Recommended for applications requiring Class 155(F) or Class 180(H) materials and high-temperature applications in motors, lighting fixtures, clothes dryers, stoves, therapeutic and electronic devices.
Recommended maximum baking cycles: 24 hours @ +410 °F (+210 °C)

Part No.	AWG	Stranding	OD (Nom)		Insulation Thickness	
			Inch	mm	Inch	mm
UL AWM Style 3212 • CSA Type AWM						
33322**	22	7 x 30	.125	3.18	.045	1.14
33320**	20	10 x 30	.132	3.53	.045	1.14
33318	18	16 x 30	.142	3.61	.045	1.14
33316	16	26 x 30	.155	3.94	.045	1.14
33314	14	41 x 30	.170	4.32	.045	1.14
33312	12	65 x 30	.190	4.83	.045	1.14
33310	10	65 x 28	.209	5.31	.045	1.14
UL AWM Style 3213 • CSA Type AWM						
33308*	8	84 x 27	.283	7.19	.060	1.52
33306*	6	84 x 25	.334	8.48	.060	1.52
33304*	4	105 x 24	.390	9.91	.060	1.52
33302*	2	163 x 24	.457	11.61	.060	1.52
UL AWM Style 3214 • CSA Type AWM						
33390*	1/0	262 x 24	.594	15.09	.080	2.03

* Separator over conductor.

** Special Order Only.

For available colors and put-ups, see the on-line Belden Technical Data Sheet for the part number at www.belden.com

UL AWM Style 3135
600 V, +200 °C (UL)



- Stranded Tinned Copper Conductors
- Silicone Rubber Insulation
- Special Order Only

The 334 Series is for use only in totally enclosed systems.
Recommended maximum baking cycles: 24 hours @ +410 °F (+210 °C)

Part No.	AWG	Stranding	OD (Nom)		Insulation Thickness	
			Inch	mm	Inch	mm
33418	18	7 x 26	.111	2.82	.030	.76
33416	16	7 x 24	.123	3.12	.030	.76
33414	14	7 x 22	.139	3.53	.030	.76

For available colors and put-ups, see the on-line Belden Technical Data Sheet for the part number at www.belden.com

Silicone Rubber

Glass Braid

UL AWM Styles 3069, 3070, 3101 • CSA Type SEWF-2 600 V, +150 °C (UL & CSA)



- Stranded Tinned Copper Conductors
- Glass Braided Silicone Rubber Insulation
- VW-1

Recommended maximum baking cycles: 24 hours @ +410 °F (+210 °C)

Part No.	AWG	Stranding	OD (Nom)		Insulation Thickness		
			Inch	mm	Inch	mm	
UL AWM Style 3069 • CSA Type SEWF-2							
30820	20	10 x 30	.122	3.10	.030	.76	
UL AWM Style 3070 • CSA Type SEWF-2							
30818	18	16 x 30	.132	3.35	.030	.76	
30816	16	26 x 30	.145	3.68	.030	.76	
30814	14	41 x 30	.164	4.17	.030	.76	
30812	12	65 x 30	.186	4.72	.030	.76	
UL AWM Style 3101 • CSA Type SEWF-2							
30810	10	65 x 28	.239	6.07	.045	1.14	

For available colors and put-ups, see the on-line Belden Technical Data Sheet for the part number at www.belden.com

UL AWM Styles 3071, 3074, 3075, 3125, 3126 • CSA Type SEW-2 600 V, +200 °C (UL & CSA)



- Stranded Tinned Copper Conductors
- Glass Braided Silicone Rubber Insulation
- Separator Over Conductors (8 AWG and Larger)
- VW-1
- Glass Braid Provides Additional Abrasion Resistance and Is Treated to Prevent Fraying

Recommended for high-temperature applications in motors, lighting fixtures, clothes dryers, stoves, therapeutic and electronic devices. These wires can be used with Class 130(B), 155(F) or 180(H) insulation systems. Recommended maximum baking cycles: 24 hours @ +410 °F (+210 °C)

Part No.	AWG	Stranding	OD (Nom)		Insulation Thickness		
			Inch	mm	Inch	mm	
UL AWM Style 3071 • CSA Type SEW-2							
32418	18	7 x 26	.133	3.38	.030	.76	
32416	16	7 x 24	.145	3.68	.030	.76	
32414	14	7 x 22	.167	4.24	.030	.76	
UL AWM Style 3074 • CSA Type SEW-2							
32412	12	19 x 24.5	.190	4.83	.030	.76	
UL AWM Style 3075 • CSA Type SEW-2							
32410	10	19 x 22.5	.238	6.05	.045	1.14	
UL AWM Style 3125 • CSA Type SEW-2							
30808	8	54 x 25	.313	7.95	.060	1.52	
30806	6	84 x 25	.368	9.35	.060	1.52	
30804	4	105 x 24	.424	10.77	.060	1.52	
30802	2	163 x 24	.496	12.60	.060	1.52	
UL AWM Style 3126 • CSA Type SEW-2							
30801	1	210 x 24	.622	15.80	.080	2.03	
30890	1/0	262 x 24	.670	17.02	.080	2.03	
30800	2/0	504 x 26	.727	18.47	.080	2.03	
30830	3/0	630 x 26	.795	20.19	.080	2.03	
30840	4/0	266 x 21	.779	19.79	.080	2.03	

For available colors and put-ups, see the on-line Belden Technical Data Sheet for the part number at www.belden.com

Mercury Switch

UL AWM Style 3123 Mercury Switch • 600 V, +150 °C (UL)



- Stranded Tinned Copper Conductors
- Silicone Rubber Insulation

Part No.	AWG	Stranding	OD (Nom)		Insulation Thickness	
			Inch	mm	Inch	mm
34020	20	105 x 40	.110	2.79	.030	.76
34017	17	210 x 40	.118	3.00	.030	.76

For available colors and put-ups, see the on-line Belden Technical Data Sheet for the part number at www.belden.com

High-Voltage Leads



- Stranded Tinned Copper Conductors
- Polyethylene Insulation
- PVC Jacket, Red or Black
- Conductive Polyethylene (Korona-Guard) Over Inner Conductor Provides Uniform Distribution of Voltage Stresses
- +80 °C

Part No.	AWG	Stranding	OD (Nom)		Insulation Thickness		Suggested Working Voltage (VDC)	Breakdown Voltage (VDC)
			Inch	mm	Inch	mm		
8868	22	7 x 30	.150	3.81	.044	1.12	24,000	48,000
8869	22	7 x 30	.120	3.05	.027	.69	17,000	35,000
9867*	20	7 x 28	.191	4.85	.046	1.17	30,000	60,000
8866	18	16 x 30	.208	5.28	.057	1.45	40,000	80,000

* UL AWM Style 3239 (30,000 V DC, +80 °C), VW-1.

For available colors and put-ups, see the on-line Belden Technical Data Sheet for the part number at www.belden.com

Test Prod Wire



- Stranded Tinned Copper Conductors

Part No.	AWG	Stranding	OD (Nom)		Insulation Thickness		Suggested Working Voltage (VDC)	Breakdown Voltage (VDC)
			Inch	mm	Inch	mm		
5000 V, +90 °C • Rubber Insulation								
8899	18	65 x 36	.144	3.66	.045	1.14	5000	20,000
5000 V, +80 °C • Rubber Insulation • Manufactured for MIL-W-13169B								
8897	18	65 x 36	.144	3.66	.045	1.14	5000	20,000
5000 V, +80 °C • PVC Insulation • UL AWM Style 1855								
9899	18	65 x 36	.144	3.66	.048	1.22	5000	—
10,000 V, +90 °C • Rubber Insulation								
8898	18	65 x 36	.229	5.82	.088	2.24	10,000	29,000
1000 V, +90 °C • Rubber Insulation • Miniature Cable								
8890	24	45 x 40	.066	1.68	.019	.48	1000	10,000

For available colors and put-ups, see the on-line Belden Technical Data Sheet for the part number at www.belden.com

PVC = Polyvinyl Chloride

Magnet Wire

Class 200 • One Pound Spool



- Bare Copper Conductor
- Cross-Linked Polyester Base Coat
- Amide-imide Polymer Top Coat
- +200 °C
- LJ-W-1177/14
- MW 35-C (Heavy) or MW 74-C (Heavy)

Class 200 magnet wire offers exceptional ability to resist solvents and abuse in difficult windings

Part No.	AWG (Solid)	Approximate Length		Turns per Linear Inch	Turns per Square Inch
		Feet	Meters		
8085*	38	19,300	5882.7	206.0	42,436
8083	34	7860	2395.8	133.1	17,716
8081	30	3140	957.1	86.2	7430
8080	28	1990	606.6	69.4	4816
8079	26	1260	384.1	55.7	3102
8078	24	793	241.7	44.7	1998
8077	22	501	152.7	36.0	1296
8076	20	315	96.0	28.9	835
8075	18	199	60.7	23.2	538
8074	16	126	38.4	18.6	346
8073	14	80	24.4	14.9	222

For available colors and put-ups, see the on-line Belden Technical Data Sheet for the part number at www.belden.com

Single Beldsol™ Solderable • Half Pound Spool



- Bare Copper Conductor
- Polyurethane Base Coat
- Nylon Top Coat
- J-W-1177/9
- MW 28-C (Single)
- Rated by IEEE Tests for +270 °F Usage
- Solders without Insulation Removal at +750 °F
- Solvent Resistant

Part No.	AWG (Solid)	Approximate Length		Turns per Linear Inch	Turns per Square Inch
		Feet	Meters		
8058	36	6400	1950.7	180.0	32,400
8057	34	4060	1237.5	144.0	20,736
8056	32	2515	766.6	114.0	12,996
8055	30	1615	492.3	91.7	8409
8054	28	1020	310.9	73.8	5446
8053	26	645	196.6	59.0	3481
8052	24	404	123.1	46.9	2200
8051	22	254	77.4	37.5	1406
8050	20	160	48.8	29.9	894
8049	18	100	30.5	23.9	571

For available colors and put-ups, see the on-line Belden Technical Data Sheet for the part number at www.belden.com

Shielding and Bonding Cable, Direct Burial Cable, Bus Bar, and Antenna Wire

Shielding and Bonding Cable

- Braided Tinned Copper



Part No.	AWG	Stranding	Approximate Circular Area		Nominal ID Tubular		Recommended Max. Current (Amps)
			CMA	mm ²	Inch	mm	
8660	14.3	96 x 34	3800	1.92	.125	3.18	27.0
8668	13.3	120 x 34	4800	2.43	.172	4.37	36.0
8663	11.9	168 x 34	6700	3.40	.219	5.56	38.0
8661	11.3	192 x 34	7600	3.85	.203	5.16	46.0
8669	8.9	336 x 34	13300	6.74	.500	12.70	62.0
8662	6.6	576 x 34	22900	11.60	.781	19.84	80.0
8670	3.4	480 x 30	48000	24.32	.750 Flat Width	19.05 Flat Width	145.0

Note: Dimensions and wire gauge shown are approximate, due to pliable nature of braided cables.
For available colors and put-ups, see the on-line Belden Technical Data Sheet for the part number at www.belden.com

Direct Burial



- Stranded Tinned Copper Conductors
- High-Density Polyethylene Insulation, Black

Part No.	AWG	Stranding	OD (Nom)		Insulation Thickness		Suggested Working Voltage (VDC)
			Inch	mm	Inch	mm	
9438	14	104 x 34	.139	3.53	.032	.81	600

For available colors and put-ups, see the on-line Belden Technical Data Sheet for the part number at www.belden.com

Bus Bar Wire



- Solid Tinned Copper Conductors
- QQ-W-343G
- QQ-W-343S_S1T (on request)

Part No.	AWG	OD (Nom)		Circular Area	
		Inch	mm	CMA	mm ²
8025	30	.010	.26	102	.05
8024	28	.013	.33	164	.08
8023	26	.016	.41	262	.13
8022	24	.021	.52	424	.22
8021	22	.026	.65	650	.33
8020	20	.033	.83	1056	.54
8019	18	.041	1.03	1648	.84
8013	16	.052	1.31	2673	1.35
8012	14	.065	1.66	4251	2.15
8011	12	.083	2.11	6872	3.48

For available colors and put-ups, see the on-line Belden Technical Data Sheet for the part number at www.belden.com

Antenna Wire

- Stranded Copper-Covered Steel



Part No.	AWG	Stranding	OD (Nom)	
			Inch	mm
8000	14	7 x 22	.076	1.93

For available colors and put-ups, see the on-line Belden Technical Data Sheet for the part number at www.belden.com

Technical Information

Conductor and Insulation Materials

Tough Cables for Tough Environments

The technical information provided in this section has been expanded to include additional graphs and supplementary data as an aid in specifying the hook-up and lead wire best suited to the needs of a particular application. If you require additional technical information, contact Belden Technical Support at 1-800-BELDEN1.

The tables on the following pages are offered as a guide to assist users in selecting the correct lead wire for their application.

Conductors

Uni-Strand®

Uni-Strand tinned copper conductor. In this type of construction, the bare copper wires are stranded, then tinned to coat the strands and also to fill in the interstices between strands. This allows for easier wire stripping with no re-twisting operation.

Insulation Materials

PVC

Vinyl plastic insulation is fast stripping, and resists oil, solvents, and ozone. The colors are bright and remain distinct after processing. Applications include motors, transformers, fluorescent ballasts and fixtures, switchboards, panels, controls, rectifiers and electronic circuits. Meets VW-1 Vertical Wire Flame Test in many cases.

TFE

TFE is a fluorinated thermoplastic with outstanding thermal, physical, and electrical properties. TFE is generally restricted to applications requiring its special characteristics because its basic resin and processing costs are relatively high.

Belden Teflon wire products are highly recommended for miniature cable applications because of their superior thermal and electrical properties. Teflon is especially suitable for internal wiring-soldering applications where insulation meltback is a specific problem. Belden wiring products insulated with Teflon are outstanding in their resistance to oil, oxidation, heat, sunlight and flame; and also in their ability to remain flexible at low temperatures. They have excellent resistance to ozone, water, alcohol, gasoline, acids, alkalis, aromatic hydrocarbons and solvents.

EPDM

EPDM (ethylene-propylene diene monomer) is a chemically cross-linked elastomer with excellent flexibility at high and low temperatures (+150 °C to -60 °C). It has good insulation and dielectric strength, as well as excellent abrasion resistance and mechanical properties. EPDM also has better cut-through resistance than silicone rubber, which it replaces in some applications.

EPDM is compatible with most varnishes. After the dip and bake cycle, however, the varnish tends to adhere to the insulation because EPDM, unlike some rubber insulations, does not exude oils or waxes.

As the lead wires are pulled apart for termination or flexed, the varnish cracks, sometimes tearing the insulation.

To help this problem, a stearic solution is applied to the lead wire during the manufacturing process. However, many varnishes may still bond to the insulation unless other special coatings are applied. (Other slip coats are available at additional cost.) Because most cleaning processes will remove these coatings from the EPDM lead wire, cleaning EPDM lead wire before using in the process is not recommended.

Due to the above, it is recommended that the compatibility between the individual lead wire size, the bake/varnish process and varnish used always be checked and, if possible, do not allow any varnish to extend beyond a point where the lead wire will be flexed or bent.

XL-DUR®

XL-DUR is a lead wire insulation using thermoset, chemically XLP. Because of its excellent physical and electrical properties, XL-DUR is highly desirable for a wide variety of applications.

CSPE

Chlorosulfonated polyethylene insulation has excellent heat resistance, color stability and electrical properties.

Neoprene

Neoprene insulation has good heat aging characteristics and is an excellent motor lead wire. It may be considered for use in hazardous locations and is being used in explosion-proof motors recognized by UL.

Silicone Rubber

Braidless silicone lead wire features easy and clean stripping without the problems associated with glass braid lead wire. It has excellent physical and mechanical strength properties. It is recommended for high-temperature applications in motors, lighting fixtures, clothes dryers, stoves, therapeutic, and electronic devices. Varnish compatibility should be checked before production. Some rigid varnishes may cause cracking when the wire is severely bent.

Silicone Rubber – Glass Braid

The silicone insulation strips clean and easy. The glass braid provides additional abrasion resistance and is treated to prevent fraying. Recommended for high-temperature applications in motors, lighting fixtures, clothes dryers, stoves, therapeutic and electronic devices.

PPO

Polyphenylene oxide (PPO) has superior dielectric properties to enable a thinner wall thickness and an outside diameter that is up to 45% smaller and significantly lighter than conventional PVC-insulated wire. PPO-based wires offer the same electrical properties as PVC wires with a voltage rating of 600 V. Strong and flexible, PPO offers 10x the abrasion and pinch resistance of PVC. In addition, PPO insulation contains no halogens, phthalates, or heavy metals, allowing it to be burned or easily recycled.

Technical Information

Insulation Characteristics and Color Codes

How to Use

The choice of an appropriate conductor, with respect to current carrying capacity, usually depends on one or more factors which vary according to application. These factors include the temperature in which the lead wire operates, temperature rise of equipment, limitations of insulation, voltage drop, and location of wires as in free air or enclosed, such as formed by a compartment, tubing, or a bundle of wires.

For these reasons it is not practical to provide a general chart showing the current carrying capacity of lead wire for all conditions. Accordingly, the values shown in Table 3 are MAXIMUM for a single conductor in free air, based on ambient temperature of +30 °C. For actual use temperatures above an ambient temperature of +30 °C, reduce the maximum ampacity by use of correction factor in Table 5 to correct the values in Table 3 and Table 4.

Table 1: Insulation Characteristics

Insulation	Temperature Rating, °C	UL Voltage Rating (Volts)	Oil Resistance	Ozone Resistance	Abrasion	Flame Resistance
Neoprene	90	300/600	Good	Good	Good	Good
PVC	80	300	Good-Excellent	Good-Excellent	Good	Excellent
	105	600	Good-Excellent	Good-Excellent	Good	Excellent
CSPE	105	300/600	Good	Excellent	Good	Good
PPO	105	600	—	—	—	—
	105	300	Good	Good	Excellent	Fair-Good
XL-DUR® XLP	125	600	Good	Good	Excellent	Fair-Good
	150	600	Good	Good	Excellent	Fair-Good
EPDM	125	600	Fair-Poor	Good	Good	Fair
	150	600	Fair-Poor	Good	Good	Fair
Silicone Rubber	150	300	Fair	Good	Poor	Good
	200	600	Fair	Good	Poor	Good
Silicone Rubber Glass Braid	150	600	Fair	Excellent	Excellent	Good
	200	600	Fair	Excellent	Excellent	Good
TFE	150	300	Excellent	Excellent	Excellent	Excellent
	200	300	Excellent	Excellent	Excellent	Excellent
	260	300	Excellent	Excellent	Excellent	Excellent

For available colors and put-ups, see the on-line Belden Technical Data Sheet for the part number at www.belden.com

Table 2: Lead Wire Color Chart

Color No.	Color Combination	Color No.	Color Combination	Color No.	Color Combination
1	Brown	13	Dark Blue	25	White/Black/Yellow
2	Red	14	White/Black	26	White/Black/Blue
3	Orange	15	White/Red	27	White/Black/Brown
4	Yellow	16	White/Green	28	White/Black/Orange
5	Green	17	White/Yellow	29	White/Black/Gray
6	Light Blue	18	White/Blue	30	White/Black/Purple
7	Purple	19	White/Brown	189	Green/Yellow
8	Gray	20	White/Orange	620	Green/min 30% Yellow
9	White	21	White/Gray	876	Nickel Gray
10	Black	22	White/Purple	B02	Purple
11	Tan	23	White/Black/Red	—	—
12	Pink	24	White/Black/Green	—	—

For available colors and put-ups, see the on-line Belden Technical Data Sheet for the part number at www.belden.com

Technical Information
Current Carrying Capacity

Table 3: Lead Wire Current Carrying Capacity

AWG	+90 °C Neoprene, SIS	+105 °C Vinyl, GSPE, PPO	+125 °C XL-DUR®	+150 °C EPDM, XL-DUR®, Silicone	+200 °C Silicone
22	10	11	12	14	16
20	13	14	15	18	21
18	18	20	22	24	28
16	24	26	28	31	35
14	35	39	42	46	54
12	40	51	55	60	68
10	55	67	72	80	90
8	80	90	97	106	124
6	105	121	131	155	165
4	140	160	172	190	220
3	165	180	194	214	252
2	190	215	232	255	293
1	220	247	266	293	344
1/0	260	286	309	339	399
2/0	300	329	355	390	467
3/0	350	380	410	451	546
4/0	405	446	481	529	629

Values (amperes) shown in this table are maximum for a single conductor in free air with an assumed ambient room temperature of +30 °C (+86 °F). For available colors and put-ups, see the on-line Belden Technical Data Sheet for the part number at www.belden.com

Table 4: Current Carrying Capacity of 2 or 3 Conductors

AWG	+90 °C Neoprene, SIS	+105 °C Vinyl, GSPE, PPO	+125 °C XL-DUR	+150 °C EPDM, XL-DUR, Silicone	+200 °C Silicone
22	6	7	8	9	10
20	8	9	10	10	15
18	14	15	16	17	20
16	18	19	20	22	25
14	25	29	31	34	36
12	30	36	39	43	45
10	40	46	50	55	60
8	55	64	69	76	83
6	75	81	87	96	110
4	95	109	118	120	125
3	110	129	139	143	152
2	130	143	154	160	171
1	150	168	181	186	197
1/0	170	193	208	215	229
2/0	195	229	247	251	260
3/0	225	263	284	288	297
4/0	260	301	325	332	346

Current carrying capacity of not more than three (3) conductors in a raceway, conduit or cable. The values (amperes) shown in this table are maximum at an assumed ambient room temperature of +30 °C (+86 °F). For available colors and put-ups, see the on-line Belden Technical Data Sheet for the part number at www.belden.com

Technical Information
Current Carrying Capacity

Table 5: Correction Factors for Tables 3 & 4

Ambient Temperature (°C)	Insulation Temperature Rating				
	+90 °C	+105 °C	+125 °C	+150 °C	+200 °C
31-35	.96	1.00	1.00	1.00	1.00
36-40	.91	1.00	1.00	1.00	1.00
41-45	.87	.93	.94	.95	.97
46-50	.82	.93	.94	.95	.97
51-55	.76	.85	.87	.90	.94
56-60	.71	.85	.87	.90	.94
61-70	.58	.76	.880	.85	.90
71-80	.41	.65	.73	.80	.87
81-90	—	.53	.64	.74	.83
91-100	—	.38	.54	.67	.79
101-120	—	—	.24	.52	.71
121-140	—	—	—	.30	.61
141-160	—	—	—	—	.50
161-180	—	—	—	—	.35
2/0	195	229	247	251	260
3/0	225	263	284	288	297
4/0	260	301	325	332	346

For ambient temperatures over +30 °C, multiply the ampacities shown in Table 3 or Table 4 by the appropriate correction factor to determine the maximum allowable load current. For available colors and put-ups, see the on-line Belden Technical Data Sheet for the part number at www.belden.com

Correction Factors for Table 4

Number of Conductors	Reduction Percentage	Number of Conductors	Reduction Percentage
4 thru 6	80%	21 thru 30	45%
7 thru 9	70%	31 thru 40	40%
10 thru 20	50%	41 and above	35%

For ambient temperatures over +30 °C, multiply the ampacities shown in Table 3 or Table 4 by the appropriate correction factor to determine the maximum allowable load current. For available colors and put-ups, see the on-line Belden Technical Data Sheet for the part number at www.belden.com

Technical Information

Temperature Classifications

Conductor Configurations

Table 6: Nominal Temperature Operating Ranges (°C)

-100 °C	-80 °C	-60 °C	-40 °C	-20 °C	0 °C	100 °C	20 °C	40 °C	60 °C	80 °C	100 °C	120 °C	140 °C	160 °C	180 °C	200 °C	220 °C	240 °C		
				-30 °C	Neoprene						+90 °C									
				-30 °C	CSPE						+105 °C									
				-40 °C	PPO						+105 °C									
				-60 °C	EPDM						+105 °C									
				-75 °C	Silicone Braidless												+200 °C			
				-75 °C	Silicone Braided												+200 °C			
				-60 °C	XLP						+105 °C									
				-35 °C	PVC						+105 °C									
				-100 °C	TFE														+260 °C	

Table 7: Temperature Classification

Insulation System Class	Minimum Acceptable Lead Wire Temperature Rating	
	°C	°F
130 (B)	+90	+194
155 (F)	+125	+257
180 (H)	+150	+302
220 (R)	+200	+392

Systems of Insulating Materials – UL Standard 1446.

This is a guide intended for UL approved insulation systems connected to branch circuits of 600 V or less.

Approval required by Underwriters Laboratories when using lead wire with a temperature rating more than +5 °C under the system temperature rating.

For available colors and put-ups, see the on-line Belden Technical Data Sheet for the part number at www.belden.com

Table 8: Conductor Configurations

Typical Application	American Wire Gage							
	12	14	16	18	20	22	24	26
Fixed Services Hook-Up Wire Cable in Raceway	19 x 25	Solid or 19 x 27	Solid or 19 x 29	Solid or 7 x 26 or 16 x 30	Solid or 7 x 28 or 10 x 30	Solid or 7 x 30	Solid or 7 x 32	Solid or 7 x 34
Fixed Services Hook-Up Wire Frequently Disturbed For Maintenance	65 x 30	19 x 27 or 41 x 30	19 x 29 or 26 x 30	16 x 30 or 41 x 34	7 x 28, 10 x 30, 19 x 32, or 26 x 34	7 x 30 or 19 x 34	7 x 34 or 10 x 34	7 x 34
Severe Flexing Microphone Test Products	165 x 34	104 x 34	65 x 34 or 104 x 36	41 x 34 or 65 x 36	26 x 34 or 42 x 36	19 x 34 or 26 x 36	19 x 36 or 45 x 40	7 x 34 or 10 x 36
Most Severe Duty Mercury Switches	259 x 36 (7 x 37 Rope Lay)*	168 x 36 (7 x 24 Rope Lay)*	105 x 36 (7 x 15 Rope Lay)*	63 x 36 (7 x 9 Rope Lay)*	105 x 40 (3 x 35 Rope Lay)*	(Consider Braid or Tinsel)		

Note: For a given AWG wire size (based on equal cross-sectional area of conductor), limpness and flex life are increased by use of a large number of fine strands. The finer stranding does result in higher costs. * Rope Lay is several stranded groups cabled together. For example: 12 AWG, 259 x 36 is 7 cords each consisting of 37 strands of 36 AWG.

For available colors and put-ups, see the on-line Belden Technical Data Sheet for the part number at www.belden.com

Technical Information

Packaging



Drums

Conductor is available in three drum pack sizes:

- The #15 Beldpak® is 15" high and 23" in diameter.
- The #31 Beldpak is 30.5" high and 23" in diameter.
- The #42 Beldpak (pictured) is 42" high and 23" in diameter.
- Price and delivery information is available upon request.

Packaging: Drums

OD of Wire		#15 Beldpak		#31 Beldpak		#42 Beldpak	
Inch	mm	1000	km	1000	km	1000	km
.070	1.78	35	10.7	70	21.3	85	25.9
.080	2.03	27	8.2	55	16.8	70	21.3
.090	2.29	21	6.4	43	13.1	55	16.8
.100	2.54	17	5.2	35	10.7	48	14.6
.110	2.79	12	3.7	25	7.6	40	12.2
.120	3.05	10	3.0	20	6.1	34	10.4
.130	3.30	9	2.7	18	5.5	30	9.1
.140	3.56	8	2.4	15	4.6	20	6.1
.150	3.81	7	2.1	14	4.3	18	5.5
.160	4.06	6	1.8	12	3.7	16	4.9
.170	4.32	5	1.5	10	3.0	14	4.3

For available colors and put-ups, see the on-line Belden Technical Data Sheet for the part number at www.belden.com



Reels

Reel dimensions will vary by size, determined by AWG of wire.

Special Orders

Orders for special packages must be placed for footage mentioned or for multiples for these quantities per color.

Packaging: Spools

OD of Wire		Quantity		Crate Reels	Head Diameter		Barrel Diameter		Height Transverse	
Inch	mm	1000'	km		Inch	mm	Inch	mm	Inch	mm
.080	2.03	10.0	3.05	1748	15-3/4	400	8	203	8	203
.090	2.29	8.0	2.24	1748	15-3/4	400	8	203	8	203
.100	2.54	6.5	1.98	1748	15-3/4	400	8	203	8	203
.110	2.79	5.0	1.52	1748	15-3/4	400	8	203	8	203
.120	3.05	6.0	1.83	1747	15-3/4	400	8	203	10-1/2	267
.130	3.30	5.0	1.52	1747	15-3/4	400	8	203	10-1/2	267
.140	3.56	6.0	1.83	1746	17-3/4	451	8	203	10-1/2	267
.150	3.81	5.0	1.52	1746	17-3/4	451	8	203	10-1/2	267
.160	4.06	4.5	1.37	1746	17-3/4	451	8	203	10-1/2	267
.170	4.32	7.0	2.13	1744	22	559	10	254	14-1/4	362
.180	4.57	6.0	1.83	1744	22	559	10	254	14-1/4	362
.190	4.83	5.5	1.68	1744	22	559	10	254	14-1/4	362
.200	5.08	5.0	1.52	1744	22	559	10	254	14-1/4	362
.250	6.35	5.0	1.52	1743	26	660	10	254	14-1/4	362
.300	7.62	3.5	1.07	1743	26	660	10	254	14-1/4	362
.350	8.89	2.5	.76	1743	26	660	10	254	14-1/4	362
.400	10.16	2.0	.61	1743	26	660	10	254	14-1/4	362
.450	11.43	1.5	.46	1743	26	660	10	254	14-1/4	362
.500	12.70	1.2	.37	1743	26	660	10	254	14-1/4	362
.550	13.97	1.0	.31	1743	26	660	10	254	14-1/4	362
.600	15.24	1.2	.37	1733	30	762	10	254	14-1/4	362

Crate Reel numbers are Belden's internal numbers. They are representative only to the extent of the dimensions shown. Weight of the wire may require another reel with dimensions identical to those shown. For available colors and put-ups, see the on-line Belden Technical Data Sheet for the part number at www.belden.com

Conductors

Solid Copper Wire, American Wire Gage

Gage (AWG)	Nominal OD		Nominal Circular MIL Area	Nominal Weight (Inch per 1000')	Nominal Resistance @ +68 °F (Ω/1000')
	Inches	mm			
10	.1019	2.60	10380.0	31.43	.9989
11	.0907	2.30	8234.0	24.92	1.260
12	.0808	2.05	6530.0	19.77	1.588
13	.0720	1.83	5178.0	15.68	2.003
14	.0641	1.63	4107.0	12.43	2.525
15	.0571	1.45	3260.0	9.858	3.184
16	.0508	1.29	2583.0	7.818	4.016
17	.0453	1.15	2050.0	6.200	5.064
18	.0403	1.02	1620.0	4.917	6.385
19	.0359	.912	1200.0	3.899	8.051
20	.0320	.813	1020.0	3.092	10.15
21	.0285	.724	812.1	2.452	12.80
22	.0253	.643	640.4	1.945	16.14
23	.0226	.574	511.5	1.542	20.36
24	.0201	.511	404.0	1.223	25.67
25	.0179	.455	320.4	.9699	32.37
26	.0159	.404	253.0	.7692	40.81
27	.0142	.361	201.5	.6100	51.47
28	.0126	.320	159.8	.4837	64.90
29	.0113	.287	126.7	.3836	81.83
30	.0100	.254	100.5	.3042	103.2
31	.0089	.226	79.7	.2413	130.1
32	.0080	.203	63.21	.1913	164.1
33	.0071	.180	50.13	.1517	206.9
34	.0063	.160	39.75	.1203	260.9
35	.0056	.142	31.52	.09542	331.0
36	.0050	.127	25.00	.07568	414.8
37	.0045	.114	19.83	.0613	512.1

Information from National Bureau of Standards Copper Wire Tables – Handbook 100.

Unparalleled Performance Belden is one of only a very few cable manufacturers to draw and anneal its own conductors. This is a time-consuming process, but it allows us to ensure signal integrity, as well as proper physical characteristics.

In addition, the standards under which we design and manufacture our fiber optic cabling are among the strictest in the industry. The result is a comprehensive offering of products which give unparalleled performance and can satisfy your most demanding operating and environmental challenges.

For available colors and put-ups, see the on-line Belden Technical Data Sheet for the part number at www.belden.com



Power & Control Portable Cordage

Section Table of Contents

Power & Control	Page
Portable Cordage	
Overview	188
Introduction	189
2-Conductor	190–191
3-Conductor	192–193
4-, 5- and Multi-Conductor	194
UL Cordage Types: Designation, Construction and Rating	195



Portable Cordage



Belden portable cordage products are available in a wide assortment of styles, lengths and thicknesses. Products offered include 2, 3, 4 and 5-conductor, as well as multi-conductor constructions.

Jacket options include PVC, Rubber, Oil-resistant Rubber and Belflex®. Belflex is a premium PVC jacket compound (Class 43) that is superior to standard PVC for flexibility and durability.

Product Features

- Temperature range up to +105 °C (Belflex®)
- UL/CSA approvals
- Paper tape or cotton serve separator or conductor polarity
- Shielded and unshielded options
- Jacket material PVC, Rubber, Oil-resistant Rubber, Belflex®

Benefits

Belden portable cordage is listed by Underwriters Laboratories Inc. (UL). This approval signifies that UL has approved all elements of the cordage as meeting their applicable construction and performance standards. Certain Belden portable cordage products are certified to CSA (Canadian) standards.

Applications

Belden's portable cordage portfolio can be used for power in a wide range of applications, from operating motors to power extensions, home appliances and machinery.

Can be used in:

- Building management systems
- Industrial applications
- Audio applications



Introduction

Manufacturer's Identification

Identification of the flexible cord is provided by our UL and CSA file numbers or printed name on the cord jacket.

UL/CSA File Numbers

- UL: E-3462
- CSA: LL-7874

Portable Cordage Packaging

Belden's unique UnReel® cable dispenser is available for many of the portable cordage products listed in this section.

Color Code Comparison by Function

Color Coding		Function
International	North American Standards	
Light Blue	White	N-Neutral
Brown	Black	L-Live
Green/Yellow	Green or Green/Yellow	E-Earth or Ground

2-Conductor

UL/CSA Types: SPT -1, SPT -2, SP-1, HPN

Parallel Cordage



Part No.	AWG	Stranding	OD (Nom)		Insulation Thickness	
			Inch	mm	Inch	mm

Type SPT-1 • PVC Insulation • 300 V, +60 °C • Parallel Lamp Cord

BC Conductors • Brown, Black, White, or Silver Insulation • UL/CSA Listed • One Conductor Polarity Ribbed						
19122	18	42 x 34	.110 x .207	2.79 x 5.26	.032	.81
8888*	18	42 x 34	.110 x .207	2.79 x 5.26	.032	.81

Type SPT-2 • PVC Insulation • 300 V, +60 °C • Parallel Lamp Cord

BC Conductors • Brown or Black Insulation • UL/CSA Listed • One Conductor Polarity Ribbed						
19123	18	42 x 34	.144 x .277	3.66 x 7.04	.049	1.24
19126	16	65 x 34	.155 x .299	3.94 x 7.59	.048	1.22

Type SP-1 • Rubber Insulation • 300 V, +60 °C • Parallel Lamp Cord

BC Conductors • Black Insulation • UL Listed • One Conductor Polarity Ribbed						
19115	18	41 x 34	.123 x .227	3.12 x 5.77	.035	.89

Type HPN • CPE Insulation • 300 V, +90 °C • Parallel Heater Cord

BC Conductors • Black Insulation • UL/CSA Listed						
19405	18	41 x 34	.140 x 2.76	3.56 x 7.01	.047	1.18
19404	16	105 x 36	.152 x .300	3.86 x 7.62	.047	1.18

* Not CSA listed

2-Conductor

UL/CSA Types: SJ, SJO, SJTOW, SO, STOW, SV, SVT



Part No.	AWG	Stranding	OD (Nom)		Insulation Thickness		Jacket Thickness	
			Inch	mm	Inch	mm	Inch	mm

Type SJ • Rubber Jacket • 300 V, +60 °C

BC Conductors • Paper Tape Separator • Smooth Black Jacket • UL/CSA Listed • Conductor Color Code: Black, White								
8478	18	42 x 34	.290	7.37	.032	.81	.035	.89
8472	16	65 x 34	.315	8.00	.033	.84	.035	.89

Type SJO • Oil-Resistant Rubber Jacket • 300 V, +90 °C

BC Conductors • Paper Tape Separator • Smooth Matte Black Jacket • UL/CSA Listed • Conductor Color Code: Black, White								
19227	18	16 x 30	.290	7.37	.031	.79	.035	.89
19228	16	26 x 30	.315	8.00	.031	.79	.035	.89

Type SJTOW • Belflex® Premium PVC Jacket • 300 V, +105 °C

BC Conductors • Paper Tape Separator • Smooth Matte Black Jacket • UL/CSA Listed • VW-1 • International Conductor Color Code: Light Blue, Brown								
19506	18	42 x 34	.290	7.37	.032	.81	.035	.89
19507	16	65 x 34	.319	8.10	.033	.84	.037	.94
19508	14	41 x 30	.348	8.84	.033	.84	.032	.81

Type SO • Oil-Resistant Rubber Jacket • 600 V, +90 °C

BC Conductors • Smooth Black Jacket • Cotton Server Separator or Paper Tape (12 AWG Only) • UL/CSA Listed • Conductor Color Code: Black, White								
19204	18	42 x 34	.360	9.14	.032	.81	.065	1.65
19203	16	65 x 34	.385	9.78	.033	.84	.065	1.65
19202	14	41 x 30	.523	13.28	.048	1.22	.085	2.16
19201	12	65 x 30	.610	15.49	.051	1.30	1.00	2.54

Type STOW • Belflex Premium PVC Jacket • 600 V, +105 °C

BC Conductors • Paper Tape Separator • Smooth Black Jacket • UL/CSA Listed • VW-1 • International Conductor Color Code: Light Blue, Brown								
19500	18	42 x 34	.360	9.14	.032	.81	.070	1.78
19501	16	65 x 34	.386	9.80	.033	.84	.070	1.78
19502	14	41 x 30	.524	13.31	.049	1.24	.089	2.26

Type SV • Rubber Jacket • 300 V, +60 °C • Serrated Jacket

BC Conductors • Cotton Serve Separator • Serrated Black Jacket • UL/CSA Listed • Conductor Color Code: Black, White								
8452	18	42 x 34	.245	6.22	.017	.43	.037	.94

Type SV • Rubber Jacket • 300 V, +60 °C • Smooth Jacket

BC Conductors • Cotton Serve Separator • Smooth Black Jacket • UL/CSA Listed • Conductor Color Code: Black, White								
19120	18	42 x 34	.245	6.22	.017	.43	.037	.94

Type SVT • PVC Jacket • 300 V, +60 °C

BC Conductors • Paper Tape Separator • Serrated Black Jacket • UL/CSA Listed • Conductor Color Code: Black, White								
19140	18	42 x 34	.243	6.17	.018	.46	.036	.91

BC = Bare Copper • PVC = Polyvinyl Chloride

3-Conductor

UL/CSA Types: S, SO, SJ, SJO, SJT



Part No.	AWG	Stranding	OD (Nom)		Insulation Thickness		Jacket Thickness	
			Inch	mm	Inch	mm	Inch	mm

Type S • Rubber Jacket • 600 V, +60 °C

BC Conductors • Cotton Serve (18 – 16 AWG) or Paper Tape (14 – 10 AWG) Separator • Smooth Black Jacket • UL/CSA Listed • Conductor Color Code: Black, White, Green								
19109	18	42 x 34	.380	9.65	.032	.81	.065	1.65
19108	16	65 x 34	.405	10.29	.033	.84	.065	1.65
19107	14	41 x 30	.535	13.59	.048	1.22	.085	2.16
19106	12	65 x 30	.640	16.26	.051	1.30	.099	2.51
19105	10	105 x 30	.681	17.30	.050	1.27	.099	2.51

Type SO • Oil-Resistant Rubber Jacket • 600 V, +90 °C

BC Conductors • Cotton Serve (18 – 16 AWG) or Paper Tape (14 – 10 AWG) Separator • Smooth Black Jacket • UL/CSA Listed • Conductor Color Code: Black, White, Green								
19209	18	42 x 34	.380	9.65	.032	.81	.065	1.65
19208	16	65 x 34	.400	10.16	.033	.84	.063	1.60
19207	14	41 x 30	.538	13.67	.048	1.22	.086	2.18
19206	12	65 x 30	.632	16.05	.051	1.30	.100	2.54
19205	10	105 x 30	.681	17.30	.050	1.27	.099	2.51

Type SJ • Rubber Jacket • 300 V, +60 °C

BC Conductors • Paper Tape Separator • Smooth Black Jacket • UL/CSA Listed • Conductor Color Code: Black, White, Green								
19129	18	16 x 30	.315	8.00	.031	.79	.039	.99
19125	18	42 x 34	.315	8.00	.032	.81	.038	.97
19130	16	26 x 30	.340	8.64	.031	.79	.038	.97
19124	16	65 x 34	.340	8.64	.033	.84	.038	.97
8479	14	41 x 30	.380	9.65	.031	.79	.039	.99

Type SJO • Oil-Resistant Rubber Jacket • 300 V, +90 °C

BC Conductors • Smooth Black Jacket • Paper Tape Separator • UL/CSA Listed • Conductor Color Code: Black, White								
19229	18	16 x 30	.315	8.00	.031	.79	.039	.99
19230	16	26 x 30	.340	8.64	.031	.79	.038	.97

Type SJT • PVC Jacket • 300 V, +60 °C

BC Conductors • Paper Tape Separator • Serrated Black or Gray Jacket • UL/CSA Listed • Conductor Color Code: Black, White, Green (18 AWG) or Green/Yellow (16 AWG)								
19348	18	42 x 34	.328	8.33	.032	.81	.046	1.17
19349	16	65 x 34	.340	8.84	.033	.84	.038	.97

Type SJT • PVC Jacket • 300 V, +60 °C • International Conductor Color Code

BC Conductors • Paper Tape Separator • Smooth Black or Brown Jacket • UL/CSA Listed • Conductor Color Code: Light Brown, Blue, Green/Yellow								
19352	18	42 x 34	.328	8.33	.032	.81	.046	1.17
19353	16	65 x 34	.353	8.97	.033	.84	.036	.91
19354	14	41 x 30	.380	9.65	.033	.84	.038	.97

BC = Bare Copper • PVC = Polyvinyl Chloride

3-Conductor

UL/CSA Types: SJT, SJTOW, STOW, SV, SVT



Part No.	AWG	Stranding	OD (Nom)		Insulation Thickness		Jacket Thickness	
			Inch	mm	Inch	mm	Inch	mm

Type SJT • PVC Jacket • Shielded • 300 V, +60 °C • International Conductor Color Code

BC Conductors • Beldfoil® Shield • Smooth Black Jacket • UL/CSA Listed • Conductor Color Code: Light Blue, Brown, Green/Yellow								
19362	18	42 x 34	.340	8.64	.032	.81	.050	1.27
19363	16	65 x 34	.365	9.27	.033	.84	.047	1.19
19364	14	41 x 30	.402	10.21	.033	.84	.042	1.07

Type SJT • PVC Jacket • Low Leakage • 300 V, +75 °C

BC Conductors • Paper Tape Separator • Smooth Brown Jacket • UL Listed • Conductor Color Code: Black, White, Green								
9998	16	65 x 34	.475	12.07	.033	.84	.045	1.14

Type SJTOW • Belflex® Premium PVC Jacket • 300 V, +105 °C • International Conductor Color Code

BC Conductors • Paper Tape Separator • Smooth Matte Black Jacket • UL/CSA Listed • VW1 • Conductor Color Code: Light Blue, Brown, Green/Yellow								
19509	18	42 x 34	.315	8.00	.032	.81	.038	.97
19510	16	65 x 34	.340	8.64	.033	.84	.038	.97
19511	14	41 x 30	.380	9.65	.032	.81	.040	1.02

Type STOW • Belflex® Premium PVC Jacket • 600 V, +105 °C • International Conductor Color Code

BC Conductors • Paper Tape Separator • Smooth Black Matte Jacket • UL/CSA Listed • VW1 • Conductor Color Code: Light Blue, Brown, Green/Yellow								
19503	18	42 x 34	.380	9.65	.032	.81	.070	1.78
19504	16	65 x 34	.405	10.29	.033	.84	.070	1.78
19505	14	41 x 30	.558	14.17	.049	1.24	.089	2.26

Type SV • Rubber Jacket • 300 V, +60 °C

TC Conductors • Cotton Serve Separator • Smooth Black Jacket • UL/CSA Listed • Conductor Color Code: Black, White, Green								
8453	18	41 x 34	.256	6.50	.018	.46	.036	.91

Type SVT • PVC Jacket • 300 V, +60 °C

BC Conductors • Paper Tape Separator • Serrated Gray Jacket • UL/CSA Listed • Conductor Color Code: Black, White, Green								
19350	18	42 x 34	.253	6.43	.018	.46	.038	.97

Type SVT • PVC Jacket • 300 V, +60 °C • International Conductor Code

BC Conductors • Paper Tape Separator • Smooth Black Jacket • UL/CSA Listed • Conductor Color Code: Light Blue, Brown, Green/Yellow								
19402	18	42 x 34	.253	6.43	.018	.46	.034	.86

Type SVT • PVC Jacket • Shielded • 300 V, +60 °C • International Conductor Color Codes

BC Conductors • Beldfoil® Shield • 22 AWG (7 x 30) Drain Wire • Smooth Black Jacket • UL/CSA Listed • Conductor Color Code: Light Blue, Brown, Green/Yellow								
19401	18	42 x 34	.270	6.86	.018	.46	.043	1.09

Type SVT • PVC Jacket • Shielded • 300 V, +60 °C • International Conductor Color Codes

BC Conductors • Duofoil® Shield (100% Coverage) • Braid (88% Coverage) Smooth Black Jacket • UL/CSA Listed • Conductor Code: Light Blue, Brown, Green/Yellow								
19403	18	42 x 34	.307	7.80	.018	.46	.038	.97

BC = Bare Copper • TC = Tinned Copper • PVC = Polyvinyl Chloride

4-, 5-, and Multi-Conductor

UL/CSA Type SO and UL AWM Styles 4097 and 4256



4-Conductor

Part No.	AWG	Stranding	OD (Nom)		Insulation Thickness		Jacket Thickness	
			Inch	mm	Inch	mm	Inch	mm

AWM Style 4097 • Rubber Jacket • 300 V, +60 °C

TC Conductors • Paper Tape Separator • Smooth Black Jacket • Conductor Color Code: Black, White, Brown, Red								
8454	18	41 X 34	.265	6.73	.018	.46	.036	.91

Type SO • Oil-Resistant Rubber Jacket • 600 V, +90 °C

BC Conductors • Paper Tape Separator • Smooth Black Jacket • UL/CSA Listed • Conductor Color Code: Black, White, Green, Red								
19217	14	41 x 30	.603	15.32	.048	1.22	.087	2.21
19216	12	65 x 30	.690	17.53	.051	1.30	.102	2.59

5-Conductor

Part No.	AWG	Stranding	OD (Nom)		Insulation Thickness		Jacket Thickness	
			Inch	mm	Inch	mm	Inch	mm

AWM Style 4256 • Rubber Jacket • 300 V, +60 °C

TC Conductors • Paper Tape Separator • Smooth Black Jacket • Conductor Color Code: Brown, Green, White, Black, Red								
8455	20 (3)	26 x 34	.280	7.11	.018	.46	.031	.79
	18 (2)	41 x 34						

Multi-Conductor

Part No.	Conductors	AWG	Stranding	OD (Nom)		Insulation Thickness		Jacket Thickness	
				Inch	mm	Inch	mm	Inch	mm

Type SO • 4256 • Oil-Resistant Rubber Jacket • 600 V, +60 °C

BC Conductors • Paper Tape Separator • Smooth Black Jacket • UL/CSA Listed • Conductor Color Code: Chart 2									
9420	5	16	65 x 34	.506	12.85	.033	.84	.084	2.13
9422	7	16	65 x 34	.581	14.76	.033	.84	.083	2.11
9424	9	16	65 x 34	.720	18.29	.033	.84	.100	2.54
9425	12	16	65 x 34	.720	28.29	.033	.84	.100	2.54
9427	16	16	65 x 34	.787	19.99	.033	.84	.100	2.54
9429	20	16	65 x 34	.862	21.89	.033	.84	.100	2.54

BC = Bare Copper • TC = Tinned Copper | Belden Color Code Charts can be found at page 344.

UL Cordage Type

Designation, Construction and Rating

Cord Type*	Description	AWG Size Range	No. of Cond.	Conductor Insulation Material and Min. Average Thickness (inches/millimeters)	Jacket Material and Min. Average Thickness** (inches/millimeters)	Temperature Rating (°C)†		Voltage Rating
						Standard	Other	
HPN	Heater Parallel Neoprene	18-12	2 or 3††	.045"/1.14 mm Rubber	—	90	105	300
HSJ	Heater Service Junior	18-12	2, 3, 4	.030"/0.76 mm Rubber††	.030"/0.76 mm Rubber	90	—	300
HSJO	HSJO with Oil-Resistant Jacket	18-12	2, 3, 4	.030"/0.76 mm Rubber ▲	.030"/0.76 mm Rubber	90	—	300
S	Service	18-2	2 or more	.030"/0.76 mm Rubber ▲	.060"/1.52 mm Rubbers	60	75, 90	600
SE	Service Elastomer	18-2	2 or more	.030"/0.76 mm Elastomer	.060"/1.52 mm Elastomer	105	—	600
SEO	SE with Oil-Resistant Jacket	18-2	2 or more	.030"/0.76 mm Elastomer	.060"/1.52 mm Elastomer	105	—	600
SJ	Service Junior	18-10	2, 3, 4, 5	.030"/0.76 mm Rubber	.030"/0.76 mm Rubber	60	75, 90	300
SJE	Service Junior Elastomer	18-10	2, 3, 4, 5	.030"/0.76 mm Elastomer††	.030"/0.76 mm Elastomer	105	—	300
SJEO	SJE with Oil-Resistant Jacket	18-10	2, 3, 4, 5	.030"/0.76 mm Elastomer	.030"/0.76 mm Elastomer	105	—	300
SJO	SJ with Oil-Resistant Jacket	18-10	2, 3, 4, 5	.030"/0.76 mm Rubber ♦	.030"/0.76 mm Rubber	60	75, 90, 105	300
SJT	Service Junior Thermoplastic	18-10	2, 3, 4, 5	.030"/0.76 mm Plastic ♦	.030"/0.76 mm Plastic	60	75, 90, 105	300
SJTO	SJT with Oil-Resistant Jacket	18-10	2, 3, 4, 5	.030"/0.76 mm Plastic ♦	.030"/0.76 mm Plastic	60	75, 90, 105	300
SO	Service with Oil-Resistant Jacket	18-2	2 or more	.030"/0.76 mm Rubber ▲	.060"/1.52 mm Rubber	60	75, 90	600
SP-1	Service Parallel, 1/32" Insulation	18	2 or 3††	.030"/0.76 mm Rubber	—	60	—	300
SP-2	Service Parallel, 3/64" Insulation	18-16	2 or 3††	.045"/1.14 mm Rubber	—	60	—	300
SP-3	Service Parallel, 1/16" Insulation	18-12	2 or 3††	.060"/1.52 mm Rubber ▲	—	60	—	300
SPT-1	Service Thermoplastic, 1/32" Insulation	18	2 or 3††	.030"/0.76 mm Plastic	—	60	75, 90, 105	300
SPT-2	Service Thermoplastic, 3/64" Insulation	18-16	2 or 3††	.045"/1.14 mm Plastic	—	60	75, 90, 105	300
SPT-3	Service Thermoplastic, 1/16" Insulation	18-10	2 or 3††	.060"/1.52 mm Plastic ▲	—	60	75, 90, 105	300
ST	Service Thermoplastic	18-2	2 or more	.030"/0.76 mm Plastic ▲	.060"/1.52 mm Plastics	60	75, 90, 105	600
STO	ST with Oil-Resistant Jacket	18-2	2 or more	.030"/0.76 mm Plastic ▲	.060"/1.52 mm Plastics	60	75, 90, 105	600
SV	Service Vacuum	18	2 or 3††	.015"/0.38 mm Rubber	.030"/0.76 mm Rubber	60	75, 90	300
SVE	Service Vacuum Elastomer	18-17	2 or 3††	.015"/0.38 mm Elastomer	.030"/0.76 mm Elastomer	105	—	300
SVEO	SVE with Oil-Resistant Jacket	18-17	2 or 3††	.015"/0.38 mm Elastomer	.030"/0.76 mm Elastomer	105	—	300
SVO	SVO with Oil-Resistant Jacket	18	2 or 3††	.015"/0.38 mm Rubber	.030"/0.76 mm Rubber	60	75, 90	300
SVT	Service Vacuum Thermoplastic	18-17	2 or 3††	.015"/0.38 mm Plastic	.030"/0.76 mm Plastic	60	75, 90, 105	300
SVTO	SVT with Oil-Resistant Jacket	18-17	2 or 3††	.015"/0.38 mm Plastic	.030"/0.76 mm Plastic	60	75, 90, 105	300
TPT	Tinsel Parallel Thermoplastic	27 (Tinsel)	2	.030"/0.76 mm Plastic	—	60	—	300
TST	Tinsel Service Thermoplastic	27 (Tinsel)	2	.015"/0.38 mm Plastic	.030"/0.76 mm Rubber	60	—	300

* Types SVO, SVTO, SJO, SJTO, SO, STO and HSJO have jackets which are also recognized for oil resistance at maximum temperature of 60°C. Types SJ, SJO, SJT, SJTO, S, SO, ST and STO may also be made for outdoor use and will be indicated by adding a "W" suffix to the cord type. Similarly, types SJ, SJTO, SJO, SJT, S, SO, ST and STO may also be made in water-resistant grades with "Water-Resistant" printed on the jacket. 3-wire SJT may be made in special low-leakage constructions for medical equipment cords.

** Where no jacket is shown, the construction is integral or flat style with insulation also serving as jacket.

† For cordage ratings higher than 60°C, the temperature limit is printed on the outside of the jacket. This does not apply to heater cordage type HPN, rated 90°C, or 105°C.

†† Recognized in three conductors when third or center conductor (with Green or Green/Yellow stripe) is used for equipment grounding.

▲ Insulation and jacket thickness depend on cordage size. Thickness as shown are for 18 and 16 AWG.

♦ Insulation and jacket thickness depend on cordage size.

No. 12 AWG requires .030" conductor insulation thickness and .045" jacket thickness.

No. 10 AWG requires .045" conductor insulation thickness and .060" jacket thickness.

The term Elastomer refers to thermoplastic elastomer.



Enjoy the benefits of
our experience and
innovations.



Data Communication Systems Computer Cables



Section Table of Contents

Data Communication Systems	Page
Computer Cables	
Overview	198
Multi-Conductor Computer Cables	199
Computer Cables for RS-232 Applications	199–200
Computer Cables for RS-232, RS-423, and IEEE 488	201
Low-Capacitance Computer Cables for RS-232 Applications	202
Low-Capacitance Computer Cables for RS-232 and RS-423 Applications	203
Paired Computer Cables	204
Computer Cables for RS-232 Applications	204–205
Low-Capacitance Computer Cables for RS-232 and RS-422 Applications	206
Low-Capacitance 100 Ohm Computer Cables for RS-422 and Digital Audio Applications	207–208
Low-Capacitance Computer Cables for RS-232 Applications	209
Low-Capacitance Computer Cables for RS-232 and RS-422 Applications	210–211
Low-Capacitance Computer Cables for RS-232, RS-422, and RS-485 Applications	212
Low-Capacitance Computer Cables for RS-485 Applications	213
Computer POS Cables	214
Low-Capacitance Computer Cables for RS-232, RS-422 and Digital Audio Applications	215

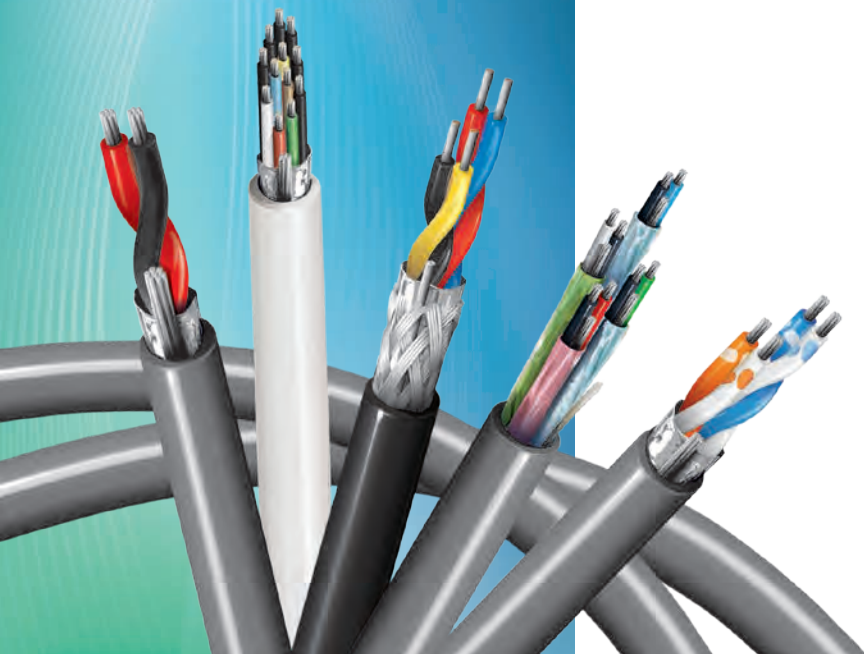

Computer Cables



Belden Computer cables are manufactured in a wide variety of gauge (AWG) sizes, insulation materials, shielding configurations, and jacking materials including Plenum versions. These cables meet the technical requirements of many different applications, with proven reliability and performance that is best in class.

Product Features

- Broad range of AWG sizes, shielding options, conductor (designs include up to 50 wires) and pair counts (up to 50)
- EMI/RFI protective foil and braid designs, such as Beldfoil®, to reduce such interferences
- PVC, LSZH, FEP, Natural Flamearrest and Fluorocopolymer jackets
- UL, AWM and IEC ratings
- MSHA approved designs

Benefits

Higher Level of Safety through:

- Certified fire-resistant characteristics preventing spreading of fire and ensuring the safety of the building
- Single and bundle flame test against flame propagation
- Limited smoke release minimizing safety hazards

Lifetime Performance:

- 10 year warranty

Unmatched Signal Performance through:

- Patented Beldfoil® shielding technology for maximum EMI and cross talk protection
- Lower Electrical capacitance ensuring system performance
- A constant performance during temperature variations ranging between -30 °C up to +90 °C without signal disruptions
- UL certified design quality

Applications

Computer cables are designed but are not limited to RS-232, RS-422/423, RS-488 & RS-485 applications, as Computer & CAD/CAM and Low speed data communication from microprocessor to device utilizing simple commands (On, Off, Stop, Start).

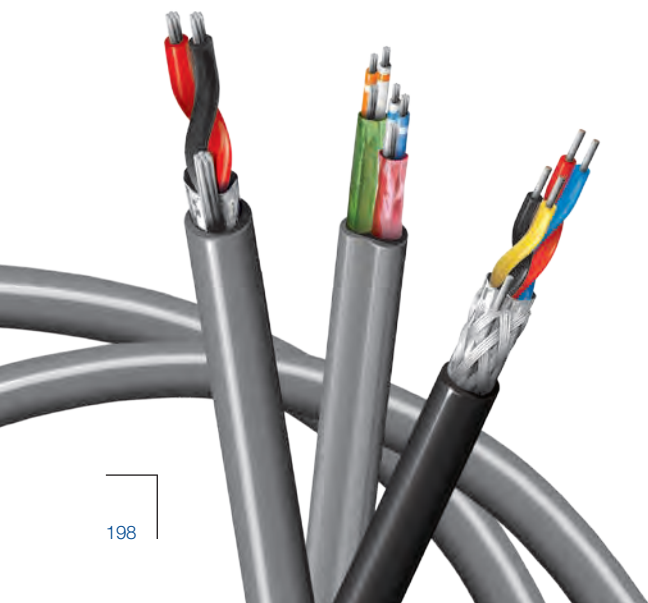

Multi-Conductor Computer Cables
Computer Cables for RS-232 Applications

300 V, +80 °C • Foil Shield



24 AWG • SR-PVC/PVC

- AWM Style
- NEC: CMG
- CEC: CMG FT4

24 AWG • PE/LSZH

- Flame IEC 60332-3-24
- Smoke IEC 6103

Part No.	Conductors	Color Code	OD (Nom)		Insulation Thickness		Jacket Thickness		Capacitance*	
			Inch	mm	Inch	mm	Inch	mm	pF/Ft	pF/m

24 AWG • SR-PVC/PVC

Stranded (7 x 32) TC Conductors • Semi-Rigid PVC Insulation • Cabled • Overall Beldfoil® Shield • 28 AWG Stranded TC Drain Wire • Chrome PVC Jacket										
9533	3	Chart 1	.162	4.11						
9534	4	Chart 1	.184	4.67						
9535	5	Chart 1	.189	4.80	.011	.28	.032	.81	65	213
9536	6	Chart 1	.209	5.31						
9537	7	Chart 1	.209	5.31						
9538	8	Chart 1	.224	5.69						
9539	9	Chart 1	.244	6.20						
9540	10	Chart 1	.244	6.20						
9541	15	Chart 2R	.284	7.21	.011	.28	.032	.81		
9542	20	Chart 2R	.314	7.98					55	180
9543	25	Chart 2R	.339	8.61						
9544	30	Chart 2R	.380	9.65	.011	.28	.040	1.02		
9545	40	Chart 2R	.406	10.31						
9546	50	Chart 2R	.490	12.45	.011	.28	.045	1.14		

24 AWG • PE/LSZH

Stranded (7 x 32) TC Conductors • PE Insulation • Cabled • Overall Beldfoil® Shielding • 28 AWG Stranded TC Drain Wire • Chrome LSZH Jacket										
9534NH	30	Chart 1	.190	4.85						
9536NH	40	Chart 1	.220	5.48	.011	.28	.035	.90	65	213
9541NH	50	Chart 2R	.290	7.40			.031	.80	55	180

* One conductor to other conductors connected to shield.

TC = Tinned Copper • PVC = Polyvinyl Chloride | Belden Color Code Charts can be found at page 344.

Multi-Conductor Computer Cables

Computer Cables for RS-232 Applications

300 V, +80 °C • Foil/Braid Shield



- AWM Style
- VW-1

- NEC: CMG
- CEC: CMG FT4

Part No.	Conductors	Color Code	OD (Nom)		Insulation Thickness		Jacket Thickness		Capacitance*	
			Inch	mm	Inch	mm	Inch	mm	pF/Ft	pF/m

24 AWG • SR-PVC/PVC

Stranded (7 x 32) TC Conductors • Semi-Rigid PVC Insulation • Overall Beldfoil® + 65% TC Braid Shielding • Chrome PVC Jacket										
9608	3	Chart 1	.190	4.83						
9609	4	Chart 1	.200	5.08	.011	.28	.035	.88	65	213
9610	5	Chart 1	.215	5.46						
9611	6	Chart 1	.225	5.72						
9612	7	Chart 1	.225	5.72						
9613	8	Chart 1	.240	6.10	.011	.28	.035	.88		
9614	9	Chart 1	.253	6.43						
9615	10	Chart 1	.270	6.86					55	180
9616	15	Chart 1	.300	7.62						
9617	25	Chart 1	.370	9.40	.011	.28	.037	.94		
9618	37	Chart 1	.411	10.43	.011	.28	.040	1.02		
9619	50	Chart 1	.485	12.32	.011	.28	.045	1.14		

* One conductor to other conductors connected to shield.

Multi-Conductor Computer Cables
Computer Cables for RS-232, RS-423, and IEEE 488

300 V, +80 °C • Foil/Braid Shield



- AWM Style
- VW-1

- NEC: CL2
- CSA: AWM I B FT4

Part No.	Conductors	Color Code	OD (Nom)		Insulation Thickness		Jacket Thickness		Capacitance*	
			Inch	mm	Inch	mm	Inch	mm	pF/Ft	pF/m

28 AWG • SR-PVC/PVC

Stranded (7 x 36) TC Conductors • Semi-Rigid PVC Insulation • Overall Beldfoil® + 65% TC Braid Shielding • Chrome PVC Jacket										
9637	25	Chart 2R	.305	7.75	.010	.25	.035	.89	50	164.05

* One conductor to other conductors connected to shield.

30 V, +80 °C • Foil/Braid Shield

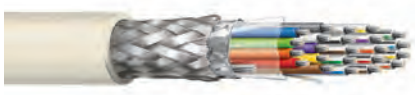

- AWM Style
- VW-1

- NEC: CL2
- CSA: AWM I A FT4

Part No.	Conductors	Color Code	OD (Nom)		Insulation Thickness		Jacket Thickness	
			Inch	mm	Inch	mm	Inch	mm

26 and 24 AWG • SR-PVC/PVC

Stranded (7 x 34 and 7 x 32) TC Conductors • Semi-Rigid PVC Insulation • Overall Beldfoil® + 90% TC Braid Shielding • 26 AWG Stranded TC Drain Wire • Chrome PVC Jacket										
9641	23 Total 6 (26 AWG Pairs) 10 (26 AWG Cond.) 1 (24 AWG Cond.)	Chart 1	.350	8.89	.010	.25	.035	.89		

TC = Tinned Copper • PVC = Polyvinyl Chloride | Belden Color Code Charts can be found at page 344.

Multi-Conductor Computer Cables

Low-Capacitance Computer Cables for RS-232 Applications

300 V, +80 °C • Low Capacitance • Foil/Braid Shield

- AWM Style

- NEC: CMG
- CEC: CMG FT4



Part No.	Conductors	Color Code	OD (Nom)		Insulation Thickness		Jacket Thickness		Capacitance*	
			Inch	mm	Inch	mm	Inch	mm	pF/Ft	pF/m

22 AWG • SR-PVC/PVC

Stranded (7 x 30) TC Conductors • Semi-Rigid PVC Insulation • Overall Beldfoil® + 65% TC Braid Shielding • Chrome PVC Jacket											
9939	3	Chart 1	.202	5.13							
9940	4	Chart 1	.215	5.46	.011	.28	.035	.89	67	220	
9941	5	Chart 1	.230	5.84							
9942	6	Chart 1	.245	6.22							
9943	7	Chart 1	.245	6.22							
9944	8	Chart 1	.264	6.71	.011	.28	.035	.89			
9945	9	Chart 1	.280	7.11							
9946	10	Chart 1	.300	7.62					63	207	
9947	15	Chart 2R	.340	8.64							
9948	25	Chart 2R	.410	10.41	0.11	.28	.040	1.02			
9949	37	Chart 2R	.460	11.68							
9950	50	Chart 2R	.555	14.10	0.11	.28	.050	1.27			

* One conductor to other conductors connected to shield.

Multi-Conductor Computer Cables

Low-Capacitance Computer Cables for RS-232 and RS-423 Applications

30 V, +80 °C • Low Capacitance • Foil/Braid Shield

• AWM Style

• NEC: CMG
• CEC: CMG FT4



Part No.	Conductors	Color Code	OD (Nom)		Insulation Thickness		Jacket Thickness		Capacitance*	
			Inch	mm	Inch	mm	Inch	mm	pF/Ft	pF/m

24 AWG • Datalene®/PVC

Stranded (7 x 32) TC Conductors • Datalene® Insulation • Overall Beldfoil® + 65% TC Braid Shielding • 24 AWG TC Drain Wire • Chrome PVC Jacket										
9925	3	Chart 1	.215	5.46						
9927	4	Chart 1	.230	5.84						
9929	5	Chart 1	.246	6.25						
9931	6	Chart 1	.265	6.73						
9932	7	Chart 1	.265	6.73	.015	.38	.035	.89		
9933	8	Chart 1	.280	7.11					22	72.2
9934	9	Chart 1	3.00	7.62						
9935	10	Chart 1	3.06	7.77						
9936	15	Chart 1	.350	8.89						
9937	25	Chart 1	.445	11.30						
9938	37	Chart 1	.500	12.70	.015	.38	.045	1.14		

* One conductor to other conductors connected to shield.

Datalene insulation features include a low dielectric constant and a low dissipation factor for high-speed, low-distortion data handling. Physical properties include good crush resistance and light weight.

TC = Tinned Copper • PVC = Polyvinyl Chloride | Belden Color Code Charts can be found at page 344.

Paired Computer Cables
Computer Cables for RS-232 Applications

300 V, +80 °C •
Overall Beldfoil® Shield



24 AWG • SR-PVC/PVC
• NEC: CMG
• CEC: CMG FT43

24 AWG • PE/LSZH
• Flame IEC 60332-3-24
• Smoke IEC 6103

Part No.	Pairs	Color Code	OD (Nom)		Insulation Thickness		Jacket Thickness		Capacitance				Additional Features/Ratings
			Inch	mm	Inch	mm	Inch	mm	Cond. - Cond.		Cond. - Shield		
									pF/Ft	pF/m	pF/Ft	pF/m	

24 AWG • SR-PVC/PVC

Stranded (7 x 32) TC Conductors • Semi-Rigid PVC Insulation • Overall Beldfoil® Shield • 24 AWG TC Drain Wire • Chrome PVC Jacket														
9501	1	Chart 3	.156	3.96	.011	.28	.032	.81		40	131	74	233	
9502	2	Chart 3	.222	5.64										
9503	3	Chart 3	.232	5.89										
9504	4	Chart 3	.265	6.73										
9505	5	Chart 3	.289	7.34										
9506	6	Chart 3	.289	7.34	.011	.28	.032	.81						
9507	7	Chart 3	.294	7.47										
9508	8	Chart 3	.324	8.23					30	98	50	164		
9509	9	Chart 3	.334	8.48										
9510	10	Chart 3	.368	9.34										
9515	15	Chart 3	.417	10.6	.011	.28	.034	.86						UL AWM Style 2464 CSA AWM 1A MSHA* (9502)
9519	19	Chart 3	.448	11.4										75 Ω Nominal Impedance 60% Velocity of Prop. Conductor DCR (Nom): 24.0 Ω/1000' (78.7 Ω/km)
9525	25	Chart 3	.503	12.8	.011	.28	.045	1.14						Shield DCR (Nom): 18.0 Ω/1000' (59.1 Ω/km)
9550	50	Chart 3	.708	18.0	.011	.28	.054	1.37						

24 AWG • PE/LSZH

Stranded (7 x 32) TC Conductors • Polyethylene Insulation • Overall Beldfoil® Shield • 24 AWG Stranded TC Drain Wire • Chrome LSZH Jacket														
9501NH	1	Chart 3	.160	4.15	.011	.28	.035	.90		40	131	74	243	
9502NH	2	Chart 3	.230	5.80										
9503NH	3	Chart 3	.240	6.07										
9504NH	4	Chart 3	.270	6.88										
9505NH	5	Chart 3	.300	7.50										
9506NH	6	Chart 3	.300	7.52	.011	.28	.035	.90	30	98	50	164		75 Ω Nominal Impedance, 60% Velocity of Prop., Conductor DCR (Nom): 24.0 Ω/1000' (78.7 Ω/km)
9507NH	7	Chart 3	.300	7.64										Shield DCR (Nom): 18.0 Ω/1000' (59.1 Ω/km)
9508NH	8	Chart 3	.330	8.40										
9510NH	10	Chart 3	.370	9.40										
9502LS	2	Chart 3	.390	10.00	.011	.28	0.035/ 0.051	0.90/ 1.30		30	98	50	164	75 Ω Nominal Impedance, 60% Velocity of Prop., Conductor DCR (Nom): 24.0 Ω/1000' (78.7 Ω/km)
														Shield DCR (Nom): 18.0 Ω/1000' (59.1 Ω/km) Steel Wire Armor

* MSHA = Mine Safety and Health Administration

Paired Computer Cables

Computer Cables for RS-232 Applications

Plenum • Overall Beldfoil® Shield



- Flame IEC 60332-3-24
- Smoke IEC 6103
- NEC: CMP
- CEC: CMP FT6

Part No.	Pairs	Color Code	OD (Nom)		Insulation Thickness		Jacket Thickness		Capacitance			
			Inch	mm	inch	mm	Inch	mm	Cond. - Cond.		Cond. - Shield	
									pF/Ft	pF/m	pF/Ft	pF/m

24 AWG • FEP/Flamarrest®

Stranded (7 x 32) TC Conductors • FEP Insulation • Overall Beldfoil® Shield • 24 AWG TC Drain Wire • Natural Flamarrest Jacket														
82641	1	Chart 3	.106	2.69	.006	.15	.014	.36	31	102	59	194		
82502	2	Chart 3	.162	4.11										
82503	3	Chart 3	.169	4.29										
82504	4	Chart 3	.193	4.90	.006	.15	.014	.36	25	82	45	148		
82505	5	Chart 3	.196	4.98										
82506	6	Chart 3	.209	5.31										
82509	9	Chart 3	.246	6.25	.006	.15	.015	.38	23	75	42	138		

24 AWG • FEP/FEP

Stranded (7 x 32) TC Conductors • FEP Insulation • Overall Beldfoil® Shield • 24 AWG TC Drain Wire • Red FEP Jacket														
88641	1	Chart 3	.106	2.69	.006	.15	.014	.36	31	102	59	194		
89503	3	Chart 3	.175	4.45										
89504	4	Chart 3	.192	4.88	.006	.15	.014	.36	21	69	40	131		
89505	5	Chart 3	.197	5.00										

TC = Tinned Copper • FEP = Fluorinated Ethylene Propylene • PVC = Polyvinyl Chloride | Belden Color Code Charts can be found at page 344.

Paired Computer Cables

Low-Capacitance Computer Cables for RS-232 and RS-422 Applications

Low Capacitance • Overall Beldfoil® Shield



Part No.	Pairs	Color Code	OD (Nom)		Insulation Thickness		Jacket Thickness		Capacitance				Additional Features/Ratings
			Inch	mm	Inch	mm	Inch	mm	Cond. - Cond.		Cond. - Shield		
									pF/Ft	pF/m	pF/Ft	pF/m	

28 AWG • Datalene®/PVC

Stranded (7 x 36) TC Conductors • Datalene Insulation • Overall Beldfoil® Shield • 28 AWG TC Drain Wire • Chrome PVC Jacket														
8132FO	2	Chart 5	.215	5.46										NEC: CL2 UL AWM Style 2919 (30 V, +80 °C) 120 Ω Nom. Impedance 78% Velocity of Prop. Conductor DCR (Nom): 65.0/1000' (213.0 Ω/km) Shield DCR (Nom): 23.1 Ω/1000' (75.8 Ω/km)
8134FO	4	Chart 5	.270	6.86										
8135FO	5	Chart 5	.280	7.11										
8138FO	8	Chart 5	.310	7.88	.015	.38	.035	.89	11.0	36.1	20.0	65.6		
8142FO	12.5	Chart 5	.385	9.78										

24 AWG • Polyethylene/PVC

Stranded (7 x 32) TC Conductors • Polyethylene Insulation • Overall Beldfoil® Shield • 24 AWG TC Drain Wire • Chrome PVC Jacket														
9680	3	Chart 5	.282	7.16										NEC: CM • CEC: CM UL AWM Style 2919 100 Ω Nom. Impedance 66% Velocity of Prop. Conductor DCR (Nom): 24.0/1000' (78.7 Ω/km)
9681	4	Chart 5	.307	7.80										
9682	6	Chart 5	.342	8.69	.016	.41	.035	.89	15.5	42.0	27.5	72.0		
9683	9	Chart 5	.397	10.10										
9684	12.5	Chart 5	.445	11.30										

24 AWG • Datalene/PVC

Stranded (7 x 32) TC Conductors • Datalene Insulation • Overall Beldfoil® Shield • 24 AWG TC Drain Wire • Chrome PVC Jacket														
1419A	2	Chart 5	.248	6.30										NEC: CM • CEC: CM CEC: FT! (1419A, 1420A) UL AWM Style 2919 100 Ω Nom. Impedance 78% Velocity of Prop. Conductor DCR (Nom): 24.0/1000' (78.7 Ω/km)
1420A	3	Chart 5	.261	6.63										
1421A	4	Chart 5	.280	7.11										
1422A	5	Chart 5	.294	7.47	.013	.33	.035	.89	15.5	42.0	27.5	72.0		
1423A	6	Chart 5	.319	8.10										
1424A	12.5	Chart 5	.418	10.62										
1425A	15	Chart 5	.473	12.01	.013	.33	.040	1.02						

TC = Tinned Copper • PVC = Polyvinyl Chloride | Belden Color Code Charts can be found at page 344.

Paired Computer Cables

Low-Capacitance 100 Ohm Computer Cables for RS-422 and Digital Audio Applications

Individually Shielded Pairs • RS-422 and Digital Audio



24 AWG • Datalene®/PVC
 • NEC: CM
 • CEC: CM

24 AWG • Datalene/LSZH
 • Flame IEC 60332-3-24
 • Smoke IEC 6103

Part No.	Pairs	Color Code	OD (Nom)		Insulation Thickness		Jacket Thickness		Capacitance				Additional Features/Ratings	
			Inch	mm	Inch	mm	Inch	mm	Cond. - Cond.		Cond. - Shield			
										pF/Ft	pF/m	pF/Ft	pF/m	

24 AWG • Datalene®/PVC

Stranded (7 x 32) TC Conductors • Datalene Insulation • Individually Beldfoil® Shielded Pairs • Chrome PVC Jacket														
9729	2	Chart 3	.266	6.76										
9730	3	Chart 3	.334	8.48										
9728	4	Chart 3	.363	9.22	.019	.48	.048	1.22						
9731	6	Chart 3	.421	10.69										
9732	9	Chart 3	.488	12.40										
9734	12	Chart 3	.575	14.61	.019	.48	.063	1.60	12.5	41.0	23.2	76.1	UL AWM Style 2493 (300 V, +60 °C) 100 Ω Nom. Impedance 76% Velocity of Prop. Conductor DCR (Nom): 24.0 Ω/1000' (78.7 Ω/km)	
9735	15	Chart 3	.639	16.23										
9736	17	Chart 3	.671	17.04										
9737	19	Chart 3	.671	17.04	.019	.48	.065	1.65						
9738	27	Chart 3	.797	20.24										

24 AWG • Datalene/LSZH

Stranded (7 x 32) TC Conductors • Datalene Insulation • Individually Beldfoil® Shielded Pairs • Chrome LSZH Jacket													
9729NH	2	Chart 3	.310	7.90	.019	.48	.045	1.14	12	41	23	76	100 Ω Nom. Impedance, 76% Velocity of Prop., Conductor DCR (Nom): 24.0 Ω/1000' (78.7 Ω/km)
9729LS	2	Chart 3	.490	12.50	.019	.48	0.045/ 0.053	1.14/ 1.35	12	41	23	76	100 Ω Nom. Impedance, 76% Velocity of Prop., Conductor DCR (Nom): 24.0 Ω/1000' (78.7 Ω/km) Steel Wire Armor

TC = Tinned Copper • PVC = Polyvinyl Chloride • LSZH = Low Smoke Zero Halogen | Belden Color Code Charts can be found at page 344.

Paired Computer Cables

Low-Capacitance 100 Ohm Computer Cables for RS-422 and Digital Audio Applications

Plenum • Individually Shielded Pairs • RS-232, RS-422, and Digital Audio

- NEC: CMP
- CEC: CMP FT6



Part No.	Pairs	Color Code	OD (Nom)		Insulation Thickness		Jacket Thickness		Capacitance				Additional Features/Ratings
			Inch	mm	Inch	mm	Inch	mm	Cond. - Cond.		Cond. - Shield		
									pF/Ft	pF/m	pF/Ft	pF/m	

24 AWG • FEP/Fluorocopolymer

Stranded (7 x 32) TC Conductors • Foam FEP Insulation • Individually Beldfoil® Shielded Pairs • 24 AWG TC Drain Wire • Gray Fluorocopolymer Jacket														
89729	2	Chart 5	.261	6.63										Plenum 300 V
89730	3	Chart 5	.278	7.06	.019	.48	.017	.43						100 Ω Nom. Impedance
89728	4	Chart 5	.307	7.80					13.5	44	22.5	73.8		76% Velocity of Prop. Conductor DCR (Nom): 23.3 Ω/1000' (76.4 Ω/km)
89731	6	Chart 5	.361	9.17	.019	.48	.014	.36						
89732	9	Chart 5	.429	10.90	.019	.48	.016	.41						

24 AWG • FEP/Flamarrest®

Stranded (7 x 32) TC Conductors • Foam FEP Insulation • Individually Beldfoil® Shielded Pairs • 24 AWG TC Drain Wire • Natural Flamarrest Jacket														
82729	2	Chart 5	.255	6.48	.019	.48	.014	.36	13.5	44	22.5	73.8		300 V 100 Ω Nom. Impedance 76% Velocity of Prop. Conductor DCR (Nom): 23.3 Ω/1000' (76.4 Ω/km)

TC = Tinned Copper • FEP = Fluorinated Ethylene Propylene | Belden Color Code Charts can be found at page 344.

Paired Computer Cables

Low-Capacitance Computer Cables for RS-232 Applications

Overall Foil/Braid Shield • RS-232



- NEC: CMG
- CEC: CMG FT4

Part No.	Pairs	Color Code	OD (Nom)		Insulation Thickness		Jacket Thickness		Capacitance				Additional Features/Ratings
			Inch	mm	Inch	mm	Inch	mm	Cond. - Cond.		Cond. - Shield		
									pF/Ft	pF/m	pF/Ft	pF/m	

22 AWG • SR-PVC/PVC

Stranded (7 x 30) TC Conductors • Semi-Rigid Insulation • Overall Beldfoil® + 65% TC Braid Shield • Chrome PVC Jacket															
8302	2	Chart 3	.260	6.60							40	131	72	236	
8303	3	Chart 3	.270	6.86											
8304	4	Chart 3	.320	8.13											
8305	5	Chart 3	.322	8.18	.011	.28	.035	.89							
8306	6	Chart 3	.348	8.84											
8307	7	Chart 3	.348	8.84											
8308	8	Chart 3	.384	9.75						35	115	63	207		
8310	10	Chart 3	.440	11.18											
8312	12	Chart 3	.455	11.56	.011	.28	.040	1.02							
8315	15	Chart 3	.502	12.75											
8318	18	Chart 3	.535	13.59											
8325	25	Chart 3	.620	15.75	.011	.28	.045	1.14							

UL AWM Style 2464
(300 V, +80 °C)
70 Ω Nom. Impedance
60% Velocity of Prop.
Conductor DCR (Nom):
15.0 Ω/1000'
(49.2 Ω/km)

TC = Tinned Copper • PVC = Polyvinyl Chloride | Belden Color Code Charts can be found at page 344.

Paired Computer Cables

Low-Capacitance Computer Cables for RS-232 and RS-422 Applications

Overall Foil/Braid Shield • RS-232



- NEC: CMG
- CEC: CMG FT4

Part No.	Pairs	Color Code	OD (Nom)		Insulation Thickness		Jacket Thickness		Capacitance				Additional Features/Ratings
			Inch	mm	Inch	mm	Inch	mm	Cond. - Cond.		Cond. - Shield		
									pF/Ft	pF/m	pF/Ft	pF/m	

24 AWG • SR-PVC/PVC

Stranded (7 x 32) TC Conductors • Semi-Rigid PVC Insulation • Overall Beldfoil® + 65% TC Braid Shield • Chrome PVC Jacket														
8332	2	Chart 5	.250	6.35										
8333	3	Chart 5	.265	6.73										
8334	4	Chart 5	.288	7.32										
8335	5	Chart 5	.295	7.49	.011	.28	.035	.89						
8336	6	Chart 5	.310	7.87										
8337	7	Chart 5	.321	8.15					30	98	50	165		
8340	10	Chart 5	.385	9.78										
8342	12.5	Chart 5	.405	10.29										
8345	15	Chart 5	.445	11.30	.011	.28	.040	1.02						
8348*	18	Chart 5	.480	12.19										
8355*	25	Chart 5	.550	13.97	.011	.28	.045	1.14						

UL AWM Style 2464
(300 V, +80 °C)
CSA AWM I A
75 Ω Nom. Impedance
60% Velocity of Prop.
Conductor DCR (Nom):
24.0 Ω/1000'
(78.7 Ω/km)

* Not Rated for CSA AWM I A, 300 V, +80 °C

Overall Foil/Braid Shield • RS-232/422

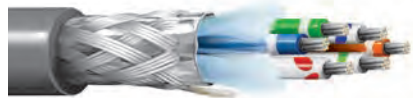

24 AWG • Polyethylene/PVC

- NEC: CM
- CEC: CM

24 AWG • Polyethylene/LSZH

- Flame IEC 60332-3-24
- Smoke IEC 6103

Part No.	Pairs	Color Code	OD (Nom)		Insulation Thickness		Jacket Thickness		Capacitance				Additional Features/Ratings
			Inch	mm	Inch	mm	Inch	mm	Cond. - Cond.		Cond. - Shield		
									pF/Ft	pF/m	pF/Ft	pF/m	

24 AWG • Polyethylene/PVC

Stranded (7 x 32) TC Conductors • Polyethylene Insulation • Overall Beldfoil® + 65% TC Braid Shield • 24 AWG Stranded TC Drain Wire • Chrome PVC Jacket														
9829	2	Chart 5	.291	7.39										
9830	3	Chart 5	.305	7.74										
9831	4	Chart 5	.330	8.38										
9832	5	Chart 5	.338	8.59										
9839	6	Chart 5	.364	9.25	.016	.41	.035	.89	15.5	50.9	27.5	90.2		
9833	7	Chart 5	.370	9.40										
9834	9	Chart 5	.419	10.64										
9835	10	Chart 5	.451	11.46										
9836	12	Chart 5	.464	11.79										
9837	18	Chart 5	.567	14.40										

UL AWM Style 2919
(30 V, +80 °C)
100 Ω Nom. Impedance
66% Velocity of Prop.
Conductor DCR (Nom):
24.0 Ω/1000'
(78.7 Ω/km)

24 AWG • Polyethylene/LSZH

Stranded (7 x 32) TC Conductors • Polyethylene Insulation • Overall Beldfoil® + 65% TC Braid • 24 AWG • Stranded TC Drain Wire • Chrome LSZH Jacket														
9829NH	2	Chart 5	.280	7.10	.016	.41	.035	.89	16.0	50.9	27.0	90.2		

100 Ω Nom. Impedance,
66% Velocity of Prop.,
Conductor DCR (Nom):
24.0 Ω/1000'
(78.7 Ω/km)

TC = Tinned Copper • PVC = Polyvinyl Chloride • LSZH = Low Smoke Zero Halogen | Belden Color Code Charts can be found at page 344.

Paired Computer Cables

Low-Capacitance Computer Cables for RS-232 and RS-422 Applications

Overall Foil/Braid Shield • RS-232/422



24 AWG • Datalene®/PVC
 • NEC: CM
 • CEC: CM

24 AWG • Datalene/LSZH
 • Flame IEC 60332-3-24
 • Smoke IEC 6103

Part No.	Pairs	Color Code	OD (Nom)		Insulation Thickness		Jacket Thickness		Capacitance				Additional Features/Ratings	
			Inch	mm	Inch	mm	Inch	mm	Cond. - Cond.		Cond. - Shield			
										pF/Ft	pF/m	pF/Ft	pF/m	

24 AWG • Datalene®/PVC

Stranded (7 x 32) TC Conductors • Datalene Insulation • Overall Beldfoil® + 65% TC Braid Shield • 24 AWG Stranded TC Drain Wire • Chrome PVC Jacket														
8102	2	Chart 5	.270	6.86										
8103	3	Chart 5	.283	7.19										
8104	4	Chart 5	.302	7.67										
8105	5	Chart 5	.316	8.03										
8106	6	Chart 5	.341	8.66	.013	.33	.035	.89						
8107	7	Chart 5	.341	8.66										
8108	8	Chart 5	.370	9.40					12.5	41	22	72.2	UL AWM Style 2919 (30 V, +80 °C)	
8110	10	Chart 5	.427	10.85									100 Ω Nom. Impedance	
8112	12.5	Chart 5	.440	11.18									78% Velocity of Prop.	
8115	15	Chart 5	.495	12.57	.015	.38	.040	1.02					Conductor DCR (Nom):	
8118	18	Chart 5	.537	13.64	.015	.38	.048	1.22					24.0 Ω/1000'	
8125	25	Chart 5	.632	16.05	.015	.38	.050	1.27					(78.7 Ω/km)	

24 AWG • Datalene/LSZH

Stranded (7 x 32) TC Conductors • Datalene Insulation • Overall Beldfoil® + 65% TC Braid • 24 AWG • Stranded TC Drain Wire • Chrome LSZH Jacket														
8102NH	2	Chart 5	.270	6.90	.013	.33	.031	.80						
8110NH	10	Chart 5	.410	10.29	.013	.33	.033	.83	12.0	41	22	72.2	100 Ω Nom. Impedance,	
													78% Velocity of Prop.,	
													Conductor DCR (Nom):	
													24.0 Ω/1000'	
													(78.7 Ω/km)	

TC = Tinned Copper • PVC = Polyvinyl Chloride • LSZH = Low Smoke Zero Halogen | Belden Color Code Charts can be found at page 344.

Paired Computer Cables

Low-Capacitance Computer Cables for RS-232, RS-422, and RS-485 Applications

Overall Foil/Braid Shield • RS-232/422

- NEC: CL2



Part No.	Pairs	Color Code	OD (Nom)		Insulation Thickness		Jacket Thickness		Capacitance				Additional Features/Ratings
			Inch	mm	Inch	mm	Inch	mm	Cond. - Cond.		Cond. - Shield		
									pF/Ft	pF/m	pF/Ft	pF/m	

28 AWG • Polypropylene/PVC

Stranded (7 x 36) TC Conductors • Polypropylene Insulation • Overall Beldfoil® + 90% TC Braid Shield • 28 AWG Stranded TC Drain Wire • Chrome PVC Jacket														
9804	2	Chart 3	.214	5.44	.009	.23	.042	1.07						
9805	3	Chart 3	.222	5.64										
9806	4	Chart 3	.237	6.02										
9807	5	Chart 3	.240	6.10										
9808	7	Chart 3	.256	6.50										
9809	9	Chart 3	.290	7.37	.009	.23	.035	.89	15.5	50.9	27.5	90.2	UL AWM Style 2960 (30 V, +60 °C) 100 Ω Nom. Impedance 66% Velocity of Prop. Conductor DCR (Nom): 64.9 Ω/1000' (212.9 Ω/km)	
9812	12	Chart 3	.319	8.10										
9813	13	Chart 3	.336	8.53										
9819	18	Chart 3	.365	9.27										
9825	25	Chart 3	.429	10.90										
9814	31	Chart 3	.462	11.73	.009	.23	.040	1.02						

Overall Foil/Braid Shield • RS-232/485

- NEC: CL2



Part No.	Pairs	Color Code	OD (Nom)		Insulation Thickness		Jacket Thickness		Capacitance				Additional Features/Ratings
			Inch	mm	Inch	mm	Inch	mm	Cond. - Cond.		Cond. - Shield		
									pF/Ft	pF/m	pF/Ft	pF/m	

28 AWG • Datalene®/PVC

Stranded (7 x 36) TC Conductors • Datalene Insulation • Overall Beldfoil® + 65% TC Braid Shield • 28 AWG Stranded TC Drain Wire • Chrome PVC Jacket														
8132	2	Chart 5	.220	5.59										
8133	3	Chart 5	.270	6.86										
8134	4	Chart 5	.290	7.37	.015	.38	.035	.89						
8135	5	Chart 5	.300	7.62										
8138	8	Chart 5	.330	8.38	.015	.38	.039	.99	11.0	36.1	20.0	65.6	UL AWM Style 2919 (30 V, +80 °C) 120 Ω Nom. Impedance 78% Velocity of Prop. Conductor DCR (Nom): 65.0 Ω/1000' (213.0 Ω/km)	
8142	12.5	Chart 5	.375	9.53	.015	.38	.035	.89						
8148	18	Chart 5	.465	11.81	.015	.38	.045	1.14						
8155	25	Chart 5	.565	14.35	.015	.38	.044	1.12						

TC = Tinned Copper • PVC = Polyvinyl Chloride | Belden Color Code Charts can be found at page 344.

Paired Computer Cables

Low-Capacitance Computer Cables for RS-485 Applications

Overall Foil/Braid Shield • RS-485 • DMX512



- 24 AWG • Polyethylene/PVC
- NEC: CM
 - CEC: CM

- 24 AWG • Polyethylene/LSZH
- Flame IEC 60332-3-24
 - Smoke IEC 6103

Part No.	Pairs	Color Code	OD (Nom)		Insulation Thickness		Jacket Thickness		Capacitance				Additional Features/Ratings
			Inch	mm	Inch	mm	Inch	mm	Cond. - Cond.		Cond. - Shield		
									pF/Ft	pF/m	pF/Ft	pF/m	

24 AWG • Polyethylene/PVC

Stranded (7 x 32) TC Conductors • Polyethylene Insulation • Overall Beldfoil® + 90% TC Braid Shield • 24 AWG Stranded TC Drain Wire • Chrome PVC Jacket														
9841	1	Chart 5	.232	5.89	.023	.58	.035	.89						UL AWM Style 2919 (30 V, +80 °C) ANSI E1.11 DMX512 120 Ω Nom. Impedance 66% Velocity of Prop. Conductor DCR (Nom): 24.0 Ω/1000' (78.7 Ω/km)
9842	2	Chart 5	.340	8.64										
9843	3	Chart 5	.360	9.14					12.8	42.0	23.0	75.5		
9844	4	Chart 5	.390	9.91	.022	.56	.035	.89						

24 AWG • Polyethylene/LSZH

Stranded (7 x 32) TC Conductors • Polyethylene Insulation • Overall Beldfoil® + 90% TC Braid • 24 AWG Stranded TC Drain Wire • Chrome LSZH Jacket														
9841NH	1	Chart 5	.230	5.90										120 Ω Nom. Impedance, 66% Velocity of Prop., Conductor DCR (Nom): 24.0 Ω/1000' (78.7 Ω/km)
9842NH	2	Chart 5	.340	9.65	.023	.58	.035	.89	12.8	42.0	23.0	75.5		
9843NH	3	Chart 5	.360	9.10										
9844NH	4	Chart 5	.390	9.90										
9841LS	1	Chart 5	.410	10.30										120 Ω Nom. Impedance, 66% Velocity of Prop., Conductor DCR (Nom): 24.0 Ω/1000' (78.7 Ω/km) Steel Wire Armor
9842LS	2	Chart 5	.520	13.10	.023	.58	.035/.053	.89/1.35	12.8	42.0	23.0	75.5		
9844LS	4	Chart 5	.590	15.10										

Plenum • Overall Foil/Braid Shield • RS-485

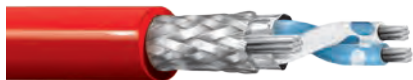

- NEC: CMP
- CEC: CMP FT6

Part No.	Pairs	Color Code	OD (Nom)		Insulation Thickness		Jacket Thickness		Capacitance				Additional Features/Ratings
			Inch	mm	Inch	mm	Inch	mm	Cond. - Cond.		Cond. - Shield		
									pF/Ft	pF/m	pF/Ft	pF/m	

24 AWG • FEP/Flamarrest®

Stranded (7 x 32) TC Conductors • Foam FEP Insulation • Overall Beldfoil® + 90% TC Braid Shield • 24 AWG Stranded TC Drain Wire • Natural Flamarrest Jacket														
82841	1	Chart 5	.204	5.18	.025	.64	.015	.38						Plenum 300 V 120 Ω Nom. Impedance 76% Velocity of Prop. Conductor DCR (Nom): 24.0 Ω/1000' (78.7 Ω/km)
82842	2	Chart 5	.273	6.93	.019	.48	.015	.38	12	39.4	22	72.2		

24 AWG • FEP/FEP

Stranded (7 x 32) TC Conductors • Foam FEP Insulation • Overall Beldfoil® + 90% TC Braid Shield • 24 AWG Stranded TC Drain Wire • Red FEP Jacket														
89841	1	Chart 5	.202	5.13	.025	.64	.014	.36						Plenum 300 V 120 Ω Nom. Impedance 76% Velocity of Prop. Conductor DCR (Nom): 24.0 Ω/1000' (78.7 Ω/km)
89842	2	Chart 5	.305	7.75	.023	.58	.014	.36	12	39.4	22	72.2		

TC = Tinned Copper • FEP = Fluorinated Ethylene Propylene • PVC = Polyvinyl Chloride • LSZH = Low Smoke Zero Halogen | Belden Color Code Charts can be found at page 344.

Paired Computer Cables

Computer POS Cables

Overall Foil/Braid Shield • RS-485 • POS



Part No.	Pairs	Color Code	OD (Nom)		Insulation Thickness		Jacket Thickness		Braid	Capacitance				Additional Features/Ratings
			Inch	mm	Inch	mm	Inch	mm		Cond. - Cond.		Cond. - Shield		
										pF/Ft	pF/m	pF/Ft	pF/m	

22 AWG • Polyethylene/PVC

Solid TC or BC Conductors • Polyethylene Insulation • Overall Beldfoil® + TC Braid Shield • 22 AWG Solid TC Drain Wire • Black PVC Jacket														
1268A	2 TC	Note 1	.270	6.86	.019	.48	.033	.84	90%	15.5	50.9	27.5	90.2	NEC: CM • CEC: CM UL AWM Style 2582 (150 V, +60 °C) 66% Velocity of Prop.
9855	2 TC	Note 1	.270	6.86					58%					
9696	2 BC	Note 2	.290	7.37	.018	.44	.033	.84	58%	16.0	52.5	27.5	90.2	

22 AWG • FEP/PVC

Solid TC or BC Conductors • FEP Insulation • Overall Beldfoil® + TC Braid Shield • 22 AWG Solid TC Drain Wire • Black PVC Jacket														
1269A	2 TC	Note 1	.240	6.10	.016	.41	.016	.43	90%					Plenum • Non-conduit NEC: CMP • CEC: CMP FT6 69.5% Velocity of Prop.
89855	2 TC	Note 1	.272	6.91	.016	.41	.016	.41	58%	15.5	50.9	27.0	88.6	
89696	2 BC	Note 2	.262	6.65	.020	.51	.016	.41						

Note 1: Red-Blue, Black-Yellow

Note 2: Blue-White with Blue Stripe, Orange-White with Orange Stripe

Paired Computer Cables

Low-Capacitance Computer Cables for RS-232, RS-422, and Digital Audio Applications

Individually Shielded Pairs with Overall Foil/Braid Shield

- NEC: CM
- CEC: CM

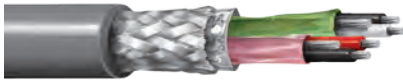

Part No.	Pairs	Color Code	OD (Nom)		Insulation Thickness		Jacket Thickness		Capacitance				Additional Features/Ratings
			Inch	mm	Inch	mm	Inch	mm	Cond. - Cond.		Cond. - Shield		
									pF/Ft	pF/m	pF/Ft	pF/m	

24 AWG • Datalene®/PVC

Stranded (7 x 32) TC Conductors • Datalene Insulation • Individually Beldfoil® Shielded Pairs + Overall 65% TC Braid Shielding • 24 AWG TC Drain Wire • Chrome PVC Jacket												
8162	2	Chart 3	.343	8.71								
8263	3	Chart 3	.359	9.12								
8164	4	Chart 3	.388	9.86								
8165	5	Chart 3	.413	10.49	.019	.48	.048	1.22				
8166	6	Chart 3	.446	11.33								
8167	7	Chart 3	.446	11.33					12.5	41	22	72.2
8168	8	Chart 3	.479	12.17								
8170	10	Chart 3	.584	14.83	.019	.48	.063	1.60				
8175	15	Chart 3	.665	16.89								
8178	18	Chart 3	.686	17.42	.019	.48	.065	1.65				
8185	25	Chart 3	.822	20.88								

UL AWM Style 2493
 (+60 °C)
 VW-1
 100 Ω Nom. Impedance
 78% Velocity of Prop.
 Conductor DCR (Nom):
 24.0 Ω/1000'
 (78.7 Ω/km)

TC = Tinned Copper • PVC = Polyvinyl Chloride | Belden Color Code Charts can be found at page 344.



Advanced networks
need advanced
technology.

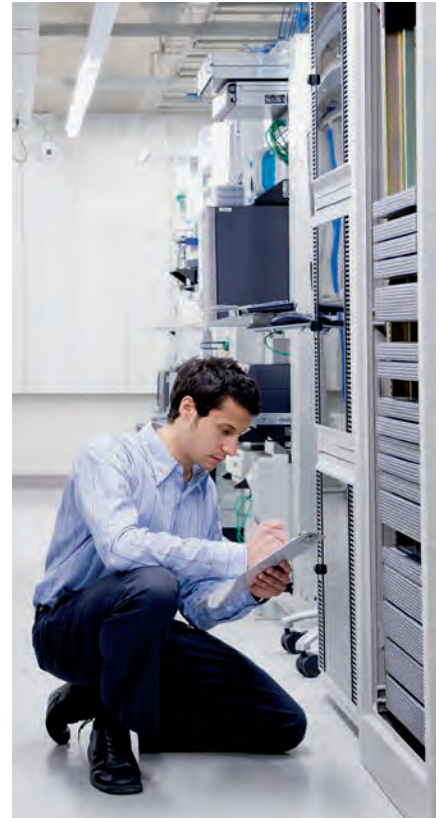



Industrial Data and Process Automation

Section Table of Contents

Industrial Data and Process Automation

Overview	218
Introduction	218–219
PLC/DCS-to-Cable Cross Reference Guide	220–222
Protocol-to-Cable Cross Reference Guide	223–224



Industrial Data and Process Automation



Tough Cables for Tough Environments

Today, more than ever, manufacturing productivity depends upon seamless data communication and automation systems. And both depend upon high-performance cabling solutions.

Depend on Belden

Belden has developed the world's most comprehensive line of industrial cabling solutions for applications like yours: whether you are networking your factory floor or your process equipment and devices to their controllers...and on to the control room, the engineering department, and remote manufacturing sites – or, all of the above. From your petrochemical, automotive manufacturing, pharmaceutical, power generation, pulp and paper, metals, food and beverage, or general manufacturing plant to your corporate headquarters – and everywhere in between – Belden has your cabling solution.

Most importantly you can have the peace-of-mind that is inherent with the use of Belden products since all Belden cables are manufactured in ISO 9001:2000 certified

facilities to the industry's highest standards of quality, using the most advanced equipment, systems, controls and processes available.

Belden cables give you the performance you need day after dependable day.

Innovative Technology

Bonded-Pair™ Cable

Many DataTuff® Industrial Ethernet cables feature Belden's patented bonded-pair technology. Bonded-pairs provide Installable Performance® – superior electrical performance even after the stresses of installation. Bonded-pairs exhibit the most robust and reliable electrical performance in the industry.

Shielding

Effective cable shielding for protection from noise interference remains critical with evolving industrial technology. Belden's shielding designs and testing methods ensure signal integrity and a dependable cable in the presence of electrical noise.

Belden's exclusive patented Beldfoil® design, with its aluminum/polyester foil, was the first shield to offer 100 percent cable protection against radiated emission and ingress at audio and radio frequencies.

Armoring

Belden's innovative armoring technology delivers maximum physical protection in harsh environments. Additional benefits include reduced cost of conduit, easier installation and re-routing, plus additional shielding.

Belden has the capability to protect data, electronic, instrumentation and control cables with interlocking steel or aluminum armor as well as continuous corrugated aluminum armor. Smooth or corrugated protective metal tapes are also available.



Insulation and Jacket

Belden formulates many of its own insulation and jacket compounds. As a result, they provide superior performance under a variety of hostile environmental conditions.

Intrinsically Safe Wiring

In accordance with NEC Article 504, intrinsically safe cables are colored blue for easy identification. Belden offers several industrial cables in intrinsically safe blue to meet your requirements for intrinsically safe wiring. Contact the NEC and/or your local inspector for specific guidelines.

Custom Capabilities

Most of our industrial cables are available from stock. Many of these are available off the shelf from distributors. If you have a new or unusual application or you cannot find an Industrial cable in this catalog section that meets your technical requirements, contact Technical Support at +31-77-3878-555.

Overall Jacket

Material
PUR
FRNC
PVC
CPE
TPE
HDPE

Armor

Material
Steel Wire, Aluminum Interlock
Steel Interlock
Aluminum Belclad®
Steel Belclad
Copper Belclad
Continuous Armor

PLC/DCS Cable Cross Reference Guide

PLC/DCS Manufacturer	System Name	Belden Part Number		
ABB/Bailey Controls	FOUNDATION Fieldbus	See Protocol listings on pages 223–224		
	Industrial IT 800 X A	9880	Network Trunk Cable	
	Infinet	9880	Network Trunk Cable	
		9463	Blue Hose® (Standard)	
	Masterpiece 200	9880	Network Trunk Cable	
		9907	Thin Network Trunk Cable	
	MICRO-DCI	3105A	1-Pair, RS-485	
	MICROLINK	9860	Twinax, 16 AWG, 124 Ohm	
	Modcell	3105A	1-Pair, RS-485	
	PROFIBUS DP & PA	See Protocol listings on pages 223–224		
Allen-Bradley/Rockwell Automation	ControlNet™	See Protocol listings on pages 223–224		
	DeviceNet™	See Protocol listings on pages 223–224		
	DH, DH+, Remote I/O	9463	Blue Hose (Standard)	
		9463F	Flexible Version (9463)	
		129463	Aluminum Armor (9463)	
		139463	Steel Armor (9463)	
		189463	Continuous Armor (9463)	
		9463DB	Direct Burial (9463)	
		3072F	600 V TC Rated (9463)	
		89463	FEP 200 °C, Plenum	
		DH-485	3074F	600 V Tray Cable
		3106A	1.5-Pair, RS-485 (PLTC)	
		9842	2-Pair, RS-485	
	Industrial Ethernet	See pages 251–268		
	Longline Communications	8723	Interface Cable	
		88723	Plenum Version	
	Cutler-Hammer/Westinghouse	I/Q System	9463	Blue Hose (Standard)
	Emerson Process Management (Fisher/Rosemont Systems) – Delta V	DeviceNet	See Protocol listings on pages 223–224	
		FOUNDATION Fieldbus (Type SP50 ISA/IEC)	See Protocol listings on pages 223–224	
HART		See Protocol listings on pages 223–224		
Industrial Ethernet		See pages 251–268		
MODBUS		See Protocol listings on pages 223–224		
PROFIBUS DP		See Protocol listings on pages 223–224		
Provox Plus		3094A*	RG-11 Quad Shield PVC	
		3131A	RG-6 Quad Shield PVC	
RS-485	See Protocol listings on pages 223–224			
GE Fanuc – I/O Bus	DeviceNet	See Protocol listings on pages 223–224		
	9030, 9070	9182	Communications Bus	
	PAC System	89182	Plenum Version	
	INTERBUS®-S	See Protocol listings on pages 223–224		
	MODBUS®	See Protocol listings on pages 223–224		
	PROFIBUS	See Protocol listings on pages 223–224		

PLC/DCS Manufacturer	System Name	Belden Part Number	
GE Fanuc – Sensor Device Networks	DeviceNet	See Protocol listings on pages 223–224	
	SDS	See Protocol listings on pages 223–224	
Honeywell	Access 4000 System	9248*	RG-6 PVC
	FOUNDATION Fieldbus (Type SP50 ISA/IEC)	See Protocol listings on pages 223–224	
	IPC 620 System I/O	9271	Twinax, 25 AWG, 124 Ohm
	IPC 620 System	9729	Up to 4000 ft. (1220 m)
	Serial Interface	9182	Up to 10,000 ft. (3050 m)
		89182	Plenum
	Series C	RS-485	FOUNDATION Fieldbus Industrial Ethernet
	3000 UCN & LCN	3131A	RG-6 Quad Shield PVC
		3094A	RG-11 Quad Shield PVC
	Honeywell Microswitch Division	Smart Distributed System	3086A
3087A			Micro
1346F			1 Pair 22 AWG, 1 Pair 24 AWG
1348A			3 20 AWG
1349A			3 20 AWG, 2 18 AWG
Invensys/Foxboro			FOUNDATION Fieldbus (Type SP50 ISA/IEC)
	I/A Series Carrier Band	8233*	Small Trunk
		3095A	Plenum
		9290*	Drop Cable
	I/A Series Fieldbus	9207	Twinax
		89207	200 °C, Plenum
		3073F	600 V Tray Cable
	I/A Series Node Bus	9880	Trunk Cable
		89880	Plenum Version
	Industrial Ethernet	See pages 251–268	
Limitorque	DCC100	3105A	Actuator Bus Cable, 1-Pair, RS-485
Matsushita	FP Series C-NET	9207	Twinax, 20 AWG, Stranded, 100 Ohm
		9860	Twinax, 16 AWG, Solid, 124 Ohm
	FP Series MEWNET-F	9207	Twinax, 20 AWG, Stranded, 100 Ohm
		9860	Twinax, 16 AWG, Solid, 124 Ohm
	FP Series MEWNET-H	9248*	RG-6, 75 Ohm, 18 AWG
	FP Series MEWNET-TR	9207	Twinax, 20 AWG, Stranded, 100 Ohm
		9860	Twinax, 16 AWG, Solid, 124 Ohm
	FP Series MEWNET-W	9207	Twinax, 20 AWG, Stranded, 100 Ohm
		9806	4-Pair, RS-232, RS-422
	FP Series MEWNET-W2	9207	Twinax, 20 AWG, Stranded, 100 Ohm
9860*		Twinax, 16 AWG, Solid, 124 Ohm	
FP Series TRNET	9207	Twinax, 20 AWG, Stranded, 100 Ohm	
	9860	Twinax, 16 AWG, Solid, 124 Ohm	

FEP = Fluorinated Ethylene-propylene
PVC = Polyvinyl Chloride
TC = Tinned Copper

PLC/DCS Manufacturer	System Name	Belden Part Number		
Mitsubishi Electric Automation	CC-Link	See Protocol listings on pages 223–224		
	DeviceNet	See Protocol listings on pages 223–224		
	Melsecnet II (10/10H)	1505A*	Precision RG-59/U Coax	
		1505F*	High-Flex 1505A	
		1506A*	Plenum Precision RG-59/U, Outdoor, Direct Burial	
		8241*	Standard RG-59/U Coax	
		8241F*	High-Flex 8241F	
	MODBUS	See Protocol listings on pages 223–224		
	PROFIBUS DP	See Protocol listings on pages 223–224		
	Serial Communications	8777 Control and Instrumentation Interconnect Cable		
Modicon/Schneider AEG	Industrial Ethernet	See pages 251–268		
	MODBUS	8777	Modem Drop Cable, 22 AWG, 3-Pair	
		8777NH	22 AWG, 3-Pair, LSNH	
		8777LS	22 AWG, 3-Pair, Steel Wire Armor	
		128777	Aluminum Armor (8777)	
		138777	Steel Armor (8777)	
		88777	FEP 200 °C, Plenum	
		3092A	RG-6 Quad Shield PVC	
	MODBUS II	3132A	RG-6 Quad Shield, 150 °C, Plenum	
		3092F	RG-6 Quad Shield PVC, Flexible Version	
		123092A	Aluminum Armor (3092A)	
		133092A	Steel Armor (3092A)	
		123092F	Aluminum Armor, RG-6 Quad Shield PVC	
	Remote I/O	3132A	RG-6 Quad Shield, 150 °C, Plenum	
		3094A	RG-11 Quad Shield PVC	
		123094A	Aluminum Armor (3094A)	
		133094A	Steel Armor (3094A)	
		3095A	RG-11 Quad Shield, 150 °C, Plenum	
		ComboBus/D (DeviceNet™)	See DeviceNet Protocol listings on pages 223–224	
			ComboBus/S	9409*
		9318*		18 AWG, 1-Pair, 300 V PLTC Control, Shielded
		3073F		600 V Tray Cable, Twinax
		89740*		18 AWG, 1-Pair, 300 V, Control

PLC/DCS Manufacturer	System Name	Belden Part Number	
Omron (continued)	Controller Link	9207	Twinax
		89207	Twinax, 200 °C, Plenum
		9815*	Twinax, 100 Ohm, Direct Burial
		3073F	600 V Tray Cable, Twinax
		3073F	600 V Tray Cable, Twinax
	SYSBUS-2	3073F	600 V Tray Cable, Twinax
	SYSMAC BUS	9841	22 AWG, 1-Pair, RS-485
		3105A	22 AWG, 1-Pair, RS-485
	SYSMAC LINK	9231*	RG-59U Coax
	Phoenix Contact	DeviceNet	See Protocol listings on pages 223–224
Industrial Ethernet		See pages 251–268	
INTERBUS®-S		See Protocol listings on pages 223–224	
PROFIBUS DP FMS & PA		See Protocol listings on pages 223–224	
Reliance/A-B	Auto Max Distributed Power	B9B012*	2-Fiber Breakout
		1100255*	2-Fiber Loose Tube PVC
		1100266*	2-Fiber Loose Tube CPE
	R-Net	9259*	RG-59 PVC
	89259*	RG-59, 200 °C, Plenum	
Rotork	Pakscan II E RS-485	3105A	22 AWG, 1-Pair, RS-485
Siemens/ Moore	FMC (Field Mountable Controller)	3105A	1-Pair, RS-485
		3106A	1.5-Pair, RS-485
		3107A	2-Pair, RS-485
		3108A	3-Pair, RS-485
		3109A	4-Pair, RS-485
	FOUNDATION Fieldbus (Type SP50 ISA/IEC)	See Protocol listings on pages 223–224	
	Hiway	9860	Network Trunk Cable
	Industrial Ethernet	See pages 11–14	
	MODULNET	3094A	RG-11 Quad Shield PVC
		3131A	RG-6 Quad Shield PVC
PROFIBUS DP & FMS (Purple)	See Protocol listings on pages 223–224		
PROFIBUS PA (Blue)	See Protocol listings on pages 223–224		
SINEC Series H1	9907	Thin Network Trunk Cable	
	9880	Network Trunk Cable	
SINEC Series H2B	3131A	RG-6 Quad Shield	
	3094A	RG-11 Quad Shield	
SINEC Series L1	3107A	2-Pair, RS-485	
SINEC Series L2	3079A	300 V Twinax	
Thicknet Ethernet Trunk	9880	Network Trunk Cable	
	129880	Aluminum Interlocked Armor Trunk	
	139880	Steel Interlocked Armor Trunk	
Thinnet Ethernet Trunk	9907	Thin Network Trunk Cable	

CPE = Chlorinated Polyethylene
 LSNH = Low Smoke No Halogen
 FEP = Fluorinated Ethylene-propylene
 PVC = Polyvinyl Chloride

PLC/DCS Cable Cross Reference Guide (continued)

PLC/DCS Manufacturer	System Name	Belden Part Number		
Smar	FOUNDATION Fieldbus (Type SP50 ISA/IEC)	See Protocol listings on pages 223–224		
	Industrial Ethernet	See pages 251–268		
	PROFIBUS DP FMS & PA	See Protocol listings on pages 223–224		
	RS-485	See Protocol listings on pages 223–224		
Square D/ Schneider AEG	FIP/Fieldbus	3079A	22 AWG, 1-Pair, Shielded	
		123079A	Aluminum Armor (3079A)	
	Industrial Ethernet	See pages 251–268		
	Model 50, RS-422 Cable	8760	18 AWG, 1-Pair, Shielded	
		128760	Aluminum Armor (8760)	
		Passport I/O – I/O Net	3105A	22 AWG, 1-Pair, RS-485
			123105A	Aluminum Armor (3105A)
	Power Logic	3106A	22 AWG, 1.5-Pair, RS-485	
		123106A	Aluminum Armor (3106A)	
		9841	24 AWG, 1-Pair, RS-485	
Square D/ Schneider AEG	Seriplex®	9842	24 AWG, 2-Pair, RS-485	
		3124A	CBL-1822-P20	
		3125A	CBL-1622-P16	
		3126A	CBL-162212-P16	
		123124A	Aluminum Armor (3124A)	
		123125A	Aluminum Armor (3125A)	
		123126A	Aluminum Armor (3126A)	
		9463	Blue Hose® (Standard)	
		9463NH	20 AWG Twinax, FRNC	
		9463LS	20 AWG Twinax, Steel Wire Armor, FRNC	
		129463	Aluminum Armor (9463)	
		139463	Steel Armor (9463)	
		189463	Continuous Armor (9463)	
		YR28826	Dual Version (9463)	
		9463DB	Direct Burial (9463)	
		YR29565	Various Color Jackets 9463)	
		SY/Net Network Trunk Cable	3072F	600 V TC Rated (9463)
89463	FEP 200 °C, Plenum			
SY/Net TNIM Cable	9272	20 AWG, 1-Pair, Shielded		
	89272	FEP 200 °C, Plenum		

PLC/DCS Manufacturer	System Name	Belden Part Number	
Yokogawa – CENTUM	DeviceNet™	See Protocol listings on pages 223–224	
	FOUNDATION Fieldbus (Type SP50 ISA/IEC)	See Protocol listings on pages 223–224	
	HART	See Protocol listings on pages 223–224	
	Industrial Ethernet	See pages 251–268	
	PROFIBUS	See Protocol listings on pages 223–224	
	RS-485	See Protocol listings on pages 223–224	
Yokogawa – FA-M3	DeviceNet	See Protocol listings on pages 223–224	
	Industrial Ethernet	See pages 251–268	
	MODBUS	See Protocol listings on pages 223–224	
	PROFIBUS	See Protocol listings on pages 223–224	
	RS-485	See Protocol listings on pages 223–224	
	Yokogawa – STARDOM	DeviceNet	See Protocol listings on pages 223–224
FOUNDATION Fieldbus (Type SP50 ISA/IEC)		See Protocol listings on pages 223–224	
HART		See Protocol listings on pages 223–224	
Industrial Ethernet		See pages 251–268	
PROFIBUS		See Protocol listings on pages 223–224	
RS-485		See Protocol listings on pages 223–224	
Westinghouse	WDPF	9292*	RG-11 PVC

FEP = Fluorinated Ethylene-Propylene.
FRNC = Fire Retardant, Non-Corrosive
TC = Tinned Copper

ControlNet is a ControlNet International, Ltd. trademark.
DeviceNet is an Open DeviceNet Vendor Association, Inc. trademark.
EtherNet/IP is a ControlNet International, Ltd. trademark, under license by Open DeviceNet Vendor Association, Inc.
HART is a HART Communication Foundation trademark.
INTERBUS is a Phoenix Contact trademark.
MODBUS is a Schneider Electric trademark.
PROFIBUS is a PROFIBUS International trademark.
PROFINET is a PROFIBUS International trademark.
SDS is a Honeywell International, Inc. trademark.
Seriplex is a Square D/Schneider AEG trademark.

Protocol Cable Cross Reference Guide

System Name	Belden Part Number
Industrial Ethernet	See pages 251–268
FOUNDATION Fieldbus (Type SP50 ISA/IEC)	See pages 227–230
	HSE Copper See Industrial Ethernet
PROFIBUS DP	3079A 22 AWG 300 V Twinax
	3079E 22 AWG 300 V Twinax, Flex Version
	3079ALS 22 AWG, Steel Wire Armored, LSNH
	3079ANH 22 AWG, LSNH
	70101E Solid Cond., PVC, IEC 60332-1, IEC 61158-2
	70101NH Solid Cond., LSNH, IEC 60332-1, IEC 61158-2
	70101LS Solid Cond., Steel Wire Armored, LSNH, IEC 60332-1, IEC 61158-2
	70102E Stranded Cond., PVC, IEC 60332-1, IEC 61158-2
	70101PE Outdoor, PE, IEC 61158-2
	70103E Fast Connect, PVC, IEC 60332-1, IEC 61158-2
	70104E Fast Connect, PVC, UL AWM 20276
	70105PU Trailing, PUR, IEC 61158-2
	183079A 22 AWG, 300 V, Twinax, Armored
PROFIBUS PA	3076F 18 AWG, 2-Conductor, PVC, CMX-Outdoor
	3076ELS 18 AWG, 2-Conductor, LSNH Inner and Outer Jacket
	3076ENH 18 AWG, 2-Conductor, LSNH
	183076F 18 AWG, 2-Conductor, Armored, PVC
	70001E 18 AWG, 2-Conductor, PVC, IEC 60332-1
	70001NH 18 AWG, 2-Conductor, LSNH, IEC 60332-1
	70001LS 18 AWG, 2-Conductor, Steel Wire Armour, LSNH, IEC 60332-1
	70200E 18 AWG, 2-Conductor, PVC, 30 V UL AWM 2464, IEC 60332-1, IEC 61158-2
	70200NH 18 AWG, 2-Conductor, LSNH, 30 V UL AWM 20851, IEC 60332-1, IEC 61158-2
	70200LS 18 AWG, 2-Conductor, Steel Wire Armor, LSNH, IEC 60332-1, IEC 61158-2
	70110E 18 AWG, 2-Conductor, PVC, IEC 60332-1, IEC 61158-2, UL 1581, AWM 2464

System Name	Belden Part Number
CANopen RS-485/HART	9841 1-Pair
	9841NH 1-Pair, LSNH
	9841LS 1-Pair, Low Smoke
	82841 1-Pair, Plenum
	89841 1-Pair, Plenum, High-Temperature
	9842 2-Pair
	9842NH 2-Pair, LSNH
	9842LS 2-Pair, Low Smoke
	82842 2-Pair, Plenum
	9843 3-Pair
	9843NH 3-Pair, LSNH
	9844 4-Pair
	9844NH 4-Pair, LSNH
	7200A 1-Pair, RS-485, Hi-Flex
	7201A 2-Pair, RS-485, Hi-Flex
	7202A 3-Pair, RS-485, Hi-Flex
	7203A 4-Pair, RS-485, Hi-Flex
	7206A 1-Pair, RS-485, Hi-Flex
	3105A 1-Pair, RS-485 (PLTC)
	3106A 1.5-Pair, RS-485 (PLTC)
	3107A 2-Pair, RS-485 (PLTC)
	3108A 3 Pair, RS-485 (PLTC)
	3109A 4 Pair, RS-485 (PLTC)
	123107A 2-Pair, RS-485, Aluminium Interlocked Armor
DeviceBus for ODVA DeviceNet	1345F CL2 TPE (Thick)
	3082A PVC (Thick)
	3082F High-Flex (Thick)
	3083A CPE (Thick)
	3084A PVC (Thin)
	3084F High-Flex (Thin)
	3085A CPE (Thin)
	7895A CL2 PVC (Cable III Mid)
	7896A CL1 PVC (Type V Trunk Cable)
	7897A CL1 PVC (Thick)
	7900A CL1 Unshielded (Drop Cable IV)

CPE = Chlorinated Polyethylene
 PE = Polyethylene
 PUR = Polyurethane
 LSNH = Low Smoke No Halogen
 PVC = Polyvinyl Chloride
 TPE = Fluorinated Ethylene-propylene

Protocol Cable Cross Reference Guide (continued)

System Name	Belden Part Number	
DeviceBus for Honeywell Smart Distributed System (SDS)	3086A	1-Pair 16 AWG, 1-Pair 20 AWG
	3087A	2-Pair 22 AWG
DeviceBus for Square D/Seriplex	3124A	1-Pair 18 AWG, 1-Pair 22 AWG
	3125A	1-Pair 16 AWG, 1-Pair 22 AWG
	3126A	1-Pair 16 AWG, 1-Pair 22 AWG, 1-Pair 12 AWG
	123124A	Aluminum Armor (3124A)
	123125A	Aluminum Armor (3125A)
	123126A	Aluminum Armor (3126A)
DeviceBus for Phoenix Contact INTERBUS-S	3119A	18 AWG/3c, 24 AWG/3-Pair, Composite
	3120A	24 AWG/3-Pair
ControlNet™	3092A	RG-6 PVC Quad Shield
	3092F	RG-6 PVC Quad Shield, Flex Version, Aluminum Braid
	3093A	RG-6 FEP Quad Shield, Plenum
	123092A	Aluminum Armor (3092A)
	133092A	Steel Armor (3092A)
	183092A	Continuous Armor (3092A)
	ControlBus	3092F
3131A		RG-6 Quad Shield, Solid
3132A		RG-6 Quad Shield, Plenum, Outdoor and Direct Burial
3094A		RG-11 Quad Shield, Solid
3095A		RG-11 Quad Shield, Plenum, Outdoor and Direct Burial
ControlBus Blue Hose Industrial Twinax/DataHighway (DH) and DataHighway Plus (DH+) Remote I/O	9463	20 AWG Twinax, Blue Hose
	9463DB	Direct Burial Blue Hose
	9463NH	20 AWG Twinax, FRNC
	9463LS	20 AWG Twinax Steel Wire Armor, FRNC
	9463F	High-Flex, Blue Hose
	89463	High-Temp, Plenum Blue Hose
	129463	Aluminum Armor (9463)
	139463	Steel Armor (9463)
	189463	Continuous Armor (9463)

System Name	Belden Part Number		
ControlBus Twinax Cables	9272	20 AWG Stranded, 300 V	
	9250	18 AWG Stranded, RG-22B	
	9207	20 AWG Stranded, PVC	
	9207NH	20 AWG Stranded, LSNH	
	9271	25 AWG Stranded, 300 V	
	9860	16 AWG Solid, PVC	
	9182	22 AWG Stranded, PVC	
	9182NH	22 AWG Stranded, LSNH	
	9182LS	22 AWG Stranded, Steel Wire Armor, LSNH	
	89182	22 AWG Stranded, Plenum, FEP	
MODBUS RS-232	8777	22 AWG, 3-Pair, Modem Drop Cable	
	128777	Aluminum Armor (8777)	
	138777	Steel Armor (8777)	
	82777	FEP 200 °C, Plenum (8777)	
	8777NH	22 AWG, 3-Pair, LSNH	
	8777LS	22 AWG, 3-Pair, Steel Wire Armor	
MODBUS II RG-6 Type Coaxial Cables	3092A	18 AWG Solid, PVC	
	3093A	18 AWG Solid, Plenum	
	3092F	20 AWG High Flex	
LonWorks	7701NH	22 AWG, 1-Pair, LSNH	
	7702NH	22 AWG, 2-Pair, LSNH	
	7703NH	24 AWG, 1-Pair, LSNH	
	7704NH	24 AWG, 2-Pair, LSNH	
	8471	16 AWG, 1-Pair, UL AWM 2598	
	8471LS	16 AWG, 1-Pair, LSNH, IEC 60332-1	
	8471NH	16 AWG 1-Pair, LSNH	
	85102	16 AWG, 1-Pair, Tefzel® jacket	
DataTray 600 V Twinaxial	3072F	18 AWG, MSHA, 78 Ω, PVC	
	3073F	18 AWG, 100 Ω, PVC	
	3074F	18 AWG, 124 Ω, PVC	
	CC Link	7953A	Cat 6, 600 V UL AWM, EtherNet/IP, CMX-Outdoor, Solid, LSNH
7929A		Cat 5e, MSHA, CMX-Outdoor, Solid, PVC	
7921A		Cat 5e, EtherNet/IP, CMX-Outdoor, Solid, PVC	
7939A		Cat 5e, CMX-Outdoor, Stranded, PVC	
1348A		3-Conductor, PVC Outer Jacket	
1349A		5-Conductor, PVC Inner and Outer Jacket	
KNX/EIB		YE00819	1-pair, PVC
		YE00820	2-pair, PVC
	YE00905	1-pair, LSNH	
	YE00906	2-pair, LSNH	
Coaxial Ethernet	9907	20 AWG, Stranded, PVC	
	89907	20 AWG, Stranded, Plenum	
	9880	12 AWG, Solid, PVC	
	89880	12 AWG, Solid, Plenum	

CPE = Chlorinated Polyethylene
 FEP = Fluorinated Ethylene
 FRPO = Flame Retardant Polyolefin
 FRNC = Fire Retardant, Non-Corrosive
 LSNH = Low Smoke No Halogen
 PVC = Polyvinyl Chloride
 TPE = Fluorinated Ethylene-propylene
 MSHA = Mine Safety and Health Administration

Industrial Data and Process Automation Serial Fieldbus



Section Table of Contents

Industrial Data and Process Automation	
Serial Fieldbus	
Overview	226
Foundation Fieldbus Type A	227–229
Foundation Fieldbus Type B	230
PROFIBUS	231–232
CANopen RS-485	233–234
DeviceBus® for ODVA DeviceNet™	235–236
DeviceBus® for Honeywell Smart Distributed System	237
DeviceBus® for Square D/Seriplex® and Phoenix Contact INTERBUS®-S	238
ControlNet™	239
ControlBus™	240–242
MODBUS for RS-232 Applications	243
MODBUS II for RG-6 Type Coaxial Cables	243
LonWorks	244
DataTray® 600 V Twinaxial	245
CC Link	246
KNX/EIB Approved Cables	247
Coaxial Ethernet	248
MachFlex Flexible Automation Cables	249
300 V MachFlex Data Cables (1 Million Flex Cycles)	249
MachFlex Vision 75 Ohm Coax Cables (1 Million Flex Cycles)	249



Serial Fieldbus



Today, more than ever, manufacturing productivity depends upon seamless data communication and automation systems. And both depend upon high-performance cabling solutions. The Serial Fieldbus range covers all key protocols in the market: Foundation Fieldbus (type A, type B, high speed), Profibus DP and PA, CanOpen RS-485, DeviceBus (for ODVA DeviceNet™, Honeywell Smart Distributed System, Square D/Seriplex® and Phoenix Contact INTERBUS®-S), ControlNet, ControlBus, MODBUS, Lonworks, DataTray® 600 V Twinaxial, CC Link, KNX/EIB and Coaxial Ethernet. The products are approved for the main PCL/DCS manufacturers in the market, such as: ABB, Siemens, Rockwell Automation, Honeywell, Emerson, Yokogawa, Mitsubishi, Schneider Electric, Omron, etc.

Product Features

- Variety of jacket materials: PVC, CPE, HDPE, FRNC/LSNH, or TPE jackets
- Versions available with Beldfoil® shields and Beldfoil® Plus Braid shields
- Twisted and bonded pairs, quad, single and multi-conductor versions
- Operation temperature from -40 °C up to +150 °C, designs suitable for hi/lo temperature installations
- UL, IEC, NFPA approvals
- Sunlight, oil, gasoline and weldsplatter resistant designs
- Suitable for CMX/outdoor applications
- PLTC listed cables
- High resistance against trailing and torsion as well continuous flooding
- Options suitable for direct burial

Benefits

- Robustness for full range of industrial applications: outdoors, trailing, oil contact
- Reliability through design robustness: steel wire armor, aluminium interlock armor, stranded conductors
- Ease of use through fast connect versions

Applications

Belden has developed the world's most comprehensive line of industrial cabling solutions for applications like yours: whether you are networking your factory floor or your process equipment and devices to their controllers, on to the control room, or relaying data between the control room, the engineering department, and remote manufacturing sites. From your petrochemical, automotive manufacturing, pharmaceutical, power generation, pulp and paper, metals, food and beverage, or general manufacturing plant to your corporate headquarters – and everywhere in between – Belden has your cabling solution.

Foundation Fieldbus Type A

Foundation Fieldbus Type A

- Impedance 100 Ohm



Part No.	AWG	Voltage	Pairs	OD (Nom)		Operating Temperature (°C)	Additional Features/Ratings
				Inch	mm		
Stranded (7 x 26) TC Conductors • Polyolefin Insulation • TC Drain Wire • Beldfoil® Shielding • Orange or Intrinsically Safe Blue PVC Jacket							
3076F*	18	300	1	.253	6.43	-40 to +105	PLTC/ITC-ER CMG CMX-Outdoor CEC: CMG FT4 Sunlight Res Oil Res IEC 60332-3-24 (Cat C)
Stranded (7 x 26) TC Conductors • Polyolefin Insulation • TC Drain Wire • Beldfoil® Shielding • LSNH Inner Jacket (Black and Blue) • Steel Wire Armour • Black LSNH Outer Jacket							
3076ELS	18	300	1	.295/.511	7.5/13	-45 to +80	NEC: CM • CEC: CM
Stranded (7 x 26) TC Conductors • Polyolefin Insulation • TC Drain Wire • Beldfoil® Shielding • LSNH Jacket							
3076ENH	18	300	1	.295	7.5	-45 to +80	NEC: CM • CEC: CM
Stranded (7 x 26) TC Conductors • Polyolefin Insulation • TC Drain Wire • Beldfoil® Shielding • PVC Inner Jacket • Armor • Orange PVC Outer Jacket							
183076F	18	300	1	.562	14.30	-40 to +105	FOUNDATION Fieldbus Type A Continuously Corrugated Aluminum Armor NEC: CMX-Outdoor Sunlight Res Oil Res
Stranded (7 x 26) TC Conductors • Polyolefin Insulation • TC Drain Wire • Individually Foil Shielded Pairs + Overall Beldfoil® Shielding • Orange PVC Jacket							
1327A	18	300	2	.44	11.18	-40 to +105	PLTC/ITC-ER CMG CMX-Outdoor CEC: CMG FT4 Sunlight Res Oil Res IEC 60332-3-24 (Cat C)
1328A			5	.55	13.87		
1329A			8	.67	17.02		
1330A			12	.81	20.57		
1331A			16	.92	23.37		
1332A			20	1.02	25.91		
1333A			24	1.14	28.96		
1359A			50	1.61	40.90		
Stranded (7 x 26) TC Conductors • Polyolefin Insulation • TC Drain Wire • Beldfoil® + 65% TC Braid Shielding • Orange or Intrinsically Safe Blue PVC Jacket							
1334A	18	300	1	.28	7.11	-50 to +105	PLTC/ITC-ER CMG CMX-Outdoor CEC: CMG FT4 Sunlight Res Oil Res IEC 60332-3-24 (Cat C)

* ABS and DNV-GL approved design also available. For more details please see Belden MarineTuff Offshore and Marine Cable Solutions brochure or consult Customer Service.

Conductor Color Code: Blue, Orange, Numbered Pairs

TC = Tinned Copper • PVC = Polyvinyl Chloride • LSNH = Low Smoke No Halogen

Foundation Fieldbus Type A

Foundation Fieldbus Type A

- Impedance 100 Ohm



Part No.	AWG	Voltage	Pairs	OD (Nom)		Operating Temperature (°C)	Additional Features/Ratings
				Inch	mm		
Stranded (7 x 26) TC Conductors • Cross-Linked Polyolefin Insulation • TC Drain Wire • Individually Shielded Pairs and Overall Beldfoil® Shielding • Orange or Intrinsically Safe Blue PVC Jacket							
2100A			1	.319	8.10		
2101A			2	.512	13.00		
2102A			5	.677	17.20		PLTC/ITC-ER CMG
2103A			8	.800	20.32		CMX-Outdoor CEC: CMG FT4
2104A	18	300	12	1.015	25.78	-55 to +90	C(UL) CIC Type TC Sunlight Res Oil Res
2105A			16	1.126	28.60		IEC 60332-3-24 (Cat C)
2106A			20	1.249	31.72		
2107A			24	1.389	35.28		
2108A			50	1.947	49.45		
Stranded (7 x 26) TC Conductors • Cross-Linked Polyolefin Insulation • TC Drain Wires • Individually Shielded Pairs and Overall Beldfoil® Shielding • Orange or Intrinsically Safe Blue PVC Jacket							
2118A*			1	.319	8.10		
2119A*			2	.512	13.00		
2120A*			5	.677	17.20		TC-ER CMG
2121A*			8	.800	20.32		CMX-Outdoor CEC: CMG FT4
2122A*	18	600	12	1.015	25.78	-55 to +90	C(UL) CIC Type TC Sunlight Res Oil Res
2123A			16	1.126	28.60		IEC 60332-3-24 (Cat C)
2124A			20	1.249	31.72		
2125A			24	1.389	35.28		
2126A			50	1.947	49.45		
Stranded (7 x 24) TC Conductors • Polyolefin Insulation • TC Drain Wires • Individually Shielded Pairs and Overall Beldfoil® Shielding • Orange PVC Jacket							
1360A			1	.40	10.16	-50 to +105	
1361A			2	.58	14.73		
1362A			5	.75	19.05		PLTC/ITC-ER CMG
1363A			8	.91	23.11		CMX-Outdoor CEC: CMG FT4
1364A	16	300	12	1.11	28.19	-40 to +105	Sunlight Res Oil Res
1365A			16	1.23	31.24		IEC 60332-3-24 (Cat C)
1366A			20	1.39	35.31		
1367A			24	1.55	39.37		
Stranded (7 x 24) TC Conductors • Cross-Linked Polyolefin Insulation • TC Drain Wire • Individually Shielded Pairs and Overall Beldfoil® Shielding • Orange or Intrinsically Safe Blue PVC Jacket							
2109A			1	.365	9.27		
2110A			2	.629	15.98		
2111A			5	.789	20.04		PLTC/ITC-ER CMG
2112A			8	.982	24.94		CMX-Outdoor CEC: CMG FT4
2113A	16	300	12	1.186	30.12	-55 to +90	C(UL) CIC Type TC Sunlight Res Oil Res
2114A			16	1.321	33.55		IEC 60332-3-24 (Cat C)
2115A			20	1.469	37.31		
2116A			24	1.638	41.61		
2117A			36	1.952	49.58		

* ABS and DNV-GL approved design also available. For more details please see Belden MarineTuff Offshore and Marine Cable Solutions brochure or consult Customer Service.

Conductor Color Code: Blue, Orange, Numbered Pairs

TC = Tinned Copper • PVC = Polyvinyl Chloride

Foundation Fieldbus Type A

Foundation Fieldbus Type A

- Impedance 100 Ohm



Part No.	AWG	Voltage	Pairs	OD (Nom)		Operating Temperature (°C)	Additional Features/Ratings
				Inch	mm		
Stranded (7 x 24) TC Conductors • Cross-Linked Polyolefin Insulation • TC Drain Wire • Individually Shielded Pairs and Overall Beldfoil® Shielding • Orange or Intrinsically Safe Blue PVC Jacket							
2127A*			1	.365	9.27		
2128A*			2	.629	15.98		
2129A*			5	.789	20.04		
2130A*			8	.982	24.94		TC-ER CMG
2131A*	16	600	12	1.186	30.12	-55 to +90	CMX-Outdoor CEC: CMG FT4 C(UL) CIC Type TC
2132A			16	1.321	33.55		Sunlight Res Oil Res
2133A			20	1.469	37.31		IEC 60332-3-24 (Cat C)
2134A			24	1.638	41.61		
2135A			36	1.952	49.58		
Stranded (7 x 24) TC Conductors • Polyolefin Insulation • TC Drain Wire • Overall Beldfoil® + 65% TC Braid Shielding • Orange or Intrinsically Safe Blue PVC Jacket							
1335A**	16	300	1	.34	8.64	-50 to +105	PLTC/ITC-ER CMG CMX-Outdoor CEC: CMG FT4 Sunlight Res Oil Res IEC 60332-3-24 (Cat C)
Stranded (7 x 22) TC Conductors • Polyolefin Insulation • TC Drain Wire • Overall Beldfoil® + 65% TC Braid Shielding • Orange or Intrinsically Safe Blue PVC Jacket							
1336A**	14	300	1	.43	10.92	-50 to +105	PLTC/ITC-ER CMG CMX-Outdoor CEC: CMG FT4 Sunlight Res Oil Res IEC 60332-3-24 (Cat C)

* ABS and DNV-GL approved design also available. For more details please see Belden MarineTuff Offshore and Marine Cable Solutions brochure or consult Customer Service.

** Although Type A specification references nominal 18 AWG, Belden 1335A and 1336A meet all other Type A requirements.

Conductor Color Code: Blue, Orange, Numbered Pairs

Foundation Fieldbus Type B

Foundation Fieldbus Type B and High Speed

- Impedance 100 Ohm or 150 Ohm



Part No.	Impedance (Ohm)	AWG	Voltage	Pairs	OD (Nom)		Operating Temperature (°C)	Additional Features/Ratings
					Inch	mm		
Stranded (7 x 30) TC Conductors • Polyolefin Insulation • TC Drain Wire • Beldfoil® Shielding • Orange PVC Jacket								
3077F	100	22	300	1	.196	4.97	-30 to +105	FOUNDATION Fieldbus Type B NEC: PLTC/ITC CM • CEC: CM FT1 Sunlight Res Oil Res
Stranded (7 x 30) TC Conductors • Foam High-Density Polyethylene Insulation • TC Drain Wire • Beldfoil® Shield • Orange PVC Jacket								
3078F	150	22	300	1	.351	8.92	-40 to +75	FOUNDATION Fieldbus High Speed NEC: CM • CEC: CM Sunlight Res Oil Res
Stranded (7 x 30) TC Conductors • Polyolefin Insulation • TC Drain Wire • Beldfoil® Shielding • Steel Wire Armour • FRNC Jacket								
3077ELS	100	22	300	1	.295/.512*	7.50/13.00*	-30 to +105	FOUNDATION Fieldbus Type B NEC: PLTC/ITC CM • CEC: CM FT1
Stranded (7 x 30) TC Conductors • Polyolefin Insulation • TC Drain Wire • Beldfoil® Shielding • FRNC Jacket								
3077ENH	100	22	300	1	.295	7.50	-30 to +105	FOUNDATION Fieldbus Type B NEC: PLTC/ITC CM • CEC: CM FT1

* Inner jacket/outer jacket

Conductor Color Code: Blue, Orange

PROFIBUS

PROFIBUS PA

- Impedance 150 Ohm
- 300 V



Part No.	Shielding	Jacket	OD (Nom)		Operating Temperature (°C)	Additional Features
			Inch	mm		
18 AWG (.891 mm²) • Stranded (7 x 26) TC Conductors • 1 Pair • Polyolefin Insulation						
3076F	Overall Beldfoil®	PVC	.253	6.43	-40 to +105	PLTC/ITC-ER CMG CMX-Outdoor CEC: CMG FT4 Sunlight Res Oil Res IEC 60332-3-24 (Cat C)
70200E			.295	7.5	-40 to +80	30 V UL AWM 2464 IEC 60332-1 • IEC 61158-2
70001E	Overall Beldfoil® + 85% Braid		.295	7.5	-45 to +80	30 V UL AWM 20276 IEC 60332-1
70110E	Overall Beldfoil® + >70% Braid		.307	7.8	-30 to +75	IEC 60332-1 • IEC 61158-2 UL 1581 • 30 V UL AWM 2464
3076ENH					-45 to +80	NEC: CM • CEC: CM
70200NH	Overall Beldfoil®	LSNH	.295	7.5	-40 to +80	30 V UL AWM 20851 IEC 60332-1 • IEC 61158-2
70001NH	Overall Beldfoil® + 85% Braid					-45 to +80
18 AWG (.891 mm²) • Stranded (7 x 26) TC Conductors • 1 Pair • Polyolefin Insulation • Continuously Corrugated Aluminium Armor						
183076F	Overall Beldfoil® + 65% Braid	PVC	.253/.562	6.43/14.3	-40 to +105	FOUNDATION Fieldbus Type A Continuously Corrugated Aluminum Armor NEC: CMX-Outdoor Sunlight Res Oil Res PVC Inner Jacket
18 AWG (.891 mm²) • Stranded (7 x 26) TC Conductors • 1 Pair • Polyolefin Insulation • Steel Wire Armor						
3076ELS					-45 to +80	Steel Wire Armor NEC: CM • CEC: CM LSNH Inner Jacket
	Overall Beldfoil®					
70200LS		LSNH	.295/.511	7.5/13	-40 to +70	Steel Wire Armor IEC 60332-1 • IEC 61158-2 LSNH Inner Jacket
70001LS	Overall Beldfoil® + 85% Braid				-45 to +70	Steel Wire Armor IEC 60332-1 LSNH Inner Jacket

Conductor Color Coding: 3076F, 3076ELS, 3076ENH, 183076F: Blue, Orange
70001E, 70001NH, 70001LS, 70200E, 70200NH, 70200LS, 70110E: Red, Green

All construction have TC Drain Wire in their design.
Colors available: Orange, Blue, Black

TC = Tinned Copper • PVC = Polyvinyl Chloride • LSNH = Low Smoke No Halogen

PROFIBUS

PROFIBUS DP



- Impedance 150 Ohm
- 300 V

Part No.	Shielding	Jacket	OD (Nom)		Operating Temperature (°C)	Additional Features
			Inch	mm		
22 AWG (.322 mm²) • Solid BC Conductors • 1 Pair • Flame Retardant Foam Polyethylene Insulation						
3079A*			.315	8.92	-30 to +75	NEC: CMG • CEC: CMG FT4 UL PLTC Sunlight Res Siemens Sinec L2 cable UL AWM 20201 (600 V, +75 °C)
70101E	Overall Beldfoil® + 65% Braid	PVC	.307	7.8	-40 to +80	30 V UL AWM 20276 IEC 60332-1 • IEC 61158-2
70103E			.323	8.2	-40 to +80	Fast Connect 30 V UL AWM 20276 IEC 60332-1 • IEC 61158-2
3079ANH			.315	8.0	-45 to +80	IEC 60332-3-24
70101NH		LSNH	.307	7.8	-40 to +80	30 V UL AWM 20851 IEC 60332-1 • IEC 61158-2
70101PE		PE	.307	7.8	-40 to +70	Outdoor IEC 61158-2
22 AWG (.352 mm²) • Stranded (7 x 30) BC Conductors • 1 Pair • Flame Retardant Foam Polyethylene Insulation						
3079E	Overall Beldfoil® + 65% Braid	PVC	.315	8.92	-30 to +75	NEC: CMG • CEC: CMG FT4 UL PLTC Sunlight Res UL AWM 20201 (600 V, +75 °C)
70102E			.307	7.8	-40 to +80	30 V UL AWM 20276 IEC 60332-1 • IEC 61158-2
24 AWG (.239 mm²) • Stranded (19 x 36) BC Conductors • 1 Pair • Flame Retardant Foam Polyethylene Insulation						
70105PU	Overall Beldfoil® + 70% Braid	PUR	.307	7.8	-40 to +80	2 Million Continuous Flex Cycles, Trailing 30 V UL AWM 21292 IEC 61158-2
22 AWG (.322 mm²) • Solid BC Conductors • 1 Pair • Flame Retardant Foam Polyethylene Insulation • Continuously Corrugated Aluminium Armor						
183079A	Overall Beldfoil® + 65% Braid	PVC	.315/.587	8.92/14.91	-30 to +60	NEC: CMG • CEC: CMG FT4 UL PLTC Continuously Corrugated Aluminum Armor 600 V AWM Sunlight Res PVC Inner Jacket
22 AWG (.322 mm²) • Solid BC Conductors • 1 Pair • Flame Retardant Foam Polyethylene Insulation • Steel Wire Armor						
3079ALS	Overall Beldfoil® + 65% Braid		.315/.488	8.00/12.40	-45 to +80	Steel Wire Armor IEC 60332-3-24 LSNH Inner Jacket
70101LS		LSNH	.307/.472	7.8/12	-40 to +70	Steel Wire Armor IEC 60332-1 • IEC 61158-2 LSNH Inner Jacket

* ABS and DNV-GL approved design also available. For more details please see Belden MarineTuff Offshore and Marine Cable Solutions brochure or consult Customer Service.

Conductor Color Coding: Red, Green

All construction have TC Drain Wire in their design.
Colors available: Chrome, Purple, Black

CANopen RS-485

Non-Plenum • Overall Foil/
Braid Shield • RS-485 • DMX512

- Impedance 120 Ohm



Part No.	Pairs	Color Code	OD (Nom)		Insulation Thickness		Jacket Thickness		Capacitance				Additional Features/Ratings
			Inch	mm	Inch	mm	Inch	mm	Cond. - Cond.		Cond. - Shield		
									pF/Ft	pF/m	pF/Ft	pF/m	

24 AWG • Polyethylene/PVC

Stranded (7 x 32) TC Conductors • Polyethylene Insulation • Overall Beldfoil® + 90% TC Braid Shield • 24 AWG Stranded TC Drain Wire • Chrome PVC Jacket													
9841	1	Chart 5	.232	5.89	.023	.58	.035	.89					NEC: CM • CEC: CM UL AWM Style 2919 (30 V, +80 °C) ANSI E1.11 DMX512 120 Ω Nom. Impedance 66% Velocity of Prop. Conductor DCR (Nom): 24.0 Ω/1000' (78.7 Ω/km)
9842	2	Chart 5	.340	8.64					12.8	42.0	23.0	75.5	
9843	3	Chart 5	.360	9.14	.022	.56	.035	.89					
9844	4	Chart 5	.390	9.91									

24 AWG • Polyethylene/LSNH

Stranded (7 x 32) TC Conductors • Polyethylene Insulation • Overall Beldfoil® + 90% TC Braid Shield • 24 AWG Stranded TC Drain Wire • Chrome FRNC/LSNH Jacket													
9841NH	1	Chart 5	.232	5.89	.023	0.58	.035	.89					IEC332-3-24 ANSI E1.11 DMX512 120 Ω Nom. Impedance 66% Velocity of Prop. Conductor DCR (Nom): 24.0 Ω/1000' (78.7 Ω/km)
9842NH	2	Chart 5	.341	8.65					12.8	42.0	23.0	75.5	
9843NH	3	Chart 5	.358	9.10	.022	0.56	.035	.89					
9844NH	4	Chart 5	.390	9.91									

24 AWG • Polyethylene/LSNH • Armored

Stranded (7 x 32) TC Conductors • Polyethylene Insulation • Chrome FRNC/LSNH Inner Jacket • Overall Beldfoil® + 90% TC Braid Shield • 24 AWG Stranded TC Drain Wire • Steel Wire Armor • Black Sunlight-Resistant FRNC/LSNH Outer Jacket														
9841LS	1	Chart 5	.405	10.30	.023	0.58							IEC332-3-24 ANSI E1.11 DMX512 120 Ω Nom. Impedance 66% Velocity of Prop. Conductor DCR (Nom): 24.0 Ω/1000' (78.7 Ω/km)	
9842LS	2	Chart 5	.516	13.10	.022	0.56			.035/.051*	.89/1.30*	12.8	42.0		23.0

* Inner jacket/outer jacket

Plenum • Overall Foil/
Braid Shield • RS-485

- Impedance 120 Ohm

- NEC: CMP
- CEC: CMP FT6



Part No.	Pairs	Color Code	OD (Nom)		Insulation Thickness		Jacket Thickness		Capacitance				Additional Features/Ratings
			Inch	mm	Inch	mm	Inch	mm	Cond. - Cond.		Cond. - Shield		
									pF/Ft	pF/m	pF/Ft	pF/m	

24 AWG • FEP/Flamarrest®

Stranded (7 x 32) TC Conductors • Foam FEP Insulation • Overall Beldfoil® + 90% TC Braid Shield • 24 AWG Stranded TC Drain Wire • Natural Flamarrest Jacket													
82841	1	Chart 5	.204	5.18	.025	.64	.015	.38					Plenum 300 V 120 Ω Nom. Impedance 76% Velocity of Prop. Conductor DCR (Nom): 24.0 Ω/1000' (78.7 Ω/km)
82842	2	Chart 5	.273	6.93	.019	.48	.015	.38	12	39.4	22	72.2	

24 AWG • FEP/FEP

Stranded (7 x 32) TC Conductors • Foam FEP Insulation • Overall Beldfoil® + 90% TC Braid Shield • 24 AWG Stranded TC Drain Wire • Red FEP Jacket													
89841	1	Chart 5	.202	5.13	.025	.64	.014	.36					Plenum 300 V 120 Ω Nom. Impedance 76% Velocity of Prop. Conductor DCR (Nom): 24.0 Ω/1000' (78.7 Ω/km)
89842	2	Chart 5	.305	7.75	.023	.58	.014	.36	12	39.4	22	72.2	

TC = Tinned Copper • FEP = Fluorinated Ethylene Propylene • FRNC/LSNH = Fire Retardant, Non-Corrosive/Low Smoke, No Halogen | Belden Color Code Charts can be found at page 344.

CANopen RS-485

Paired Cable • Shielded

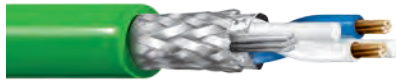

- 24 AWG (41 x 40) BC Conductors
- Foam Polyethylene Insulation with Skin
- Overall Beldfoil® + 85% TC Braid Shield
- Green PVC Jacket
- 24 AWG (41 x 40) TC Drain Wire
- Impedance 120 Ohm
- NEC: CM
- CEC: CM
- -20 °C to +60 °C
- -5 °C to +60 °C Flexing

Part No.	Pairs	OD (Nom)		Capacitance (Max) Cond.-Cond.		Additional Features/Ratings
		Inch	mm	pF/Ft	pF/m	

120 Ohm Impedance • RS-232 and RS-485

24 AWG (41 x 40) BC Conductors • Foam Polyethylene Insulation with Skin • Overall Beldfoil® + 85% TC Braid Shield • 24 AWG (41 x 40) TC Drain Wire • Green PVC Jacket						
7200A	1	.240	6.10			
7201A	2	.322	8.18	15.0	49.2	Oil Res II
7202A	3	.347	8.81			
7203A	4	.362	9.20			

Conductor Color Coding: One-Pair Cable: White, Blue
 Multi-Pair Configurations: 1 White/Blue Stripe – Blue/White Stripe
 2 White/Orange Stripe – Orange/White Stripe
 3 White/Green Stripe – Green/White Stripe
 4 White/Brown Stripe – Brown/White Stripe

PLTC Cable



- Impedance 120 Ohm

Part No.	Pairs	OD (Nom)		Capacitance (Max) Cond.-Cond.		Operating Temperature (°C)	Additional Features/Ratings
		Inch	mm	pF/Ft	pF/m		

22 AWG (7 x 30) Stranded TC Conductors • Datalene® Insulation • TC Drain Wire • Overall Beldfoil® + 90% TC Braid Shielding • Black PVC Jacket							
3105A	1.0	.284	7.21				NEC CM • CEC CM FT1
3106A*	1.5	.300	7.62				UL PLTC
3107A*	2.0	.356	9.04				Sunlight Res
3108A*	3.0	.420	10.67	11	36.1	-20 to +60	Oil Res II
3109A*	4.0	.448	11.38				300 V

3105A and 3107A are DMX512 Type
 3106A: Single conductor is under the braid shield; pair is under the Beldfoil® shield
 Also available with CPE jacket

22 AWG (7 x 30) Stranded TC Conductors • Datalene Insulation • TC Drain Wire • Overall Beldfoil® + 90% TC Braid Shielding • Armor • Black PVC Jacket							
123107A	2.0	.650	16.51	11	36.1	-40 to +60	Aluminum Interlocked Armor NEC CM • CEC CMG FT4 UL PLTC Sunlight Res Oil Res II 300 V

* ABS and DNV-GL approved design also available. For more details please see Belden MarineTuff Offshore and Marine Cable Solutions brochure or consult Customer Service.

DeviceBus® for ODVA DeviceNet™

DeviceNet Communications Rate Table (Impedance 120 Ohm)

Communications Rate (Kb/s)	Maximum Distance							
	3082A, 3082F, 3083A, 7897A		3082K, 7896A		7895A		3084F, 3084A, 3085A, 7900A	
	Feet	Meters	Feet	Meters	Feet	Meters	Feet	Meters
125	1640	500	1378	420	984	300	328	100
250	820	250	656	200	820	250	328	100
500	328	100	246	75	328	100	328	100

DeviceBus Cables

- Impedance 120 Ohm



Part No.	Pairs	OD (Nom)		Operating Temperature (°C)	Additional Features/Ratings
		Inch	mm		
15 (19 x 28) and 18 (19 x 30) AWG Stranded TC Conductors • FEP (Data), PVC/Nylon (Power) Insulation • Individually Foil Shielded Pairs + Overall 65% TC Braid Shielding • Gray PVC Jacket					
7897A	2 1 pair data 1 pair power	.460	11.7	-20 to +75	ODVA Class 1 Thick, High Velocity, 600 V UL TC-ER Sunlight Res Oil Res
16 (19 x 29) and 18 (19 x 30) AWG Stranded TC Conductors • FR Polypropylene (Data), PVC/Nylon (Power) Insulation • Individually Foil Shielded Pairs + Overall 65% TC Braid Shielding • Gray PVC Jacket					
7896A*	2 1 pair data 1 pair power	.525	13.34	-20 to +75	ODVA Class 1 Cable V, 600 V UL TC-ER Sunlight Res Oil Res
16 (19 x 29) and 18 (19 x 30) AWG Stranded TC Conductors • FR Polypropylene (Data), PVC/Nylon (Power) Insulation • Unshielded • Gray PVC Jacket					
7900A	2 1 pair data 1 pair power	.430	10.92	-20 to +75	ODVA Class 1 Cable IV, Drop Cable, 600 V UL TC-ER CEC: FT1 Sunlight Res Oil Res
15 (19 x 28) and 18 (19 x 30) AWG Stranded TC Conductors • Foam Polyethylene (Data), PVC (Power) Insulation • Individually Foil Shielded Pairs + Overall 65% TC Braid Shielding • Gray or Red PVC Jacket					
3082A	2 1 pair data 1 pair power	.480	12.19	-20 to +75	ODVA Class 2 Thick, 300 V NEC: CMG • CEC: CMG FT4 C(UL) AWM I/II A UL AWM 20201 (600 V) UL PLTC-ER Sunlight Res Oil Res
15 (65 x 33) and 18 (65 x 36) AWG Stranded TC Conductors • Foam Polyethylene (Data), PVC (Power) Insulation • Individually Foil Shielded Pairs + Overall 65% TC Braid Shielding • Gray or Red PVC Jacket					
3082F	2 1 pair data 1 pair power	.480	12.19	-20 to +75	ODVA Class 2 Thick, 300 V High Flex NEC: CMG • CEC: CMG FT4 C(UL) AWM I/II A UL AWM 20201 (600 V) UL PLTC-ER Sunlight Res Oil Res

* ABS and DNV-GL approved design also available. For more details please see Belden MarineTuff Offshore and Marine Cable Solutions brochure or consult Customer Service.

Conductor Color Coding: Data: Blue, White
Power: Red, Black

TC = Tinned Copper • FEP = Fluorinated Ethylene Propylene • PVC = Polyvinyl Chloride

DeviceBus® for ODVA DeviceNet™

DeviceBus Cables

- Impedance 120 Ohm



Part No.	Pairs	OD (Nom)		Operating Temperature (°C)	Additional Features/Ratings
		Inch	mm		
15 (65 x 33) and 18 (65 x 36) AWG Stranded TC Conductors • Foam Polyethylene (Data), PVC (Power) Insulation • Individually Foil Shielded Pairs + Overall 65% TC Braid Shielding • Gray TPE Jacket					
1345F	2 1 pair data 1 pair power	.480	12.19	-30 to +75	ODVA Class 2 Thick, 300 V High Flex NEC: CMG • CEC: CMG FT4 C(UL) AWM I/II A UL AWM 20201 (600 V) Sunlight Res Weldsplatter Resistant Oil Res I UL PLTC-ER Sunlight Res Oil Res
22 AWG (154 x 44) and 24 AWG (105 x 44) Stranded TC Conductors • Foam Polyethylene (Data), PVC (Power) Insulation • TC Drain Wire • Individual Beldfoil® + 65% TC Braid Shielding • Gray TPE Jacket					
1346F	2 1 pair data 1 pair power	.275	6.99	-30 to +75	Class 2 Thin, 300 V NEC: CMG CL2 • CEC: CMG FT4 Sunlight Res Oil Res I Weldsplatter Resistant C(UL) AWM I/II A
15 (19 x 28) and 18 (19 x 30) AWG Stranded TC Conductors • Foam Polyethylene (Data), PVC (Power) Insulation • Individually Foil Shielded Pairs + Overall 65% TC Braid Shielding • Yellow CPE Jacket					
3083A	2 1 pair data 1 pair power	.475	12.07	-30 to +75	ODVA Class 2 Thick, 300 V NEC: CMG • CEC: CMG FT4 UL PLTC Sunlight Res Oil Res
22 (19 x 34) and 24 (19 x 36) AWG Stranded TC Conductors • Foam Polyethylene (Data), PVC (Power) Insulation • Individually Foil Shielded Pairs + Overall 65% TC Braid Shielding • Gray PVC Jacket					
3084A	2 1 pair data 1 pair power	.280	7.11	-20 to +75	ODVA Class 2 Thin, 300 V NEC: CMG CL2 • CEC: CMG FT4, C(UL) AWM I/II A Sunlight Res Oil Res
22 (155 x 44) and 24 (105 x 44) AWG Stranded TC Conductors • Foam Polyethylene (Data), PVC (Power) Insulation • Individually Foil Shielded Pairs + Overall 65% TC Braid Shielding • Gray PVC Jacket					
3084F	2 1 pair data 1 pair power	.275	6.00	-20 to +75	Class 2 Thin, 300 V High Flex NEC: CMG CL2 • CEC: CMG FT4, C(UL) AWM I/II A Sunlight Res Oil Res
22 (19 x 34) and 24 (19 x 36) AWG Stranded TC Conductors • Foam Polyethylene (Data), PVC (Power) Insulation • Individually Foil Shielded Pairs + Overall 65% TC Braid Shielding • Yellow CPE Jacket					
3085A	2 1 pair data 1 pair power	.280	7.11	-30 to +75	ODVA Class 2 Thin, 300 V NEC: CL2 CMG • CEC: CMG FT4 Sunlight Res Oil Res
20 (19 x 32) and 18 AWG (19 x 30) Stranded TC Conductors • Foam Polyethylene (Data), PVC (Power) Insulation • Individually Foil Shielded Pairs + Overall 65% TC Braid Shielding • Gray PVC Jacket					
7895A	2 1 pair data 1 pair power	.378	9.60	-20 to +75	OVDA Class 2 Cable III, 300 V NEC: CMG • CEC: CMG FT4 UL AWM 20201 (600 V) UL PLTC Sunlight Res Oil Res

Conductor Color Coding: Data: Blue, White
Power: Red, Black

TC = Tinned Copper • PVC = Polyvinyl Chloride • FPE = Foam Polyethylene • TPE = Thermoplastic Elastomer • CPE = Chlorinated Polyethylene

DeviceBus® for Honeywell Smart Distributed System



- Impedance 120 Ohm

Part No.	Impedance (Ohm)	Pairs	OD (Nom)		Operating Temperature (°C)	Additional Features/Ratings
			Inch	mm		
16 AWG (19 x 29) and 20 AWG (19 x 32) Stranded TC Conductors • Foam Polyethylene (Data), PVC (Power) Insulation • TC Drain Wire • Individually Beldfoil® Shielded Pairs • Gray PVC Jacket						
3086A	120	2 1 pair data 1 pair power	.398	10.11	-40 to +80	Mini Cable, Trunk NEC: CL2 UL AWM 2464 (30 V, +60 °C) CSA AWM I/II A FT1
22 AWG (19 x 34) Stranded TC Conductors • Foam Polyethylene (Data), PVC (Power) Insulation • TC Drain Wire • Individually Beldfoil® Shielded Pairs • Gray PVC Jacket						
3087A	120	2 1 pair data 1 pair power	.290	7.37	-40 to +80	Micro Cable, Drop NEC: CL2 UL AWM 2464 (30 V, +60 °C) CSA AWM I/II A FT1

Conductor Color Code: Power Pairs: Black, White
Data Pairs: Blue, Brown

DeviceBus® for Square D/Seriplex® and Phoenix Contact INTERBUS®-S

Square D/Seriplex



Part No.	Pairs	OD (Nom)		Operating Temperature (°C)	Additional Features/Ratings
		Inch	mm		
18 AWG (16 x 30) and 22 (7 x 30) Stranded TC Conductors • Foam High-Density Polyethylene Insulation • TC Drain Wire • Overall Beldfoil® Shielding • Orange PVC Jacket					
3124A	2	.308	7.82	-20 to +75	Seriplex CBL 1822-P18 NEC: CL2 CM • CEC: CM UL AWM 20201 (600 V, +75 °C)
16 AWG (16 x 30) and 22 (7 x 30) Stranded TC Conductors • Foam High-Density Polyethylene Insulation • TC Drain Wire • Overall Beldfoil® Shielding • Orange PVC Jacket					
3125A	2	.368	10.11	-20 to +75	Seriplex CBL 1622-P1 NEC: CL2 CM • CEC: CM 300 V, +75 °C
12 AWG (65 x 30), 16 AWG (26 x 30) and 22 (7 x 30) Stranded TC Conductors • Foam High-Density Polyethylene (Data), PVC (Power) Insulation • TC Drain Wire • Overall Beldfoil® Shielding • Orange PVC Jacket					
3126A	3	.486 x .363	12.34 x 9.22	-20 to +75	Seriplex CBL 162212-P16 NEC: CL2 CM • CEC: CM 300 V, +75 °C

Conductor Color Coding: 16/18 AWG: Red, Black
 22 AWG: White, Green
 12 AWG: Black/White, Red/White

Phoenix Contact INTERBUS-S

- Impedance 100 Ohm



Part No.	Conductors	OD (Nom)		Operating Temperature (°C)	Additional Features/Ratings
		Inch	mm		
18 AWG (7 x 26) and 24 (7 x 33) Stranded TC Conductors • PE (Data), PVC (Power) Insulation • TC Drain Wire • Overall Beldfoil® + 90% TC Braid Shielding • Green Polyurethane Jacket					
3119A	3 Cond. power 3 pair data	.333	8.46	-40 to +80	UL AWM 20333 (300 V, +80 °C)
Stranded 24 AWG (7 x 32) TC Conductors • PE Insulation • Overall Beldfoil® + 90% TC Braid Shielding • Green Polyurethane Jacket					
3120A	3 pair	.277	7.04	-40 to +80	UL AWM 20333 (300 V, +80 °C)

TC = Tinned Copper • PE = Polyethylene • PVC = Polyvinyl Chloride

ControlNet™

RG6/U Type Quad Shielded Coaxial

- Impedance 75 Ohm



Part No.	Core Diameter		OD (Nom)		Operating Temperature (°C)	Additional Features/Ratings
	Inch	mm	Inch	mm		
18 AWG Solid BC-Covered Steel Conductor • Foam Polyethylene Insulation • Duobond® IV* Quad Shield • PVC Jacket (Black or Intrinsically Safe Blue)						
3092A**	.180	4.57	.298	7.57	-30 to +75	Impedance: 75 Ω NEC: CMR CL2R • CEC: CMG FT4
18 AWG Solid BC-Covered Steel Conductor • Foam FEP Insulation • Duobond IV* Quad Shield • Fluorocopolymer Jacket (Black or Intrinsically Safe Blue)						
3093A	.170	4.32	.274	6.96	-20 to +150	Plenum Rated Impedance: 75 Ω NEC: CMP • CEC: CMP FT6
20 AWG Stranded (105 x 40) BC Conductor • Foam Polyethylene Insulation • Duobond IV* Quad Shield • Black PVC Jacket						
3092F	.183	4.65	.303	7.70	-40 to +75	High Flex Impedance: 75 Ω NEC: CMR CL2R • CEC: CMG FT4
18 AWG Solid BC-Covered Steel Conductor • Foam Polyethylene Insulation • Duobond IV* Quad Shield • PVC Inner Jacket • Armor • Black PVC Sunlight-Resistant Outer Jacket						
123092A	.180	4.57	.620	15.75	-40 to +75	Aluminum Interlocked Armor Impedance: 75 Ω NEC: CM • CEC: CMG FT4, HL
18 AWG Solid BC-Covered Steel Conductor • Foam Polyethylene Insulation • Duobond IV* Quad Shield • PVC Inner Jacket • Armor • Black PVC Outer Jacket						
183092A	.180	4.57	.570	14.48	-30 to +75	Continuously Corrugated Aluminum Armor Impedance: 75 Ω NEC: CM CL2

* Duobond IV is a four-layer shield: (1) Duobond II Foil, (2) Aluminium Braid (60%), (3) Duofoil® Foil, (4) Aluminium Braid (40%).

** ABS and DNV-GL approved design also available. For more details please see Belden MarineTuff Offshore and Marine Cable Solutions brochure or consult Customer Service.

BC = Bare Copper • PVC = Polyvinyl Chloride • FEP = Fluorinated Ethylene Propylene

ControlBus™

Quad Shielded Coaxial

- Impedance 75 Ohm



Part No.	Core Diameter		OD (Nom)		Operating Temperature (°C)	Additional Features/Ratings
	Inch	mm	Inch	mm		
20 AWG Stranded (105 x 40) BC Conductor • Foam Polyethylene Insulation • Duobond® IV* Quad Shielding • Black PVC Jacket						
3092F**	.183	4.65	.303	7.70	-40 to +75	High Flex Impedance: 75 Ω RG-6/U Type NEC: CMR CL2R • CEC: CMG FT4 IEEE 802.4 MAP/IEEE 802.7 Mini-MAP
18 AWG Solid BC-Covered Steel Conductor • Gas-Injected Foam Polyethylene Insulation • Duobond IV* Quad Shielding • Gray PVC Jacket						
3131A	.189	4.57	.300	7.62	-30 to +75	Impedance: 75 Ω RG-6/U Type NEC: CMR CL2R • CEC: CMG FT4
18 AWG Solid BC-Covered Steel Conductor • Foam FEP Insulation • Duobond IV* Quad Shielding • Gray Fluorocopolymer Jacket						
3132A	.170	4.32	.274	6.96	-20 to +150	Plenum Impedance: 75 Ω Outdoor and Direct Burial RG-6/U Type NEC: CMP • CEC: CMP FT6 IEEE 802.4 MAP/IEEE 802.7 Mini-MAP
14 AWG Solid BC-Covered Steel Conductor • Gas-Injected Foam Polyethylene Insulation • Duobond IV* Quad Shielding • Gray PVC Jacket						
3094A	.280	7.11	.407	10.34	-30 to +80	Impedance: 75 Ω RG-11/U Type NEC: CMR CLR2 • CEC: CMG FT4 IEEE 802.4 MAP
14 AWG Solid BC-Covered Steel Conductor • Foam FEP Insulation • Duobond IV* Quad Shielding • Gray Fluorocopolymer Jacket						
3095A	.280	7.11	.387	9.83	-20 to +150	Plenum Impedance: 75 Ω Outdoor and Direct Burial RG-11/U Type NEC: CMP • CEC: CMG FT6 IEEE 802.4 MAP

* Duobond IV is a four-layer shield: (1) Duobond II Foil, (2) 60% Aluminium Braid, (3) Duofoil® Foil, (4) 40% Aluminium Braid.

** ABS and DNV-GL approved design also available. For more details please see Belden MarineTuff Offshore and Marine Cable Solutions brochure or consult Customer Service.

ControlBus™

Blue Hose® Industrial Twinax

- Impedance 78 Ohm



Part No.	Voltage	Nominal OD		Operating Temperature (°C)	Additional Features/Ratings
		Inch	mm		
20 AWG Stranded (7 x 28) TC Conductors • Polyethylene Insulation • Overall Beldfoil® + 55% TC Braid Shielding • Blue Sunlight-Resistant PVC Jacket					
9463	300 V	.238	6.05	-40 to +80	NEC: CM CL2 • CEC: CM UL AWM 2464 MSHA Approved*
20 AWG Stranded (42 x 36) TC Conductors • Polyethylene Insulation • Overall Beldfoil® + 85% TC Braid Shielding • Blue Sunlight-Resistant PVC Jacket					
9463F	300 V	.154	3.91	-40 to +80	High Flex NEC: CM CL2 • CEC: CM UL AWM 2464 MSHA Approved*
20 AWG Stranded (42 x 36) TC Conductors • Polyethylene Insulation • Overall Beldfoil® + 85% TC Braid Shielding • Blue Sunlight-Resistant FRNC Jacket					
9463NH	300 V	.25	6.35	-45 to +80	IEC 60332-3-24
20 AWG Stranded (42 x 36) TC Conductors • Polyethylene Insulation • Overall Beldfoil® + 85% TC Braid Shielding • Steel Wire Armor • Blue FRNC Outer and Inner Jacket					
9463LS	300 V	.42	10.75	-45 to +80	IEC 60332-3-24
20 AWG Stranded (7 x 28) TC Conductors • Polyethylene Insulation • Overall Beldfoil® + 55% TC Braid Shielding • PVC Inner Jacket • Aluminium, Steel Interlock or Corrugated Armor • Blue Sunlight-Resistant PVC Jacket					
129463	300 V	.563	14.30	-40 to +60	Aluminum Armored NEC: CM CL2 • CEC: CM, HLBCD
139463		.563	14.30	-40 to +60	Steel Armored NEC: CM CL2 • CEC: CM, HLBCD
189463		.500	12.70	-20 to +60	Corrugated Armored UL PLTC
20 AWG Stranded (7 x 28) TC Conductors • Low-Density Polyethylene Insulation • Overall Beldfoil® + 55% TC Braid Shielding • Blue Sunlight-Resistant LDPE Jacket					
9463DB	300 V	.154	3.91	-55 to +80	Continuously Flooded Direct Burial
20 AWG Stranded (7 x 28) TC Conductors • FEP Insulation • Overall Beldfoil® + 55% TC Braid Shielding • Blue Sunlight-Resistant FEP Jacket					
89463	300 V	.151	3.83	-70 to +200	Plenum NEC: CMP CL2P • CEC: CMP FT6

* MSHA = Mine Safety and Health Administration

Conductor Color Codes: Blue, Clear

TC = Tinned Copper • PVC = Polyvinyl Chloride • FEP = Fluorinated Ethylene Propylene • FRNC = Fire Retardant, Non-Corrosive • LDPE = Low-density Polyethylene

ControlBus™

Twinax Cables



Part No.	Impedance (Ohm)	Core Diameter		OD (Nom)		Operating Temperature (°C)	Additional Features/Ratings
		Inch	mm	Inch	mm		
20 AWG Stranded (7 x 28) TC Conductors • Polyethylene Insulation (Blue, Clear) • 93% TC Braid Shielding • Blue PVC Jacket							
9272	78	.156	3.96	.244	6.20	-20 to +60	Impedance: 78 Ω NEC: CM • CEC: CM UL AWM Style 2092 (300 V, +60 °C)
18 AWG Stranded (7 x 26) BC Conductors • Polyethylene Insulation (Clear, Clear) • Polyethylene Inner Jacket • 95% TC Double Braid Shielding • Black Non-contaminating PVC Outer Jacket							
9250	95	.285	7.24	.416	10.57	-40 to +80	Impedance: 95 Ω RG-22B/U Type VW-1 One Conductor Has Tinned Center Strand
20 AWG Stranded (7 x 28) One TC, One BC Conductor • Polyethylene Insulation (Natural, Natural) • Polyethylene Inner Jacket • Duofoil® + 86% TC Braid Shielding • Black PVC Outer Jacket							
9207	100	.236	5.99	.330	8.38	-30 to +75	Impedance: 100 Ω NEC: CMG CL2 • CEC: CMG FT4
20 AWG Stranded (7 x 28) One TC, One BC Conductor • Polyethylene Insulation (Natural, Natural) • Polyethylene Inner Jacket • Duofoil® + 86% TC Braid Shielding • Black FRNC Outer Jacket							
9207NH	100	0.236	5.99	.34	8.6	-45 to +80	IEC 60332-3-24
25 AWG Stranded (7 x 33) TC Conductors • Polyethylene Insulation (Blue, Clear) • Beldfoil® • Blue PVC Jacket							
9271	124	.170	4.32	.240	6.10	-20 to +60	Impedance: 124 Ω NEC: CM • CEC: CM UL AWM 2092 (300 V, +60 °C)
16 AWG Solid BC Conductors • Foam Polyethylene Insulation (Blue, Clear) • Duofoil + 90% TC Braid Shielding • Black PVC Jacket							
9860	124	.322	8.18	.440	11.18	-20 to +60	Impedance: 124 Ω NEC: CMX • CEC: CMX UL AWM 2448 (30 V, +60 °C) VW-1
22 AWG stranded (19 x 34) TC Conductors • Datalene® Insulation (Black, Yellow) • Duofoil Shielding • Black PVC Jacket • Stranded TC Drain Wire							
9182	150	.275	6.98	.345	8.76	-20 to +60	Impedance: 150 Ω NECL CL2X CMX • CEC: CMX UL AWM 2668 (30 V, +60 °C) VW-1
22 AWG Stranded (19 x 34) TC Conductors • Datalene® Insulation (Black, Yellow) • Duofoil Shielding • Black FRNC Jacket • Stranded TC Drain Wire							
9182NH	150	.275	6.98	.345	8.76	-45 to +80	IEC 60332-3-24
22 AWG Stranded (19 x 34) TC Conductors • Datalene Insulation (Black, Yellow) • Duofoil Shielding • Black FRNC Inner Jacket • Steel Wire Armor • Black FRNC Jacket • Stranded TC Drain Wire							
9182LS	150	.275	6.98	.56	14.25	-45 to +80	IEC 60332-3-24
22 AWG stranded (19 x 34) TC Conductors • Foam FEP Insulation (Black, Yellow) • Duofoil Shielding • Black FEP Jacket • Stranded TC Drain Wire							
89182	150	.278	7.06	.307	7.80	-70 to +200	Impedance: 150 Ω Plenum Rated NEC: CMP CL2P • CEC: CMP FT6

TC = Tinned Copper • BC = Bare Copper • PVC = Polyvinyl Chloride • FRNC = Fire Retardant, Non-Corrosive • FEP = Fluorinated Ethylene Propylene

MODBUS for RS-232 Applications

Shielded Twisted Pair Cables

- Impedance 50 Ohm



Part No.	Pairs	OD (Nom)		Operating Temperature (°C)	Additional Features/Ratings
		Inch	mm		

22 AWG • Polypropylene

Stranded (7 x 30) TC Conductors • Polypropylene Insulation • TC Drain Wire • Individually Beldfoil® Shielded Pairs • Chrome PVC Jacket					
8777	3	.273	6.93	-20 to +80	NEC: CM • CEC: CM UL AWM 2919 (30 V, +80 °C)
Stranded (7 x 30) TC Conductors • Polypropylene Insulation • TC Drain Wire • Individually Beldfoil® Shielded Pairs • Chrome FRNC Jacket					
8777NH	3	.273	6.93	-45 to +80	IEC 60332-3-24
Stranded (7 x 30) TC Conductors • Polypropylene Insulation • TC Drain Wire • Individually Beldfoil® Shielded Pairs • Steel Wire Armor • Black FRNC Jacket					
8777LS	3	.55	13.9	-45 to +80	IEC 60332-3-24

Conductor Color Coding: Red/Black, White/Black, Green/Black

Part No.	Pairs	Color Code	OD (Nom)		Insulation Thickness		Jacket Thickness		Capacitance				Additional Features/Ratings
			Inch	mm	Inch	mm	Inch	mm	Cond. - Cond.		Cond. - Shield		
									pF/Ft	pF/m	pF/Ft	pF/m	

22 AWG • FEP/Flamarrest®

Stranded (7 x 30) TC Conductors • FEP Insulation • Individually Beldfoil® Shielded Pairs • 22 AWG TC Drain Wire • Natural Flamarrest Jacket													
82777	3	Chart 3	.237	6.02	.011	.28	.017	.43	35	115	76	249	Plenum NEC: CMP • CEC: CMP FT6 46 Ω Nom. Impedance 62% Velocity of Prop. Conductor DCR (Nom): 14.7 Ω/1000' (48.2 Ω/km)

MODBUS II for RG-6 Type Coaxial Cables

Coaxial Cables

- Impedance 75 Ohm



Part No.	Core Diameter		OD (Nom)		Operating Temperature (°C)	Additional Features/Ratings
	Inch	mm	Inch	mm		

18 AWG Solid BC-Covered Steel Conductor • Foam Polyethylene Insulation • Duobond® IV* Quad Shield • PVC Jacket (Black or Intrinsically Safe Blue)						
3092A	.180	4.57	.298	7.57	-30 to +75	Impedance: 75 Ω NEC: CMR CL2R • CEC: CMG FT4
18 AWG Solid BC-Covered Steel Conductor • Foam FEP Insulation • Duobond IV* Quad Shield • Fluorocopolymer Jacket (Black or Intrinsically Safe Blue)						
3093A	.170	4.32	.274	6.96	-20 to +150	Plenum Rated Impedance: 75 Ω NEC: CMP • CEC: CMP FT6
20 AWG Stranded (105 x 40) BC Conductor • Duobond IV* Quad Shield • Foam Polyethylene Insulation • Black PVC Jacket						
3092F	.183	4.65	.303	7.70	-40 to +75	High Flex Impedance: 75 Ω NEC: CMR CL2R • CEC: CMG FT4

* Duobond IV is a four-layer shield: (1) Duobond II Foil, (2) TC Braid (94%), (3) Duofoil® Foil, (4) TC Braid (90%).

TC = Tinned Copper • BC = Bare Copper • PVC = Polyvinyl Chloride • FRNC = Fire Retardant, Non-Corrosive • FEP = Fluorinated Ethylene Propylene | Belden Color Code Charts can be found at page 344.

LonWorks

Paired Cable 300 V, +80 °C



- Impedance 100 Ohm
- Level IV Cables

Part No.	Pairs	Color Code	OD (Nom)		Insulation Thickness		Jacket Thickness		Additional Features
			Inch	mm	Inch	mm	Inch	mm	

22 AWG BC Conductors • Foamed Polyethylene Insulation • White LSNH Jacket

Unshielded

7701NH	1	White/Blue, Blue/White	.138	3.5	.009	.23	.018	.45	Flame Resistance IEC 60332-3C or -24
7702NH	2	Orange/White, White/Orange	.205	5.2	.009	.23	.020	.50	

Overall Beldfoil® Shield

7703NH	1	White/Blue, Blue/White	.181	4.6	.015	.4	.018	.45	Flame Resistance IEC 60332-3C or -24
7704NH	2	Orange/White, White/Orange	.256	6.5	.011	.3	.020	.50	

Backbone Cable • Plenum • 300 V, +80 °C • Unshielded



Part No.	Pairs	Color Code	OD (Nom)		Insulation Thickness		Jacket Thickness		Additional Features/Ratings
			Inch	mm	Inch	mm	Inch	mm	

16 AWG • 19 x 29 • PVC/PVC

Stranded TC Conductors • PVC Insulation • Chrome PVC jacket

8471	1	Black/White	.274	6.96	.023	.58	.032	.81	NEC: CMG • CEC: CMG FT4 UL AWM Style 2598
------	---	-------------	------	------	------	-----	------	-----	--

16 AWG • 19 x 29 • Armored

Stranded BC Conductors • Polyethylene Insulation • Unshielded • LSNH Inner Jacket • Steel Wire Armor • Chrome LSNH Outer Jacket

8471LS	1	Black/White	.413	10.5	.022	.58	.035/.051	.89/1.3	IEC 60332-3-24
--------	---	-------------	------	------	------	-----	-----------	---------	----------------

16 AWG • 19 x 29

Stranded BC Conductors • Polyethylene Insulation • Unshielded • Chrome LSNH Outer Jacket

8471NH	1	Black/White	.28	7.1	.023	.58	.035	.89	IEC 60332-3-24
--------	---	-------------	-----	-----	------	-----	------	-----	----------------

High-Temperature Backbone Cable 300 V, +150 °C • Unshielded

- VW-1



Part No.	Conductors	Color Code	OD (Nom)		Insulation Thickness		Jacket Thickness	
			Inch	mm	Inch	mm	Inch	mm

16 AWG • 19 x 29 • ETFE/ETFE

Stranded (19 x 29) TC Conductors • Cabled • ETFE Insulation • Clear ETFE Jacket

85102	2	Chart 2R	.211	5.36	.014	.36	.019	.48
-------	---	----------	------	------	------	-----	------	-----

BC = Bare Copper • TC = Tinned Copper • PVC = Polyvinyl Chloride • LSNH = Low Smoke No Halogen • ETFE = Ethylene/Tetrafluoroethylene | Belden Color Code Charts can be found at page 344.

DataTray® 600 V Twinaxial

DataTray® 600 V Twinax



Part No.	Impedance (Ohm)	Core Diameter		OD (Nom)		Operating Temperature (°C)	Additional Features/Ratings
		Inch	mm	Inch	mm		
18 AWG Stranded (7 x 26) TC Conductors • Flame-retardant Polyolefin Insulation (Natural, Blue) • Overall Beldfoil® + 55%TC Braid Shield • Blue Sunlight-resistant PVC Jacket • TC Drain Wire							
3072F*	78	.192	4.88	.324	8.23	-40 to +75	Impedance: 78 Ω NEC: CMG, ITC, TC, PLTC • CEC: CMG FT4 UL TC MSHA Approved**
3073F	100	.246	6.25	.388	9.86	-40 to +75	Impedance: 100 Ω NEC: CMG, ITC, TC, PLTC • CEC: CMG FT4 UL TC
3074F	124	.328	8.33	.460	11.86	-40 to +75	Impedance: 124 Ω NEC: CMG, ITC, TC, PLTC • CEC: CMG FT4 UL TC

* ABS and DNV-GL approved design also available. For more details please see Belden MarineTuff Offshore and Marine Cable Solutions brochure or consult Customer Service.

** MSHA = Mine Safety and Health Administration

TC = Tinned Copper • PVC = Polyvinyl Chloride

CC Link



- Impedance 100 Ohm

Part No.	Category	Pairs	Conductor (Stranding)		Nominal OD (mm)	Jacket	Shielding	Operating Temperature (°C)	Additional Features/Ratings
			Solid	Stranded					
Category 6 • 4 Pair • Shielded • LSNH Outer Jacket • Bonded-Pair									
7953A	Cat 6	4	AWG 23 (1)	–	8.64	LSNH	Overall Beldfoil® Shielding	-40 to +75	600 V UL AWM Shielded EtherNet/IP Compliant NEC: CMR, CMX-Outdoor • CEC: CMR FT4 Sunlight and Oil Resistant
Category 5e • 4 Pair • Unshielded and Shielded • PVC Outer Jacket • Bonded-Pair									
7929A		4	AWG 24 (1)	–	6.73		Overall Beldfoil® Shielding		NEC: CMR, CMX-Outdoor • CEC: CMR FT4 MSHA Approved* Sunlight and Oil Resistant
7921A	Cat 5e	4	AWG 24 (1)	–	8.38	PVC	Foil Braid >70%	-40 to +75	Heavy Shielded EtherNet/IP Compliant NEC: CMR, CMX-Outdoor • CEC: CMR FT4 Sunlight and Oil Resistant
7939A		4	–	AWG 24 (7)	8.60		Overall Beldfoil® Shielding		NEC: CMR, CMX-Outdoor • CEC: CMR FT4 Sunlight and Oil Resistant

* MSHA = Mine Safety and Health Administration



- Impedance 110 Ohm

Part No.	Pairs	Conductor (Stranding)		Nominal OD (mm)	Jacket	Shielding	Operating Temperature (°C)	Additional Features/Ratings
		Solid	Stranded					
20 AWG (7 x 28) Stranded BC Conductors • Foam High-Density Polyethylene Insulation • TC Drain Wire • Overall Beldfoil® + 78% TC Braid Shielding • Red PVC Jacket								
1348A	3 Cond.	–	AWG 20 (7)	7.70	PVC	Foil Braid >78%	-30 to +60	3 Conductor, 300 V NEC: CM • CEC: CM
3 x 20 AWG (7 x 28) and 2 x 18 AWG (7 x 26) Stranded BC Conductors • Foam High-Density Polyethylene (Data), PVC (Power) Insulation • 3 Data cables: Overall Beldfoil® + 78% TC Braid Shielding, TC Drain Wire • Black PVC Inner Jacket • Red PVC Outer Jacket								
1349A	3 Cond. Data 2 Cond. Power	–	3 x 20 AWG (7) and 2 x 18 AWG (7)	13.00	PVC	Foil Braid >78%	-30 to +60	5 Conductor, 300 V NEC: CM • CEC: CM

Conductor Color Coding: Blue, Yellow, White (Data); Black, White (Power)

BC = Bare Copper • TC = Tinned Copper • PVC = Polyvinyl Chloride • LSNH = Low Smoke No Halogen

KNX/EIB Approved Cables



Part No.	Applicable Standard(s)	No. of Pairs	Color Code	Standard Lengths		Standard Unit Weight		Insulation Thickness		Outer Jacket Thickness		Nominal OD	
				ft.	mm	lbs.	mm	Inch	mm	Inch	mm	Inch	mm

0.8 mm (0.5 mm² or AWG 20)

Solid BC • PVC Insulation • 100% Foil Screen • Green PVC Jacket KNX Reg. no. 109/7253/05													
YE00819	EN 50090 CEN/TC 247	1	Red/Black	328	100	8.4	3.8	.012	.30	.043	1.10	.217	5.50
				500	500	46.3	21.0						
				3280	1000	89.3	40.5						
YE00820	EN 50090 CEN/TC 247	2	Red/Black White/Yellow	328	100	11.5	5.2	.012	.30	.043	1.10	.241	6.10
				500	500	61.7	28.0						
				3280	1000	122.3	55.5						
Solid BC • PE Insulation • 100% Foil Screen • Green LSNH Jacket KNX Reg. no. 109/7254/05													
YE00905	IEC 60189-2 IEC 60332-1	1	Red/Black	328	100	8.6	3.9	.016	.40	.043	1.10	.220	5.60
				1624	500	47.4	21.5						
				3280	1000	91.5	41.5						
YE00906	IEC 60189-2 IEC 60332-1	2	Red/Black White/Yellow	328	100	12.3	5.6	.016	.40	.043	1.10	.282	6.30
				1624	500	68.3	31.0						
				3280	1000	131.1	59.5						

BC = Bare Copper • PVC = Polyvinyl Chloride • PE = Polyethylene • LSNH = Low Smoke No Halogen

Coaxial Ethernet

Thinnet 10Base2 Ethernet

- Impedance 50 Ohm



Part No.	AWG	Core Diameter		OD (Nom)		Operating Temperature (°C)	Additional Features/Ratings
		Inch	mm	Inch	mm		
Stranded (19 x 32) TC Conductor • Foam Polyethylene Insulation • Duobond® II Foil + 93% TC Braid Shielding • Gray PVC Jacket							
9907	20	.102	2.59	.185	4.70	-40 to +80	Impedance: 50 Ω RG-58 Type NEC: CM CL2 • CEC: CM UL AWM Style 1354 (30 V, +60 °C)
Stranded (19 x 32) TC Conductor • Foam FEP Insulation • Duobond II Foil + 93% TC Braid Shielding • Gray Fluorocopolymer Jacket							
89907	20	.095	2.41	.160	4.06	-20 to +150	RG-58A/U Type Plenum Rated Impedance: 50 Ω NEC: CMP CL2P • CEC: CMP FT6 Outdoor and Direct Burial

Thicknet 10Base5 Ethernet

- Impedance 50 Ohm



Part No.	AWG	Core Diameter		OD (Nom)		Operating Temperature (°C)	Additional Features/Ratings
		Inch	mm	Inch	mm		
Solid BC Conductor • Foam Polyethylene Insulation • Duobond IV* Quad Shielding • Yellow PVC Jacket							
9880	12	.243	6.17	.405	10.29	-40 to +60	Impedance: 50 Ω NEC: CM CL2 • CEC: CM UL AWM Style 1478 (30 V, +60 °C)
Solid BC Conductor • Foam FEP Insulation • Duobond IV* Quad Shielding • Orange Fluorocopolymer Jacket							
89880	12	.245	6.22	.375	9.53	-25 to +150	Plenum Rated Impedance: 50 Ω NEC: CMP CL2P • CEC: CMP FT6 Outdoor and Direct Burial

* Duobond IV is a four-layer shield: (1) Duobond II Foil, (2) TC Braid (94%), (3) Duofoil® Foil, (4) TC Braid (90%).

MachFlex Flexible Control Cables

300 V MachFlex Data Cables (1 Million Flex Cycles)

Paired Cable • Shielded



- 24 AWG (41 x 40) BC Conductors
- Foam Polyethylene Insulation with Skin
- Overall Beldfoil® + 85% TC Braid Shield
- Green PVC Jacket
- 24 AWG (41 x 40) TC Drain Wire
- NEC: CM
- CEC: CM
- -20 °C to +60 °C
- -5 °C to +60 °C Flexing

Part No.	Pairs	OD (Nom)		Capacitance (Max)*		Additional Features/Ratings
		Inch	mm	pF/Ft	pF/m	

24 AWG (41 x 40) BC Conductors • Foam Polyethylene Insulation with Skin • Overall Beldfoil® + 85% TC Braid Shield • 24 AWG (41 x 40) TC Drain Wire • Green PVC Jacket

120 Ohm Impedance • RS-232 and RS-485

Part No.	Pairs	Core OD (Nom) Inch	Core OD (Nom) mm	Cable OD (Nom) Inch	Cable OD (Nom) mm	Capacitance (Max) pF/Ft	Capacitance (Max) pF/m	Additional Features/Ratings
7200A	1	.240	6.10					
7201A	2	.322	8.18	15.0		49.2		
7202A	3	.347	8.81					
7203A	4	.362	9.20					

100 Ohm Impedance • RS-232 and RS-422

7205A	1	.232	5.89	14.0		45.9		Oil Res II
-------	---	------	------	------	--	------	--	------------

150 Ohm Impedance • RS-232 and RS-485

7206A	1	.302	7.67	10.0		32.8		
-------	---	------	------	------	--	------	--	--

* One conductor to other conductors connected to shield.
Conductor Color Coding: One-Pair Cable: White, Blue

Multi-Pair Configurations: 1 White/Blue Stripe – Blue/White Stripe
 2 White/Orange Stripe – Orange/White Stripe
 3 White/Green Stripe – Green/White Stripe
 4 White/Brown Stripe – Brown/White Stripe

MachFlex Vision 75 Ohm Coax Cables (1 Million Flex Cycles)

75 Ohm Coax



- UL AWM 1354 (30 V, +80 °C)
- CSA AWM I/II A/B FT1
- -40 °C to +80 °C

Part No.	Core OD (Nom)		Cable OD (Nom)		Additional Features/Ratings
	Inch	mm	Inch	mm	

Foam Polyethylene Insulation • 95% TC "French Braid" Shield • Matte Blue Belflex Jacket

30 AWG Stranded • 7 x 38 • Tinned Copper Alloy Conductor

7500A	.056	1.42	.110	2.79	Sub-Mini Type
-------	------	------	------	------	---------------

25 AWG Stranded • 19 x 38 • BC Conductor

7501A	.090	2.29	.146	3.71	Mini Type
-------	------	------	------	------	-----------

22 AWG Stranded • 19 x 34 • BC Conductor

7502A	.146	3.71	.242	6.15	RG-59 Type
-------	------	------	------	------	------------

20 AWG Stranded • 7 x 15 x 40 • BC Conductor

7503A	.185	4.70	.275	6.99	RG-6/U Type
-------	------	------	------	------	-------------

16 AWG Stranded • 7 x 37 x 40 • BC Conductor

7504A	.285	7.24	.405	10.29	RG-11 Type
-------	------	------	------	-------	------------

BC = Bare Copper • TC = Tinned Copper • PVC = Polyvinyl Chloride



Products specifically designed to meet the full requirements of your mission critical applications.

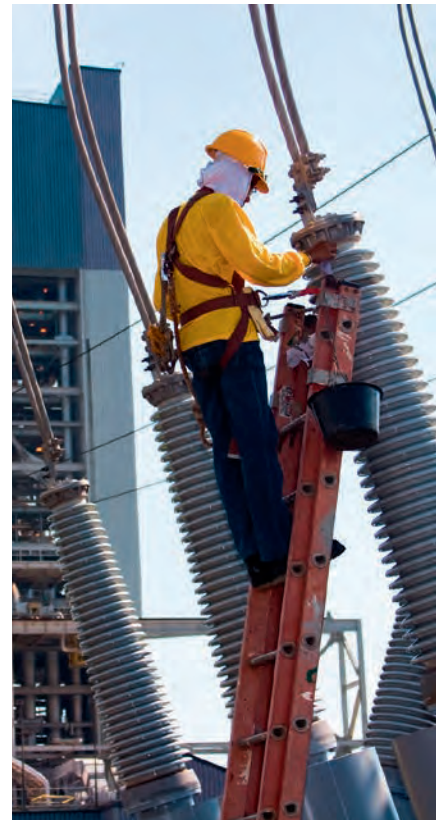

Industrial Data and Process Automation DataTuff® Industrial Ethernet Cables

Section Table of Contents

Industrial Data and Process Automation	
DataTuff® Industrial Ethernet Cables	
Overview	252
Introduction and Cable Selection Guide	253–256
DataTuff® Industrial Ethernet	
Permanent Installation Cables	257–261
Moderate Flexing Cables	262–264
Continuous Flexing Cables	265
DataTuff® PROFINET	
Permanent Installation Cables	266
Moderate Flexing Cables	267
Continuous Flexing Cables	268

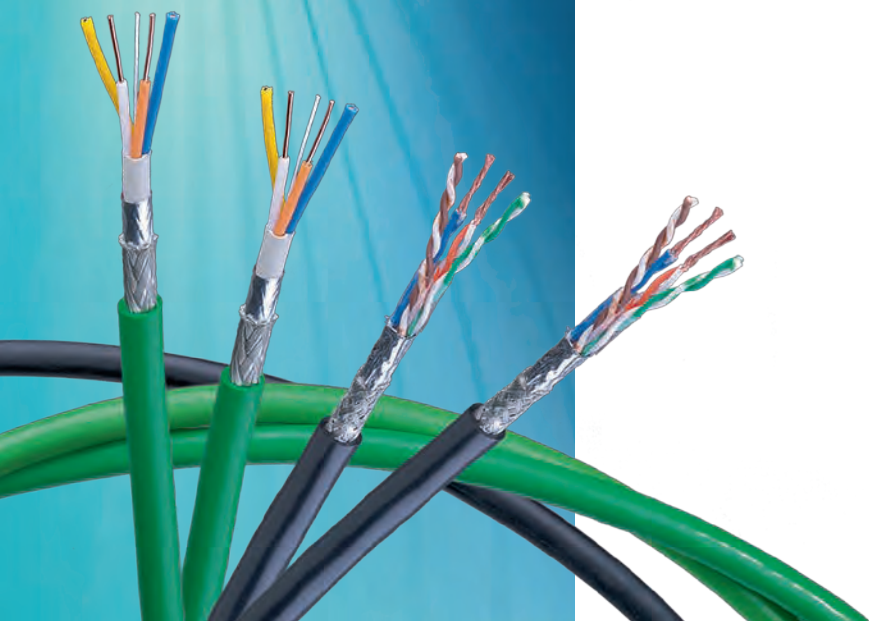

DataTuff® Industrial Ethernet Cables



The comprehensive DataTuff® Industrial Ethernet cable range ensures the highest level of reliability, quality and performance. Specifiers can choose from products suitable for indoor and outdoor applications, for use underground, and for other harsh conditions.

Product Features

- Industrial Ethernet and PROFINET designs
- PVC, polyethylene, FEP, FRNC/LSNH, PUR, or TPE jackets
- Twisted Pair or Bonded-Pair™ technology
- Shielded and unshielded designs
- Torsion resistant guaranteed for more than 2 million cycles
- Cables designed for trailing/drag chain applications tested for more than 2 million or up to 10 million bending cycles
- Oil, abrasion and sunlight resistant designs
- Direct burial and CMX/outdoor rated cables
- Operation temperature from -70 °C up to +150 °C, designs suitable for hi/lo temperature installations

Benefits

Broadest Portfolio on the Market

- Belden DataTuff® is EMEA's most comprehensive portfolio of Industrial Ethernet cable and connectivity products.

Reliability

- Robust design: industrial grade jackets withstand exposure to oil, chemicals, rough handling, abrasion, UV and temperature variations, etc
- Product consistency: manufactured in ISO certified manufacturing facilities, Belden's state-of-the-art processes ensure quality in each product. Product consistency for ease of termination and assembly is a mainstay of our products.

Future Proof

- Belden supports the migration of Ethernet networks to 10 Gb/s

Applications

DataTuff® range is primarily built and designed for harsh/mission-critical applications. The products are used in automation, machine building, food/beverage, petro-chemical, and many more industrial markets.



DataTuff® Industrial Ethernet Cables

Introduction

Breadth of Line: Category 5e, Category 6 and Category 7 Cables

- Twisted Pair or Bonded-Pair™ technology
- Unshielded or shielded cables
- Solid or stranded conductors
- Plenum or non-plenum
- Polyolefin or FEP insulation
- PVC, polyethylene, FEP, FRNC/LSNH, PUR, or TPE jackets
- Heavy duty, double jacketed, or aluminum armored
- Halogen-free or Low Smoke Zero Halogen constructions
- Versions suitable for burial or outdoor use, gasoline resistance, high and low temperatures Jackets sequentially marked at regular intervals (typically 2 ft)
- Performance third-party verified to ANSI/TIA-568-B.2

Field-Proven Performance for Such Conditions as:

- Oil, sunlight and gasoline
- Temperature variations
- Abrasion and crushing
- Flexing
- EMI/RFI presence
- Weldsplatter resistance

Approvals

- All RoHS approved
- Many are EtherNet/IP compliant
- Some MSHA approved for mining environments

Belden's Patented Bonded-Pair Technology

Most DataTuff cables feature Belden's Bonded-Pair technology, a patented cable construction which affixes the conductor insulation of the cable pairs along their longitudinal axes to ensure that no performance-robbing gaps can develop between the conductor pairs.

- No gaps between the conductor pairs ensures that the conductor-to-conductor spacing, or centricity, is always uniform
- With uniform centricity, the cable offers excellent and consistently reliable electrical performance
- Installable Performance® is achieved – the affixing of the insulation of the cable pairs and the uniform centricity translate to superior electrical performance, even after the cable has been subjected to the bending, pulling and twisting inherent in the installation process

Tests Prove the Post-Installation Effectiveness of Belden Bonded-Pair Cables

Belden performed tests that simulate the effects of the installation process, both on an industry-leading 350 MHz Cat 5e cable (a nonbonded-pair cable) and a Belden 350 MHz Cat 5e bonded-pair cable. For comparison, the cables were tested both right off the reel and after an installation stress test. Results showed that the nonbonded-pair cable had an RL degradation greater than 12 dB – over 15 times worse than its before-installation value. The Bonded-Pair cables showed greater integrity in maintaining RL performance.

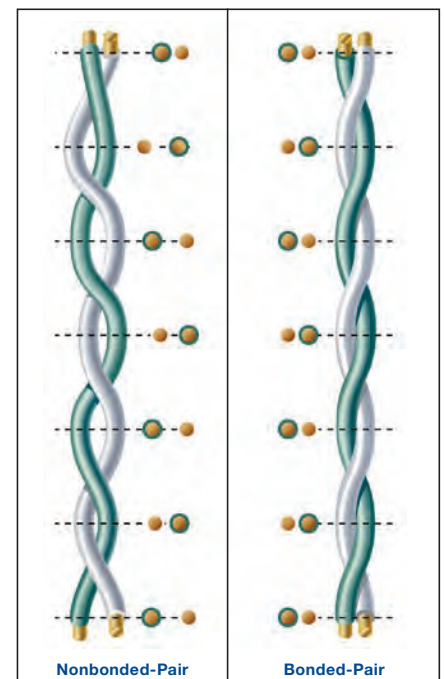

DataTuff® Industrial Ethernet Cable Selection Guide

This table is meant to help you select the proper cable.

Part No.	Conductor		Installation		Environmental										Industrial Grade Jacket		
	Solid	Stranded	Installation Stress Resistance*	Pull Tension	Oil Res.	UV Sun Res.	Weld-splatter Res.	CMX-Outdoor	Direct Burial	Gas Res.	LSZH	MSHA	Hi/Low Temp.	600 V AWM	Heavy	Upjacket	Armored
Industrial Ethernet																	
Category 7 Shielded Cable																	
74004E	•		45		•	•											
74004NH	•		45		•	•					•						
74005E		•	30		•	•											
74005NH		•	30		•	•					•						
74005PU		•	30		•	•					•						
Category 6 Shielded Cable																	
7953A EtherNet/IP	•		40		•	•		•					•			•	
Category 6 Unshielded Cable																	
7940A EtherNet/IP	•		40		•	•		•								•	
7927A	•		45		•	•										•	
11872A	•		45														•
121872A	•		200			•											•
7931A	•		40		•	•				•		•				•	
Category 5e Shielded Cable																	
7929A	•		40		•	•		•				•				•	
7958A EtherNet/IP	•		35		•	•							•			•	
7919A	•		25		•	•		•				•				•	
7939A		•	40		•	•										•	
7921A EtherNet/IP	•		75		•	•		•								•	
7957A EtherNet/IP	•		75		•	•		•					•			•	
7937A	•		40		•	•			•								•
7936A	•		40			•					•	•				•	
74001E	•		40		•	•											
74001NH	•		40		•	•					•						
74001PU	•		40		•	•											
74002E		•	30		•	•											
74002NH		•	30		•	•					•						
74002PU		•	30		•	•					•						
7938A High Flex		•	40		•	•	•										•
74003PU High Flex Trailing		•	30		•	•					•						
74009PU High Flex Torsion		•	30		•	•	•				•						

* Products with Bonded-Pair™ technology provide Installable Performance® advantages; refer to Belden's Bonded-Pair Cable Bulletin BP02.

Part No.	Conductor		Installation		Environmental										Industrial Grade Jacket		
	Solid	Stranded	Installation Stress Resistance*	Pull Tension	Oil Res.	UV Sun Res.	Weld-splatter Res.	CMX-Outdoor	Direct Burial	Gas Res.	LSZH	MSHA	Hi/Low Temp.	600 V AWM	Heavy	Upjacket	Armored

Industrial Ethernet

Category 5e Unshielded Cable																	
7923A <i>EtherNet/IP</i>	•		•	40	•	•		•				•				•	
7922A PLTC	•		•	40	•	•		•								•	
7918A	•			35	•	•		•				•				•	
11700A <i>EtherNet/IP</i>	•		•	40	•	•		•				•				•	
11700A2 Oil Res. 1/II	•		•	40	•	•										•	
121700A	•		•	40	•	•											•
121700R	•		•	40	•	•											•
7924A		•	•	40	•	•		•								•	
7930A		•		25	•	•		•								•	
7934A <i>EtherNet/IP</i>	•		•	40	•	•			•							•	
7935A <i>EtherNet/IP</i>	•		•	40		•						•				•	
7928A <i>EtherNet/IP</i>	•		•	40	•	•		•		•			•			•	
2-Pair Category 5e Shielded Cable																	
7933A <i>EtherNet/IP</i>	•		•	20	•	•										•	
72001E	•			30	•	•											
72001NH	•			30	•	•						•					
72002E		•		20	•	•											
72002NH		•		20	•	•						•					
72002PU		•		20	•							•					
2-Pair Category 5e Unshielded Cable																	
7932A <i>EtherNet/IP</i>	•		•	20	•	•										•	

* Products with Bonded-Pair™ technology provide Installable Performance® advantages; refer to Belden's Bonded-Pair Cable Bulletin BP02.

DataTuff® Industrial Ethernet Cable Selection Guide (continued)

Part No.	Conductor		Installation		Environmental										Industrial Grade Jacket		
	Solid	Stranded	Installation Stress Resistance*	Pull Tension	Oil Res.	UV Sun Res.	Weld-splatter Res.	CMX-Outdoor	Direct Burial	Gas Res.	LSZH	MSHA	Hi/Low Temp.	600 V AWM	Heavy	Upjacket	Armored

PROFINET

Category 5e Shielded Cable																	
70006E	•		40	•													
70006NH	•		40	•	•						•						
7960A	•		40	•	•			•								•	
70007E		•	40	•													
7961A		•	40	•	•			•								•	
70007NH		•	40	•	•						•						
70007PU		•	40	•	•												
70008PU High Flex Trailing		•	40	•	•												
7962A High Flex Trailing		•	40	•	•	•	•	•								•	
70009PU High Flex Torsion		•	40	•	•	•											

* Products with Bonded-Pair™ technology provide Installable Performance® advantages; refer to Belden's Bonded-Pair Cable Bulletin BP02.

DataTuff® Industrial Ethernet
Permanent Installation Cables

Category 5e • 2 Pair • Unshielded and Shielded



Part No.	Data Rates	Category	Conductor (Stranding)		Nominal OD (mm)	Jacket	Shielding		Design		Operating Temperature (°C)	Additional Features/Ratings
			Solid	Stranded			Shielded	Unshielded	Twisted Pair	Bonded-Pair		
Category 5e • 2 Pair • Unshielded and Shielded • PVC Outer Jacket												
72001E					6.00		Overall Foil + 80% Braid	-	✓	-	-40 to +80	Heavy Shielded 300 V UL AWM 2464 Sunlight and Oil Resistant Flame Retardant
7933A	100 Mb/s	Cat 5e	AWG 24 (1)	-	5.77	PVC	Overall Foil	-	-	✓	-40 to +75	EtherNet/IP Compliant NEC: CMR • CEC: CMR FT4 Sunlight and Oil Resistant
7932A					5.26		-	✓	-	✓	-40 to +75	EtherNet/IP Compliant NEC: CMR • CEC: CMR FT4 Sunlight and Oil Resistant
Category 5e • 2 Pair • Shielded • LSZH Outer Jacket												
72001NH	100 Mb/s	Cat 5e	AWG 24 (1)	-	7.00	LSZH	Overall Foil + 80% Braid	-	✓	-	-40 to +80	Heavy Shielded 300 V UL AWM 21286 Sunlight and Oil Resistant Flame Retardant

Compatible with Belden Metal Body RJ45 Plugs R301601 and R301602

Conductor Color Codes: Pair 1: White/Blue Stripe & Blue
Pair 2: White/Orange Stripe & Orange

PVC = Polyvinyl Chloride • LSZH = Low Smoke Zero Halogen

DataTuff® Industrial Ethernet
Permanent Installation Cables

Category 5e • 4 Pair • Unshielded and Shielded



121700R

Part No.	Data Rates	Category	Conductor (Stranding)		Nominal OD (mm)	Jacket	Shielding		Design		Operating Temperature (°C)	Additional Features/Ratings
			Solid	Stranded			Shielded	Unshielded	Twisted Pair	Bonded-Pair		
Category 5e • 4 Pair • Unshielded and Shielded • PVC Outer Jacket												
74001E					7.00		Overall Foil + 80% Braid	-	✓	-	-40 to +80	Heavy Shielded 300 V UL AWM 2464 Sunlight and Oil Resistant Flame Retardant
7921A					8.38		Overall Foil + 70% Braid	-	-	✓		Heavy Shielded EtherNet/IP Compliant NEC: CMR, CMX-Outdoor CEC: CMR FT4 Sunlight and Oil Resistant
7957A					8.38		Overall Foil + 70% Braid	-	-	✓		Heavy Shielded 60 V UL AWM EtherNet/IP Compliant NEC: CMR, CMX-Outdoor CEC: CMR FT4 Sunlight and Oil Resistant
7923A					5.84		-	✓	-	✓		EtherNet/IP Compliant MSHA Approved* NEC: CMR, CMX-Outdoor CEC: CMR FT4 Sunlight and Oil Resistant
7918A					5.84		-	✓	✓	-		MSHA Approved* NEC: CMR, CMX-Outdoor CEC: CMR FT4
7929A					6.73		Overall Foil	-	-	✓		NEC: CMR, CMX-Outdoor CEC: CMR FT4 MSHA Approved* Sunlight and Oil Resistant
7958A	1 Gb/s	Cat 5e	AWG 24 (1)		6.73	PVC	Overall Foil	-	-	✓	-40 to +75	600 V UL AWM EtherNet/IP Compliant NEC: CMR, CMX-Outdoor CEC: CMR FT4 Sunlight and Oil Resistant
7919A					6.73		Overall Foil	-	✓	-		NEC: CMR, CMX-Outdoor CEC: CMR FT4 MSHA Approved* Sunlight and Oil Resistant CMX-Outdoor
11700A					7.24		-	✓	-	✓		Upjacketed - PVC Inner Jacket EtherNet/IP Compliant MSHA Approved* NEC: CMR, CMX-Outdoor CEC: CMR FT4 Sunlight and Oil Resistant
11700A2					7.24		-	✓	-	✓		Upjacketed – PVC Inner Jacket Outstanding Oil Res I/II NEC: CMR • CEC: CMR FT4 Sunlight and Oil Resistant
121700A					13.46		-	✓	-	✓		Interlocked Aluminium Armor Upjacketed – PVC Inner Jacket NEC: CM • CEC: HL, CMG FT4 Sunlight and Oil Resistant
121700R					13.46		-	✓	-	✓		Interlocked Aluminium Armor Upjacketed – PVC Inner Jacket -40 °C Cold Impact NEC: CM • CEC: HL, CMG FT4 Sunlight and Oil Resistant
7922A			AWG 22 (1)		7.65		-	✓	-	✓		UL PLTC NEC: CMR, CMX-Outdoor CEC: CMR FT4 Sunlight and Oil Resistant

* Pennsylvania Department of Environmental Resources and United States Mine Safety and Health Administration Certification
Compatible with Belden Metal Body RJ45 Plugs R301601 and R301602

Conductor Color Codes: Pair 1: White/Blue Stripe & Blue • Pair 2: White/Orange Stripe & Orange • Pair 3: White/Green Stripe & Green • Pair 4: White/Brown Stripe & Brown

PVC = Polyvinyl Chloride

DataTuff® Industrial Ethernet
Permanent Installation Cables

Category 5e • 4 Pair • Unshielded and Shielded (continued)



Part No.	Data Rates	Category	Conductor (Stranding)		Nominal OD (mm)	Jacket	Shielding		Design		Operating Temperature (°C)	Additional Features/Ratings
			Solid	Stranded			Shielded	Unshielded	Twisted Pair	Bonded-Pair		
Category 5e • 4 Pair • Unshielded and Shielded • LSZH Outer Jacket												
74001NH					7.00		Overall Foil + 80% Braid	-	-	-	-40 to +80	Heavy Shielded 300 V UL AWM 21286 Sunlight and Oil Resistant Flame Retardant
7935A	1 Gb/s	Cat 5e	AWG 24 (1)	-	5.84	LSZH	-	✓	-	✓	-40 to +75	EtherNet/IP Compliant NEC: CM • CEC: CM FT1 Sunlight Resistant
7936A					6.73		Overall Foil	-	-	✓		NEC: CM • CEC: CMG FT4 Sunlight Resistant
Category 5e • 4 Pair • Unshielded • PE Outer Jacket												
7934A					5.84		-	✓	-	✓		Waterblocked Burial Halogen Free EtherNet/IP Compliant Sunlight and Oil Resistant
7937A	1 Gb/s	Cat 5e	AWG 24 (1)	-	7.01	PE	Overall Foil	-	-	✓	-40 to +75	Waterblocked Burial Upjacketed – PE Inner Jacket Halogen Free Sunlight and Oil Resistant
Category 5e • 4 Pair • Unshielded • FEP Outer Jacket												
7928A	1 Gb/s	Cat 5e	AWG 24 (1)	-	4.75	FEP	-	✓	-	✓	-75 to +150	High and Low Temp EtherNet/IP Compliant NEC: CMP • CEC: CMP FT6 Outstanding Oil Res I/II Gas Resistant Sunlight Resistant
Category 5e • 4 Pair • Shielded • PUR Outer Jacket												
74001PU	1 Gb/s	Cat 5e	AWG 24 (1)	-	6.60	PUR	Overall Foil + 80% Braid	-	✓	-	-40 to +80	Heavy Shielded 300 V UL AWM 20549 Sunlight and Oil Resistant Flame Retardant FT2 Halogen Free

Compatible with Belden Metal Body RJ45 Plugs R301601 and R301602

Conductor Color Codes: Pair 1: White/Blue Stripe & Blue
Pair 2: White/Orange Stripe & Orange
Pair 3: White/Green Stripe & Green
Pair 4: White/Brown Stripe & Brown

LSZH = Low Smoke Zero Halogen • PE = Polyethylene • FEP = Fluorinated Ethylene Propylene • PUR = Polyurethane

DataTuff® Industrial Ethernet
Permanent Installation Cables

Category 6 • 4 Pair • Unshielded and Shielded



7953A

Part No.	Data Rates	Category	Conductor (Stranding)		Nominal OD (mm)	Jacket	Shielding		Design		Operating Temperature (°C)	Additional Features/Ratings
			Solid	Stranded			Shielded	Unshielded	Twisted Pair	Bonded-Pair		
Category 6 • 4 Pair • Unshielded and Shielded • PVC Outer Jacket												
7953A*					8.64		Overall Foil	-	-	✓		600 V UL AWM Shielded EtherNet/IP Compliant NEC: CMR, CMX-Outdoor • CEC: CMR FT4 Sunlight and Oil Resistant
7940A*					6.35		-	✓	-	✓		EtherNet/IP Compliant NEC: CMR, CMX-Outdoor • CEC: CMR FT4 Sunlight and Oil Resistant
7927A	1 Gb/s	Cat 6	AWG 23 (1)	-	6.38 x 8.61	PVC	-	✓	-	✓	-40 to +75	E-Spline Center Member for Mechanical Protection Tested to 600 MHz NEC: CMR • CEC: CMR FT4 Sunlight and Oil Resistant
11872A					12.07 x 6.73		-	✓	-	✓		Upjacketed – PVC Inner Jacket NEC: CM • CEC: CM FT1
121872A					17.37		-	✓	-	✓		Interlocked Aluminium Armor NEC: CM • CEC: HL, CMG FT4 Sunlight Resistant
Category 6 • 4 Pair • Unshielded • FEP Outer Jacket												
7931A	1 Gb/s	Cat 6	AWG 23 (1)	-	5.44	FEP	-	✓	-	✓	-75 to +150	High and Low Temp NEC: Limited Combustible FHC 25/50, CMP • CEC: CMP FT6 Outstanding Oil Res I/II Gas Resistant Sunlight Resistant

* ABS and DNV-GL approved design also available. For more details please see Belden MarineTuff Offshore and Marine Cable Solutions brochure or consult Customer Service. Compatible with Belden Metal Body RJ45 Plugs R301601 and R301602

Conductor Color Codes: Pair 1: White/Blue Stripe & Blue
Pair 2: White/Orange Stripe & Orange
Pair 3: White/Green Stripe & Green
Pair 4: White/Brown Stripe & Brown

DataTuff® Industrial Ethernet
Permanent Installation Cables

Category 7 • 4 Pair • Shielded



Part No.	Data Rates	Category	Conductor (Stranding)		Nominal OD (mm)	Jacket	Shielding		Design		Operating Temperature (°C)	Additional Features/Ratings
			Solid	Stranded			Shielded	Unshielded	Twisted Pair	Bonded-Pair		
Category 7 • 4 Pair • Shielded • PVC Outer Jacket												
74004E	10 Gb/s	Cat 7	AWG 23 (1)	–	8.00	PVC	Overall Foil + 65% Braid	–	✓	–	-40 to +80	Heavy Shielded 30 V UL AWM 20276 Sunlight and Oil Resistant Flame Retardant
Category 7 • 4 Pair • Shielded • LSZH Outer Jacket												
74004NH	10 Gb/s	Cat 7	AWG 23 (1)	–	8.00	LSZH	Overall Foil + 65% Braid	–	✓	–	-40 to +80	Heavy Shielded 30 V UL AWM 20851 Sunlight and Oil Resistant Flame Retardant – Bundle Flame Test IEC 60332-3-24 EN50266-2-4 cat C

Compatible with Belden Metal Body RJ45 Plugs R301601 and R301602

Conductor Color Codes: Pair 1: White/Blue Stripe & Blue
 Pair 2: White/Orange Stripe & Orange
 Pair 3: White/Green Stripe & Green
 Pair 4: White/Brown Stripe & Brown

PVC = Polyvinyl Chloride • LSZH = Low Smoke Zero Halogen

DataTuff® Industrial Ethernet
Moderate Flexing Cables

Category 5e • 2 Pair • Shielded



Part No.	Data Rates	Category	Conductor (Stranding)		Nominal OD (mm)	Jacket	Shielding		Design		Operating Temperature (°C)	Additional Features/Ratings
			Solid	Stranded			Shielded	Unshielded	Twisted Pair	Bonded-Pair		
Category 5e • 2 Pair • Shielded • PVC Outer Jacket												
72002E	100 Mb/s	Cat 5e	–	AWG 26 (7)	6.00	PVC	Overall Foil + 80% Braid	–	✓	–	-40 to +80	Heavy Shielded 300 V UL AWM 2464 Sunlight and Oil Resistant Flame Retardant
Category 5e • 2 Pair • Shielded • LSZH Outer Jacket												
72002NH	100 Mb/s	Cat 5e	–	AWG 26 (7)	6.00	LSZH	Overall Foil + 80% Braid	–	✓	–	-40 to +80	Heavy Shielded 300 V UL AWM 21286 Sunlight and Oil Resistant Flame Retardant
Category 5e • 2 Pair • Shielded • PUR Outer Jacket												
72002PU	100 Mb/s	Cat 5e	–	AWG 26 (7)	6.00	PUR	Overall Foil + 80% Braid	–	✓	–	-40 to +80	Heavy Shielded 300 V UL AWM 20549 Sunlight and Oil Resistant Flame Retardant FT2 Halogen Free AWM 20549

Compatible with Belden Metal Body RJ45 Plugs R301601 and R301602

Conductor Color Codes: Pair 1: White/Blue Stripe & Blue • Pair 2: White/Orange Stripe & Orange • Pair 3: White/Green Stripe & Green • Pair 4: White/Brown Stripe & Brown

DataTuff® Industrial Ethernet
Moderate Flexing Cables

Category 5e • 4 Pair • Unshielded and Shielded



Part No.	Data Rates	Category	Conductor (Stranding)		Nominal OD (mm)	Jacket	Shielding		Design		Operating Temperature (°C)	Additional Features/Ratings
			Solid	Stranded			Shielded	Unshielded	Twisted Pair	Bonded-Pair		
Category 5e • 4 Pair • Unshielded and Shielded • PVC Outer Jacket												
74002E	1 Gb/s	Cat 5e	-	AWG 26 (7)	6.50	PVC	Overall Foil + 80% Braid	-	✓	-	-40 to +80	Heavy Shielded 300 V UL AWM 2464 Sunlight and Oil Resistant Flame Retardant AWM 2464
7939A			AWG 24 (7)	8.60	-		-	✓	-40 to +75	NEC: CMR, CMX-Outdoor CEC: CMR FT4 Sunlight and Oil Resistant		
7924A			AWG 24 (7)	5.84	-		✓	-	✓		-40 to +75	
7930A			AWG 24 (7)	5.84	-		✓	✓	-		-25 to +75	
Category 5e • 4 Pair • Shielded • LSZH Outer Jacket												
74002NH	1 Gb/s	Cat 5e	-	AWG 26 (7)	6.50	LSZH	Overall Foil + 80% Braid	-	✓	-	-40 to +80	Heavy Shielded 300 V UL AWM 21286 Sunlight and Oil Resistant Flame Retardant
Category 5e • 4 Pair • Shielded • PUR Outer Jacket												
74002PU	1 Gb/s	Cat 5e	-	AWG 26 (7)	6.50	PUR	Overall Foil + 80% Braid	-	✓	-	-40 to +80	Heavy Shielded 300 V UL AWM 20549 Sunlight and Oil Resistant Flame Retardant FT2 Halogen Free AWM 20549

Compatible with Belden Metal Body RJ45 Plugs R301601 and R301602

Conductor Color Codes: Pair 1: White/Blue Stripe & Blue • Pair 2: White/Orange Stripe & Orange • Pair 3: White/Green Stripe & Green • Pair 4: White/Brown Stripe & Brown

PVC = Polyvinyl Chloride • LSZH = Low Smoke Zero Halogen • PUR = Polyurethane

DataTuff® Industrial Ethernet
Moderate Flexing Cables

Category 7 • 4 Pair • Shielded



Part No.	Data Rates	Category	Conductor (Stranding)		Nominal OD (mm)	Jacket	Shielding		Design		Operating Temperature (°C)	Additional Features/Ratings
			Solid	Stranded			Shielded	Unshielded	Twisted Pair	Bonded-Pair		
Category 7 • 4 Pair • Shielded • PUR Outer Jacket												
74005E						PVC						Heavy Shielded 30 V UL AWM 20121 Sunlight and Oil Resistant Flame Retardant
74005NH	10 Gb/s	Cat 7	–	AWG 26 (7)	6.80	LSNH	Overall Foil + 65% Braid	–	✓	–	-40 to +80	Heavy Shielded 30 V UL AWM 20851 Sunlight and Oil Resistant Flame Retardant Halogen Free
74005PU						PUR						Heavy Shielded 30 V UL AWM 21292 Sunlight and Oil Resistant Flame Retardant FT2 Halogen Free

Compatible with Belden Metal Body RJ45 Plugs R301601 and R301602

Conductor Color Codes: Pair 1: White/Blue Stripe & Blue
 Pair 2: White/Orange Stripe & Orange
 Pair 3: White/Green Stripe & Green
 Pair 4: White/Brown Stripe & Brown

PUR = Polyurethane

DataTuff® Industrial Ethernet
Continuous Flexing Cables

Category 5e • 4 Pair • Shielded



Part No.	Data Rates	Category	Conductor (Stranding)		Nominal OD (mm)	Jacket	Shielding		Design		Operating Temperature (°C)	Additional Features/Ratings
			Solid	Stranded			Shielded	Unshielded	Twisted Pair	Bonded-Pair		
Category 5e • 4 Pair • Shielded • TPE Outer Jacket												
7938A	1 Gb/s	Cat 5e	–	AWG 24 (32)	8.74	TPE	Overall Foil + 85% Braid	–	–	✓	-40 to +80	10 Million Continuous Flex Cycles, Trailing Weldsplatter Resistant CEC: FT1 Sunlight and Oil Resistant AWM 20626
Category 5e • 4 Pair • Shielded • PUR Outer Jacket												
74003PU					6.65							2 Million Continuous Flex Cycles, Trailing 300 V UL AWM 20549 Sunlight and Oil Resistant Flame Retardant FT2 Halogen Free AWM 20549
	1 Gb/s	Cat 5e	–	AWG 26 (19)		PUR	Overall Foil + 80% Braid	–	✓	–	-40 to +80	2 Million Continuous Flex Cycles, Torsion 300 V UL AWM 20549 Weldsplatter Resistant Sunlight and Oil Resistant Flame Retardant FT2 Halogen Free
74009PU					6.40							

Compatible with Belden Metal Body RJ45 Plugs R301601 and R301602

Conductor Color Codes: Pair 1: White/Blue Stripe & Blue
Pair 2: White/Orange Stripe & Orange
Pair 3: White/Green Stripe & Green
Pair 4: White/Brown Stripe & Brown

TPE = Thermoplastic Elastomer • PUR = Polyurethane

DataTuff® PROFINET
Permanent Installation Cables

Category 5e • 2 Pair (Quad) Design • Shielded



Part No.	Data Rates	Category	Conductor (Stranding)		Nominal OD (mm)	Jacket	Shielding		Operating Temperature (°C)	Additional Features/Ratings
			Solid	Stranded			Shielded	Unshielded		
Category 5e • 2 Pair (Quad) • Shielded • PVC Outer Jacket										
70006E	100 Mbit/s	Cat 5e	AWG 22 (1)	–	6.50	PVC	Overall Foil + 85% Braid	–	-40 to +80	Heavy Shielded 300 V AWM 2464 Oil Resistant Flame Retardant
7960A										Heavy Shielded Oil Resistant, Sunlight Resistant PLTC listed 600 V AWM C(UL) CMG FT4, IEEE1202/383, VW-1 and IEC 60332-1-2 flame ratings
Category 5e • 2 Pair (Quad) • Shielded • LSZH Outer Jacket										
70006NH	100 Mbit/s	Cat 5e	AWG 22 (1)	–	6.50	FRNC	Overall Foil + 85% Braid	–	-40 to +70	Heavy Shielded 300 V UL AWM 21286 Sunlight and Oil Resistant VDE 60811-2-1 Flame Retardant

PVC = Polyvinyl Chloride • FRNC = Fire Retardant, Non-Corrosive

DataTuff® PROFINET
Moderate Flexing Cables

Category 5e • 2 Pair (Quad) Design • Shielded



Part No.	Data Rates	Category	Conductor (Stranding)		Nominal OD (mm)	Jacket	Shielding		Operating Temperature (°C)	Additional Features/Ratings
			Solid	Stranded			Shielded	Unshielded		
Category 5e • 2 Pair (Quad) • Shielded • PVC Outer Jacket										
70007E	100 Mbit/s	Cat 5e	–	AWG 22 (7)	6.50	PVC	Overall Foil + 85% Braid	–	-40 to +80	Heavy Shielded 300 V UL AWM 2464 Oil Resistant Flame Retardant
7961A										Heavy Shielded Oil Resistant, Sunlight Resistant PLTC listed 600 V AWM C(UL) CMG FT4, IEEE1202/383, VW-1 and IEC 60332-1-2 flame ratings
Category 5e • 2 Pair (Quad) • Shielded • LSZH Outer Jacket										
70007NH	100 Mbit/s	Cat 5e	–	AWG 22 (7)	6.50	FRNC	Overall Foil + 85% Braid	–	-25 to +80	Heavy Shielded 300 V UL AWM 21286 Sunlight and Oil Resistant Flame Retardant
Category 5e • 2 Pair (Quad) • Shielded • PUR Outer Jacket										
70007PU	100 Mbit/s	Cat 5e	–	AWG 22 (7)	6.50	PUR	Overall Foil + 85% Braid	–	-40 to +80	Heavy Shielded 300 V UL AWM 20549 Sunlight and Oil Resistant Flame Retardant

PVC = Polyvinyl Chloride • FRNC = Fire Retardant, Non-Corrosive • PUR = Polyurethane

DataTuff® PROFINET
Continuous Flexing Cables

Category 5e • 2 Pair (Quad) Design • Shielded



Part No.	Data Rates	Category	Conductor (Stranding)		Nominal OD (mm)	Jacket	Shielding		Operating Temperature (°C)	Additional Features/Ratings
			Solid	Stranded			Shielded	Unshielded		
Category 5e • 2 Pair (Quad) • Shielded • PUR Outer Jacket										
70008PU	100 Mbit/s	Cat 5e	–	AWG 22 (19)	6.50	PUR	Overall Foil + 85% Braid	–	-40 to +80	5 Million Continuous Flex Cycles, Trailing 300 V UL AWM 20549 Sunlight and Oil Resistant Flame Retardant FT2 Halogen Free AWM 20549
70009PU										2 Million Continuous Flex Cycles, Torsion 300 V UL AWM 20549 Sunlight and Oil Resistant Weldsplatter Resistant Flame Retardant FT2 Halogen Free AWM 20549
Category 5e • 2 Pair (Quad) • Shielded • TPE Outer Jacket										
7962A	100 Mbit/s	Cat 5e	–	AWG 22 (19)	6.50	TPE	Overall Foil + 85% Braid	–	-40 to +80	5 Million Continuous Flex Cycles, Trailing Heavy Shielded Oil Resistant, Sunlight Resistant Weldsplatter Resistant CMX Outdoor PLTC listed 600 V AWM C(UL) CM, FT1 flame ratings

TPE = Thermoplastic Elastomer • PUR = Polyurethane

Industrial Data and Process Automation DataTuff® Industrial Ethernet Patch Cords



Section Table of Contents

Industrial Data and Process Automation	
DataTuff® Industrial Ethernet Patch Cords	
Overview	270
DataTuff® Industrial Ethernet Patch Cords	
Twisted Pair Cables	271–272
Bonded Pair Cables	273–274



DataTuff® Industrial Ethernet Patch Cords



Safety and uptime are key in all mission-critical applications, this is why Belden's DataTuff® Industrial Ethernet Patch Cords are designed to meet stringent system requirements, providing resilient data throughput.

Product Features

- Industrial Ethernet and PROFINET patch cords
- RJ 45 to RJ 45, IP20 and IP67 combinations
- Solid and stranded constructions
- Shielded and unshielded
- Heavy-duty oil and sunlight resistant PVC, FRNC and PUR jackets
- CMX/outdoor rated designs

Benefits

- Industry-approved, standard connector options
- Proven, state-of-the-art Bonded-Pair options
- Product consistency: manufactured in ISO certified manufacturing facilities, Belden's state-of-the-art processes ensure quality in each product. Product consistency for ease of termination and assembly is a mainstay of our products

Applications

The DataTuff® range is primarily built and designed for harsh/mission-critical applications. The products are used in automation, machine building, food/beverage, petro-chemical, and many more industrial markets.

DataTuff® Industrial Ethernet Patch Cords
Twisted Pair Cables

Permanent Installation



Part No.	Data Rates	Patch Cord Category	Conductor (Stranding)		No. of Pairs	Jacket			Shielding		Design Twisted Pair	Connectivity			
			Solid	Stranded		PVC	FRNC	PUR	Shielded	Unshielded		Plug End 1	Protection End 1	Plug End 2	Protection End 2
INDUSTRIAL ETHERNET															
CA00641	100 Mb/s	Cat 5e	AWG 24 (1)	-	2	✓	-	-	Overall Foil + 80% Braid	-	✓	RJ45	IP20	RJ45	IP20
CA00642						-	✓	-							
CA00600	1 Gb/s	Cat 5e	AWG 24 (1)	-	4	✓	-	-	Overall Foil + 80% Braid	-	✓	RJ45	IP20	RJ45	IP20
CA00643						-	✓	-							
CA00664	10 Gb/s	Cat 6A	-	AWG 26 (7)	4	✓	-	-	Overall Foil + 65% Braid	-	✓	RJ45	IP20	RJ45	IP20
CA00665						-	✓	-							

Permanent Installation

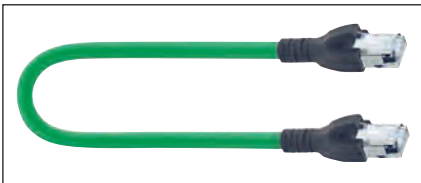

Part No.	Data Rates	Patch Cord Category	Conductor (Stranding)		No. of Pairs	Jacket			Shielding		Design Quad	Connectivity			
			Solid	Stranded		PVC	FRNC	PUR	Shielded	Unshielded		Plug End 1	Protection End 1	Plug End 2	Protection End 2
PROFINET															
CA00656	100 Mb/s	Cat 5e	AWG 22 (1)	-	Quad	✓	-	-	Overall Foil + 85% Braid	-	✓	RJ45	IP20	RJ45	IP20
CA00658						-	✓	-							

PVC = Polyvinyl Chloride • FRNC = Fire Retardant, Non-Corrosive • PUR = Polyurethane

DataTuff® Industrial Ethernet Patch Cords

Twisted Pair Cables

Moderate Flexing



Part No.	Data Rates	Patch Cord Category	Conductor (Stranding)		No. of Pairs	Jacket			Shielding		Design Twisted Pair	Connectivity			
			Solid	Stranded		PVC	FRNC	PUR	Shielded	Unshielded		Plug End 1	Protection End 1	Plug End 2	Protection End 2
INDUSTRIAL ETHERNET															
CA00660	100 Mb/s	Cat 5e	-	AWG 26 (7)	2	✓	-	-	Overall Foil + 80% Braid	-	✓	RJ45	IP20	RJ45	IP20
CA00661						-	✓	-							
CA00613	1 Gb/s					✓	-	-							
CA00630			-	✓	-										
CA00652	10 Gb/s	Cat 6A	-	AWG 26 (7)	4	-	-	✓	Overall Foil + 65% Braid	-	✓	RJ45	IP20	RJ45	IP20

Moderate Flexing



Part No.	Data Rates	Patch Cord Category	Conductor (Stranding)		No. of Pairs	Jacket			Shielding		Design Quad	Connectivity			
			Solid	Stranded		PVC	FRNC	PUR	Shielded	Unshielded		Plug End 1	Protection End 1	Plug End 2	Protection End 2
PROFINET															
CA00730	100 Mb/s	Cat 5e	-	AWG 22 (7)	Quad	✓	-	-	Overall Foil + 85% Braid	-	✓	RJ45	IP20	RJ45	IP20
CA00735						-	✓	-							

PVC = Polyvinyl Chloride • FRNC = Fire Retardant, Non-Corrosive • PUR = Polyurethane

DataTuff® Industrial Ethernet Patch Cords
Bonded Pair Cables

Category 6 • Standard RJ45 Connectors



- 4-Pair Cable
- 23 AWG Solid BC Conductors
- Heavy-Duty Oil- & Sunlight-Resistant Black Jackets
- NEC: CMR, CMX-Outdoor
- CEC: CMR FT4
- IP67 interface complies with the EtherNet/IP specification (IEC 61076-3-106 Variant 1)

Part No.				Length	
Unshielded Belden Bonded-Pair Cable 7940A		Shielded Belden Bonded-Pair Cable 7953A		Meters	Feet
IP67 (Tethered Cap)	IP20 (No Cap)	IP67 (Tethered Cap)	IP20 (No Cap)		
E600001 010S1	E601001 010S1	E604001 010S1	E605001 010S1	1	3.3
E600002 010S1	E601002 010S1	E604002 010S1	E605002 010S1	2	6.6
E600003 010S1	E601003 010S1	E604003 010S1	E605003 010S1	3	9.8
E600005 010S1	E601005 010S1	E604005 010S1	E605005 010S1	5	16.4
E600025 010S1	—	E604025 010S1	—	25	82

Category 6 • Ruggedized Metal-Body RJ45 Connectors



- 4-Pair Cable
- 23 AWG Solid BC Conductors
- Heavy-Duty Oil- & Sunlight-Resistant Black Jackets
- NEC: CMR, CMX-Outdoor
- CEC: CMR FT4

Part No.		Length	
Unshielded Belden Bonded-Pair Cable 7940A	Shielded Belden Bonded-Pair Cable 7953A	Meters	Feet
IP20 (No Cap)	IP20 (No Cap)		
R601001 010S1	R605001 010S1	1	3.3
R601002 010S1	R605002 010S1	2	6.6
R601003 010S1	R605003 010S1	3	9.8
R601005 010S1	R605005 010S1	5	16.4

BC = Bare Copper

DataTuff® Industrial Ethernet Patch Cords

Bonded Pair Cables

Category 5e • Standard RJ45 Connectors



- 4-Pair Cable
- Heavy-Duty Oil- & Sunlight-Resistant Black Jackets
- NEC: CMR, CMX-Outdoor
- CEC: CMR FT4
- IP67 interface complies with the EtherNet/IP specification (IEC 61076-3-106 Variant 1)

Solid BC Conductors

Part No.				Length	
Unshielded Belden Bonded-Pair Cable 7923A		Shielded Belden Bonded-Pair Cable 7929A			
IP67 (Tethered Cap)	IP20 (No Cap)	IP67 (Tethered Cap)	IP20 (No Cap)	Meters	Feet
E500001 010S1	E501001 010S1	E504001 010S1	E505001 010S1	1	3.3
E500002 010S1	E501002 010S1	E504002 010S1	E505002 010S1	2	6.6
E500003 010S1	E501003 010S1	E504003 010S1	E505003 010S1	3	9.8
E500005 010S1	E501005 010S1	E504005 010S1	E505005 010S1	5	16.4
E500025 010S1	—	E504025 010S1	—	25	82

Stranded BC Conductors

Part No.				Length	
Unshielded Belden Bonded-Pair Cable 7924A		Shielded Belden Bonded-Pair Cable 7939A			
IP67 (Tethered Cap)	IP20 (No Cap)	IP67 (Tethered Cap)	IP20 (No Cap)	Meters	Feet
E502001 010S1	E503001 010S1	E506001 010S1	E507001 010S1	1	3.3
E502002 010S1	E503002 010S1	E506002 010S1	E507002 010S1	2	6.6
E502003 010S1	E503003 010S1	E506003 010S1	E507003 010S1	3	9.8
E502005 010S1	E503005 010S1	E506005 010S1	E507005 010S1	5	16.4
E502025 010S1	—	E506025 010S1	—	25	82



Industrial Data and Process Automation RailTuff™ Railway Approved Industrial Ethernet

Section Table of Contents

Industrial Data and Process Automation	
RailTuff™ Railway Approved Industrial Ethernet	
Overview	276
RailTuff™ Railway Approved Industrial Ethernet	277

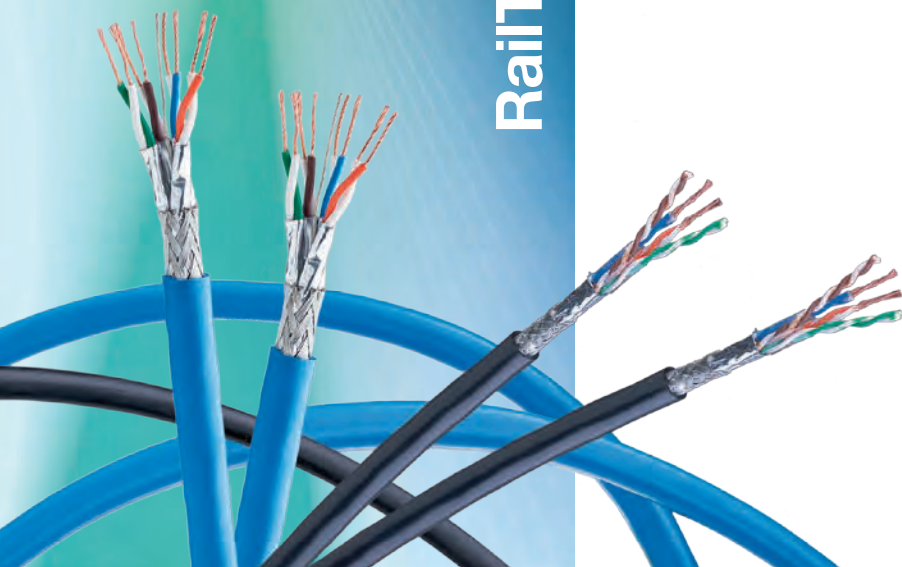

RailTuff™ Railway Approved Industrial Ethernet



Belden RailTuff™ Railway Ethernet Data Cables offer enhanced system performance and a greater passenger travel experience. Belden has a complete portfolio of data communication cables in the railway transportation environment, covering from 100 Mb/s, to 1 Gb/s and now also 10 Gb/s.

Product Features

- Cat 7 10 Gb/s transmission performance
- Cat 5e 4-pair and quad design
- International railway standards approval: EN 45545-2 and ISO/IEC 11801, EN 50155, EN 50155:2007, DIN 5510-2, IEC 61156-6
- Max. operating temperature of +90 °C
- Premium X-Linked LSZH Outer Jacket
- Highly stranded copper conductor
- High screen coverage + Belden Beldfoil®
- Small bending radius
- Robust design

Benefits

Future Proof

- Up to 10 Gb/s transmission performance (BE43802)

Safety

- Maximum operating temperatures on the market: +90 °C, exceeding the +85 °C short term temp. requirement in Class TX of the EN 50155 railway standard (BE43802)

Efficiency

- Operational efficiency with 19-strand copper conductors (BE43802)
- Small bend radius allows for easy and risk free installation within limited spaces

Full Product Range

- Complete portfolio of data communication cables in the railway transportation environment: 100 Mb/s, 1 Gb/s, 10 Gb/s bandwidth

Applications

The RailTuff™ range is designed for the transmission of data and signals using Ethernet technology, for on-board applications; effectively future proofing the on board Ethernet backbone and enabling compliance with the new series of IEC standards; IEC EN 61375 "Train Communication Network (TCN)" and IEC EN 62580 "On-board Multimedia and Telematic Subsystems for Railways".

Key areas of application include:

- Train Consist Network (TCN)
- Passenger information and entertainment
- Multimedia Services
- Security and surveillance
- Train diagnostics
- Fare collection and ticketing
- Communications Based Train Control (CBTC)

RailTuff™ Railway Approved Industrial Ethernet

Meeting International Railway Standards

Belden RailTuff™ data cables are designed and manufactured in accordance with the following international railway standards:

- EN 50155:2007
 - Railway applications
 - Class TX (-40 °C to +85 °C)
- EN 45545-2:2013
 - Fire protection on railway vehicles
 - Class R15 and R16 (Hazard Level 1-3)
 - IEC 60332-1-2
 - Toxicity test: EN 50305
 - Flame test: EN 50266-2-5
 - IEC 60332-3-25 Cat D
 - EN 61034-2
 - NF X70-100-1 & NF X70-100-2
- DIN 5510-2
 - Preventive fire protection in railway vehicles
 - Protection Level 1-4
 - IEC 60332-1-2
 - IEC 50266-2-5 Cat D
- ISO/IEC 11801 2nd edition IEC 61156-6

Part No.	Data Rates	Category	Conductor (Stranding)		Nominal OD (mm)	Jacket	Shielding		Design		Operating Temperature (°C)	Additional Features/Ratings
			Solid	Stranded			Shielded	Unshielded	Twisted Pair	Quad		



PROFINET Cat 5e • 2 Pair (Quad) • Shielded • Premium X-Linked LSZH Outer Jacket												
BE43769	100 Mbit/s	Cat 5e	–	AWG 22 (19)	6.70	Premium LSZH, Insulation and Jacket cross-linked (by e-beam)	Overall Foil + 80% Braid	–	–	✓	-40 to +90	Heavy Shielded DIN 5510-2 level 1 to 4, EN 50155 Flame Resistance acc EN/TS 45545, IEC 60332-1-2, EN 50305 & IEC 60332-3-25 cat D EN/TS 45545 (Class R15 and R16 HL3) Oil Resistance



Industrial Ethernet Cat 5e • 4 Pair • Shielded • Premium X-Linked LSZH Outer Jacket												
BE43800	1 Gb/s	Cat 5e	–	AWG 26 (19)	6.70	Premium LSZH, Insulation and Jacket cross-linked (by e-beam)	Overall Foil + 85% Braid	–	✓	–	-40 to +90	Heavy Shielded DIN 5510-2 level 1 to 4, EN 50155 Flame Resistance acc EN/TS 45545, IEC 60332-1-2, EN 50305 & IEC 60332-3-25 cat D EN/TS 45545 (Class R15 and R16 HL3) Oil Resistance



Industrial Ethernet Cat 7 • 4 Pair • Shielded • Premium X-Linked LSZH Outer Jacket												
BE43802	10 Gb/s	Cat 7	–	AWG 24 (19)	8.10	Premium LSZH, Insulation and Jacket cross-linked (by e-beam)	Overall Foil + 80% Braid	–	✓	–	-40 to +80	Heavy Shielded DIN 5510-2 level 1 to 4, EN 50155 Flame Resistance acc EN/TS 45545, IEC 60332-1-2, EN 50305 & IEC 60332-3-25 cat D EN/TS 45545 (Class R15 and R16 HL3) Oil Resistance

LSZH = Low Smoke Zero Halogen



The Railway approved cable range ensures the highest level of reliability, quality and performance.

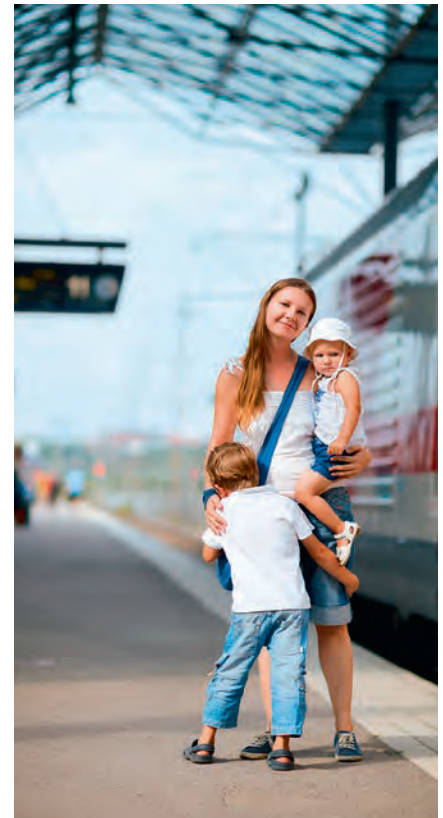



Optical Fiber Central and Multi Loose Tube

Section Table of Contents

Optical Fiber	
Overview	280
Loose Tube Optical Characteristics	281
Construction Lookup Table	282
Part Number Coding	283
Central Loose Tube	284–309
Multi Loose Tube	310–327
Technical Information	328–330



Optical Fiber – Overview



Belden's central and multi loose tube fiber cables are ideal for industrial and underground environments. Belden's fiber cabling range is the culmination of our experience and expertise in a variety of applications, including oil and gas, transportation, power transmission and generation, and many more.

Product Features

- Central loose tube and multi loose tube cables
- Available in sizes from 2 to 144 fibers
- Jelly filled (non-dripping and silicon-free) loose tubes with primary coated optical fibers ($\text{Ø } 250 \pm 15 \mu\text{m}$)
- Full dielectric construction, immune to lightning and electromagnetic interference (EMC-safe), spark-free and require no grounding
- Installation-friendly thanks to the cable core which is kept free of grease (dry interstices)
- High mechanical and full rodent protection provided by Steel Wire armor (SWA), Corrugated Steel Tape (CST) armor, Fiber Reinforced Plastic (FRP) armor, Steel Wire Braid (SWB) armor or Glass Yarn Strength Elements
- Length marking in meters for easy determination of the cable length

Benefits

Involved in the development of optical fiber components for over 40 years, Belden is a leading supplier of high-quality, cost-effective optical fiber cabling systems. Belden's fiber cables are designed to offer reduced complexity, increased flexibility, and rapid installation for maximum cost effectiveness.

Applications

Belden's fiber central and multi loose tube cables are suitable for a wide range of applications, including:

- For outdoor and indoor use in structured (data) wiring systems such as industrial backbone, campus backbone, factory backbone (riser) and/or horizontal cabling, networks within automation environments, video surveillance, cable TV and/or broadcast
- Easy to install in ducts, tunnels and trenches by means of compressed air or pulling wire
- Suitable for direct burial

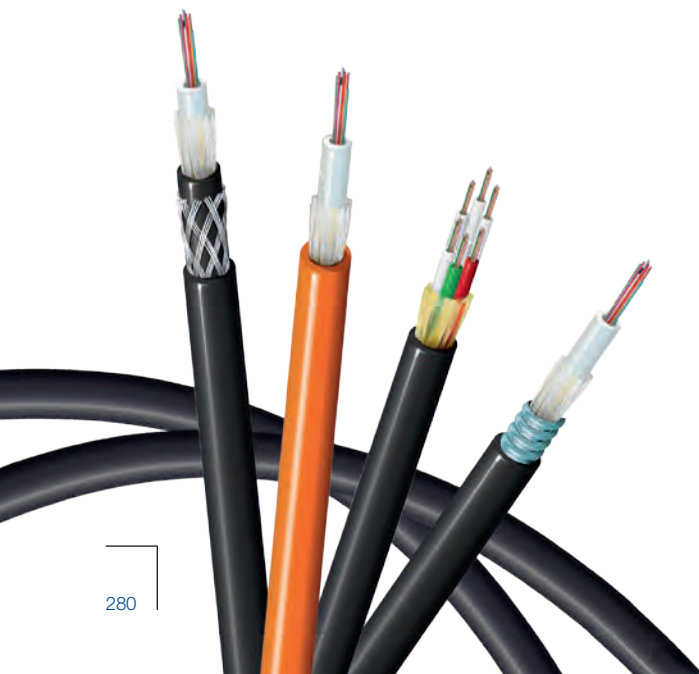

Belden Optical Fiber Cables

Reduce Complexity and Increase Flexibility

Today's advanced networks are diverse and almost always complex. The right way ahead is to future-proof these networks and to take precautions to protect them against anything that will create problems, damage or disruption. That means matching the right hardware with the right cabling to guarantee performance – and that means choosing fiber optic cable. Optical fiber cables offer many benefits: high bandwidth and transmission speed, the potential for network growth, extended reach, fault tolerance, greater data security and support for Gigabit and multi-Gigabit protocols and networked applications.

Fiber Types

Loose Tube Optical Characteristics

European Part Number Coding, Position 5	Fiber-Type	Mode-Field/Cladding Diameter (µm)	Wave-length (nm)	Attenuation [®] average/max. (dB/km)	Dispersion (ps/nm-km)	PMD ^A (ps/km)	Cable Cut-off Wave-length (nm)
---	------------	-----------------------------------	------------------	---	-----------------------	--------------------------	--------------------------------

Characteristics (cabled) Single-Mode • Matched-Cladded Optical Fibers according to ITU

8	9/125	9.2 ± 0.4	1310	0.33/0.34	≤ 3.2	≤ 0.06	≤ 1260
	G.652D & G.657A1 BI OS2	125.0 ± 0.7	1550	0.18/0.19	≤ 17.0		
			1625	0.20/0.24			
7	9/125	8.4 ± 0.6	1550	0.2/0.22	≤ 4.5	≤ 0.04	≤ 1260
	G.655 C & D	125.0 ± 0.7	1625	0.21/0.24	≤ 7.9		

Note A: Link design value

Note B: Due to cabling the optical attenuation values can increase with max. 0.05 dB/km

European Part Number Coding, Position 5	Fiber-Type	Core/Cladding Diameter (µm)	Wave-length (nm)	Attenuation ^c average/max. (dB/km)	Bandwidth (MHz-km)	Ethernet Performance (m)		Num. Apert. (µm)	Refractive Index
						1 GBE	10 GBE		

Characteristics (cabled) Multi-Mode • Graded-Index Optical Fibers according to IEC 60793

1	62.5/125 OM1	62.5 ± 2.5	850	2.7/3.0	≥ 200	220	33	0.275 ± 0.015	1.495
		125.0 ± 1.0	1300	0.7/0.8	≥ 600	550	300		1.490
2	50/125 OM2	50.0 ± 2.5	850	2.3/2.5	≥ 500	600	83	0.200 ± 0.015	1.481
		125.0 ± 1.0	1300	0.5/0.6	≥ 500	600	300		1.476
D	50/125 OM3 BI	50.0 ± 2.5	850	2.3/2.5	≥ 1500	1000	300	0.200 ± 0.015	1.482
		125.0 ± 1.0	1300	0.5/0.6	≥ 500	550	300		1.477
E	50/125 OM4 BI	50.0 ± 2.5	850	2.3/2.5	≥ 3500	1100	550	0.200 ± 0.015	1.482
		125.0 ± 1.0	1300	0.5/0.6	≥ 500	550	300		1.477

Note C: Due to cabling the optical attenuation values can increase with max. 0.4 dB/km

Belden Optical Fiber Cables

Construction Lookup Table

Central Loose Tube Cables		
Construction	Description	Page
GUSN, GUSL, GURN, GUVN	CLT Universal	284
GOSN, GORN, GOVN	CLT Outdoor	286
GMSN	CLT Outdoor	288
GUCN, GUCB	CLT Universal CST	290
GOCN, GOCB	CLT Outdoor CST	292
GUDN, GUDB	CLT Universal CST	294
GODN, GODB	CLT Outdoor CST	296
GUHA	CLT Universal SWB	298
GOHN	CLT Outdoor SWB	300
GUWN, GUWB	CLT Universal SWA	302
GOWN, GOWB	CLT Outdoor SWA	304
GUFN, GUFB	CLT Universal FRP	306
GOFN, GOFB	CLT Outdoor FRP	308

Multi Loose Tube Cables		
Construction	Description	Page
GCRG, GCRD, GCRE, GCRF	MLT Universal	310
GBRG, GBRD, GBRE, GBRF	MLT Outdoor	312
GDRG, GDRD, GDRE, GDRF	MLT Outdoor	312
GCCG, GCCD, GCCE, GCCF	MLT Universal CST	314
GBCG, GBCD, GBCE, GBCF	MLT Outdoor CST	316
GDCG, GDGD, GDCE, GDGF	MLT Outdoor CST	316
GCDG, GCDD, GCDE, GCDF	MLT Universal CST	318
GBDG, GBDD, GBDE, GBDF	MLT Outdoor CST	320
GDDG, GDDD, GDDE, GDDF	MLT Outdoor CST	320
GCWG, GCWD	MLT Universal SWA	322
GBWG, GBWD	MLT Outdoor SWA	324
GDWG, GDWD	MLT Outdoor SWA	324
GAAG, GAAD, GAAE	MLT Outdoor ADSS	326

Part Number Coding

The part numbers for the European Optical Fiber cables have the following structure:

- 4 positions to describe the construction
- 1 position to describe the fiber type
- 2 positions to describe the fiber count

Example

Construction				Fiber Type	Fiber Count	
1	2	3	4	5	6	7
G	C	R	G	1	0	6

In this example the

- Construction is: **GCRG**
- Jacket type is: **2**
- Fiber type is: **1**
- Fiber count is: **6**

Jacket Type Coding on Position 2

Position 2	Jacket Type
A	Polyethylene
B	Polyethylene
C	Halogen Free
D	Polyethylene
O	Polyethylene
U	Halogen Free

For both the PE and LSZH versions Termite Protection options are available by means of adding a PA (nylon) jacket, either as an outer jacket (for PE versions) or double jackets, PA and additional LSZH outer jacket, for LSZH versions. Please contact Customer Service for more information.

Universal Central Loose Tube Cable with Rodent Protection, Single Jacket

GUSN, GUSL, GURN, GUVN

A/I-DQ(ZN)BH



Applications

- For outdoor and indoor use in structured (data) wiring systems such as campus backbone
- Easy to install in ducts, tunnels and trenches by means of compressed air or pulling wire
- Suitable for direct burial

Features & Benefits

- Available in sizes from 2 to 24 fibers
- Jelly filled (non-dripping and silicon-free) loose tube with primary coated optical fibers ($\text{Ø } 250 \pm 15 \mu\text{m}$)
- Full dielectric construction, no grounding required
- Rodent protected by means of Glass Yarn Strength Elements
- Halogen Free jacket
- Length marking in meters for easy determination of the cable length

Cross Section

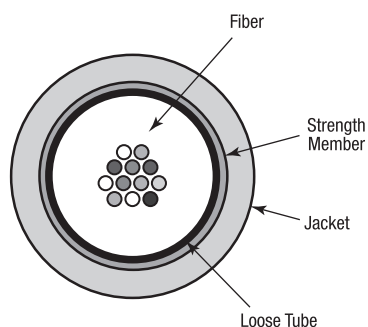

Specifications

IEC 60794-1-2	
Crush Resistance Installation (Short Term):	15 kN/m
Min. Bend Radius installation (E6):	20 x Ø
Min. Bend Radius operation (E11):	10 x Ø
Temperature Range (F1):	
– Transport/Storage	-30 °C to +70 °C
– Installation	-5 °C to +50 °C
– Operation	-30 °C to +70 °C
Watertightness (F5):	Pass
Other	
Flame Retardant:	
– GUSN, GURN, GUVN	IEC 60332-1
– GUSL	IEC 60332-3-24
Halogen Free:	IEC 60754-1
Non Corrosive:	IEC 60754-2
Smoke Density:	IEC 61034-2

Characteristics

Loose Tube	Fiber Count	Diameter (mm)	Weight (kg/km)	Tensile Strength (short term) N	Tensile Strength (permanent) N	Fire Load (kJ/m)
IEC 60794-1-2				E1	E1	
GUSN*xx	2 to 24	5.8	37	1250	420	550
GUSL*xx	2 to 24	6.5	47	1250	420	580
GURN*xx	2 to 24	7.1	55	3000	1000	755
GUVN*xx	2 to 24	7.8	67	4000	1300	928

Ordering Information

Fiber Type/Count	2	4	6	8	12	16	24
GUSN							
62.5/125-OM1	GUSN102	GUSN104	GUSN106	GUSN108	GUSN112	GUSN116	GUSN124
50/125-OM2	GUSN202	GUSN204	GUSN206	GUSN208	GUSN212	GUSN216	GUSN224
50/125-OM3	GUSND02	GUSND04	GUSND06	GUSND08	GUSND12	GUSND16	GUSND24
50/125-OM4	GUSNE02	GUSNE04	GUSNE06	GUSNE08	GUSNE12	GUSNE16	GUSNE24
9/125 ITU G.652D	GUSN802	GUSN804	GUSN806	GUSN808	GUSN812	GUSN816	GUSN824
9/125 ITU G.655 C & D	GUSN702	GUSN704	GUSN706	GUSN708	GUSN712	GUSN716	GUSN724
GUSL							
62.5/125-OM1	GUSL102	GUSL104	GUSL106	GUSL108	GUSL112	GUSL116	GUSL124
50/125-OM2	GUSL202	GUSL204	GUSL206	GUSL208	GUSL212	GUSL216	GUSL224
50/125-OM3	GUSLD02	GUSLD04	GUSLD06	GUSLD08	GUSLD12	GUSLD16	GUSLD24
50/125-OM4	GUSLE02	GUSLE04	GUSLE06	GUSLE08	GUSLE12	GUSLE16	GUSLE24
9/125 ITU G.652D	GUSL802	GUSL804	GUSL806	GUSL808	GUSL812	GUSL816	GUSL824
9/125 ITU G.655 C & D	GUSL702	GUSL704	GUSL706	GUSL708	GUSL712	GUSL716	GUSL724
GURN							
62.5/125-OM1	GURN102	GURN104	GURN106	GURN108	GURN112	GURN116	GURN124
50/125-OM2	GURN202	GURN204	GURN206	GURN208	GURN212	GURN216	GURN224
50/125-OM3	GURND02	GURND04	GURND06	GURND08	GURND12	GURND16	GURND24
50/125-OM4	GURNE02	GURNE04	GURNE06	GURNE08	GURNE12	GURNE16	GURNE24
9/125 ITU G.652D	GURN802	GURN804	GURN806	GURN808	GURN812	GURN816	GURN824
9/125 ITU G.655 C & D	GURN702	GURN704	GURN706	GURN708	GURN712	GURN716	GURN724
GUVN							
62.5/125-OM1	GUVN102	GUVN104	GUVN106	GUVN108	GUVN112	GUVN116	GUVN124
50/125-OM2	GUVN202	GUVN204	GUVN206	GUVN208	GUVN212	GUVN216	GUVN224
50/125-OM3	GUVND02	GUVND04	GUVND06	GUVND08	GUVND12	GUVND16	GUVND24
50/125-OM4	GUVNE02	GUVNE04	GUVNE06	GUVNE08	GUVNE12	GUVNE16	GUVNE24
9/125 ITU G.652D	GUVN802	GUVN804	GUVN806	GUVN808	GUVN812	GUVN816	GUVN824
9/125 ITU G.655 C & D	GUVN702	GUVN704	GUVN706	GUVN708	GUVN712	GUVN716	GUVN724
GUSN • GURN • GUVN							
Std. plywood reel (non-returnable)			Ø 800 x 475 mm, Weight 7.65 kg and Ø 1000 x 530 mm, Weight 18.0 kg				
Std. delivery length			2100 ± 100 m and 4100 ± 100 m				

Fiber Color Coding

1	Red	5	Green	9	Orange	13	Red + ring	17	Green + ring	21	Orange + ring
2	Natural	6	Violet	10	Turquoise	14	Natural + ring	18	Violet + ring	22	Turquoise + ring
3	Yellow	7	Brown	11	Pink	15	Yellow + ring	19	Brown + ring	23	Pink + ring
4	Blue	8	Black	12	White	16	Blue + ring	20	Grey + ring	24	White + ring

Outdoor Central Loose Tube Cable with Rodent Protection, Single Jacket

GOSN, GORN, GOVN

A-DQ(ZN)B2Y

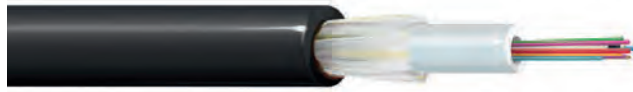

Applications

- For outdoor use in structured (data) wiring systems such as campus backbone
- For outdoor use in networks for telecom, cable TV and/or broadcast
- Easy to install in ducts, tunnels and trenches by means of compressed air or pulling wire
- Suitable for direct burial

Features & Benefits

- Available in sizes from 2 to 24 fibers
- Jelly filled (non-dripping and silicon-free) loose tube with primary coated optical fibers ($\varnothing 250 \pm 15 \mu\text{m}$)
- Full dielectric construction, no grounding required
- Rodent protected by means of Glass Yarn Strength Elements
- Polyethylene jacket
- Length marking in meters for easy determination of the cable length

Cross Section

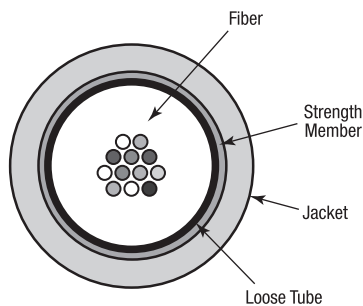

Specifications

IEC 60794-1-2	
Crush Resistance Installation (Short Term):	15 kN/m
Min. Bend Radius installation (E6):	20 x \varnothing
Min. Bend Radius operation (E11):	10 x \varnothing
Temperature Range (F1):	
– Transport/Storage	-30 °C to +70 °C
– Installation	-5 °C to +50 °C
– Operation	-30 °C to +70 °C
Watertightness (F5):	Pass

Characteristics

Loose Tube	Fiber Count	Diameter (mm)	Weight (kg/km)	Tensile Strength (short term) N	Tensile Strength (permanent) N	Fire Load (kJ/m)
IEC 60794-1-2				E1	E1	
GOSN*xx	2 to 24	5.8	28	1250	420	762
GORN*xx	2 to 24	7.1	44	3000	1000	1056
GOVN*xx	2 to 24	7.8	52	4000	1300	1350

Ordering Information

Fiber Type/Count	2	4	6	8	12	16	24
GOSN							
62.5/125-OM1	GOSN102	GOSN104	GOSN106	GOSN108	GOSN112	GOSN116	GOSN124
50/125-OM2	GOSN202	GOSN204	GOSN206	GOSN208	GOSN212	GOSN216	GOSN224
50/125-OM3	GOSND02	GOSND04	GOSND06	GOSND08	GOSND12	GOSND16	GOSND24
50/125-OM4	GOSNE02	GOSNE04	GOSNE06	GOSNE08	GOSNE12	GOSNE16	GOSNE24
9/125 ITU G.652D	GOSN802	GOSN804	GOSN806	GOSN808	GOSN812	GOSN816	GOSN824
9/125 ITU G.655 C & D	GOSN702	GOSN704	GOSN706	GOSN708	GOSN712	GOSN716	GOSN724
GORN							
62.5/125-OM1	GORN102	GORN104	GORN106	GORN108	GORN112	GORN116	GORN124
50/125-OM2	GORN202	GORN204	GORN206	GORN208	GORN212	GORN216	GORN224
50/125-OM3	GORND02	GORND04	GORND06	GORND08	GORND12	GORND16	GORND24
50/125-OM4	GORNE02	GORNE04	GORNE06	GORNE08	GORNE12	GORNE16	GORNE24
9/125 ITU G.652D	GORN802	GORN804	GORN806	GORN808	GORN812	GORN816	GORN824
9/125 ITU G.655 C & D	GORN702	GORN704	GORN706	GORN708	GORN712	GORN716	GORN724
GOVN							
62.5/125-OM1	GOVN102	GOVN104	GOVN106	GOVN108	GOVN112	GOVN116	GOVN124
50/125-OM2	GOVN202	GOVN204	GOVN206	GOVN208	GOVN212	GOVN216	GOVN224
50/125-OM3	GOVND02	GOVND04	GOVND06	GOVND08	GOVND12	GOVND16	GOVND24
50/125-OM4	GOVNE02	GOVNE04	GOVNE06	GOVNE08	GOVNE12	GOVNE16	GOVNE24
9/125 ITU G.652D	GOVN802	GOVN804	GOVN806	GOVN808	GOVN812	GOVN816	GOVN824
9/125 ITU G.655 C & D	GOVN702	GOVN704	GOVN706	GOVN708	GOVN712	GOVN716	GOVN724
GOSN • GORN • GOVN							
Std. plywood reel (non-returnable)				Ø 800 x 475 mm, Weight 7.65 kg and Ø 1000 x 530 mm, Weight 18.0 kg			
Std. delivery length				2100 ± 100 m and 4100 ± 100 m			

Fiber Color Coding

1 Red	5 Green	9 Orange	13 Red + ring	17 Green + ring	21 Orange + ring
2 Natural	6 Violet	10 Turquoise	14 Natural + ring	18 Violet + ring	22 Turquoise + ring
3 Yellow	7 Brown	11 Pink	15 Yellow + ring	19 Brown + ring	23 Pink + ring
4 Blue	8 Black	12 White	16 Blue + ring	20 Grey + ring	24 White + ring

Outdoor Central Loose Tube Cable with Rodent Protection, Single Jacket

GMSN

A/I-DQ(ZN)B11Y



Applications

- For outdoor and indoor use in structured (data) wiring systems such as campus backbone, building backbone (riser) and/or Horizontal cabling
- Support all computer network applications such as FDDI, Gigabit Ethernet and ATM
- Easy to install in ducts, tunnels and trenches. Not recommended for direct burial

Features & Benefits

- Available in sizes from 2 to 24 fibers
- Jelly filled (non-dripping and silicon-free) loose tube with primary coated optical fibers ($\varnothing 250 \pm 15 \mu\text{m}$)
- Full dielectric construction, no grounding required
- Rodent protected by means of Glass Yarn Strength Elements
- TPU Jacket
- Length marking in meters for easy determination of the cable length

Cross Section

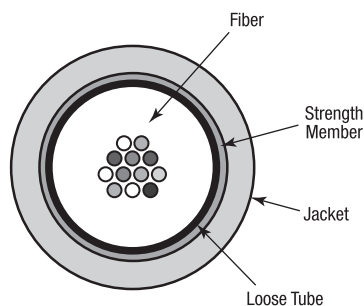

Specifications

IEC 60794-1-2	
Crush Resistance (E3):	15 kN/m
Min. Bend Radius installation (E6):	15 x \varnothing
Min. Bend Radius operation (E11):	10 x \varnothing
Temperature Range (F1):	
– Transport/Storage	-30 °C to +70 °C
– Installation	-5 °C to +50 °C
– Operation	-30 °C to +70 °C
Watertightness (F5):	Pass

Characteristics

Loose Tube	Fiber Count	Diameter (mm)	Weight (kg/km)	Tensile Strength (short term) N	Tensile Strength (permanent) N	Fire Load (kJ/m)
IEC 60794-1-2				E1	E1	
GMSN*xx	2 to 24	6.4	40	1250	420	582

Ordering Information

Fiber Type/Count	2	4	6	8	12	16	24
GMSN							
62.5/125-OM1	GMSN102	GMSN104	GMSN106	GMSN108	GMSN112	GMSN116	GMSN124
50/125-OM2 BI	GMSN202	GMSN204	GMSN206	GMSN208	GMSN212	GMSN216	GMSN224
50/125-OM3 BI	GMSND02	GMSND04	GMSND06	GMSND08	GMSND12	GMSND16	GMSND24
50/125-OM4 BI	GMSNE02	GMSNE04	GMSNE06	GMSNE08	GMSNE12	GMSNE16	GMSNE24
9/125 ITU G.655 C & D	GMSN702	GMSN704	GMSN706	GMSN708	GMSN712	GMSN716	GMSN724
9/125 ITU G.652D & G.657A1	GMSN802	GMSN804	GMSN806	GMSN808	GMSN812	GMSN816	GMSN824
9/125 ITU G.657A2 BI	GMSNF02	GMSNF04	GMSNF06	GMSNF08	GMSNF12	GMSNF16	GMSNF24
9/125 ITU G.657B3 BI	GMSNI02	GMSNI04	GMSNI06	GMSNI08	GMSNI12	GMSNI16	GMSNI24
Std. plywood reel (non-returnable)	Ø 800 x 475 mm, Weight 7.65 kg and Ø 1000 x 530 mm, Weight 18.0 kg						
Std. delivery length	2100m ± 105m						

Fiber Color Coding

No.		No.		No.		No.		No.		No.	
1	Red	5	Green	9	Orange	13	Red + ring	17	Green + ring	21	Orange + ring
2	Natural	6	Violet	10	Turquoise	14	Natural + ring	18	Violet + ring	22	Turquoise + ring
3	Yellow	7	Brown	11	Pink	15	Yellow + ring	19	Brown + ring	23	Pink + ring
4	Blue	8	Black	12	White	16	Blue + ring	20	Grey + ring	24	White + ring

**Universal Central Loose Tube Cable
with Corrugated Steel Tape, Single Jacket**

GUCN, GUCB

A/I-DQ(ZN)(SR)H



Applications

- For outdoor and indoor use in structured (data) wiring systems such as campus backbone
- For outdoor and indoor use in networks for telecom, cable TV and/or broadcast
- Easy to install in ducts, tunnels and trenches by means of compressed air or pulling wire
- Suitable for direct burial

Features & Benefits

- Available in sizes from 4 to 24 fibers
- Jelly filled (non-dripping and silicon-free) loose tube with primary coated optical fibers (Ø 250 ± 15 µm)
- High mechanical and full rodent protection provided by Corrugated Steel Tape (CST) armor
- Halogen Free jacket
- Length marking in meters for easy determination of the cable length

Cross Section

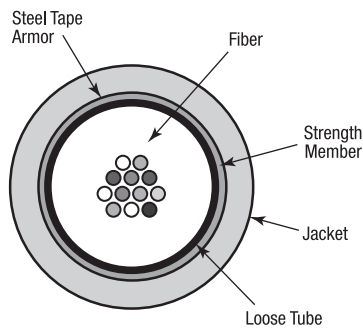

Specifications

IEC 60794-1-2	
Min. Bend Radius installation (E6):	20 x Ø
Min. Bend Radius operation (E11):	20 x Ø
Temperature Range (F1):	
– Transport/Storage	-30 °C to +70 °C
– Installation	-5 °C to +50 °C
– Operation	-30 °C to +70 °C
Watertightness (F5):	Pass
Other	
Circuit Integrity:	EN 50200, IEC 60331-25 (E120)
Flame Retardant:	IEC 60332-3-22
Halogen Free:	IEC 60754-1
Non Corrosive:	IEC 60754-2
Smoke Density:	IEC 61034-2

Characteristics

Loose Tube	Fiber Count	Diameter (mm)	Weight (kg/km)	Crush Resistance (kN/m)	Tensile Strength (short term) N	Tensile Strength (permanent) N	Fire Load (kJ/m)
IEC 60794-1-2					E1	E1	
GUCN*xx	4 to 24	9.0	103	35	1500	500	1045
GUCB*xx	4 to 24	10.6	148	40	2500	830	1308

Ordering Information

Fiber Type/Count	4	6	8	12	16	24
GUCN						
62.5/125-OM1	GUCN104	GUCN106	GUCN108	GUCN112	GUCN116	GUCN124
50/125-OM2	GUCN204	GUCN206	GUCN208	GUCN212	GUCN216	GUCN224
50/125-OM3	GUCND04	GUCND06	GUCND08	GUCND12	GUCND16	GUCND24
50/125-OM4	GUCNE04	GUCNE06	GUCNE08	GUCNE12	GUCNE16	GUCNE24
9/125 ITU G.652D	GUCN804	GUCN806	GUCN808	GUCN812	GUCN816	GUCN824
9/125 ITU G.655 C & D	GUCN704	GUCN706	GUCN708	GUCN712	GUCN716	GUCN724
GUCB						
62.5/125-OM1	GUCB104	GUCB106	GUCB108	GUCB112	GUCB116	GUCB124
50/125-OM2	GUCB204	GUCB206	GUCB208	GUCB212	GUCB216	GUCB224
50/125-OM3	GUCBD04	GUCBD06	GUCBD08	GUCBD12	GUCBD16	GUCBD24
50/125-OM4	GUCBE04	GUCBE06	GUCBE08	GUCBE12	GUCBE16	GUCBE24
9/125 ITU G.652D	GUCB804	GUCB806	GUCB808	GUCB812	GUCB816	GUCB824
9/125 ITU G.655 C & D	GUCB704	GUCB706	GUCB708	GUCB712	GUCB716	GUCB724
GUCN • GUCB						
Std. plywood reel (non-returnable)			Ø 1000 x 530 mm, Weight 18.0 kg			
Std. delivery length			2100 ± 100 m			

Fiber Color Coding

No.		No.		No.		No.		No.		No.	
1	Red	5	Green	9	Orange	13	Red + ring	17	Green + ring	21	Orange + ring
2	Natural	6	Violet	10	Turquoise	14	Natural + ring	18	Violet + ring	22	Turquoise + ring
3	Yellow	7	Brown	11	Pink	15	Yellow + ring	19	Brown + ring	23	Pink + ring
4	Blue	8	Black	12	White	16	Blue + ring	20	Grey + ring	24	White + ring

**Outdoor Central Loose Tube Cable
with Corrugated Steel Tape, Single Jacket**

GOCN, GOCB

A-DQ(ZN)(SR)2Y



Applications

- For outdoor and indoor use in structured (data) wiring systems such as campus backbone
- For outdoor and indoor use in networks for telecom, cable TV and/or broadcast
- Easy to install in ducts, tunnels and trenches by means of compressed air or pulling wire
- Suitable for direct burial

Features & Benefits

- Available in sizes from 4 to 24 fibers
- Jelly filled (non-dripping and silicon-free) loose tube with primary coated optical fibers (Ø 250 ± 15 µm)
- High mechanical and full rodent protection provided by Corrugated Steel Tape (CST) armor
- Polyethylene jacket
- Length marking in meters for easy determination of the cable length

Cross Section

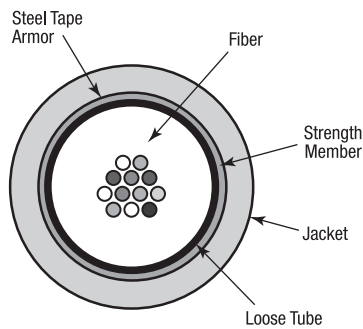

Specifications

IEC 60794-1-2	
Impact Resistance (E4):	3000 N
Min. Bend Radius installation (E6):	20 x Ø
Min. Bend Radius operation (E11):	20 x Ø
Temperature Range (F1):	
– Transport/Storage	-30 °C to +70 °C
– Installation	-5 °C to +50 °C
– Operation	-30 °C to +70 °C
Watertightness (F5):	Pass

Characteristics

Loose Tube	Fiber Count	Diameter (mm)	Weight (kg/km)	Crush Resistance (kN/m)	Tensile Strength (short term) N	Tensile Strength (permanent) N	Fire Load (kJ/m)
IEC 60794-1-2					E1	E1	
GOCN*xx	4 to 24	9.0	80	35	1500	500	1774
GOCB*xx	4 to 24	10.6	107	40	2500	830	2242

Ordering Information

Fiber Type/Count	4	6	8	12	16	24
GOCN						
62.5/125-OM1	GOCN104	GOCN106	GOCN108	GOCN112	GOCN116	GOCN124
50/125-OM2	GOCN204	GOCN206	GOCN208	GOCN212	GOCN216	GOCN224
50/125-OM3	GOCND04	GOCND06	GOCND08	GOCND12	GOCND16	GOCND24
50/125-OM4	GOCNE04	GOCNE06	GOCNE08	GOCNE12	GOCNE16	GOCNE24
9/125 ITU G.652D	GOCN804	GOCN806	GOCN808	GOCN812	GOCN816	GOCN824
9/125 ITU G.655 C & D	GOCN704	GOCN706	GOCN708	GOCN712	GOCN716	GOCN724
GOCB						
62.5/125-OM1	GOCB104	GOCB106	GOCB108	GOCB112	GOCB116	GOCB124
50/125-OM2	GOCB204	GOCB206	GOCB208	GOCB212	GOCB216	GOCB224
50/125-OM3	GOCBD04	GOCBD06	GOCBD08	GOCBD12	GOCBD16	GOCBD24
50/125-OM4	GOCBE04	GOCBE06	GOCBE08	GOCBE12	GOCBE16	GOCBE24
9/125 ITU G.652D	GOCB804	GOCB806	GOCB808	GOCB812	GOCB816	GOCB824
9/125 ITU G.655 C & D	GOCB704	GOCB706	GOCB708	GOCB712	GOCB716	GOCB724
GOCN • GOCB						
Std. plywood reel (non-returnable)			Ø 1250 x 688 mm, Weight 93.0 kg			
Std. delivery length			2100 ± 100 m			

Fiber Color Coding

No.		No.		No.		No.		No.		No.	
1	Red	5	Green	9	Orange	13	Red + ring	17	Green + ring	21	Orange + ring
2	Natural	6	Violet	10	Turquoise	14	Natural + ring	18	Violet + ring	22	Turquoise + ring
3	Yellow	7	Brown	11	Pink	15	Yellow + ring	19	Brown + ring	23	Pink + ring
4	Blue	8	Black	12	White	16	Blue + ring	20	Grey + ring	24	White + ring

**Universal Central Loose Tube Cable
with Corrugated Steel Tape, Double Jacket**

GUDN, GUDB

A/I-DQ(ZN)H(SR)H



Applications

- For outdoor and indoor use in structured (data) wiring systems such as campus backbone
- For outdoor and indoor use in networks for telecom, cable TV and/or broadcast
- Easy to install in ducts, tunnels and trenches by means of compressed air or pulling wire
- Suitable for direct burial

Features & Benefits

- Available in sizes from 4 to 24 fibers
- Jelly filled (non-dripping and silicon-free) loose tube with primary coated optical fibers (Ø 250 ± 15 µm)
- High mechanical and full rodent protection provided by Corrugated Steel Tape (CST) armor
- Halogen Free jacket
- Length marking in meters for easy determination of the cable length

Cross Section

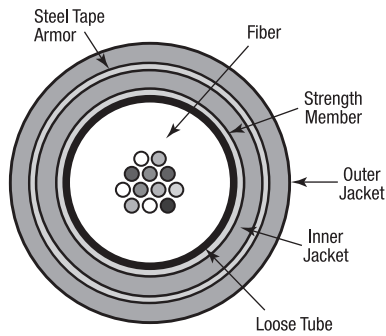

Specifications

IEC 60794-1-2	
Min. Bend Radius installation (E6):	20 x Ø
Min. Bend Radius operation (E11):	20 x Ø
Temperature Range (F1):	
– Transport/Storage	-30 °C to +70 °C
– Installation	-5 °C to +50 °C
– Operation	-30 °C to +70 °C
Watertightness (F5):	Pass
Other	
Flame Retardant:	
– GUDN	IEC 60332-3-22
– GUDB	IEC 60332-3-22
Halogen Free:	IEC 60754-1
Non Corrosive:	IEC 60754-2
Smoke Density:	IEC 61034-2

Characteristics

Loose Tube	Fiber Count	Diameter (mm)	Weight (kg/km)	Crush Resistance (kN/m)	Tensile Strength (short term) N	Tensile Strength (permanent) N	Fire Load (kJ/m)
IEC 60794-1-2					E1	E1	
GUDN*xx	4 to 24	11.0	180	35	1500	500	1550
GUDB*xx	4 to 24	13.0	233	40	2500	830	2919

Ordering Information

Fiber Type/Count	4	6	8	12	16	24
GUDN						
62.5/125-OM1	GUDN104	GUDN106	GUDN108	GUDN112	GUDN116	GUDN124
50/125-OM2	GUDN204	GUDN206	GUDN208	GUDN212	GUDN216	GUDN224
50/125-OM3	GUDND04	GUDND06	GUDND08	GUDND12	GUDND16	GUDND24
50/125-OM4	GUDNE04	GUDNE06	GUDNE08	GUDNE12	GUDNE16	GUDNE24
9/125 ITU G.652D	GUDN804	GUDN806	GUDN808	GUDN812	GUDN816	GUDN824
9/125 ITU G.655 C & D	GUDN704	GUDN706	GUDN708	GUDN712	GUDN716	GUDN724
GUDB						
62.5/125-OM1	GUDB104	GUDB106	GUDB108	GUDB112	GUDB116	GUDB124
50/125-OM2	GUDB204	GUDB206	GUDB208	GUDB212	GUDB216	GUDB224
50/125-OM3	GUDBD04	GUDBD06	GUDBD08	GUDBD12	GUDBD16	GUDBD24
50/125-OM4	GUDBE04	GUDBE06	GUDBE08	GUDBE12	GUDBE16	GUDBE24
9/125 ITU G.652D	GUDB804	GUDB806	GUDB808	GUDB812	GUDB816	GUDB824
9/125 ITU G.655 C & D	GUDB704	GUDB706	GUDB708	GUDB712	GUDB716	GUDB724
GUDN • GUDB						
Std. plywood reel (non-returnable)			Ø 1250 x 688 mm, Weight 93.0 kg			
Std. delivery length			2100 ± 100 m			

Fiber Color Coding

No.		No.		No.		No.		No.		No.	
1	Red	5	Green	9	Orange	13	Red + ring	17	Green + ring	21	Orange + ring
2	Natural	6	Violet	10	Turquoise	14	Natural + ring	18	Violet + ring	22	Turquoise + ring
3	Yellow	7	Brown	11	Pink	15	Yellow + ring	19	Brown + ring	23	Pink + ring
4	Blue	8	Black	12	White	16	Blue + ring	20	Grey + ring	24	White + ring

Outdoor Central Loose Tube Cable with Corrugated Steel Tape, Double Jacket

GODN, GODB

A-DQ(ZN)2Y(SR)2Y



Applications

- For outdoor and indoor use in structured (data) wiring systems such as campus backbone
- For outdoor and indoor use in networks for telecom, cable TV and/or broadcast
- Easy to install in ducts, tunnels and trenches by means of compressed air or pulling wire
- Suitable for direct burial

Features & Benefits

- Available in sizes from 4 to 24 fibers
- Jelly filled (non-dripping and silicon-free) loose tube with primary coated optical fibers ($\varnothing 250 \pm 15 \mu\text{m}$)
- High mechanical and full rodent protection provided by Corrugated Steel Tape (CST) armor
- Polyethylene jacket
- Length marking in meters for easy determination of the cable length

Cross Section

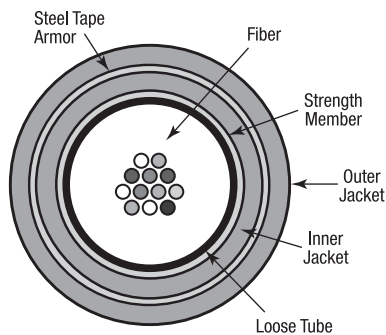

Specifications

IEC 60794-1-2	
Min. Bend Radius installation (E6):	20 x \varnothing
Min. Bend Radius operation (E11):	20 x \varnothing
Temperature Range (F1):	
– Transport/Storage	-30 °C to +70 °C
– Installation	-5 °C to +50 °C
– Operation	-30 °C to +70 °C
Watertightness (F5):	Pass

Characteristics

Loose Tube	Fiber Count	Diameter (mm)	Weight (kg/km)	Crush Resistance (kN/m)	Tensile Strength (short term) N	Tensile Strength (permanent) N	Fire Load (kJ/m)
IEC 60794-1-2					E1	E1	
GODN*xx	4 to 24	11.0	144	35	1500	500	2596
GODB*xx	4 to 24	13.0	178	40	2500	830	4980

Ordering Information

Fiber Type/Count	4	6	8	12	16	24
GODN						
62.5/125-OM1	GODN104	GODN106	GODN108	GODN112	GODN116	GODN124
50/125-OM2	GODN204	GODN206	GODN208	GODN212	GODN216	GODN224
50/125-OM3	GODND04	GODND06	GODND08	GODND12	GODND16	GODND24
50/125-OM4	GODNE04	GODNE06	GODNE08	GODNE12	GODNE16	GODNE24
9/125 ITU G.652D	GODN804	GODN806	GODN808	GODN812	GODN816	GODN824
9/125 ITU G.655 C & D	GODN704	GODN706	GODN708	GODN712	GODN716	GODN724
GODB						
62.5/125-OM1	GODB104	GODB106	GODB108	GODB112	GODB116	GODB124
50/125-OM2	GODB204	GODB206	GODB208	GODB212	GODB216	GODB224
50/125-OM3	GOSBD04	GOSBD06	GOSBD08	GOSBD12	GOSBD16	GOSBD24
50/125-OM4	GOSBE04	GOSBE06	GOSBE08	GOSBE12	GOSBE16	GOSBE24
9/125 ITU G.652D	GOSB804	GOSB806	GOSB808	GOSB812	GOSB816	GOSB824
9/125 ITU G.655 C & D	GOSB704	GOSB706	GOSB708	GOSB712	GOSB716	GOSB724
GODN • GODB						
Std. plywood reel (non-returnable)			Ø 1250 x 688 mm, Weight 93.0 kg			
Std. delivery length			2100 ± 100 m			

Fiber Color Coding

No.		No.		No.		No.		No.		No.	
1	Red	5	Green	9	Orange	13	Red + ring	17	Green + ring	21	Orange + ring
2	Natural	6	Violet	10	Turquoise	14	Natural + ring	18	Violet + ring	22	Turquoise + ring
3	Yellow	7	Brown	11	Pink	15	Yellow + ring	19	Brown + ring	23	Pink + ring
4	Blue	8	Black	12	White	16	Blue + ring	20	Grey + ring	24	White + ring

**Universal Central Loose Tube Cable
with Steel Wire Braid, Double Jacket**

GUHA

A/I-DQ(ZN)H(SR)H



Applications

- For outdoor and indoor use in structured (data) wiring systems such as campus backbone
- For outdoor and indoor use in networks for telecom, cable TV and/or broadcast
- Easy to install in ducts, tunnels and trenches by means of compressed air or pulling wire
- Suitable for direct burial

Features & Benefits

- Available in sizes from 4 to 24 fibers
- Jelly filled (non-dripping and silicon-free) loose tube with primary coated optical fibers (Ø 250 ± 15 µm)
- High mechanical and full rodent protection provided by Steel Wire Braid (SWB) armor
- Halogen Free jacket
- Length marking in meters for easy determination of the cable length

Cross Section

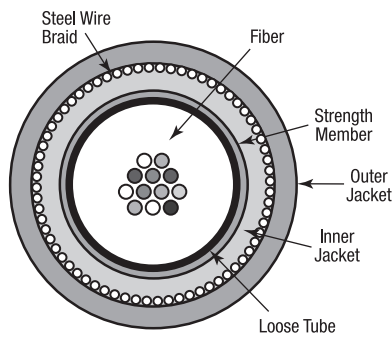

Specifications

IEC 60794-1-2	
Min. Bend Radius installation (E6):	20 x Ø
Min. Bend Radius operation (E11):	20 x Ø
Temperature Range (F1):	
– Transport/Storage	-30 °C to +70 °C
– Installation	-5 °C to +50 °C
– Operation	-30 °C to +70 °C
Watertightness (F5):	Pass
Other	
Flame Retardant:	IEC 60332-3-25
Halogen Free:	IEC 60754-1
Non Corrosive:	IEC 60754-2
Smoke Density:	IEC 61034-2

Characteristics

Loose Tube	Fiber Count	Diameter (mm)	Weight (kg/km)	Crush Resistance (kN/m)	Tensile Strength (short term) N	Tensile Strength (permanent) N	Fire Load (kJ/m)
IEC 60794-1-2					E1	E1	
GUHA*xx	4 to 24	10.0	127	25	1250	420	1509

Ordering Information

Fiber Type/Count	4	6	8	12	16	24
62.5/125-OM1	GUHA104	GUHA106	GUHA108	GUHA112	GUHA116	GUHA124
50/125-OM2	GUHA204	GUHA206	GUHA208	GUHA212	GUHA216	GUHA224
50/125-OM3	GUHAD04	GUHAD06	GUHAD08	GUHAD12	GUHAD16	GUHAD24
50/125-OM4	GUHAE04	GUHAE06	GUHAE08	GUHAE12	GUHAE16	GUHAE24
9/125 ITU G.652D	GUHA804	GUHA806	GUHA808	GUHA812	GUHA816	GUHA824
9/125 ITU G.655 C & D	GUHA704	GUHA706	GUHA708	GUHA712	GUHA716	GUHA724
Std. plywood reel (non-returnable)	Ø 1000 x 588 mm, Weight 50.0 kg					
Std. delivery length	2100 ± 100 m					

Fiber Color Coding

No.		No.		No.		No.		No.		No.	
1	Red	5	Green	9	Orange	13	Red + ring	17	Green + ring	21	Orange + ring
2	Natural	6	Violet	10	Turquoise	14	Natural + ring	18	Violet + ring	22	Turquoise + ring
3	Yellow	7	Brown	11	Pink	15	Yellow + ring	19	Brown + ring	23	Pink + ring
4	Blue	8	Black	12	White	16	Blue + ring	20	Grey + ring	24	White + ring

Outdoor Central Loose Tube Cable with Steel Wire Braid, Double Jacket

GOHN

A-DQ(ZN)2Y(SR)2Y



Applications

- For outdoor and indoor use in structured (data) wiring systems such as campus backbone
- For outdoor and indoor use in networks for telecom, cable TV and/or broadcast
- Easy to install in ducts, tunnels and trenches by means of compressed air or pulling wire
- Suitable for direct burial

Features & Benefits

- Available in sizes from 4 to 24 fibers
- Jelly filled (non-dripping and silicon-free) loose tube with primary coated optical fibers ($\varnothing 250 \pm 15 \mu\text{m}$)
- High mechanical and full rodent protection provided by Steel Wire Braid (SWB) armor
- Polyethylene jacket
- Length marking in meters for easy determination of the cable length

Cross Section

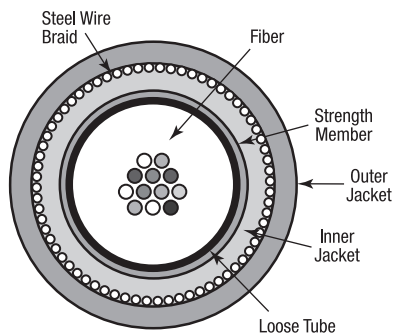

Specifications

IEC 60794-1-2

Min. Bend Radius installation (E6):	20 x \varnothing
Min. Bend Radius operation (E11):	10 x \varnothing
Temperature Range (F1):	
– Transport/Storage	-30 °C to +70 °C
– Installation	-5 °C to +50 °C
– Operation	-30 °C to +70 °C
Watertightness (F5):	Pass

Characteristics

Loose Tube	Fiber Count	Diameter (mm)	Weight (kg/km)	Crush Resistance (kN/m)	Tensile Strength (short term) N	Tensile Strength (permanent) N	Fire Load (kJ/m)
IEC 60794-1-2					E1	E1	
GOHN*xx	4 to 24	10.0	98	25	1250	420	2503

Ordering Information

Fiber Type/Count	4	6	8	12	16	24
62.5/125-OM1	GOHN104	GOHN106	GOHN108	GOHN112	GOHN116	GOHN124
50/125-OM2	GOHN204	GOHN206	GOHN208	GOHN212	GOHN216	GOHN224
50/125-OM3	GOHND04	GOHND06	GOHND08	GOHND12	GOHND16	GOHND24
50/125-OM4	GOHNE04	GOHNE06	GOHNE08	GOHNE12	GOHNE16	GOHNE24
9/125 ITU G.652D	GOHN804	GOHN806	GOHN808	GOHN812	GOHN816	GOHN824
9/125 ITU G.655 C & D	GOHN704	GOHN706	GOHN708	GOHN712	GOHN716	GOHN724
Std. plywood reel (non-returnable)	Ø 1000 x 588 mm, Weight 50.0 kg					
Std. delivery length	2100 ± 100 m					

Fiber Color Coding

No.		No.		No.		No.		No.		No.	
1	Red	5	Green	9	Orange	13	Red + ring	17	Green + ring	21	Orange + ring
2	Natural	6	Violet	10	Turquoise	14	Natural + ring	18	Violet + ring	22	Turquoise + ring
3	Yellow	7	Brown	11	Pink	15	Yellow + ring	19	Brown + ring	23	Pink + ring
4	Blue	8	Black	12	White	16	Blue + ring	20	Grey + ring	24	White + ring

Universal Central Loose Tube Cable with Steel Wire Armor, Double Jacket

GUWN, GUWB

A/I-DQ(ZN)H(SR)H



Applications

- For outdoor and indoor use in structured (data) wiring systems such as industrial backbone, campus backbone, building backbone (riser) and/or horizontal cabling
- For outdoor and indoor use in networks for industrial, telecom, cable TV and/or broadcast
- Easy to install in ducts, tunnels and trenches by means of compressed air or pulling wire
- Suitable for direct burial

Features & Benefits

- Available in sizes from 4 to 24 fibers
- Jelly filled (non-dripping and silicon-free) loose tube with primary coated optical fibers ($\varnothing 250 \pm 15 \mu\text{m}$)
- High mechanical and full rodent protection provided by Steel Wire Armor (SWA)
- Halogen Free jacket
- Length marking in meters for easy determination of the cable length

Cross Section

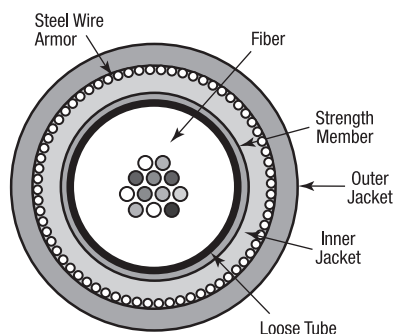

Specifications

IEC 60794-1-2	
Min. Bend Radius installation (E6):	20 x \varnothing
Min. Bend Radius operation (E11):	20 x \varnothing
Temperature Range (F1):	
– Transport/Storage	-30 °C to +70 °C
– Installation	-5 °C to +50 °C
– Operation	-30 °C to +70 °C
Watertightness (F5):	Pass
Other	
Flame Retardant:	
– GUWN	IEC 60332-3-25
– GUWB	IEC 60332-3-24
Halogen Free:	IEC 60754-1
Non Corrosive:	IEC 60754-2
Smoke Density:	IEC 61034-2

Characteristics

Loose Tube	Fiber Count	Diameter (mm)	Steel Wire Diameter (mm)	Weight (kg/km)	Crush Resistance (kN/m)	Tensile Strength (short term) N	Tensile Strength (permanent) N	Fire Load (kJ/m)
IEC 60794-1-2						E1	E1	
GUWN*xx	4 to 24	9.6	0.6	155	45	1250	420	1500
GUWB*xx	4 to 24	13.8	0.9	325	50	3750	1250	2625

Ordering Information

Fiber Type/Count	4	6	8	12	16	24
GUWN						
62.5/125-OM1	GUWN104	GUWN106	GUWN108	GUWN112	GUWN116	GUWN124
50/125-OM2	GUWN204	GUWN206	GUWN208	GUWN212	GUWN216	GUWN224
50/125-OM3	GUWND04	GUWND06	GUWND08	GUWND12	GUWND16	GUWND24
50/125-OM4	GUWNE04	GUWNE06	GUWNE08	GUWNE12	GUWNE16	GUWNE24
9/125 ITU G.652D	GUWN804	GUWN806	GUWN808	GUWN812	GUWN816	GUWN824
9/125 ITU G.655 C & D	GUWN704	GUWN706	GUWN708	GUWN712	GUWN716	GUWN724
Std. plywood reel (non-returnable)	Ø 1000 x 588 mm, Weight 50.0 kg					
Std. delivery length	2100 ± 100 m					
GUWB						
62.5/125-OM1	GUWB104	GUWB106	GUWB108	GUWB112	GUWB116	GUWB124
50/125-OM2	GUWB204	GUWB206	GUWB208	GUWB212	GUWB216	GUWB224
50/125-OM3	GUWBD04	GUWBD06	GUWBD08	GUWBD12	GUWBD16	GUWBD24
50/125-OM4	GUWBE04	GUWBE06	GUWBE08	GUWBE12	GUWBE16	GUWBE24
9/125 ITU G.652D	GUWB804	GUWB806	GUWB808	GUWB812	GUWB816	GUWB824
9/125 ITU G.655 C & D	GUWB704	GUWB706	GUWB708	GUWB712	GUWB716	GUWB724
Std. plywood reel (non-returnable)	Ø 1250 x 688 mm, Weight 93.0 kg					
Std. delivery length	2100 ± 100 m					

Fiber Color Coding

No.		No.		No.		No.		No.		No.	
1	Red	5	Green	9	Orange	13	Red + ring	17	Green + ring	21	Orange + ring
2	Natural	6	Violet	10	Turquoise	14	Natural + ring	18	Violet + ring	22	Turquoise + ring
3	Yellow	7	Brown	11	Pink	15	Yellow + ring	19	Brown + ring	23	Pink + ring
4	Blue	8	Black	12	White	16	Blue + ring	20	Grey + ring	24	White + ring

Outdoor Central Loose Tube Cable with Steel Wire Armor, Double Jacket

GOWN, GOWB

A-DQ(ZN)2Y(SR)2Y

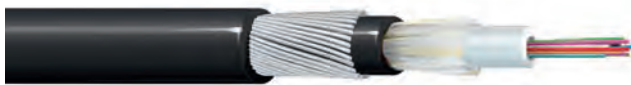

Applications

- For outdoor and indoor use in structured (data) wiring systems such as industrial backbone, campus backbone, building backbone (riser) and/or horizontal cabling
- For outdoor and indoor use in networks for industrial, telecom, cable TV and/or broadcast
- Easy to install in ducts, tunnels and trenches by means of compressed air or pulling wire
- Suitable for direct burial

Features & Benefits

- Available in sizes from 4 to 24 fibers
- Jelly filled (non-dripping and silicon-free) loose tube with primary coated optical fibers ($\text{Ø } 250 \pm 15 \mu\text{m}$)
- High mechanical and full rodent protection provided by Steel Wire Armor (SWA)
- Polyethylene jacket
- Length marking in meters for easy determination of the cable length

Cross Section

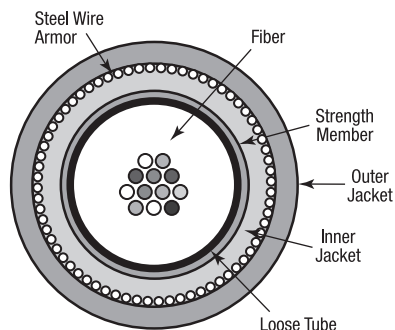

Specifications

IEC 60794-1-2

Min. Bend Radius installation (E6):	20 x Ø
Min. Bend Radius operation (E11):	10 x Ø
Temperature Range (F1):	
– Transport/Storage	-30 °C to +70 °C
– Installation	-5 °C to +50 °C
– Operation	-30 °C to +70 °C
Watertightness (F5):	Pass

Characteristics

Loose Tube	Fiber Count	Diameter (mm)	Steel Wire Diameter (mm)	Weight (kg/km)	Crush Resistance (kN/m)	Tensile Strength (short term) N	Tensile Strength (permanent) N	Fire Load (kJ/m)
IEC 60794-1-2						E1	E1	
GOWN*xx	4 to 24	9.6	0.6	125	45	1250	420	2505
GOWB*xx	4 to 24	13.5	0.9	270	50	3750	1250	2625

Ordering Information

Fiber Type/Count	4	6	8	12	16	24
GOWN						
62.5/125-OM1	GOWN104	GOWN106	GOWN108	GOWN112	GOWN116	GOWN124
50/125-OM2	GOWN204	GOWN206	GOWN208	GOWN212	GOWN216	GOWN224
50/125-OM3	GOWND04	GOWND06	GOWND08	GOWND12	GOWND16	GOWND24
50/125-OM4	GOWNE04	GOWNE06	GOWNE08	GOWNE12	GOWNE16	GOWNE24
9/125 ITU G.652D	GOWN804	GOWN806	GOWN808	GOWN812	GOWN816	GOWN824
9/125 ITU G.655 C & D	GOWN704	GOWN706	GOWN708	GOWN712	GOWN716	GOWN724
Std. plywood reel (non-returnable)	Ø 1000 x 588 mm, Weight 50.0 kg					
Std. delivery length	2100 ± 100 m					
GOWB						
62.5/125-OM1	GOWB104	GOWB106	GOWB108	GOWB112	GOWB116	GOWB124
50/125-OM2	GOWB204	GOWB206	GOWB208	GOWB212	GOWB216	GOWB224
50/125-OM3	GOWBD04	GOWBD06	GOWBD08	GOWBD12	GOWBD16	GOWBD24
50/125-OM4	GOWBE04	GOWBE06	GOWBE08	GOWBE12	GOWBE16	GOWBE24
9/125 ITU G.652D	GOWB804	GOWB806	GOWB808	GOWB812	GOWB816	GOWB824
9/125 ITU G.655 C & D	GOWB704	GOWB706	GOWB708	GOWB712	GOWB716	GOWB724
Std. plywood reel (non-returnable)	Ø 1250 x 688 mm, Weight 93.0 kg					
Std. delivery length	2100 ± 100 m					

Fiber Color Coding

No.		No.		No.		No.		No.		No.	
1	Red	5	Green	9	Orange	13	Red + ring	17	Green + ring	21	Orange + ring
2	Natural	6	Violet	10	Turquoise	14	Natural + ring	18	Violet + ring	22	Turquoise + ring
3	Yellow	7	Brown	11	Pink	15	Yellow + ring	19	Brown + ring	23	Pink + ring
4	Blue	8	Black	12	White	16	Blue + ring	20	Grey + ring	24	White + ring

Universal Central Loose Tube Cable with Fiber Reinforced Plastic Armor, Single Jacket

GUFN, GUFB

A/I-DQBH



Applications

- For outdoor and indoor use in structured (data) wiring systems such as industrial backbone, campus backbone, building backbone (riser) and/or horizontal cabling
- For outdoor and indoor use in networks for industrial, telecom, cable TV and/or broadcast
- Easy to install in ducts, tunnels and trenches by means of compressed air or pulling wire
- Suitable for direct burial

Features & Benefits

- Available in sizes from 4 to 24 fibers
- Jelly filled (non-dripping and silicon-free) loose tube with primary coated optical fibers ($\text{Ø } 250 \pm 15 \mu\text{m}$)
- High mechanical and full rodent protection provided by Fiber Reinforced Plastic (FRP) armor
- These cables are all dielectric and therefore immune to lightning and electromagnetic interference (EMC-safe), spark-free and require no grounding
- Halogen Free jacket
- Length marking in meters for easy determination of the cable length

Cross Section

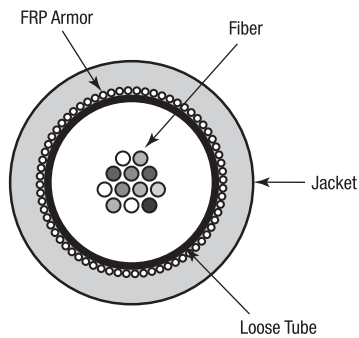

Specifications

IEC 60794-1-2

Min. Bend Radius installation (E6):	20 x Ø
Min. Bend Radius operation (E11):	20 x Ø
Temperature Range (F1):	
– Transport/Storage	-30 °C to +70 °C
– Installation	-5 °C to +50 °C
– Operation	-30 °C to +70 °C

Watertightness (F5): Pass

Other

Flame Retardant:	
– GUFN	IEC 60332-1
– GUFB	IEC 60332-3-24
Halogen Free:	IEC 60754-1
Non Corrosive:	IEC 60754-2
Smoke Density:	IEC 61034-2

Characteristics

Loose Tube	Fiber Count	Diameter (mm)	FRP Diameter (mm)	Weight (kg/km)	Crush Resistance (kN/m)	Tensile Strength (short term) N	Tensile Strength (permanent) N	Fire Load (kJ/m)
IEC 60794-1-2						E1	E1	
GUFN*xx	4 to 24	7.4	1.0	62	45	3250	1100	1030
GUFB*xx	4 to 24	9.0	1.0	110	50	4000	1300	1370

Ordering Information

Fiber Type/Count	4	6	8	12	16	24
GUFN						
62.5/125-OM1	GUFN104	GUFN106	GUFN108	GUFN112	GUFN116	GUFN124
50/125-OM2	GUFN204	GUFN206	GUFN208	GUFN212	GUFN216	GUFN224
50/125-OM3	GUFND04	GUFND06	GUFND08	GUFND12	GUFND16	GUFND24
50/125-OM4	GUFNE04	GUFNE06	GUFNE08	GUFNE12	GUFNE16	GUFNE24
9/125 ITU G.652D	GUFN804	GUFN806	GUFN808	GUFN812	GUFN816	GUFN824
9/125 ITU G.655 C & D	GUFN704	GUFN706	GUFN708	GUFN712	GUFN716	GUFN724
Std. plywood reel (non-returnable)	Ø 1000 x 588 mm, Weight 50.0 kg					
Std. delivery length	2100 ± 100 m					
GUFB						
62.5/125-OM1	GUFB104	GUFB106	GUFB108	GUFB112	GUFB116	GUFB124
50/125-OM2	GUFB204	GUFB206	GUFB208	GUFB212	GUFB216	GUFB224
50/125-OM3	GUFBD04	GUFBD06	GUFBD08	GUFBD12	GUFBD16	GUFBD24
50/125-OM4	GUFBE04	GUFBE06	GUFBE08	GUFBE12	GUFBE16	GUFBE24
9/125 ITU G.652D	GUFB804	GUFB806	GUFB808	GUFB812	GUFB816	GUFB824
9/125 ITU G.655 C & D	GUFB704	GUFB706	GUFB708	GUFB712	GUFB716	GUFB724
Std. plywood reel (non-returnable)	Ø 1250 x 688 mm, Weight 93.0 kg					
Std. delivery length	2100 ± 100 m					

Fiber Color Coding

No.		No.		No.		No.		No.		No.	
1	Red	5	Green	9	Orange	13	Red + ring	17	Green + ring	21	Orange + ring
2	Natural	6	Violet	10	Turquoise	14	Natural + ring	18	Violet + ring	22	Turquoise + ring
3	Yellow	7	Brown	11	Pink	15	Yellow + ring	19	Brown + ring	23	Pink + ring
4	Blue	8	Black	12	White	16	Blue + ring	20	Grey + ring	24	White + ring

Outdoor Central Loose Tube Cable with Fiber Reinforced Plastic Armor, Single Jacket

GOFN, GOFB

A-DQB2Y



Applications

- For outdoor and indoor use in structured (data) wiring systems such as industrial backbone, campus backbone, building backbone (riser) and/or horizontal cabling
- For outdoor and indoor use in networks for industrial, telecom, cable TV and/or broadcast
- Easy to install in ducts, tunnels and trenches by means of compressed air or pulling wire
- Suitable for direct burial

Features & Benefits

- Available in sizes from 4 to 24 fibers
- Jelly filled (non-dripping and silicon-free) loose tube with primary coated optical fibers ($\text{Ø } 250 \pm 15 \mu\text{m}$)
- High mechanical and full rodent protection provided by Fiber Reinforced Plastic (FRP) armor
- Polyethylene jacket
- Length marking in meters for easy determination of the cable length

Cross Section

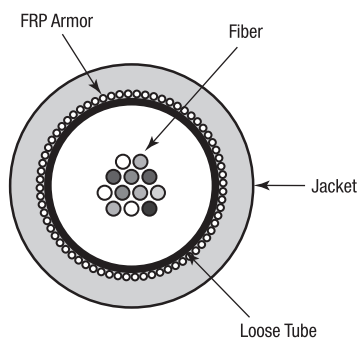

Specifications

IEC 60794-1-2	
Min. Bend Radius installation (E6):	20 x Ø
Min. Bend Radius operation (E11):	20 x Ø
Temperature Range (F1):	
– Transport/Storage	-30 °C to +70 °C
– Installation	-5 °C to +50 °C
– Operation	-30 °C to +70 °C
Watertightness (F5):	Pass

Characteristics

Loose Tube	Fiber Count	Diameter (mm)	FRP Diameter (mm)	Weight (kg/km)	Crush Resistance (kN/m)	Tensile Strength (short term) N	Tensile Strength (permanent) N	Fire Load (kJ/m)
IEC 60794-1-2						E1	E1	
GOFN*xx	4 to 24	7.4	1.0	51	45	3250	1100	1430
GOFB*xx	4 to 24	9.0	1.0	76	50	4000	1300	2410

Ordering Information

Fiber Type/Count	4	6	8	12	16	24
GOFN						
62.5/125-OM1	GOFN104	GOFN106	GOFN108	GOFN112	GOFN116	GOFN124
50/125-OM2	GOFN204	GOFN206	GOFN208	GOFN212	GOFN216	GOFN224
50/125-OM3	GOFND04	GOFND06	GOFND08	GOFND12	GOFND16	GOFND24
50/125-OM4	GOFNE04	GOFNE06	GOFNE08	GOFNE12	GOFNE16	GOFNE24
9/125 ITU G.652D	GOFN804	GOFN806	GOFN808	GOFN812	GOFN816	GOFN824
9/125 ITU G.655 C & D	GOFN704	GOFN706	GOFN708	GOFN712	GOFN716	GOFN724
Std. plywood reel (non-returnable)	Ø 1000 x 588 mm, Weight 50.0 kg					
Std. delivery length	2100 ± 100 m					
GOFB						
62.5/125-OM1	GOFB104	GOFB106	GOFB108	GOFB112	GOFB116	GOFB124
50/125-OM2	GOFB204	GOFB206	GOFB208	GOFB212	GOFB216	GOFB224
50/125-OM3	GOFBD04	GOFBD06	GOFBD08	GOFBD12	GOFBD16	GOFBD24
50/125-OM4	GOFBE04	GOFBE06	GOFBE08	GOFBE12	GOFBE16	GOFBE24
9/125 ITU G.652D	GOFB804	GOFB806	GOFB808	GOFB812	GOFB816	GOFB824
9/125 ITU G.655 C & D	GOFB704	GOFB706	GOFB708	GOFB712	GOFB716	GOFB724
Std. plywood reel (non-returnable)	Ø 1250 x 688 mm, Weight 93.0 kg					
Std. delivery length	2100 ± 100 m					

Fiber Color Coding

1 Red	5 Green	9 Orange	13 Red + ring	17 Green + ring	21 Orange + ring
2 Natural	6 Violet	10 Turquoise	14 Natural + ring	18 Violet + ring	22 Turquoise + ring
3 Yellow	7 Brown	11 Pink	15 Yellow + ring	19 Brown + ring	23 Pink + ring
4 Blue	8 Black	12 White	16 Blue + ring	20 Grey + ring	24 White + ring

Universal Multi Loose Tube Cable with Rodent Protection, Single Jacket

GCRG, GCRD, GCRE, GCRF

A/I-DQ(ZN)BH



Applications

- For outdoor and indoor use in structured (data) wiring systems such as campus backbone
- For outdoor and indoor use in networks for telecom, cable TV and/or broadcast
- Easy to install in ducts, tunnels and trenches by means of compressed air or pulling wire
- Suitable for direct burial

Features & Benefits

- Available in sizes from 2 to 144 fibers
- Jelly filled (non-dripping and silicon-free) loose tubes with primary coated optical fibers ($\varnothing 250 \pm 15 \mu\text{m}$)
- Full dielectric construction, no grounding required
- Installation-friendly thanks to the cable core which is kept free of grease (dry interstices)
- Rodent protected by means of Glass Yarn Strength Elements
- Halogen Free jacket
- Length marking in meters for easy determination of the cable length

Cross Section

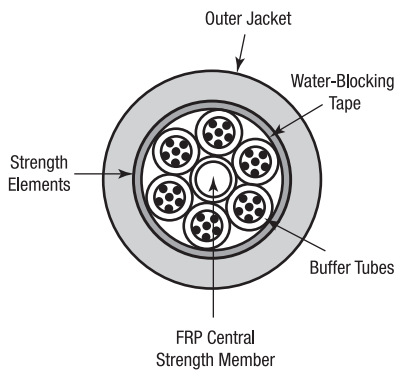

Specifications

IEC 60794-1-2

Crush Resistance (E3):	15 kN/m
Min. Bend Radius installation (E6):	20 x \varnothing
Min. Bend Radius operation (E11):	20 x \varnothing
Temperature Range (F1):	
- Transport/Storage	-30 °C to +70 °C
- Installation	-5 °C to +50 °C
- Operation	-30 °C to +70 °C
Watertightness (F5):	Pass

Other

Flame Retardant:	IEC 60332-3-24
Halogen Free:	IEC 60754-1
Non Corrosive:	IEC 60754-2
Smoke Density:	IEC 61034-2

Characteristics

Loose Tube	Fiber Count	Diameter Tube (mm)	Max. Fibers per Tube	Watertightness in Core	Diameter (mm)	Weight (kg/km)	Tensile Strength (short term) N	Tensile Strength (permanent) N	Fire Load (kJ/m)
IEC 60794-1-2							E1	E1	
GCRG*xx	6 to 36	1.9	6	Dry	11.8	159	6000	2000	2500
GCRD*xx	12 to 72	2.5	12	Dry	13.7	169	6600	2200	3000
GCRE*xx	84 to 96	2.5	12	Dry	15.3	215	8000	2650	3200
GCRF*xx	108 to 144	2.5	12	Dry	18.5	276	8000	3200	5900

Ordering Information

Fiber Type/Count	Dry Core				
	6	12	18	24	36
62.5/125-OM1	GCRG106	GCRG112	GCRG118	GCRG124	GCRG136
50/125-OM2	GCRG206	GCRG212	GCRG218	GCRG224	GCRG236
50/125-OM3	GCRGD06	GCRGD12	GCRGD18	GCRGD24	GCRGD36
50/125-OM4	GCRGE06	GCRGE12	GCRGE18	GCRGE24	GCRGE36
9/125 ITU G.652D	GCRG806	GCRG812	GCRG818	GCRG824	GCRG836
9/125 ITU G.655 C & D	GCRG706	GCRG712	GCRG718	GCRG724	GCRG736
Std. plywood reel (non-returnable)	Ø 1250 x 688 mm, Weight 93.0 kg				
Std. delivery length	2100 ± 100 m				

Fiber Type/Count	Dry Core					
	12	24	36	48	60	72
62.5/125-OM1	GCRD112	GCRD124	GCRD136	GCRD148	GCRD160	GCRD172
50/125-OM2	GCRD212	GCRD224	GCRD236	GCRD248	GCRD260	GCRD272
50/125-OM3	GCRDD12	GCRDD24	GCRDD36	GCRDD48	GCRDD60	GCRDD72
50/125-OM4	GCRDE12	GCRDE24	GCRDE36	GCRDE48	GCRDE60	GCRDE72
9/125 ITU G.652D	GCRD812	GCRD824	GCRD836	GCRD848	GCRD860	GCRD872
9/125 ITU G.655 C & D	GCRD712	GCRD724	GCRD736	GCRD748	GCRD760	GCRD772
Std. plywood reel (non-returnable)	Ø 1250 x 688 mm, Weight 93.0 kg					
Std. delivery length	2100 ± 100 m					

Ordering Information

Fiber Type/Count	Dry Core	
	96	144
62.5/125-OM1	GCRE196	GCRE144
50/125-OM2	GCRE296	GCRE244
50/125-OM3	GCRE96	GCRFD44
50/125-OM4	GCREE96	GCRFE44
9/125 ITU G.652D	GCRE896	GCRF844
9/125 ITU G.655 C & D	GCRE796	GCRF744
Std. plywood reel (non-returnable)	Ø 1400 x 900 mm, Weight 120.0 kg	
Std. delivery length	2100 ± 100 m	

Fiber Color Coding

No.		No.		No.	
1	Red	11	White	21	Grey + ring
2	Green	12	Aqua	22	Brown + ring
3	Blue	13	Red + ring	23	White + ring
4	Yellow	14	Green + ring	24	Aqua + ring
5	Violet	15	Blue + ring		
6	Pink	16	Yellow + ring		
7	Orange	17	Violet + ring		
8	Black	18	Pink + ring		
9	Grey	19	Orange + ring		
10	Brown	20	Black + ring		

Tube Color Coding

No.	
1	Red
2	Green
3 to 12	White

Outdoor Multi Loose Tube Cable with Rodent Protection, Single Jacket

GBRG, GBRD, GBRE, GBRF
GDRG, GDRD, GDRE, GDRF

A-DQ(ZN)B2Y
A-DF(ZN)B2Y

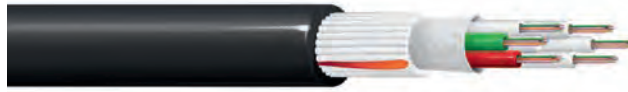

Applications

- For outdoor and indoor use in structured (data) wiring systems such as campus backbone
- For outdoor and indoor use in networks for telecom, cable TV and/or broadcast
- Easy to install in ducts, tunnels and trenches by means of compressed air or pulling wire
- Suitable for direct burial

Features & Benefits

- Available in sizes from 2 to 144 fibers
- Jelly filled (non-dripping and silicon-free) loose tubes with primary coated optical fibers ($\varnothing 250 \pm 15 \mu\text{m}$)
- Full dielectric construction, no grounding required
- Installation-friendly thanks to the cable core which is kept free of grease (dry interstices) for GBR types
- Rodent protected by means of Glass Yarn Strength Elements
- Polyethylene jacket
- Length marking in meters for easy determination of the cable length

Specifications

IEC 60794-1-2	
Crush Resistance (E3):	15 kN/m
Min. Bend Radius installation (E6):	20 x \varnothing
Min. Bend Radius operation (E11):	20 x \varnothing
Temperature Range (F1):	
- Transport/Storage	-30 °C to +70 °C
- Installation	-5 °C to +50 °C
- Operation	-30 °C to +70 °C
Watertightness (F5):	Pass

Cross Section

GBR

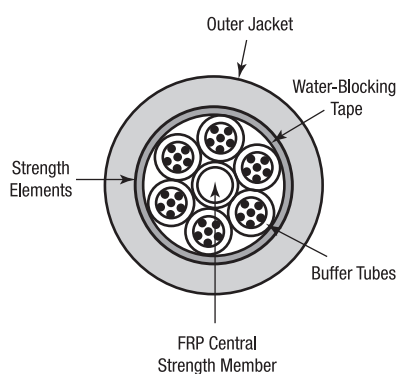

GDR

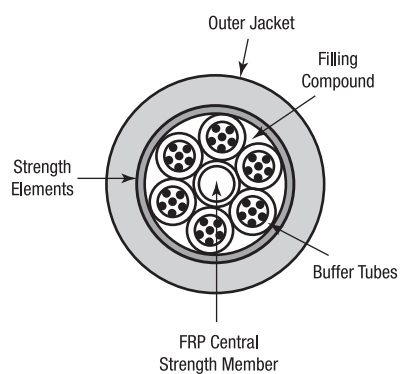

Characteristics

Loose Tube	Fiber Count	Diameter Tube (mm)	Max. Fibers per Tube	Watertightness in Core	Diameter (mm)	Weight (kg/km)	Tensile Strength (short term) N	Tensile Strength (permanent) N	Fire Load (kJ/m)
IEC 60794-1-2							E1	E1	
GBRG*xx	6 to 36	1.9	6	Dry	11.8	105	6000	2000	3200
GDRG*xx	6 to 36	1.9	6	Filled	11.8	107	6000	2000	3600
GBRD*xx	12 to 72	2.5	12	Dry	13.7	145	6600	2200	4600
GDRD*xx	12 to 72	2.5	12	Filled	13.7	147	6600	2200	5000
GBRE*xx	84 to 96	2.5	12	Dry	15.3	170	8000	2650	4900
GDRE*xx	84 to 96	2.5	12	Filled	15.3	174	8000	2650	5500
GBRF*xx	108 to 144	2.5	12	Dry	18.5	248	8000	3200	7700
GDRF*xx	108 to 144	2.5	12	Filled	18.5	254	8000	2670	8600

Ordering Information

Fiber Type/Count	Dry Core					Filled Core				
	6	12	18	24	36	6	12	18	24	36
62.5/125-OM1	GBRG106	GBRG112	GBRG118	GBRG124	GBRG136	GDRG106	GDRG112	GDRG118	GDRG124	GDRG136
50/125-OM2	GBRG206	GBRG212	GBRG218	GBRG224	GBRG236	GDRG206	GDRG212	GDRG218	GDRG224	GDRG236
50/125-OM3	GBRGD06	GBRGD12	GBRGD18	GBRGD24	GBRGD36	GDRGD06	GDRGD12	GDRGD18	GDRGD24	GDRGD36
50/125-OM4	GBRGE06	GBRGE12	GBRGE18	GBRGE24	GBRGE36	GDRGE06	GDRGE12	GDRGE18	GDRGE24	GDRGE36
9/125 ITU G.652D	GBRG806	GBRG812	GBRG818	GBRG824	GBRG836	GDRG806	GDRG812	GDRG818	GDRG824	GDRG836
9/125 ITU G.655 C & D	GBRG706	GBRG712	GBRG718	GBRG724	GBRG736	GDRG706	GDRG712	GDRG718	GDRG724	GDRG736
Std. plywood reel (non-returnable)	Ø 1250 x 688 mm, Weight 93.0 kg					Ø 1250 x 688 mm, Weight 93.0 kg				
Std. delivery length	2100 ± 100 m					2100 ± 100 m				

Fiber Type/Count	Dry Core						Filled Core					
	12	24	36	48	60	72	12	24	36	48	60	72
62.5/125-OM1	GBRD112	GBRD124	GBRD136	GBRD148	GBRD160	GBRD172	GDRD112	GDRD124	GDRD136	GDRD148	GDRD160	GDRD172
50/125-OM2	GBRD212	GBRD224	GBRD236	GBRD248	GBRD260	GBRD272	GDRD212	GDRD224	GDRD236	GDRD248	GDRD260	GDRD272
50/125-OM3	GBRDD12	GBRDD24	GBRDD36	GBRDD48	GBRDD60	GBRDD72	GDRDD12	GDRDD24	GDRDD36	GDRDD48	GDRDD60	GDRDD72
50/125-OM4	GBRDE12	GBRDE24	GBRDE36	GBRDE48	GBRDE60	GBRDE72	GDRDE12	GDRDE24	GDRDE36	GDRDE48	GDRDE60	GDRDE72
9/125 ITU G.652D	GBRD812	GBRD824	GBRD836	GBRD848	GBRD860	GBRD872	GDRD812	GDRD824	GDRD836	GDRD848	GDRD860	GDRD872
9/125 ITU G.655 C & D	GBRD712	GBRD724	GBRD736	GBRD748	GBRD760	GBRD772	GDRD712	GDRD724	GDRD736	GDRD748	GDRD760	GDRD772
Std. plywood reel (non-returnable)	Ø 1250 x 688 mm, Weight 93.0 kg						Ø 1250 x 688 mm, Weight 93.0 kg					
Std. delivery length	2100 ± 100 m						2100 ± 100 m					

Ordering Information

Fiber Type/Count	Dry Core		Filled Core	
	96	144	96	144
62.5/125-OM1	GBRE196	GBRF144	GDRE196	GDRF144
50/125-OM2	GBRE296	GBRF244	GDRE296	GDRF244
50/125-OM3	GBRED96	GBRFD44	GDRED96	GDRFD44
50/125-OM4	GBREE96	GBRFE44	GDREE96	GDRFE44
9/125 ITU G.652D	GBRE896	GBRF844	GDRE896	GDRF844
9/125 ITU G.655 C & D	GBRE796	GBRF744	GDRE796	GDRF744
Std. plywood reel (non-returnable)	Ø 1400 x 900 mm, Weight 120.0 kg			
Std. delivery length	2100 ± 100 m			

Fiber Color Coding

No.		No.		No.	
1	Red	11	White	21	Grey + ring
2	Green	12	Aqua	22	Brown + ring
3	Blue	13	Red + ring	23	White + ring
4	Yellow	14	Green + ring	24	Aqua + ring
5	Violet	15	Blue + ring		
6	Pink	16	Yellow + ring		
7	Orange	17	Violet + ring		
8	Black	18	Pink + ring		
9	Grey	19	Orange + ring		
10	Brown	20	Black + ring		

Tube Color Coding	
No.	
1	Red
2	Green
3 to 12	White

**Universal Multi Loose Tube Cable
with Corrugated Steel Tape, Single Jacket**

GCCG, GCCD, GCCE, GCCF

A/I-DQ(ZN)(SR)H



Applications

- For outdoor and indoor use in structured (data) wiring systems such as (campus backbone)
- For outdoor and indoor use in networks for telecom, cable TV and/or broadcast
- Easy to install in ducts, tunnels and trenches by means of compressed air or pulling wire
- Suitable for direct burial

Features & Benefits

- Available in sizes from 2 to 144 fibers
- Jelly filled (non-dripping and silicon-free) loose tubes with primary coated optical fibers (Ø 250 ± 15 µm)
- Full dielectric construction, no grounding required
- Installation-friendly thanks to the cable core which is kept free of grease (dry interstices)
- High mechanical and full rodent protection provided by Corrugated Steel Tape (CST) armor
- Halogen Free jacket
- Length marking in meters for easy determination of the cable length

Cross Section

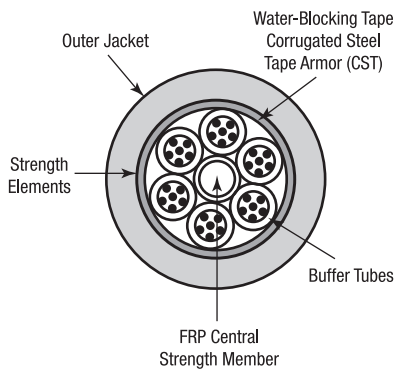

Specifications

IEC 60794-1-2	
Crush Resistance (E3):	22 kN/m
Min. Bend Radius installation (E6):	20 x Ø
Min. Bend Radius operation (E11):	20 x Ø
Temperature Range (F1):	
- Transport/Storage	-30 °C to +70 °C
- Installation	-5 °C to +50 °C
- Operation	-30 °C to +70 °C
Watertightness (F5):	Pass
Other	
Flame Retardant:	IEC 60332-3-22
Circuit Integrity:	IEC 60332-25, EN 50200
Halogen Free:	IEC 60754-1
Non Corrosive:	IEC 60754-2
Smoke Density:	IEC 61034-2

Characteristics

Loose Tube	Fiber Count	Diameter Tube (mm)	Max. Fibers per Tube	Watertightness in Core	Diameter (mm)	Weight (kg/km)	Tensile Strength (short term) N	Tensile Strength (permanent) N	Fire Load (kJ/m)
IEC 60794-1-2							E1	E1	
GCCG*xx	6 to 36	1.9	6	Dry	10.5	160	1750	580	2100
GCCD*xx	12 to 72	2.5	12	Dry	12.0	200	2400	800	2900
GCCE*xx	84 to 96	2.5	12	Dry	15.4	250	2500	830	3100
GCCF*xx	108 to 144	2.5	12	Dry	18.5	330	4000	1300	6000

Ordering Information

Fiber Type/Count	Dry Core				
	6	12	18	24	36
62.5/125-OM1	GCCG106	GCCG112	GCCG118	GCCG124	GCCG136
50/125-OM2	GCCG206	GCCG212	GCCG218	GCCG224	GCCG236
50/125-OM3	GCCGD06	GCCGD12	GCCGD18	GCCGD24	GCCGD36
50/125-OM4	GCCGE06	GCCGE12	GCCGE18	GCCGE24	GCCGE36
9/125 ITU G.652D	GCCG806	GCCG812	GCCG818	GCCG824	GCCG836
9/125 ITU G.655 C & D	GCCG706	GCCG712	GCCG718	GCCG724	GCCG736
Std. plywood reel (non-returnable)	Ø 1250 x 688 mm, Weight 93.0 kg				
Std. delivery length	2100 ± 100 m				

Fiber Type/Count	Dry Core					
	12	24	36	48	60	72
62.5/125-OM1	GCCD112	GCCD124	GCCD136	GCCD148	GCCD160	GCCD172
50/125-OM2	GCCD212	GCCD224	GCCD236	GCCD248	GCCD260	GCCD272
50/125-OM3	GCCDD12	GCCDD24	GCCDD36	GCCDD48	GCCDD60	GCCDD72
50/125-OM4	GCCDE12	GCCDE24	GCCDE36	GCCDE48	GCCDE60	GCCDE72
9/125 ITU G.652D	GCCD812	GCCD824	GCCD836	GCCD848	GCCD860	GCCD872
9/125 ITU G.655 C & D	GCCD712	GCCD724	GCCD736	GCCD748	GCCD760	GCCD772
Std. plywood reel (non-returnable)	Ø 1250 x 688 mm, Weight 93.0 kg					
Std. delivery length	2100 ± 100 m					

Ordering Information

Fiber Type/Count	Dry Core	
	96	144
62.5/125-OM1	GCCE196	GCCF144
50/125-OM2	GCCE296	GCCF244
50/125-OM3	GCCED96	GCCFD44
50/125-OM4	GCCEE96	GCCFE44
9/125 ITU G.652D	GCCE896	GCCF844
9/125 ITU G.655 C & D	GCCE796	GCCF744
Std. plywood reel (non-returnable)	Ø 1400 x 900 mm, Weight 120.0 kg	
Std. delivery length	2100 ± 100 m	

Fiber Color Coding

No.		No.		No.	
1	Red	11	White	21	Grey + ring
2	Green	12	Aqua	22	Brown + ring
3	Blue	13	Red + ring	23	White + ring
4	Yellow	14	Green + ring	24	Aqua + ring
5	Violet	15	Blue + ring		
6	Pink	16	Yellow + ring		
7	Orange	17	Violet + ring		
8	Black	18	Pink + ring		
9	Grey	19	Orange + ring		
10	Brown	20	Black + ring		

Tube Color Coding	
No.	
1	Red
2	Green
3 to 12	White

Outdoor Multi Loose Tube Cable with Corrugated Steel Tape, Single Jacket

GBCG, GBCD, GBCE, GBCF
GDCG, GDGD, GDCE, GDCF

A-DQ(ZN)(SR)2Y
A-DF(ZN)(SR)2Y



Applications

- For outdoor and indoor use in structured (data) wiring systems such as campus backbone
- For outdoor and indoor use in networks for telecom, cable TV and/or broadcast
- Easy to install in ducts, tunnels and trenches by means of compressed air or pulling wire
- Suitable for direct burial

Features & Benefits

- Available in sizes from 2 to 144 fibers
- Jelly filled (non-dripping and silicon-free) loose tubes with primary coated optical fibers ($\varnothing 250 \pm 15 \mu\text{m}$)
- Full dielectric construction, no grounding required
- Installation-friendly thanks to the cable core which is kept free of grease (dry interstices) for GBC types
- High mechanical and full rodent protection provided by Corrugated Steel Tape (CST) armor
- Polyethylene jacket
- Length marking in meters for easy determination of the cable length

Specifications

IEC 60794-1-2	
Crush Resistance (E3):	22 kN/m
Min. Bend Radius installation (E6):	20 x \varnothing
Min. Bend Radius operation (E11):	20 x \varnothing
Temperature Range (F1):	
- Transport/Storage	-30 °C to +70 °C
- Installation	-5 °C to +50 °C
- Operation	-30 °C to +70 °C
Watertightness (F5):	Pass

Cross Section

GBC

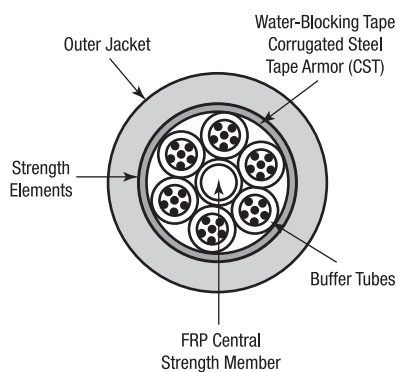

GDC

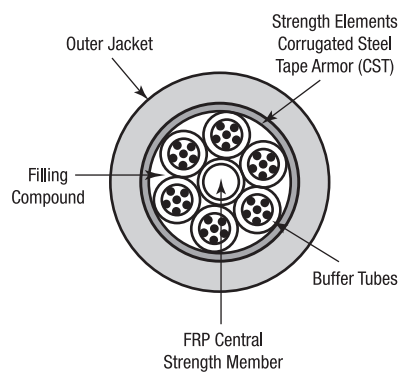

Characteristics

Loose Tube	Fiber Count	Diameter Tube (mm)	Max. Fibers per Tube	Watertightness in Core	Diameter (mm)	Weight (kg/km)	Tensile Strength (short term) N	Tensile Strength (permanent) N	Fire Load (kJ/m)
IEC 60794-1-2							E1	E1	
GBCG*xx	6 to 36	1.9	6	Dry	10.5	105	1750	550	3000
GDCG*xx	6 to 36	1.9	6	Filled	10.5	115	1750	580	3400
GBCD*xx	12 to 72	2.5	12	Dry	12.0	175	2400	800	4000
GDGD*xx	12 to 72	2.5	12	Filled	12.0	180	7000	800	4400
GBCE*xx	84 to 96	2.5	12	Dry	15.4	230	2500	830	4400
GDCE*xx	84 to 96	2.5	12	Filled	15.4	240	2500	830	4900
GBCF*xx	108 to 144	2.5	12	Dry	18.5	310	4000	1300	8000
GDCF*xx	108 to 144	2.5	12	Filled	18.5	325	4000	1300	8900

Ordering Information

Fiber Type/Count	Dry Core					Filled Core				
	6	12	18	24	36	6	12	18	24	36
62.5/125-OM1	GBCG106	GBCG112	GBCG118	GBCG124	GBCG136	GDCG106	GDCG112	GDCG118	GDCG124	GDCG136
50/125-OM2	GBCG206	GBCG212	GBCG218	GBCG224	GBCG236	GDCG206	GDCG212	GDCG218	GDCG224	GDCG236
50/125-OM3	GBCGD06	GBCGD12	GBCGD18	GBCGD24	GBCGD36	GDCGD06	GDCGD12	GDCGD18	GDCGD24	GDCGD36
50/125-OM4	GBCGE06	GBCGE12	GBCGE18	GBCGE24	GBCGE36	GDCGE06	GDCGE12	GDCGE18	GDCGE24	GDCGE36
9/125 ITU G.652D	GBCG806	GBCG812	GBCG818	GBCG824	GBCG836	GDCG806	GDCG812	GDCG818	GDCG824	GDCG836
9/125 ITU G.655 C & D	GBCG706	GBCG712	GBCG718	GBCG724	GBCG736	GDCG706	GDCG712	GDCG718	GDCG724	GDCG736
Std. plywood reel (non-returnable)	Ø 1250 x 688 mm, Weight 93.0 kg					Ø 1250 x 688 mm, Weight 93.0 kg				
Std. delivery length	2100 ± 100 m					2100 ± 100 m				

Fiber Type/Count	Dry Core						Filled Core					
	12	24	36	48	60	72	12	24	36	48	60	72
62.5/125-OM1	GBCD112	GBCD124	GBCD136	GBCD148	GBCD160	GBCD172	GDGD112	GDGD124	GDGD136	GDGD148	GDGD160	GDGD172
50/125-OM2	GBCD212	GBCD224	GBCD236	GBCD248	GBCD260	GBCD272	GDGD212	GDGD224	GDGD236	GDGD248	GDGD260	GDGD272
50/125-OM3	GBDD12	GBDD24	GBDD36	GBDD48	GBDD60	GBDD72	GDGD12	GDGD24	GDGD36	GDGD48	GDGD60	GDGD72
50/125-OM4	GBCE12	GBCE24	GBCE36	GBCE48	GBCE60	GBCE72	GDCDE12	GDCDE24	GDCDE36	GDCDE48	GDCDE60	GDCDE72
9/125 ITU G.652D	GBCD812	GBCD824	GBCD836	GBCD848	GBCD860	GBCD872	GDCD812	GDCD824	GDCD836	GDCD848	GDCD860	GDCD872
9/125 ITU G.655 C & D	GBCD712	GBCD724	GBCD736	GBCD748	GBCD760	GBCD772	GDCD712	GDCD724	GDCD736	GDCD748	GDCD760	GDCD772
Std. plywood reel (non-returnable)	Ø 1250 x 688 mm, Weight 93.0 kg						Ø 1250 x 688 mm, Weight 93.0 kg					
Std. delivery length	2100 ± 100 m						2100 ± 100 m					

Ordering Information

Fiber Type/Count	Dry Core		Filled Core	
	96	144	96	144
62.5/125-OM1	GBCE196	GBCF144	GDCE196	GDCF144
50/125-OM2	GBCE296	GBCF244	GDCE296	GDCF244
50/125-OM3	GBCED96	GBCFD44	GDCE96	GDCF44
50/125-OM4	GBCEE96	GBCFE44	GDCEE96	GDCF44
9/125 ITU G.652D	GBCE896	GBCF844	GDCE896	GDCF844
9/125 ITU G.655 C & D	GBCE796	GBCF744	GDCE796	GDCF744
Std. plywood reel (non-returnable)	Ø 1400 x 900 mm, Weight 120.0 kg			
Std. delivery length	2100 ± 100 m			

Fiber Color Coding

No.		No.		No.	
1	Red	11	White	21	Grey + ring
2	Green	12	Aqua	22	Brown + ring
3	Blue	13	Red + ring	23	White + ring
4	Yellow	14	Green + ring	24	Aqua + ring
5	Violet	15	Blue + ring		
6	Pink	16	Yellow + ring		
7	Orange	17	Violet + ring		
8	Black	18	Pink + ring		
9	Grey	19	Orange + ring		
10	Brown	20	Black + ring		

Tube Color Coding	
No.	
1	Red
2	Green
3 to 12	White

Universal Multi Loose Tube Cable with Corrugated Steel Tape, Double Jacket

GCDG, GCDD, GCDE, GCDF

A/I-DQ(ZN)H(SR)H



Applications

- For outdoor and indoor use in structured (data) wiring systems such as campus backbone
- For outdoor and indoor use in networks for telecom, cable TV and/or broadcast
- Easy to install in ducts, tunnels and trenches by means of compressed air or pulling wire
- Suitable for direct burial

Features & Benefits

- Available in sizes from 2 to 144 fibers
- Jelly filled (non-dripping and silicon-free) loose tubes with primary coated optical fibers ($\varnothing 250 \pm 15 \mu\text{m}$)
- Full dielectric construction, no grounding required
- Installation-friendly thanks to the cable core which is kept free of grease (dry interstices)
- High mechanical and full rodent protection provided by Corrugated Steel Tape (CST) armor
- Halogen Free jacket
- Length marking in meters for easy determination of the cable length

Cross Section

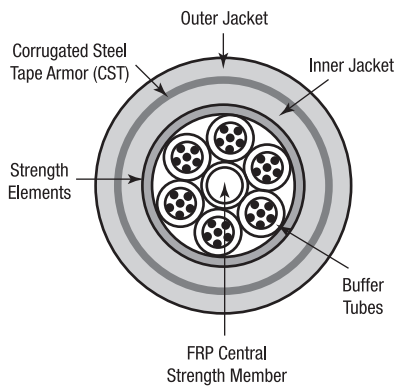

Specifications

IEC 60794-1-2	
Crush Resistance (E3):	22 kN/m
Min. Bend Radius installation (E6):	20 x \varnothing
Min. Bend Radius operation (E11):	20 x \varnothing
Temperature Range (F1):	
- Transport/Storage	-30 °C to +70 °C
- Installation	-5 °C to +50 °C
- Operation	-30 °C to +70 °C
Watertightness (F5):	Pass
Other	
Flame Retardant:	IEC 60332-3-22
Circuit Integrity:	EN 50200
Halogen Free:	IEC 60754-1
Non Corrosive:	IEC 60754-2
Smoke Density:	IEC 61034-2

Characteristics

Loose Tube	Fiber Count	Diameter Tube (mm)	Max. Fibers per Tube	Watertightness in Core	Diameter (mm)	Weight (kg/km)	Tensile Strength (short term) N	Tensile Strength (permanent) N	Fire Load (kJ/m)
IEC 60794-1-2							E1	E1	
GCDG*xx	6 to 36	1.9	6	Dry	13.2	195	1750	580	2800
GCDD*xx	12 to 72	2.5	12	Dry	15.2	280	2300	750	3900
GCDE*xx	84 to 96	2.5	12	Dry	17.4	340	2900	950	4700
GCDF*xx	108 to 144	2.5	12	Dry	20.5	430	3450	1150	7300

Ordering Information

Fiber Type/Count	Dry Core				
	6	12	18	24	36
62.5/125-OM1	GCDG106	GCDG112	GCDG118	GCDG124	GCDG136
50/125-OM2	GCDG206	GCDG212	GCDG218	GCDG224	GCDG236
50/125-OM3	GCDGD06	GCDGD12	GCDGD18	GCDGD24	GCDGD36
50/125-OM4	GCDGE06	GCDGE12	GCDGE18	GCDGE24	GCDGE36
9/125 ITU G.652D	GCDG806	GCDG812	GCDG818	GCDG824	GCDG836
9/125 ITU G.655 C & D	GCDG706	GCDG712	GCDG718	GCDG724	GCDG736
Std. plywood reel (non-returnable)	Ø 1250 x 688 mm, Weight 93.0 kg				
Std. delivery length	2100 ± 100 m				

Fiber Type/Count	Dry Core					
	12	24	36	48	60	72
62.5/125-OM1	GCDD112	GCDD124	GCDD136	GCDD148	GCDD160	GCDD172
50/125-OM2	GCDD212	GCDD224	GCDD236	GCDD248	GCDD260	GCDD272
50/125-OM3	GCDD112	GCDD124	GCDD136	GCDD148	GCDD160	GCDD172
50/125-OM4	GCDD112	GCDD124	GCDD136	GCDD148	GCDD160	GCDD172
9/125 ITU G.652D	GCDD812	GCDD824	GCDD836	GCDD848	GCDD860	GCDD872
9/125 ITU G.655 C & D	GCDD712	GCDD724	GCDD736	GCDD748	GCDD760	GCDD772
Std. plywood reel (non-returnable)	Ø 1250 x 688 mm, Weight 93.0 kg					
Std. delivery length	2100 ± 100 m					

Ordering Information

Fiber Type/Count	Dry Core	
	96	144
62.5/125-OM1	GCDE196	GCDF144
50/125-OM2	GCDE296	GCDF244
50/125-OM3	GCDE96	GCDF44
50/125-OM4	GCDEE96	GCDFE44
9/125 ITU G.652D	GCDE896	GCDF844
9/125 ITU G.655 C & D	GCDE796	GCDF744
Std. plywood reel (non-returnable)	Ø 1400 x 900 mm, Weight 120.0 kg	
Std. delivery length	2100 ± 100 m	

Fiber Color Coding

No.		No.		No.	
1	Red	11	White	21	Grey + ring
2	Green	12	Aqua	22	Brown + ring
3	Blue	13	Red + ring	23	White + ring
4	Yellow	14	Green + ring	24	Aqua + ring
5	Violet	15	Blue + ring	Tube Color Coding	
6	Pink	16	Yellow + ring	No.	
7	Orange	17	Violet + ring	1	Red
8	Black	18	Pink + ring	2	Green
9	Grey	19	Orange + ring	3 to 12	White
10	Brown	20	Black + ring		

Outdoor Multi Loose Tube Cable with Corrugated Steel Tape, Double Jacket

GBDG, GBDD, GBDE, GBDF
GDDG, GDDD, GDDE, GDDF

A-DQ(ZN)2Y(SR)2Y
A-DF(ZN)2Y(SR)2Y

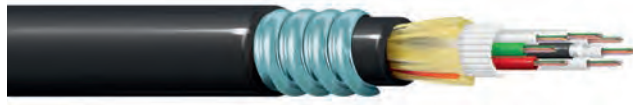

Applications

- For outdoor and indoor use in structured (data) wiring systems such as campus backbone
- For outdoor and indoor use in networks for telecom, cable TV and/or broadcast
- Easy to install in ducts, tunnels and trenches by means of compressed air or pulling wire
- Suitable for direct burial

Features & Benefits

- Available in sizes from 2 to 144 fibers
- Jelly filled (non-dripping and silicon-free) loose tubes with primary coated optical fibers ($\varnothing 250 \pm 15 \mu\text{m}$)
- Full dielectric construction, no grounding required
- Installation-friendly thanks to the cable core which is kept free of grease (dry interstices) for GBD types
- High mechanical and full rodent protection provided by Corrugated Steel Tape (CST) armor
- Polyethylene jacket
- Length marking in meters for easy determination of the cable length

Specifications

IEC 60794-1-2

Crush Resistance (E3):	22 kN/m
Min. Bend Radius installation (E6):	20 x \varnothing
Min. Bend Radius operation (E11):	20 x \varnothing
Temperature Range (F1):	
- Transport/Storage	-30 °C to +70 °C
- Installation	-5 °C to +50 °C
- Operation	-30 °C to +70 °C
Watertightness (F5):	Pass

Cross Section

GBD

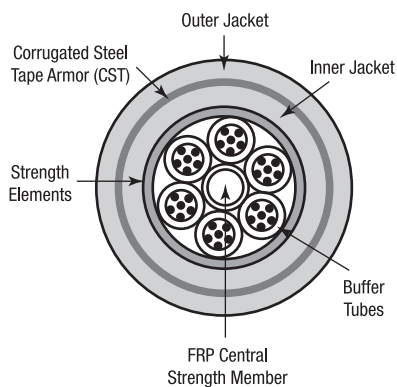

GDD

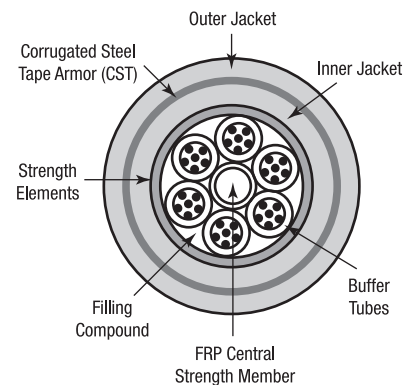

Characteristics

Tight Buffer	Fiber Count	Diameter Tube (mm)	Max. Fibers per Tube	Watertightness in Core	Diameter (mm)	Weight (kg/km)	Tensile Strength (short term) N	Tensile Strength (permanent) N	Fire Load (kJ/m)
IEC 60794-1-2							E1	E1	
GBDG*xx	6 to 36	1.9	6	Dry	13.2	155	1750	550	4700
GDDG*xx	6 to 36	1.9	6	Filled	13.0	160	1750	580	4900
GBDD*xx	12 to 72	2.5	12	Dry	15.2	200	2300	750	6100
GDDD*xx	12 to 72	2.5	12	Filled	15.0	205	2300	750	6500
GBDE*xx	84 to 96	2.5	12	Dry	17.4	310	2900	950	7600
GDDE*xx	84 to 96	2.5	12	Filled	17.1	285	2900	950	8100
GBDF*xx	108 to 144	2.5	12	Dry	20.5	310	3450	1150	8000
GDDF*xx	108 to 144	2.5	12	Filled	20.5	377	3450	1150	11400

Ordering Information

Fiber Type/Count	Dry Core					Filled Core				
	6	12	18	24	36	6	12	18	24	36
62.5/125-OM1	GBDG106	GBDG112	GBDG118	GBDG124	GBDG136	GDDG106	GDDG112	GDDG118	GDDG124	GDDG136
50/125-OM2	GBDG206	GBDG212	GBDG218	GBDG224	GBDG236	GDDG206	GDDG212	GDDG218	GDDG224	GDDG236
50/125-OM3	GBDGD06	GBDGD12	GBDGD18	GBDGD24	GBDGD36	GDDGD06	GDDGD12	GDDGD18	GDDGD24	GDDGD36
50/125-OM4	GBDGE06	GBDGE12	GBDGE18	GBDGE24	GBDGE36	GDDGE06	GDDGE12	GDDGE18	GDDGE24	GDDGE36
9/125 ITU G.652D	GBDG806	GBDG812	GBDG818	GBDG824	GBDG836	GDDG806	GDDG812	GDDG818	GDDG824	GDDG836
9/125 ITU G.655 C & D	GBDG706	GBDG712	GBDG718	GBDG724	GBDG736	GDDG706	GDDG712	GDDG718	GDDG724	GDDG736
Std. plywood reel (non-returnable)	Ø 1250 x 688 mm, Weight 93.0 kg					Ø 1250 x 688 mm, Weight 93.0 kg				
Std. delivery length	2100 ± 100 m					2100 ± 100 m				

Fiber Type/Count	Dry Core						Filled Core					
	12	24	36	48	60	72	12	24	36	48	60	72
62.5/125-OM1	GBDD112	GBDD124	GBDD136	GBDD148	GBDD160	GBDD172	GDDD112	GDDD124	GDDD136	GDDD148	GDDD160	GDDD172
50/125-OM2	GBDD212	GBDD224	GBDD236	GBDD248	GBDD260	GBDD272	GDDD212	GDDD224	GDDD236	GDDD248	GDDD260	GDDD272
50/125-OM3	GBDD12	GBDD24	GBDD36	GBDD48	GBDD60	GBDD72	GDDD12	GDDD24	GDDD36	GDDD48	GDDD60	GDDD72
50/125-OM4	GBDDE12	GBDDE24	GBDDE36	GBDDE48	GBDDE60	GBDDE72	GDDDE12	GDDDE24	GDDDE36	GDDDE48	GDDDE60	GDDDE72
9/125 ITU G.652D	GBDD812	GBDD824	GBDD836	GBDD848	GBDD860	GBDD872	GDDD812	GDDD824	GDDD836	GDDD848	GDDD860	GDDD872
9/125 ITU G.655 C & D	GBDD712	GBDD724	GBDD736	GBDD748	GBDD760	GBDD772	GDDD712	GDDD724	GDDD736	GDDD748	GDDD760	GDDD772
Std. plywood reel (non-returnable)	Ø 1250 x 688 mm, Weight 93.0 kg						Ø 1250 x 688 mm, Weight 93.0 kg					
Std. delivery length	2100 ± 100 m						2100 ± 100 m					

Ordering Information

Fiber Type/Count	Dry Core		Filled Core	
	96	144	96	144
62.5/125-OM1	GBDE196	GBDF144	GDDE196	GDDF144
50/125-OM2	GBDE296	GBDF244	GDDE296	GDDF244
50/125-OM3	GBDED96	GBDFD44	GDDED96	GDDFD44
50/125-OM4	GBDEE96	GBDFE44	GDDEE96	GDDFE44
9/125 ITU G.652D	GBDE896	GBDF844	GDDE896	GDDF844
9/125 ITU G.655 C & D	GBDE796	GBDF744	GDDE796	GDDF744
Std. plywood reel (non-returnable)	Ø 1400 x 900 mm, Weight 120.0 kg			
Std. delivery length	2100 ± 100 m			

Fiber Color Coding

No.		No.		No.	
1	Red	11	White	21	Grey + ring
2	Green	12	Aqua	22	Brown + ring
3	Blue	13	Red + ring	23	White + ring
4	Yellow	14	Green + ring	24	Aqua + ring
5	Violet	15	Blue + ring		
6	Pink	16	Yellow + ring		
7	Orange	17	Violet + ring		
8	Black	18	Pink + ring		
9	Grey	19	Orange + ring		
10	Brown	20	Black + ring		

Tube Color Coding	
No.	
1	Red
2	Green
3 to 12	White

Universal Multi Loose Tube Cable with Steel Wire Armor, Double Jacket

GCWG, GCWD

A/I-DQ(ZN)HBH



Applications

- For outdoor and indoor use in structured (data) wiring systems such as campus backbone
- For outdoor and indoor use in networks for telecom, cable TV and/or broadcast
- Easy to install in ducts, tunnels and trenches by means of compressed air or pulling wire
- Suitable for direct burial

Features & Benefits

- Available in sizes from 2 to 144 fibers
- Jelly filled (non-dripping and silicon-free) loose tubes with primary coated optical fibers ($\varnothing 250 \pm 15 \mu\text{m}$)
- Full dielectric construction, no grounding required
- Installation-friendly thanks to the cable which is kept free of grease (dry interstices)
- High mechanical and full rodent protection provided by Steel Wire Armor (SWA)
- Halogen Free jacket
- Length marking in meters for easy determination of the cable length

Cross Section

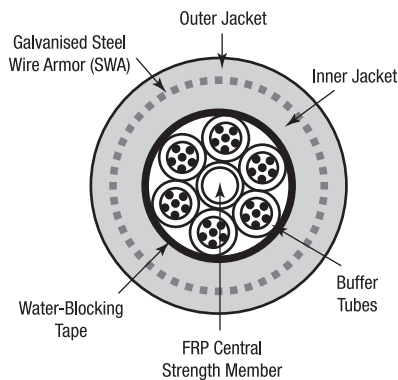

Specifications

IEC 60794-1-2	
Crush Resistance (E3):	22 kN/m
Min. Bend Radius installation (E6):	20 x \varnothing
Min. Bend Radius operation (E11):	20 x \varnothing
Temperature Range (F1):	
- Transport/Storage	-30 °C to +70 °C
- Installation	-5 °C to +50 °C
- Operation	-30 °C to +70 °C
Watertightness (F5):	Pass
Other	
Flame Retardant:	IEC 60332-3-22
Halogen Free:	IEC 60754-1
Non Corrosive:	IEC 60754-2
Smoke Density:	IEC 61034-2

Characteristics

Loose Tube	Fiber Count	Diameter Tube (mm)	Max. Fibers per Tube	Watertightness in Core	Steel Wire Diameter (mm)	Diameter (mm)	Weight (kg/km)	Tensile Strength (short term) N	Tensile Strength (permanent) N	Fire Load (kJ/m)
IEC 60794-1-2								E1	E1	
GCWG*xx	6 to 36	1.9	6	Dry	0.9	13.5	325	1750	580	3000
GCWD*xx	12 to 72	2.5	12	Dry	0.9	15.5	390	2300	750	4100

Ordering Information

Fiber Type/Count	Dry Core				
	6	12	18	24	36
62.5/125-OM1	GCWG106	GCWG112	GCWG118	GCWG124	GCWG136
50/125-OM2	GCWG206	GCWG212	GCWG218	GCWG224	GCWG236
50/125-OM3	GCWGD06	GCWGD12	GCWGD18	GCWGD24	GCWGD36
50/125-OM4	GCWGE06	GCWGE12	GCWGE18	GCWGE24	GCWGE36
9/125 ITU G.652D	GCWG806	GCWG812	GCWG818	GCWG824	GCWG836
9/125 ITU G.655 C & D	GCWG706	GCWG712	GCWG718	GCWG724	GCWG736
Std. plywood reel (non-returnable)	Ø 1250 x 688 mm, Weight 93.0 kg				
Std. delivery length	2100 ± 100 m				

Fiber Type/Count	Dry Core					
	12	24	36	48	60	72
62.5/125-OM1	GCWD112	GCWD124	GCWD136	GCWD148	GCWD160	GCWD172
50/125-OM2	GCWD212	GCWD224	GCWD236	GCWD248	GCWD260	GCWD272
50/125-OM3	GCWDD12	GCWDD24	GCWDD36	GCWDD48	GCWDD60	GCWDD72
50/125-OM4	GCWDE12	GCWDE24	GCWDE36	GCWDE48	GCWDE60	GCWDE72
9/125 ITU G.652D	GCWD812	GCWD824	GCWD836	GCWD848	GCWD860	GCWD872
9/125 ITU G.655 C & D	GCWD712	GCWD724	GCWD736	GCWD748	GCWD760	GCWD772
Std. plywood reel (non-returnable)	Ø 1250 x 688 mm, Weight 93.0 kg					
Std. delivery length	2100 ± 100 m					

Fiber Color Coding

No.	
1	Red
2	Green
3	Blue
4	Yellow
5	Violet

No.	
6	Pink
7	Orange
8	Black
9	Grey
10	Brown

No.	
11	White
12	Aqua
13	Red + ring
14	Green + ring
15	Blue + ring

No.	
16	Yellow + ring
17	Violet + ring
18	Pink + ring
19	Orange + ring
20	Black + ring

No.	
21	Grey + ring
22	Brown + ring
23	White + ring
24	Aqua + ring

Tube Color Coding

No.	
1	Red
2	Green
3 to 12	White

Outdoor Multi Loose Tube Cable with Steel Wire Armor, Double Jacket

GBWG, GBWD
GDWG, GDWD

A-DQ(ZN)2YB2Y
A-DF(ZN)2YB2Y

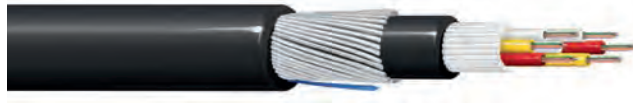

Applications

- For outdoor and indoor use in structured (data) wiring systems such as campus backbone
- For outdoor and indoor use in networks for telecom, cable TV and/or broadcast
- Easy to install in ducts, tunnels and trenches by means of compressed air or pulling wire
- Suitable for direct burial

Features & Benefits

- Available in sizes from 2 to 144 fibers
- Jelly filled (non-dripping and silicon-free) loose tubes with primary coated optical fibers ($\varnothing 250 \pm 15 \mu\text{m}$)
- Full dielectric construction, no grounding required
- Installation-friendly thanks to the cable core which is kept free of grease (dry interstices) for GBD types
- High mechanical and full rodent protection provided by Steel Wire Armor (SWA)
- Polyethylene jacket
- Length marking in meters for easy determination of the cable length

Specifications

IEC 60794-1-2	
Crush Resistance (E3):	22 kN/m
Min. Bend Radius installation (E6):	20 x \varnothing
Min. Bend Radius operation (E11):	20 x \varnothing
Temperature Range (F1):	
- Transport/Storage	-30 °C to +70 °C
- Installation	-5 °C to +50 °C
- Operation	-30 °C to +70 °C
Watertightness (F5):	Pass

Cross Section

GBW

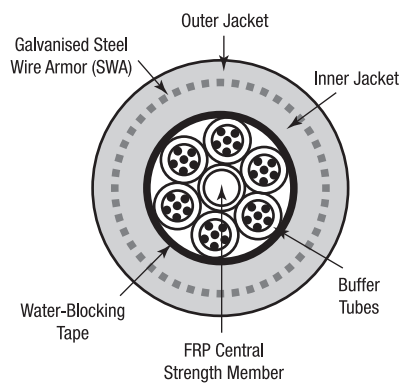

GDW

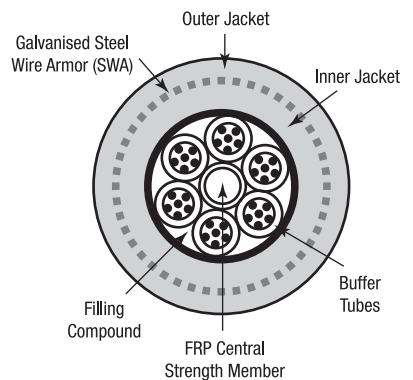

Characteristics

Loose Tube	Fiber Count	Diameter Tube (mm)	Max. Fibers per Tube	Watertightness in Core	Steel Wire Diameter (mm)	Diameter (mm)	Weight (kg/km)	Tensile Strength (short term) N	Tensile Strength (permanent) N	Fire Load (kJ/m)
IEC 60794-1-2								E1	E1	
GBWG*xx	6 to 36	1.9	6	Dry	0.9	13.5	255	1750	580	4900
GDWG*xx	6 to 36	1.9	6	Filled	0.9	13.5	260	1750	580	5100
GBWD*xx	12 to 72	2.5	12	Dry	0.9	15.5	300	2300	750	6300
GDWD*xx	12 to 72	2.5	12	Filled	0.9	15.5	320	2300	750	6700

Ordering Information

Fiber Type/Count	Dry Core					Filled Core				
	6	12	18	24	36	6	12	18	24	36
62.5/125-OM1	GBWG106	GBWG112	GBWG118	GBWG124	GBWG136	GDWG106	GDWG112	GDWG118	GDWG124	GDWG136
50/125-OM2	GBWG206	GBWG212	GBWG218	GBWG224	GBWG236	GDWG206	GDWG212	GDWG218	GDWG224	GDWG236
50/125-OM3	GBWGD06	GBWGD12	GBWGD18	GBWGD24	GBWGD36	GDWGD06	GDWGD12	GDWGD18	GDWGD24	GDWGD36
50/125-OM4	GBWGE06	GBWGE12	GBWGE18	GBWGE24	GBWGE36	GDWGE06	GDWGE12	GDWGE18	GDWGE24	GDWGE36
9/125 ITU G.652D	GBWG806	GBWG812	GBWG818	GBWG824	GBWG836	GDWG806	GDWG812	GDWG818	GDWG824	GDWG836
9/125 ITU G.655 C & D	GBWG706	GBWG712	GBWG718	GBWG724	GBWG736	GDWG706	GDWG712	GDWG718	GDWG724	GDWG736
Std. plywood reel (non-returnable)	Ø 1250 x 688 mm, Weight 93.0 kg					Ø 1250 x 688 mm, Weight 93.0 kg				
Std. delivery length	2100 ± 100 m					2100 ± 100 m				

Fiber Type/Count	Dry Core						Filled Core					
	12	24	36	48	60	72	12	24	36	48	60	72
62.5/125-OM1	GBWD112	GBWD124	GBWD136	GBWD148	GBWD160	GBWD172	GDWD112	GDWD124	GDWD136	GDWD148	GDWD160	GDWD172
50/125-OM2	GBWD212	GBWD224	GBWD236	GBWD248	GBWD260	GBWD272	GDWD212	GDWD224	GDWD236	GDWD248	GDWD260	GDWD272
50/125-OM3	GBWDD12	GBWDD24	GBWDD36	GBWDD48	GBWDD60	GBWDD72	GDWDD12	GDWDD24	GDWDD36	GDWDD48	GDWDD60	GDWDD72
50/125-OM4	GBWDE12	GBWDE24	GBWDE36	GBWDE48	GBWDE60	GBWDE72	GDWDE12	GDWDE24	GDWDE36	GDWDE48	GDWDE60	GDWDE72
9/125 ITU G.652D	GBWD812	GBWD824	GBWD836	GBWD848	GBWD860	GBWD872	GDWD812	GDWD824	GDWD836	GDWD848	GDWD860	GDWD872
9/125 ITU G.655 C & D	GBWD712	GBWD724	GBWD736	GBWD748	GBWD760	GBWD772	GDWD712	GDWD724	GDWD736	GDWD748	GDWD760	GDWD772
Std. plywood reel (non-returnable)	Ø 1250 x 688 mm, Weight 93.0 kg						Ø 1250 x 688 mm, Weight 93.0 kg					
Std. delivery length	2100 ± 100 m						2100 ± 100 m					

Fiber Color Coding

No.		No.		No.		No.		No.		No.		No.	
1	Red	6	Pink	11	White	16	Yellow + ring	21	Grey + ring	1	Red		
2	Green	7	Orange	12	Aqua	17	Violet + ring	22	Brown + ring	2	Green		
3	Blue	8	Black	13	Red + ring	18	Pink + ring	23	White + ring	3 to 12	White		
4	Yellow	9	Grey	14	Green + ring	19	Orange + ring	24	Aqua + ring				
5	Violet	10	Brown	15	Blue + ring	20	Black + ring						

Tube Color Coding

Outdoor Multi Loose Tube Cable with All Dielectric Self Supporting, Single Jacket

GAAG, GAAD, GAAE

A-DQ(ZN)2Y(T)



Applications

- All Dielectric Self Supporting cable (ADSS) for Outdoor use
- Suitable for installation between poles with a maximum span of 150 meters for GAAG, GAAD and GAAE, and 110 meter for GAAG
- Initial sag at +20 °C: 1% of span

Features & Benefits

- Available in sizes from 6 to 144 fibers
- Jelly filled (non-dripping and silicon-free) loose tubes with primary coated optical fibres ($\varnothing 250 \pm 15 \mu\text{m}$)
- Full dielectric construction, no grounding required
- Aramid yarns for tensile strength
- Installation-friendly because of the cable core kept free of grease (dry interstices)
- Polyethylene jacket
- Length marking in meters for easy determination of the cable length

Cross Section

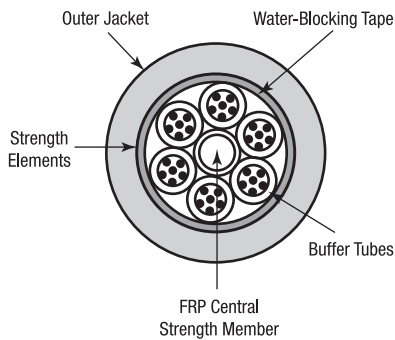

Specifications

IEC 60794-1-2	
Crush Resistance (E3):	15 kN/m
Min. Bend Radius installation (E6):	20 x \varnothing
Min. Bend Radius operation (E11):	20 x \varnothing
Temperature Range (F1):	
– Transport/Storage	-30 °C to +70 °C
– Installation	-5 °C to +50 °C
– Operation	-30 °C to +70 °C
Watertightness (F5):	Pass

Characteristics

Loose Tube	Fiber Count	Diameter Tube (mm)	Max. Fibers per Tube	Watertightness in Core	Diameter (mm)	Weight (kg/km)	Tensile Strength (short term) N	Tensile Strength (permanent) N	Fire Load (kJ/m)
IEC 60794-1-2							E1	E1	
GAAG*xx	6 to 36	1.9	6	Dry	10.3	72	2450	800	3000
GAAD*xx	12 to 72	2.5	12	Dry	12.2	99	2700	900	4000
GAAE*xx	84 to 96	2.5	12	Dry	13.8	132	3450	1150	4400

Ordering Information

Fiber Type/Count	Dry Core				
	6	12	18	24	36
62.5/125-OM1	GAAG106	GAAG112	GAAG118	GAAG124	GAAG136
50/125-OM2 BW 600/1200	GAAG206	GAAG212	GAAG218	GAAG224	GAAG236
50/125-OM3	GAAGD06	GAAGD12	GAAGD18	GAAGD24	GAAGD36
50/125-OM4	GAAGE06	GAAGE12	GAAGE18	GAAGE24	GAAGE36
9/125 ITU G.652D	GAAG806	GAAG812	GAAG818	GAAG824	GAAG836
9/125 ITU G.655 C&D	GAAG706	GAAG712	GAAG718	GAAG724	GAAG736
Std. plywood reel (non-returnable)	Ø 1250 x 688 mm, Weight 93.0 kg				
Std. delivery length	2100 ± 100 m				

Fiber Type/Count	Dry Core					
	12	24	36	48	60	72
62.5/125-OM1	GAAD112	GAAD124	GAAD136	GAAD148	GAAD160	GAAD172
50/125-OM2 BW 600/1200	GAAD212	GAAD224	GAAD236	GAAD248	GAAD260	GAAD272
50/125-OM3	GAADD12	GAADD24	GAADD36	GAADD48	GAADD60	GAADD72
50/125-OM4	GAAD12	GAAD24	GAAD36	GAAD48	GAAD60	GAAD72
9/125 ITU G.652D	GAAD812	GAAD824	GAAD836	GAAD848	GAAD860	GAAD872
9/125 ITU G.655 C & D	GAAD712	GAAD724	GAAD736	GAAD748	GAAD760	GAAD772
Std. plywood reel (non-returnable)	Ø 1250 x 688 mm, Weight 93.0 kg					
Std. delivery length	2100 ± 100 m					

Ordering Information

Fiber Type/Count	Dry Core	
	84	96
62.5/125-OM1	GAAE184	GAAE196
50/125-OM2 BW 600/1200	GAAE284	GAAE296
50/125-OM3	GAAED84	GAAED96
50/125-OM4	GAAEE84	GAAEE96
9/125 ITU G.652D	GAAE884	GAAE896
9/125 ITU G.655 C & D	GAAE784	GAAE796
Std. plywood reel (non-returnable)	Ø 1400 x 900 mm, Weight 120.0 kg	
Std. delivery length	2100 ± 100 m	

Fiber Color Coding

No.		No.		No.	
1	Red	5	Violet	9	Grey
2	Green	6	Pink	10	Brown
3	Blue	7	Orange	11	White
4	Yellow	8	Black	12	Aqua

Tube Color Coding

1	Red
2	Green
3 to 12	White

Mechanical Test Procedures

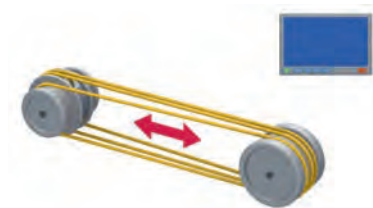

Tensile Performance

The tensile performance method monitors the attenuation variation and evaluates elongation of the cable which is subject to an increasing traction load during installation and operation.

- Standards: IEC 60794-1-2 E1 (Future IEC 60794-1-21 E1)

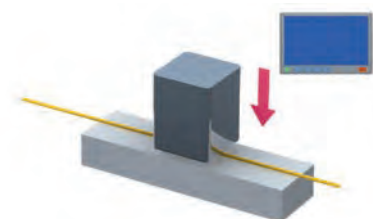

Crush Resistance

This test aims to verify the behavior of the cable and the fibers that are subject to compression during operation and/or installation. During the test, a cable sample is compressed (in a transverse direction) between a fixed and a mobile base, where an even force is applied on a cable section.

- Standards: IEC 60794-1-2 E3 (Future IEC 60794-1-21 E3)

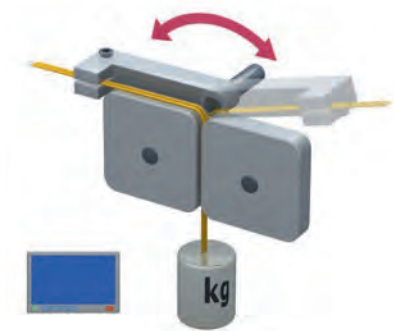

Repeated Bending

The test evaluates the ability of an optical fiber cable to withstand repeated bending. The cable is repeatedly bent at 90° to reproduce working conditions and to create stress.

- Standards: IEC 60794-1-2 E6 (Future IEC 60794-1-21 E6)

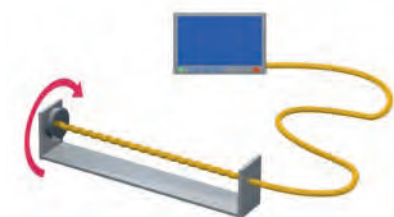

Torsion

The torsion test is aimed at evaluating the ability of an optical fiber cable to withstand mechanical twisting. The test is carried out on a cable sample anchored to a fixed support and to a rotating support and by applying a sample load. The cable is then twisted in clockwise and anti-clockwise rotations to examine the possibility of physical damage.

- Standards: IEC 60794-1-2 E7 (Future IEC 60794-1-21 E7)

Environmental Test Procedures

Temperature Cycling

The temperature cycling test measures the ability of an optical fiber cable to provide stable operations during exposure to changing temperatures. Test conditions are regulated to simulate the worst conditions for such temperature changes to measure the possible effects on the optical and mechanical performance of a cable.

- Standards: IEC 60794-1-2 F1 (Future IEC 60794-1-22 F1)

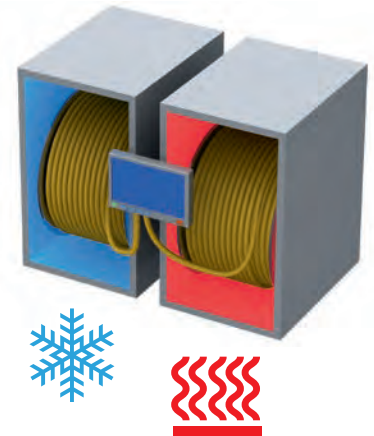

Water Penetration

Water penetration test examines the effectiveness of use of water blocking materials in fiber optic cable. This test is used as assurance criteria for the cable's resistance to longitudinal water penetration.

- Standards: IEC 60794-1-2 F5B (future IEC 60794-1-22 F5B/C)

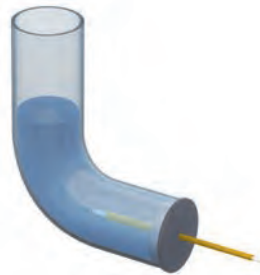

Fire Performance Test Procedures



Fire Propagation on a Vertical Single Cable

This test evaluates the flame retardant characteristics of a single cable. Depending on the cable diameter and weight, a regulated flame is continuously applied for a certain amount of time to the cable. The cable needs to extinguish itself and the burnt portion of the cable should not reach the top of the sample for the cable to pass the test.

- Standard: IEC 60332-1



Fire Propagation on a Vertical Cable Bundle

This test examines the flame retardant characteristics of a group of bundled cables (depending on the volume of flammable materials) fixed on a vertical 3.5m ladder and flame is applied to the bundle for 20 or 40 minutes. The height of the fire damage should not exceed 2.5 m for the bundled cables to pass the test.

- Standard: IEC 60332-3

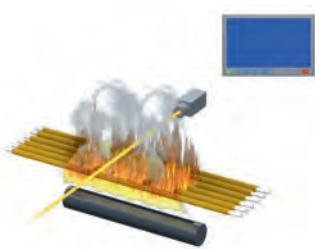

Smoke Emission

Smoke emissions considerably reduce the visibility in case of fires. This test measures the density of smoke emitted from burning cables and this is determined with an optical transmission measurement.

- Standard: IEC 61034

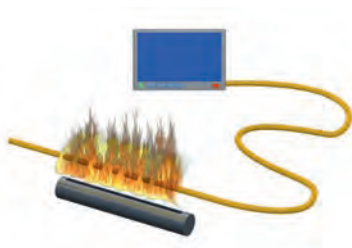

Fire Test with Circuit Integrity

It is vital for some circuits to maintain the power supply for the activation of safety equipment in case of fires. This test determines the circuit integrity of a cable during and after a prolonged fire. The cable passes the test when there is continuous circuit integrity during and after the test.

- Standard: IEC 60331-25



Patching and Termination MIPP – The Industrial-strength Patch Panel



Section Table of Contents

Patching and Termination	
MIPP – The Industrial-strength Patch Panel	
Overview	332–333
MIPP Fiber Splice Box	334
Overview	334
Standard Part Number Reference Guide	335
Standard Part Number Reference List	336–337
MIPP Copper Patch Panel	338
Overview	338
Standard Part Number Reference Guide	339
Standard Part Number Reference List	339
MIPP Mix	340
Overview	340
Standard Part Number Reference List	341
Accessories	342

MIPP – The Industrial-strength Patch Panel



Belden's Modular Industrial Patch Panel (MIPP™) is a robust and versatile termination panel for both fiber and copper cables that need to be connected from operating environment to active equipment. Easily installed on any standard 35 mm DIN rail, MIPP features high port-density to meet expanding network connectivity needs within limited space. MIPP is Belden's high-quality solution for performance-critical Industrial Ethernet Applications.

Product Features

Robust Quality

- Lightweight, high strength aluminium housing, able to withstand temperatures from -20 °C to +70 °C
- UL approval (UL 1863)

Fiber Splice Box, Copper Patch Panel or Combination Applications

- MIPP comes as either a Fiber Splice Box, Copper Patch Panel, or a mix of both
- LC, SC, ST, SC and ST metal and E-2000 fiber duplex adapters multimode (OM1, OM2, OM3 and OM4) and singlemode (OS2 and OS2/APC)
- RJ45 copper keystone jacks (Shielded and Unshielded, Cat 5e, Cat 6, Cat 6A) and RJ45 copper coupler (shielded and unshielded, Cat 6A)

Easy Installation and Maintenance

- Splice tray and multiple fingers for easy fiber management
- Cable entry in two places (top or bottom) for ease of use and choice of placement in cabinet
- Three cable entries for single fiber module, for ring topology applications
- Double fiber module accommodates hybrid fiber cables, with single mode and multi mode fibers

Best Fit

- Available as part of a system with market leading Hirschmann switches and high performance Belden cabling for optimum reliability in Industrial Ethernet networks

Applications

The MIPP is ideal for use in a wide range of industrial applications requiring maximum system reliability and flexibility. The industrial design makes it highly suited for use in Machine Building, Transportation, Alternative Power Generation, Power Transmission & Distribution, and Oil & Gas markets, as well as for general use in enterprise, buildings and other applications.

MIPP – The Industrial-strength Patch Panel

The market shows a clear trend in the growing use of both Industrial Ethernet and fiber infrastructures in industrial networks. The Modular Industrial Patch Panel (MIPP) is the efficient termination and patching tool for an efficient, low maintenance and secure connection between cables and switches in performance critical applications.

Robust Quality

The durable MIPP panels are constructed of lightweight, high strength aluminium, securely protecting copper and optical fiber connections under the harshest industrial conditions. The housing is able to withstand temperatures from -20 °C to +70 °C and is resistant to shocks and vibrations. The patch panel's industrial quality guarantees a secure termination point for reliable industrial Ethernet connectivity.

Fiber, Copper, Both

MIPP comes as either a Fiber Splice Box, Copper Patch Panel, or a combination. Where both fiber and copper cables are needed together the design enables simply connecting both to a single panel. MIPP allows flexible network design for network engineers and flexible patching for system installers.

Easy Installation and Maintenance

The smart housing design allows quick and flexible installation of the MIPP on a DIN rail or a wall. Maintenance is equally easy, since the modules can be individually removed without dismantling the MIPP from the DIN rail or wall mount. Just take out the modules that need work and save precious time.

Future Proof

As network design may change over time, MIPP allows for modifications by simply swapping modules to meet the new design required. Installing a MIPP with blind* modules readies the solution for any extensions or modifications to come. MIPP is the future proof termination and patching solution for dynamic industries.

Save Space

Belden knows the importance of cabinet space in industrial sites. Continuous growth of system networks requires smart use of the existing space. MIPP is designed to fit. Thanks to its narrow housing design the required space is kept to a minimum. With three cable entry points (top and bottom) there is no need for special cabinet design or positioning.

Best Fit

MIPP is the reliable solution for connecting Belden cables and Hirschmann switches.

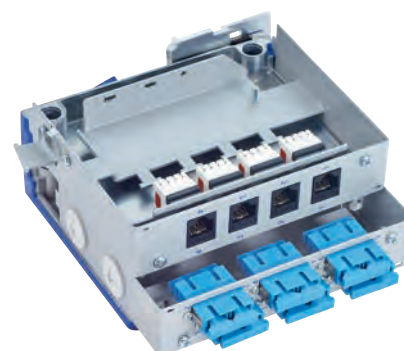

Benefits

- 1. Robustness:** durable UL certified (UL 1863) solution for linking Hirschmann switches to Belden cabling with a guaranteed lifetime of well over 10 years.
- 2. Versatility:** suitable in nearly any industrial application where fiber splicing, copper termination or both are required. A single MIPP allows for termination and patching of:
 - Up to 72 fiber cables: MIPP Fiber Splice Box
 - Up to 24 copper cables: MIPP Copper Patch Panel
- 3. Ease of use:** mounted on a DIN rail or wall, any module can be individually extracted from the housing for maintenance actions.
- 4. Future proof:** simply swap modules to meet new network demands or add blind modules at initial installation.
- 5. Save space and cost:** high port density and multiple cable entry points.

MIPP Fiber Splice Box

Save cost and space: high port density and multiple cable entry points minimize required cabinet space.

MIPP Fiber Splice Box guarantees efficient fiber termination and is designed for use in a wide range of industrial applications. MIPP Fiber Splice Box accommodates various fiber types and connectors: LC, SC, SC metal, ST, ST metal and E-2000 fiber duplex adapters.

MIPP Fiber Splice Box gives you everything you need

- Splice tray and multiple fingers for easy fiber management
- Up to three cable entries for single fiber module, ideal for ring topology applications
- High port density with up to 72 fiber counts (for a single MIPP) for efficient usage of space

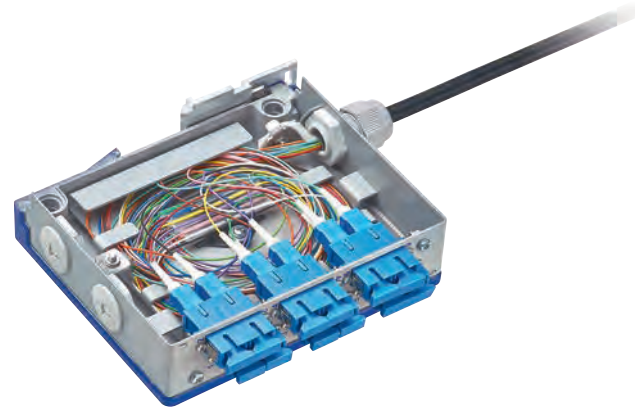

Accessories for the MIPP Fiber Splice Box
Brilliance connectors

Type of Adapters

Single Fiber Modules (up to 12 fiber connections)

- 6 x SC duplex adapters
- 6 x SC metal duplex adapters
- 6 x LC duplex adapters
- 6 x ST duplex adapters
- 6 x ST metal duplex adapters
- 6 x E-2000 duplex adapters

Double Fiber Modules (up to 24 fiber connections)

- 12 x SC duplex adapters
- 12 x SC metal duplex adapters
- 12 x LC duplex adapters
- 12 x ST duplex adapters
- 12 x ST metal duplex adapters
- 12 x E-2000 duplex adapters

Fiber Applications

- Multimode: OM1, OM2, OM3 and OM4
- Singlemode: OS2 and OS2/APC

MIPP Fiber Splice Box is UL certified (UL 1863).

MIPP Fiber Splice Box Single Module

Standard Part Number Reference Guide

1	System build-up	MIPP Fiber Splice Box								
2	Number of Fibers	Single Module (Fiber count up to 12)								
3	Mounting Type	DIN rail (wall mount also available)								
4	Adapter	LC *				SC *				
5	Application	OM1	OM2	OM3	OS2	OM1	OM2	OM3	OS2	
	Color	Beige	Beige	Aqua	Blue	Beige	Beige	Aqua	Blue	
	Adapter sleeve material	Phosphor Bronze		Ceramic		Phosphor Bronze		Ceramic		
	Part Number	MIPP-01-030	MIPP-01-033	MIPP-01-003	MIPP-01-005	MIPP-01-007	MIPP-01-010	MIPP-01-012	MIPP-01-013	
	Accessories									
	Pigtails	Part Number	MIPP-01-031	MIPP-01-002	MIPP-01-004	MIPP-01-006	MIPP-01-008	MIPP-01-011	MIPP-01-037	MIPP-01-014
	Brilliance Connectors	Part Number	MIPP-01-032	MIPP-01-001	MIPP-01-034	MIPP-01-035	MIPP-01-036	MIPP-01-009	MIPP-01-038	MIPP-01-039

4	Adapter	ST *				
5	Application	OM1	OM2	OM3	OS2	
	Color	Beige	Beige	Aqua	Blue	
	Adapter sleeve material	Phosphor Bronze		Ceramic		
	Part Number	MIPP-01-015	MIPP-01-042	MIPP-01-017	MIPP-01-019	
	Accessories					
	Pigtails	Part Number	MIPP-01-040	MIPP-01-016	MIPP-01-018	MIPP-01-045
	Brilliance Connectors	Part Number	MIPP-01-041	MIPP-01-043	MIPP-01-044	MIPP-01-046

* SC and ST available also in metal adapters via Customer Service
 * E-2000 adapters available via Customer Service
 * OM4 fibers available via Customer Service

Material	Steel (powder coated)
Weight (gr)	560
Protection Class	IP40
Cable Entry	<ul style="list-style-type: none"> • 3 possible cable entries • 1 M16 Gland installed • 1 extra M16 Gland supplied
Diameter Cable	3 to 10 mm
Cable Types	loose-tube, mini-breakout or breakout cables of up to 12 fibers
Mating Cycles	500 cycles (E-2000 1000 cycles)

MIPP Fiber Splice Box
Standard Part Number Reference List

Part No.	Max Number Fibers	Type of Module	Mounting Type		Adapter Type				Application					Accessories		
			DIN Rail	Wall Mount	LC	SC	ST	E-2000™	Multimode			Singlemode		Pigtails	Brilliance Connectors	
									OM1	OM2	OM3	OS2	OS2/A PC			
MIPP-00-001	–	No Housing – Blind Module														
MIPP-00-002	12	No Housing Single			•					•						
MIPP-00-003	12	No Housing Single				•				•						
MIPP-00-004	12	No Housing Single				•					•					
MIPP-01-030	12	1 x Single	•		•					•						
MIPP-01-031	12	1 x Single	•		•					•					•	
MIPP-01-032	12	1 x Single	•		•					•						•
MIPP-01-033	12	1 x Single	•		•					•						
MIPP-01-002	12	1 x Single	•		•					•					•	
MIPP-01-001	12	1 x Single	•		•					•						•
MIPP-01-003	12	1 x Single	•		•						•					
MIPP-01-004	12	1 x Single	•		•						•				•	
MIPP-01-034	12	1 x Single	•		•						•					•
MIPP-01-005	12	1 x Single	•		•							•				
MIPP-01-006	12	1 x Single	•		•							•			•	
MIPP-01-035	12	1 x Single	•		•							•				•
MIPP-01-007	12	1 x Single	•			•				•						
MIPP-01-008	12	1 x Single	•			•				•					•	
MIPP-01-036	12	1 x Single	•			•				•						•
MIPP-01-010	12	1 x Single	•			•				•						
MIPP-01-011	12	1 x Single	•			•				•					•	
MIPP-01-009	12	1 x Single	•			•				•						•
MIPP-01-012	12	1 x Single	•			•					•					
MIPP-01-037	12	1 x Single	•			•					•				•	
MIPP-01-038	12	1 x Single	•			•					•					•
MIPP-01-013	12	1 x Single	•			•						•				
MIPP-01-014	12	1 x Single	•			•						•			•	
MIPP-01-039	12	1 x Single	•			•						•				•
MIPP-01-015	12	1 x Single	•				•			•						
MIPP-01-040	12	1 x Single	•				•			•					•	
MIPP-01-041	12	1 x Single	•					•		•						•
MIPP-01-042	12	1 x Single	•						•	•						
MIPP-01-016	12	1 x Single	•					•		•					•	
MIPP-01-043	12	1 x Single	•						•	•						•
MIPP-01-017	12	1 x Single	•								•					
MIPP-01-018	12	1 x Single	•								•				•	
MIPP-01-044	12	1 x Single	•									•				•
MIPP-01-019	12	1 x Single	•									•				
MIPP-01-045	12	1 x Single	•									•			•	
MIPP-01-046	12	1 x Single	•									•				•

MIPP Fiber Splice Box

Standard Part Number Reference List (*continued*)

Part No.	Max Number Fibers	Type of Module	Mounting Type		Adapter Type				Application					Accessories	
			DIN Rail	Wall Mount	LC	SC	ST	E-2000™	Multimode			Singlemode		Pigtails	Brilliance Connectors
									OM1	OM2	OM3	OS2	OS2/A PC		
MIPP-10-001	1 x 24	1 x Double	•					•					•		
MIPP-10-002	1 x 24	1 x Double	•		•					•					
MIPP-10-003	1 x 24	1 x Double	•		•						•				
MIPP-10-004	1 x 24	1 x Double	•		•							•			
MIPP-10-005	1 x 24	1 x Double	•		•								•		
MIPP-10-006	1 x 24	1 x Double	•			•			•						
MIPP-10-007	1 x 24	1 x Double	•			•			•					•	
MIPP-10-008	1 x 24	1 x Double	•			•					•				
MIPP-10-012	1 x 24	1 x Double	•			•						•			
MIPP-10-009	1 x 24	1 x Double	•			•							•		
MIPP-10-010	1 x 24	1 x Double	•				•		•					•	
MIPP-10-011	1 x 24	1 x Double		•		•			•						
MIPP-02-001	1 x 24	2 x Single	•		2x					2x					
MIPP-02-002	1 x 24	2 x Single	•		2x					2x				2x	
MIPP-02-003	1 x 24	2 x Single	•			2x			2x						
MIPP-02-004	1 x 24	2 x Single	•			2x			2x					2x	
MIPP-02-006	1 x 24	2 x Single	•			2x			2x						
MIPP-02-008	1 x 24	2 x Single	•			2x					2x				
MIPP-20-001	48	2 x Double	•		2x						2x				
MIPP-04-001	48	4 x Single	•		4x					4x					

MIPP Copper Patch Panel

Perfect fit to the Belden cables and Hirschmann product families.

MIPP Copper Patch Panel ensures maximum reliability for Industrial Ethernet and PROFINET networks. The MIPP Copper Patch Panel compliments the market leading Hirschmann switches and high performance Belden cabling solutions by enabling cables to be terminated and linked to active equipment using DataTuff patch cords, in an organised and structured manner.

MIPP Copper Patch Panel covers all your copper termination and patching needs

- High variety of media and connectors:
 - RJ45 copper keystone jacks (unshielded and shielded, Cat 5e, Cat 6, Cat 6A)
 - RJ45 copper coupler (unshielded and shielded, Cat 6A)
- Suitable in nearly any industrial application thanks to the robust aluminium housing (resisting an operating temperature range of -20 °C to +70 °C)



Accessories for the MIPP Copper Patch Panel DataTuff for cables and patch cords

Type of Keystones

Single Copper Modules

- 2 or 4 x RJ45 keystone unshielded
- 2 or 4 x RJ45 keystone shielded
- 2 or 4 x RJ45 coupler unshielded
- 2 or 4 x RJ45 coupler shielded

Type of Cable Categories

- Cat 5e unshielded and shielded
- Cat 6 unshielded and shielded
- Cat 6A unshielded and shielded

MIPP Copper Patch Panel is UL certified (UL 1863).

MIPP Copper Patch Panel Single Module
Standard Part Number Reference Guide

1	System build-up	MIPP Copper Patch Panel							
2	Number of Copper Cables	Single Module (Copper cables up to 4)							
3	Mounting Type	DIN rail (wall mount also available)							
4	Keystone	Unshielded KeyConnect			Shielded KeyConnect			Unshielded Couplers	Shielded Couplers
5	Category	CAT 5e	CAT 6	Cat 6 _A	CAT 5e	CAT 6	Cat 6 _A	Cat 6 _A	Cat 6 _A
	Weight (gr)	515			640			515	640
	Connector Part Number	AX101310	AX101321	AX102283	AX104595	AX104596	AX104562	AX104024	AX104501
	4 Keystone* Part Number	MIPP-01-021	MIPP-01-020	MIPP-01-022	MIPP-01-023	MIPP-01-024	MIPP-01-025	MIPP-01-026	MIPP-01-027

*Available also with 2 keystones via Customer Service

Material	Steel (powder coated)
Protection Class	IP20
Cable Entry	<ul style="list-style-type: none"> • 1 cable entry point • with tie wrap fixing latch
Diameter Cable	4 x 7.5 mm
Mating Cycles	750 cycles

Standard Part Number Reference List

Part No.	Max Number Fibers	Type of Module	Mounting Type DIN Rail	Keystone Type				Cable Type		
				KeyConnect		Couplers		Cat 5e	Cat 6	Cat 6 _A
				Unshielded	Shielded	Unshielded	Shielded			
MIPP-00-001	-	No Housing - Blind Module								
MIPP-00-005	4	No Housing Single			•			•		
MIPP-00-006	4	No Housing Single			•				•	
MIPP-01-021	4	1 x Single	•		•			•		
MIPP-01-020	4	1 x Single	•		•				•	
MIPP-01-022	4	1 x Single	•		•					•
MIPP-01-023	4	1 x Single	•			•		•		
MIPP-01-024	4	1 x Single	•			•			•	
MIPP-01-025	4	1 x Single	•			•				•
MIPP-01-026	4	1 x Single	•				•			•
MIPP-01-027	4	1 x Single	•						•	•
MIPP-02-010	8	2 x Single	•		•				•	
MIPP-04-002	16	4 x Single	•					4x		4x

MIPP Mix



Scan to view the MIPP Mix Video

The market shows a clear trend in the growing use of both Industrial Ethernet and fiber infrastructures in industrial networks. MIPP™ addresses this by allowing the connection of both fiber and copper cables in a single solution*. Specifically designed for industrial use, MIPP™'s functionality and reliability can make a significant contribution to the uptime and availability of performancecritical systems.

MIPP Fiber Splice Box and Copper Patch Panel for varying industrial networking needs.



* Up to 6 single modules, 3 double modules or a combination can be used in one MIPP™



MIPP Mix

Standard Part Number Reference List

Part No.	Type of Module	Mounting Type	Module 1	Module 2	Module 3	Module 4	Module 5
		DIN Rail					
MIPP-00-001	No Housing - Blind Module						
MIPP-02-011	2 x Single	•	Fiber: LC OM2 with Pigtailed	Blind Module			
MIPP-02-005	2 x Single	•	Fiber: SC OM1 with Pigtailed	Copper: Unshielded Keystones Cat 5e			
MIPP-02-007	2 x Single	•	Fiber: SC OS2	Copper: Unshielded Keystones Cat 6			
MIPP-02-009	2 x Single	•	Fiber: SC OS2 with Pigtailed	Copper: Unshielded Keystones Cat 5e			
MIPP-03-001	3 x Single	•	Copper: Unshielded Coupler, Cat 6	Copper: Unshielded Coupler, Cat 6	Fiber: SC OM3		
MIPP-21-001	3 x Single	•	Copper: Unshielded Coupler, Cat 5e	Fiber Double Module: ST OM2	Fiber Double Module: ST OM2		
MIPP-05-001	5 x Single	•	Fiber: LC OS2 with Pigtailed	Copper: Unshielded Coupler, Cat 6	Blind Module	Blind Module	Blind Module

Accessories

MIPP Fiber Splice Box Accessories

Pigtails			
SC	LC	ST	E-2000
1 or 2 packs of 12 pigtails, 900 micron, 0.6 mtr in 12 different colours: <ul style="list-style-type: none"> • SC/UPC SM 9/125, OS2 • SC/APC SM 9/125, OS2 • SC/PC MM 62.5/125, OM1 • SC/PC MM 50/125, OM2 • SC/PC MM 50/125, OM3 • SC/PC MM 50/125, OM4 	1 or 2 packs of 12 pigtails, 900 micron, 0.6 mtr in 12 different colours: <ul style="list-style-type: none"> • LC/UPC SM 9/125, OS2 • LC/APC SM 9/125, OS2 • LC/PC MM 62.5/125, OM1 • LC/PC MM 50/125, OM2 • LC/PC MM 50/125, OM3 • LC/PC MM 50/125, OM4 	1 or 2 packs of 12 pigtails, 900 micron, 0.6 mtr in 12 different colours: <ul style="list-style-type: none"> • ST/UPC SM 9/125, OS2 • ST/PC MM 62.5/125, OM1 • ST/PC MM 50/125, OM2 • ST/PC MM 50/125, OM3 • ST/PC MM 50/125, OM4 	1 or 2 packs of 12 pigtails, 900 micron, 0.6 mtr in 12 different colours: <ul style="list-style-type: none"> • E-2000/UPC SM 9/125, OS2 • E-2000/APC SM 9/125, OS2 • E-2000/PC MM 62.5 ,OM1 • E-2000/PC MM 50/125,OM2 • E-2000/PC MM 50/125,OM3 • E-2000/PC MM 50/125,OM4
Brilliance Field Installable Connectors			
12 or 24 brilliance connectors SC, 900 micron: <ul style="list-style-type: none"> • OS2 Blue – AX105208 • OM1 Beige – AX105205 • OM2 Black – AX105206 • OM3/4 Aqua – AX105207 	12 or 24 brilliance connectors LC, 900 micron: <ul style="list-style-type: none"> • OS2 Blue – AX105203 • OM1 Beige – AX105200 • OM2 Black – AX105201 • OM3/4 Aqua – AX105202 	12 or 24 brilliance connectors ST, 900 micron: <ul style="list-style-type: none"> • OS2 Blue – AX105213 • OM1 Beige – AX105210 • OM2 Black – AX105211 • OM3/4 Aqua – AX105212 	–

MIPP Copper Panel Accessories

Industrial Ethernet DataTuff Patch Cords

- Cat 5e 2 or 4 pairs
- Cat 6 4 pairs
- Cat 6A 4 pairs
- Shielded or Unshielded
- Twisted Pair, Quad or Bonded-Pair
- PVC, FRNC, TPE or PUR jackets



Section Table of Contents

Technical Information	Page
Belden Conductor Color Code Charts	344–345
Conductors	346–348
Insulations and Jackets	349–352
Shielding	353–355
Cables Standards Reference Guide	356
Cables Substitution Chart	357
Canadian Substitution Hierarchy and Catalog Terms of Use	358
Glossary	359–363

Belden Conductor Color Code Charts

Color Code Chart 1

Cond. No.	Color
1	Black
2	White
3	Red
4	Green
5	Brown
6	Blue
7	Orange
8	Yellow
9	Purple
10	Gray
11	Pink
12	Tan

Color Code Chart 2 and 2R: 2 = Spiral Stripe, 2R = Ring Band Stripe

Cond. No.	Color
1	Black
2	White
3	Red
4	Green
5	Orange
6	Blue
7	White/Black Stripe
8	Red/Black Stripe
9	Green/Black Stripe
10	Orange/Black Stripe
11	Blue/Black Stripe
12	Black/White Stripe
13	Red/White Stripe

Cond. No.	Color
14	Green/White Stripe
15	Blue/White Stripe
16	Black/Red Stripe
17	White/Red Stripe
18	Orange/Red Stripe
19	Blue/Red Stripe
20	Red/Green Stripe
21	Orange/Green Stripe
22	Black/White/Red
23	White/Black/Red
24	Red/Black/White
25	Green/Black/White
26	Orange/Black/White

Cond. No.	Color
27	Blue/Black/White
28	Black/Red/Green
29	White/Red/Green
30	Red/Black/Green
31	Green/Black/Orange
32	Orange/Black/Green
33	Blue/White/Orange
34	Black/White/Orange
35	White/Red/Orange
36	Orange/White/Blue
37	White/Red/Blue
38	Black/White/Green
39	White/Black/Green

Cond. No.	Color
40	Red/White/Green
41	Green/White/Blue
42	Orange/Red/Green
43	Blue/Red/Green
44	Black/White/Blue
45	White/Black/Blue
46	Red/White/Blue
47	Green/Orange/Red
48	Orange/Red/Blue
49	Blue/Orange/Red
50	Black/Orange/Red

Color Code Chart 3: Belden Standard for Paired Cable

Pair	Color
1	Black & Red
2	Black & White
3	Black & Green
4	Black & Blue
5	Black & Yellow
6	Black & Brown
7	Black & Orange
8	Red & White
9	Red & Green
10	Red & Blue

Pair	Color
11	Red & Yellow
12	Red & Brown
13	Red & Orange
14	Green & White
15	Green & Blue
16	Green & Yellow
17	Green & Brown
18	Green & Orange
19	White & Blue
20	White & Yellow

Pair	Color
21	White & Brown
22	White & Orange
23	Blue & Yellow
24	Blue & Brown
25	Blue & Orange
26	Brown & Yellow
27	Brown & Orange
28	Orange & Yellow
29	Purple & Orange
30	Purple & Red

Pair	Color
31	Purple & White
32	Purple & Green
33	Purple & Blue
34	Purple & Yellow
35	Purple & Brown
36	Purple & Black
37	Gray & White

Color Code Chart 4: Belden Standard for Paired Cable

Pair	Color
1	White & Blue
2	White & Orange
3	White & Green
4	White & Brown
5	White & Gray
6	Red & Blue
7	Red & Orange

Pair	Color
8	Red & Green
9	Red & Brown
10	Red & Gray
11	Black & Blue
12	Black & Orange
13	Black & Green
14	Black & Brown

Pair	Color
15	Black & Gray
16	Yellow & Blue
17	Yellow & Orange
18	Yellow & Green
19	Yellow & Brown
20	Yellow & Gray
21	Purple & Blue

Pair	Color
22	Purple & Orange
23	Purple & Green
24	Purple & Brown
25	Purple & Gray

Color Code Chart 5: Western Electric Standard for Paired Cable

Pair	Color
1	White/Blue Stripe & Blue/White Stripe
2	White/Orange Stripe & Orange/White Stripe
3	White/Green Stripe & Green/White Stripe
4	White/Brown Stripe & Brown/White Stripe
5	White/Gray Stripe & Gray/White Stripe
6	Red/Blue Stripe & Blue/Red Stripe
7	Red/Orange Stripe & Orange/Red Stripe

Pair	Color
8	Red/Green Stripe & Green/Red Stripe
9	Red/Brown Stripe & Brown/Red Stripe
10	Red/Gray Stripe & Gray/Red Stripe
11	Black/Blue Stripe & Blue/Black Stripe
12	Black/Orange Stripe & Orange/Black Stripe
13	Black/Green Stripe & Green/Black Stripe
14	Black/Brown Stripe & Brown/Black Stripe

Pair	Color
15	Black/Gray Stripe & Gray/Black Stripe
16	Yellow/Blue Stripe & Blue/Yellow Stripe
17	Yellow/Orange Stripe & Orange/Yellow Stripe
18	Yellow/Green Stripe & Green/Yellow Stripe
19	Yellow/Brown Stripe & Brown/Yellow Stripe
20	Yellow/Gray Stripe & Gray/Yellow Stripe
21	Purple/Blue Stripe & Blue/Purple Stripe

Pair	Color
22	Purple/Orange Stripe & Orange/Purple Stripe
23	Purple/Green Stripe & Green/Purple Stripe
24	Purple/Brown Stripe & Brown/Purple Stripe
25	Purple/Gray Stripe & Gray/Purple Stripe

Color Code Chart E1 ICEA S-73-532

Cond. No.	Base Color	Tracer	Tracer	Cond. No.	Base Color	Tracer	Tracer	Cond. No.	Base Color	Tracer	Tracer	Cond. No.	Base Color	Tracer	Tracer
1	Black	-	-	14	Green	White	-	27	Blue	Black	White	40	Red	White	Green
2	White	-	-	15	Blue	White	-	28	Black	Red	Green	41	Green	White	Blue
3	Red	-	-	16	Black	Red	-	29	White	Red	Green	42	Orange	Red	Green
4	Green	-	-	17	White	Red	-	30	Red	Black	Green	43	Blue	Red	Green
5	Orange	-	-	18	Orange	Red	-	31	Green	Black	Orange	44	Black	White	Blue
6	Blue	-	-	19	Blue	Red	-	32	Orange	Black	Green	45	White	Black	Blue
7	White	Black	-	20	Red	Green	-	33	Blue	White	Orange	46	Red	White	Blue
8	Red	Black	-	21	Orange	Green	-	34	Black	White	Orange	47	Green	Orange	Red
9	Green	Black	-	22	Black	White	Red	35	White	Red	Orange	48	Orange	Red	Blue
10	Orange	Black	-	23	White	Black	Red	36	Orange	White	Blue	49	Blue	Red	Orange
11	Blue	Black	-	24	Red	Black	White	37	White	Red	Blue	50	Black	Orange	Red
12	Black	White	-	25	Green	Black	White	38	Black	White	Green				
13	Red	White	-	26	Orange	Black	White	39	White	Black	Green				

Pair cables are Black, White, and Numbered.
Triad cables are Black, White, Red, and Numbered.

Color Code Chart E2 ICEA S-73-532

Cond. No.	Base Color	Tracer	Cond. No.	Base Color	Tracer	Cond. No.	Base Color	Tracer	Cond. No.	Base Color	Tracer
1	Black	-	11	Brown	Black	21	Brown	Blue	31	Brown	Yellow
2	Red	-	12	Black	Red	22	Black	Orange	32	Black	Brown
3	Blue	-	13	Blue	Red	23	Red	Orange	33	Red	Brown
4	Orange	-	14	Orange	Red	24	Blue	Orange	34	Blue	Brown
5	Yellow	-	15	Yellow	Red	25	Yellow	Orange	35	Orange	Brown
6	Brown	-	16	Brown	Red	26	Brown	Orange	36	Yellow	Brown
7	Red	Black	17	Black	Blue	27	Black	Yellow			
8	Blue	Black	18	Red	Blue	28	Red	Yellow			
9	Orange	Black	19	Orange	Blue	29	Blue	Yellow			
10	Yellow	Black	20	Yellow	Blue	30	Orange	Yellow			

Pair cables are Black, Red, and Numbered.
Triad cables are Black, Red, Blue and Numbered.
Colors repeat after 36 conductors.
There are no Green or White conductors or stripes.

**Color Code Chart M4
ICEA Method 4: All Conductors Black and Numbered ICEA S-73-532**

Cond. No.	Conductor Printing	Cond. No.	Conductor Printing	Cond. No.	Conductor Printing	Cond. No.	Conductor Printing
1	"1-ONE-1"	14	"14-FOURTEEN-14"	27	"27-TWENTY-SEVEN-27"	40	"40-FORTY-40"
2	"2-TWO-2"	15	"15-FIFTEEN-15"	28	"28-TWENTY-EIGHT-28"	41	"41-FORTY-ONE-41"
3	"3-THREE-3"	16	"16-SIXTEEN-16"	29	"29-TWENTY-NINE-29"	42	"42-FORTY-TWO-42"
4	"4-FOUR-4"	17	"17-SEVENTEEN-17"	30	"30-THIRTY-30"	43	"43-FORTY-THREE-43"
5	"5-FIVE-5"	18	"18-EIGHTEEN-18"	31	"31-THIRTY-ONE-31"	44	"44-FORTY-FOUR-44"
6	"6-SIX-6"	19	"19-NINETEEN-19"	32	"32-THIRTY-TWO-32"	45	"45-FORTY-FIVE-45"
7	"7-SEVEN-7"	20	"20-TWENTY-20"	33	"33-THIRTY-THREE-33"	46	"46-FORTY-SIX-46"
8	"8-EIGHT-8"	21	"21-TWENTY-ONE-21"	34	"34-THIRTY-FOUR-34"	47	"47-FORTY-SEVEN-47"
9	"9-NINE-9"	22	"22-TWENTY-TWO-22"	35	"35-THIRTY-FIVE-35"	48	"48-FORTY-EIGHT-48"
10	"10-TEN-10"	23	"23-TWENTY-THREE-23"	36	"36-THIRTY-SIX-36"	49	"49-FORTY-NINE-49"
11	"11-ELEVEN-11"	24	"24-TWENTY-FOUR-24"	37	"37-THIRTY-SEVEN-37"	50	"50-FIFTY-50"
12	"12-TWELVE-12"	25	"25-TWENTY-FIVE-25"	38	"38-THIRTY-EIGHT-38"		
13	"13-THRIRTEEN-13"	26	"26-TWENTY-SIX-26"	39	"39-THIRTY-NINE-39"		

Conductors

Solid Copper Wire, American Wire Gage

Gage (AWG)	Nominal OD		Nominal Circular MIL Area	Nominal Weight (Lbs. per 1000')	Nominal Resistance @ 68°F (Ω/1000')
	Inches	mm			
10	.1019	2.60	10,380.0	31.43	.9989
11	.0907	2.30	8234.0	24.92	1.260
12	.0808	2.05	6530.0	19.77	1.588
13	.0720	1.83	5178.0	15.68	2.003
14	.0641	1.63	4107.0	12.43	2.525
15	.0571	1.45	3260.0	9.858	3.184
16	.0508	1.29	2583.0	7.818	4.016
17	.0453	1.15	2050.0	6.200	5.064
18	.0403	1.02	1620.0	4.917	6.385
19	.0359	.912	1200.0	3.899	8.051
20	.0320	.813	1020.0	3.092	10.15
21	.0285	.724	812.1	2.452	12.80
22	.0253	.643	640.4	1.945	16.14
23	.0226	.574	511.5	1.542	20.36
24	.0201	.511	404.0	1.223	25.67
25	.0179	.455	320.4	.9699	32.37
26	.0159	.404	253.0	.7692	40.81
27	.0142	.361	201.5	.6100	51.47
28	.0126	.320	159.8	.4837	64.90
29	.0113	.287	126.7	.3836	81.83
30	.0100	.254	100.5	.3042	103.2
31	.0089	.226	79.7	.2413	130.1
32	.0080	.203	63.21	.1913	164.1
33	.0071	.180	50.13	.1517	206.9
34	.0063	.160	39.75	.1203	260.9
35	.0056	.142	31.52	.09542	331.0
36	.0050	.127	25.00	.07568	414.8
37	.0045	.114	19.83	.0613	512.1
38	.0040	.102	15.72	.04759	648.6
39	.0035	.089	12.20	.03774	847.8
40	.0031	.079	9.61	.02993	1080.0

Information from National Bureau of Standards Copper Wire Tables – Handbook 100.

Unparalleled Performance

Belden is one of only a very few cable manufacturers to draw and anneal its own conductors. This is a time-consuming process, but it allows us to ensure signal integrity, as well as proper physical characteristics.

In addition, the standards under which we design and manufacture our fiber optic cabling are among the strictest in the industry. The result is a comprehensive offering of products which give unparalleled performance and can satisfy your most demanding operating and environmental challenges.

Conductors
Stranded Copper Wire, American Wire Gage

Gage (AWG)	Stranding (Nom. AWG)	Min. Average OD of Strand	Approximate OD		ASTM Min. Circular MIL Area	Min. Weight (Lbs./1000')	Max. Resistance* @ 68°F (Ω/1000')
			Inch	mm			
36	7 x 44	.0019	.006	.152	25	.076	414.8
34	7 x 42	.0024	.0075	.191	39.7	.121	260.9
32	7 x 40	.0030	.0093	.236	64	.195	164.1
32	19 x 44	.0018	.010	.254	64	.195	164.1
30♦	7 x 38	.0038	.012	.305	100	.304	112.0
30	19 x 42	.0023	.012	.305	100	.304	112.0
28♦	7 x 36	.0048	.015	.381	159	.484	70.7
28♦	19 x 40	.0029	.016	.406	159	.484	70.7
27	7 x 35	.0054	.017	.432	202	.614	55.6
26♦	7 x 34	.0060	.019	.483	253	.770	44.4
26	10 x 36	.0050	.021	.533	253	.770	44.4
26♦	19 x 38	.0036	.020	.508	253	.770	44.4
24♦	7 x 32	.0076	.024	.610	404	1.229	27.7
24	10 x 34	.0064	.024	.610	404	1.229	27.7
24♦	19 x 36	.0046	.024	.610	404	1.229	27.7
24♦	42 x 40	.0031	.023	.584	404	1.229	27.7
22♦	7 x 30	.0096	.030	.762	640	1.947	17.5
22♦	19 x 34	.0058	.031	.787	640	1.947	17.5
22	26 x 36	.0050	.030	.762	640	1.947	17.5
20♦	7 x 28	.0126	.038	.965	1020	3.103	10.9
20	10 x 30	.0101	.037	.940	1020	3.103	10.9
20♦	19 x 32	.0073	.037	.940	1020	3.103	10.9
20	26 x 34	.0063	.036	.914	1020	3.103	10.9
20♦	42 x 36	.0049	.038	.965	1020	3.103	10.9
18♦	7 x 26	.0152	.048	1.22	1620	4.93	6.92
18	16 x 30	.0101	.047	1.19	1620	4.93	6.92
18♦	19 x 30	.0092	.049	1.24	1620	4.93	6.92
18♦	42 x 34	.0062	.047	1.19	1620	4.93	6.92
18♦	65 x 36	.0050	.047	1.19	1620	4.93	6.92
16♦	7 x 24	.0192	.060	1.52	2580	7.85	4.35
16♦	19 x 29	.0117	.058	1.47	2580	7.85	4.35
16	26 x 30	.0100	.059	1.50	2580	7.85	4.35
16♦	65 x 34	.0063	.059	1.50	2580	7.85	4.35
16	105 x 36	.0050	.059	1.50	2580	7.85	4.35
14♦	7 x 22	.0242	.076	1.93	4110	12.50	2.73
14♦	19 x 26	.0147	.071	1.80	4110	12.50	2.73
14♦	42 x 30	.0099	.075	1.91	4110	12.50	2.73
14	105 x 34	.0063	.075	1.91	4110	12.50	2.73
12♦	7 x 20	.0305	.096	2.44	6530	19.86	1.71
12♦	19 x 25	.0185	.093	2.36	6530	19.86	1.71
12♦	65 x 30	.0100	.095	2.41	6530	19.86	1.71
12	165 x 34	.0063	.095	2.41	6530	19.86	1.71
10	37 x 26	.0167	.115	2.92	10380	31.58	1.08
10	65 x 28	.0126	.120	3.05	10380	31.58	1.08
10	105 x 30	.0099	.118	3.00	10380	31.58	1.08

* AWG 10 through 30 per UL Subject 13.

Belden has standardized on the stranded conductors used in the design of all Belden products. These preferred constructions, based on standard industry practices, are marked with a ♦ symbol.

Conductors

Metric/Imperial/AWG Equivalentents (Square Millimeters/Square Inches/Circular Mills/AWG)

Sq. mm	Sq. In.	Cir. Mills	AWG
1000	1.550	1974000	
975	1.511	1924700	
950	1.472	1875300	
925	1.434	1826000	
900	1.395	1776600	
875	1.356	1727300	
850	1.317	1677900	
825	1.279	1628600	
800	1.240	1579200	
775	1.201	1529900	
750	1.163	1480500	
725	1.124	1431200	
700	1.085	1381800	
675	1.046	1332500	
650	1.008	1283100	
625	.969	1233800	
600	.930	1184400	
575	.891	1135100	
550	.853	1085700	
525	.814	1036400	
500	.775	987000	
475	.736	937700	
450	.698	888300	
425	.659	839000	
400	.620	789600	
375	.581	740300	
350	.542	690900	
325	.504	641600	
300	.465	592200	
275	.426	542900	
250	.388	493500	
225	.349	444200	
200	.310	394800	
175	.271	345500	
150	.233	296100	
125	.1938	246800	
-	-	211600	4/0
100	.1550	197400	
95	.1472	187530	
90	.1395	177660	
-	-	167800	3/0
85	.1317	167790	
80	.1240	157920	

Sq. mm	Sq. In.	Cir. Mills	AWG
75	.1163	148050	
70	.1085	138180	
-	-	133100	2/0
65	.1008	128310	
60	.0930	118440	
55	.0853	108570	
-	-	105600	1/0
50	.0775	98700	
45	.0698	88830	
-	-	83690	1
40	.0620	78960	
35	.0542	69090	
-	-	66360	2
30	.0465	59220	
-	-	52620	3
25	.0388	49350	
-	-	41740	4
20.0	.0310	39480	
19.5	.0302	38490	
19.0	.0294	37510	
18.5	.0287	36520	
18.0	.0279	35530	
17.5	.0271	34550	
17.0	.0264	33560	
-	-	33090	5
16.5	.0256	32560	
16.0	.0248	31580	
15.5	.0240	30600	
15.0	.0233	29610	
14.5	.0225	28620	
14.0	.0217	27640	
13.5	.0209	26650	
-	-	26420	6
13.0	.0201	25660	
12.5	.0194	24680	
12.0	.0186	23690	
11.5	.0178	22700	
11.0	.0171	21710	
-	-	20820	7
10.5	.0163	20730	
10.0	.0155	19740	
9.5	.01472	18753	
9.0	.01395	17766	

Sq. mm	Sq. In.	Cir. Mills	AWG
8.5	.01317	16779	
-	-	16510	8
8.0	.01240	15792	
7.5	.01163	14805	
7.0	.01085	13818	
-	-	13090	9
6.5	.01008	12831	
6.0	.00930	11844	
5.5	.00853	10857	
-	-	10380	10
5.00	.00775	9870	
4.75	.00736	9377	
4.50	.00698	8883	
4.25	.00659	8390	
-	-	8230	11
4.00	.00620	7896	
3.75	.00581	7403	
3.50	.00542	6909	
-	-	6530	12
3.25	.00504	6416	
3.00	.00465	5922	
2.75	.00426	5429	
-	-	5180	13
2.50	.00388	4935	
2.25	.00349	4422	
-	-	4110	14
2.00	.00310	3948	
1.75	.00271	3455	
-	-	3260	15
1.50	.00233	2961	
-	-	2580	16
1.25	.00194	2468	
-	-	2050	17
1.00	.00155	1974	
.90	.00140	1777	
-	-	1620	18
.80	.00124	1579	
.75	.00116	1481	
.70	.00109	1382	
-	-	1290	19
.60	.00093	1184	
-	-	1029	20
.50	.000775	987	

To Convert	Multiply By
Inches to millimeters	25.4
Millimeters to inches	.03937

Insulations and Jackets

Overview

Insulations

Because we formulate our own insulations, they provide superior performance under a variety of hostile environmental conditions. Belden cables are available in UL Listed and CSA Approved insulation compounds.

Among the insulations we offer:

- Polyethylene
- Polyvinyl chloride (PVC)
- Polypropylene

Also available are:

- **Datalene®** – For computer and data transmission, Datalene is crush resistant, lightweight, and offers good performance characteristics over a wide range of temperatures.
- **FEP Insulated Plenum & High-Temperature Cables** – For data communications, instrumentation/control, and other commercial and industrial applications. Plenum cables eliminate the need for conduit and reduce installation time.

Jackets

Belden electronic cables are manufactured in a wide selection of jacketing materials.

- **Flamarrest®** – A Belden jacketing innovation, Flamarrest is a low-smoke, flame retardant compound that is five times more flexible than fluorocopolymer. Cables jacketed with Flamarrest are cost efficient and easy to install.

Also included in our wide selection of jacketing compounds are:

- Polyvinyl chloride
- Polyethylene
- Polyurethane
- FEP
- ETFE
- E-CTFE
- Neoprene
- EPDM
- CSPE
- Silicone rubber
- Natural rubber

Special compounds and variations of standard compounds are used as well.

Insulations and Jackets

Overview (continued)

Typical Characteristics of Popular Insulation and Jacketing Compounds

EPDM

EPDM (ethylene-propylene-diene elastomer) is a chemically cross-linked elastomer with excellent flexibility at high and low temperatures (+150°C to -55 °C). It has good insulation resistance and dielectric strength, as well as excellent abrasion resistance and mechanical properties. EPDM also has better cut-through resistance than Silicone rubber, which it replaces in some applications.

EPDM is compatible with most varnishes, but after the dip and bake cycle varnish tends to adhere to the insulation (because EPDM, unlike some rubber insulations, does not exude oils or waxes). As lead wires are pulled apart for termination, the varnish cracks, sometimes breaking the insulation.

To resolve this problem, a stearic solution is applied to the lead wire during the put-up process. This ensures that rigid varnish does not cause EPDM insulation to rupture when the wire is terminated.

Field evaluations by numerous users reveal that the coated EPDM has excellent varnish resistance at least equal to synthetic elastomers, cross-link polyethylene, or silicone glass braid in dip and bake systems.

Flamarrest®

Flamarrest is a plenum grade chloride-based jacketing material with low smoke and low flame spread properties. Cables jacketed with Flamarrest meet the ANSI/NFPA Standard 262-1985 (U L910), Plenum Cable Flame Test.

E-CTFE

Thermoplastic fluoropolymer material with excellent chemical resistance, electrical properties, thermal characteristics, and impact resistance. The temperature rating is -70 °C to +150 °C.

Neoprene

The temperature range of this material can vary from -55 °C to +90 °C. The actual range would depend on the formulation used. Neoprene is both oil-resistant and sunlight-resistant, making it ideal for many outdoor applications. The most stable colors are

black, dark brown, and gray. The electrical properties are not as good as other insulation materials. Because of this, thicker insulation should be used. Typical designs where this material is used are lead wire insulation and cable jackets.

Polyethylene (Solid and Foamed)

A very good insulation in terms of electrical properties. Low dielectric constant, a stable dielectric constant over all frequencies, very high insulation resistance. In terms of flexibility, polyethylene can be rated stiff to very hard, depending on molecular weight and density – low density being the most flexible, with high-density, high-molecular weight formulation being very hard. Moisture resistance is rated excellent. Black and specially formulated colored versions have excellent weather resistance. The dielectric constant is 2.3 for solid insulation and typically 1.64 for foam designs.

Flame retardant formulations are available with dielectric constants ranging from about 1.7 for foam flame retardant to 2.58 for solid flame retardant polyethylene.

Polypropylene (Solid and Foam)

Similar in electrical properties to polyethylene. This material is primarily used as an insulation material. Typically, it is harder than polyethylene. This makes it suitable for thin wall insulations. UL maximum temperature rating may be +60 °C, +80 °C or +105 °C. The dielectric constant is 2.25 for solid and typically 1.55 for foam designs.

Polyurethane

This material is used primarily as a cable jacket material. It has excellent oxidation, oil, and ozone resistance. Some formations also have good flame resistance. It is a hard material with excellent abrasion resistance. It has outstanding "memory" properties, making it an ideal jacket material for retractile cords.

PVC

Sometimes referred to as vinyl or polyvinyl-chloride. Extremely high or low temperature properties cannot be found in one formulation. Certain formulations may have -55 °C to +105 °C rating. Other common vinyls may

have -20 °C to +60 °C. There are many formulations for the variety of different applications. The many varieties of PVC also differ in pliability and electrical properties. The price range can vary accordingly. Typical dielectric constant values can vary from 3.5 to 6.5.

Rubber

The description of rubber normally includes natural rubber and SBR compounds. Both of these materials can be used for insulations and jackets. There are many formulations of these basic materials. Each formulation is for a specific application. Some formulations are suitable for -55 °C minimum, while others are suitable for +75 °C maximum.

Silicone

This is a very soft insulation which has a temperature range from -80 °C to +200 °C. It has excellent electrical properties plus ozone resistance, low moisture absorption, weather resistance, and radiation resistance. It typically has low mechanical strength and poor scuff resistance.

FEP/TFE

This material has excellent electrical properties, temperature range, and chemical resistance. It is not suitable where subjected to nuclear radiation and does not have good high voltage characteristics. FEP is extrudable in a manner similar to PVC and polyethylene. This means that long wire and cable lengths are available. TFE is extrudable in a hydraulic ram type process. Lengths are limited due to amount of material in the ram, thickness of the insulation, and preform size. TFE must be extruded over a silver- or nickel-coated wire. The nickel- and silver-coated designs are rated +260 °C and +200 °C maximum, respectively. The cost of FEP/TFE is approximately 8 to 10 times more per pound than PVC compounds.

ETFE

Fluorocopolymer thermoplastic material having excellent electrical properties, heat resistance, chemical resistance, toughness, radiation resistance, and flame resistance. The temperature rating is -65 °C to +150 °C.

Insulations and Jackets

Comparative Properties of Plastic Insulating and Jacketing Compounds

Properties	PVC	LDPE	Cellular Polyethylene	HDPE	Polypropylene	Cellular Polypropylene	PUR	Nylon	CPE	Flamarrest®
Oxidation Resistance	E	E	E	E	E	E	E	E	E	E
Heat Resistance	G-E	G	G	E	E	E	G	E	E	G-E
Oil Resistance	F	G-E	G	G-E	F	F	E	E	E	F
Low-Temperature Flexibility	P-G	E	E	E	P	P	G	G	E	P-G
Weather, Sun Resistance	G-E	E	E	E	E	E	G	E	E	G
Ozone Resistance	E	E	E	E	E	E	E	E	E	E
Abrasion Resistance	F-G	G	F	E	F-G	F-G	O	E	E-O	F-G
Electrical Properties	F-G	E	E	E	E	E	P	P	E	G
Flame Resistance	E	P	P	P	P	P	P	P	E	E
Nuclear Radiation Resistance	F	G-E	G	G-E	F	F	G	F-G	O	F
Water Resistance	F-G	E	E	E	E	E	P-G	P-F	O	F
Acid Resistance	G-E	G-E	G-E	E	E	E	F	P-F	E	G
Alkali Resistance	G-E	G-E	G-E	E	E	E	F	E	E	G
Aliphatic Hydrocarbons Resistance (Gasoline, Kerosene, etc.)	P	G-E	G	G-E	P-F	P	P-G	G	E	P
Aromatic Hydrocarbons Resistance (Benzol, Toluol, etc.)	P-F	P	P	P	P-F	P	P-G	G	G-E	P-F
Halogenated Hydrocarbons Resistance (Degreaser Solvents)	P-F	G	G	G	P	P	P-G	G	E	P-F
Alcohol Resistance	P-F	E	E	E	E	E	P-G	P	E	G
Underground Burial	P-G	G	N/A	E	N/A	N/A	G	P	E-O	P

These ratings are based on average performance of general purpose compounds. Any given property can usually be improved by the use of selective compounding.

Comparative Properties of Fluoropolymer and Rubber Insulating and Jacketing Compounds

Properties	Fluoropolymers					Rubber				
	FEP	ETFE	PTFE	PVDF/PVF	E-CTFE	Rubber	Neoprene	CSPE	EPDM	Silicone
Oxidation Resistance	O	E	O	O	O	F	G	E	E	E
Heat Resistance	O	E	O	O	O	F	G	E	E	O
Oil Resistance	O	E	E-O	E	O	P	G	G	P	F-G
Low-Temperature Flexibility	O	E	O	F	O	G	F-G	F	G-E	O
Weather, Sun Resistance	O	E	O	E-O	O	F	G	E	E	O
Ozone Resistance	E	E	O	E	E	P	G	E	E	O
Abrasion Resistance	E	E	O	E	E	E	G-E	G	G	P
Electrical Properties	E	E	E	G-E	E	G	P	G	E	G
Flame Resistance	O	G	E	E	E-O	P	G	G	P	F-G
Nuclear Radiation Resistance	P-G	E	P	E	E	F	F-G	E	G	E
Water Resistance	E	E	E	E	E	G	E	E	G-E	G-E
Acid Resistance	E	E	E	G-E	E	F-G	G	E	G-E	F-G
Alkali Resistance	E	E	E	E	E	F-G	G	E	G-E	F-G
Aliphatic Hydrocarbons Resistance (Gasoline, Kerosene, etc.)	E	E	E	E	E	P	G	F	P	P-F
Aromatic Hydrocarbons Resistance (Benzol, Toluol, etc.)	E	E	E	G-E	E	P	P-F	F	F	P
Halogenated Hydrocarbons Resistance (Degreaser Solvents)	E	E	E	G	E	P	P	P-F	P	P-G
Alcohol Resistance	E	E	E	E	E	G	F	G	P	G
Underground Burial	E	E	E	E	E	N/A	N/A	N/A	N/A	N/A

These ratings are based on average performance of general purpose compounds. Any given property can usually be improved by the use of selective compounding.

CPE = Chlorinated Polyethylene • HDPE = High-density Polyethylene • LDPE = Low-density Polyethylene • PUR = Polyurethane

Insulations and Jackets

Nominal Temperature Range for Various Insulating and Jacketing Compounds

Compound	Normal Low	Normal High	Special Low	Special High
CSPE	-20 °C	+90 °C	-40 °C	+105 °C
EPDM	-55 °C	+105 °C	-	+150 °C
Neoprene	-20 °C	+60 °C	-55 °C	+90 °C
Polyethylene (Solid and Foamed)	-60 °C	+80 °C	-	-
Polypropylene (Solid and Foamed)	-40 °C	+105 °C	-	-
Rubber	-30 °C	+60 °C	-55 °C	+75 °C
FEP	-70 °C	+200 °C	—	-
PVC	-20 °C	+80 °C	-55 °C	+105 °C
Silicone	-80 °C	+150 °C	-	+200 °C
E-CTFE	-70 °C	+150 °C	-	-
ETFE	-65 °C	+150 °C	-	-
PTFE	-70 °C	+260 °C	-	-
CPE	-35 °C	+90 °C	-45 °C	+105 °C
PVDF/PVF	-20 °C	+150 °C/+125 °C	-40 °C	+150 °C/+150 °C
Flamarrest®	-20 °C	+75 °C	-	-

Shielding Overview

Innovative Leadership

The evolution of technology maintains steady demand for sophisticated cable shielding. Belden meets that demand with innovative shielding and shield effectiveness testing methods to supply you with high quality, dependable cable.

With the creation of trademarked shield designs and patented test methods, Belden has earned a reputation for innovation and leadership that is unequaled in the wire and cable industry. In addition, Belden offers the broadest line of shielded multi-conductor, coaxial and flat cable in the industry.

Several unique Belden innovations are utilized across a wide range of shielding applications:

- **Beldfoil®** – The first aluminum/polyester foil developed for use as a cable shield. Provides 100% shield coverage for optimum protection.
- **Duofoil®** – Consists of an aluminum-poly-aluminum laminate wrapped around the cable's dielectric core. Provides 100% physical coverage, and improves shield reliability and flex life.

Belden also uses a number of innovative techniques to apply shielding to multi-conductor and paired cables:

- **"French Braid" Shields** – Belden's patented "French Braid" shield is a double spiral (double serve shield) with the two spirals tied together by one weave.

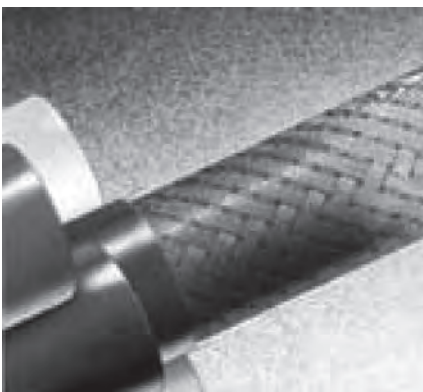

Belden's patented "French Braid" shield.

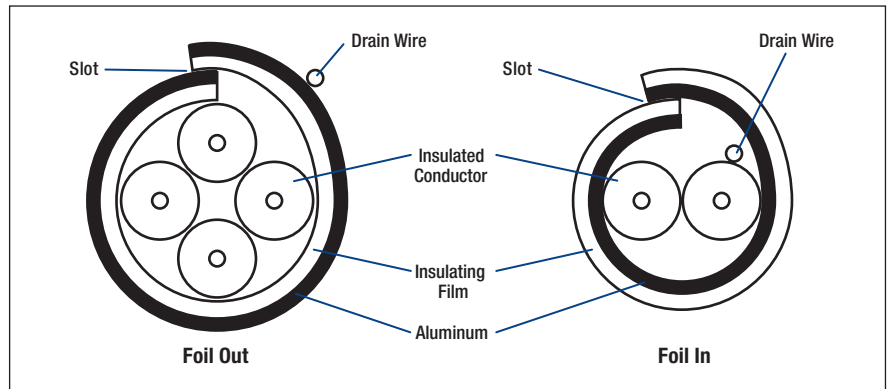

Figure 1: Foil shield configurations without shorting folds.

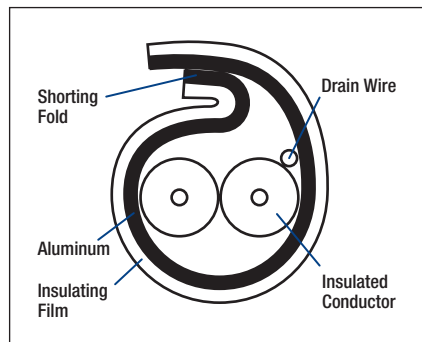

Figure 2: Foil shield configuration with shorting fold.

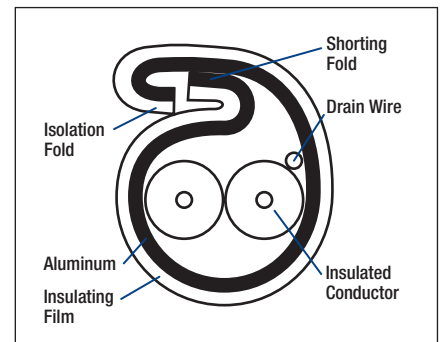

Figure 3: Foil shield with Z-Fold reduces crosstalk in multi-pair applications.

- **Shorting Fold** – Belden uses a shorting fold technique to maintain metal-to-metal contact for improved high frequency performance. Without the shorting fold, a slot is created through which signals can leak and cause interference. (See Figures 1 and 2.)

- **Z-Fold®** – Belden improves on the traditional shorting fold by employing a Z-Fold designed for use in multi-pair applications to reduce crosstalk. The Z-Fold (see Figure 3) combines an isolation and a shorting fold. The shorting fold provides metal-to-metal contact while the isolation fold keeps shields from shorting to one another in multi-pair, individually shielded cables.

The use of either a shorting fold or a Z-Fold increases the foil shield's range of effectiveness to higher frequencies.

Shielding

Characteristics of Belden Shield Types

Foil Shields

Foil shields consist of aluminum foil laminated to a polyester or polypropylene film. The film gives the shield mechanical strength and bonus insulation. Foil shields provide 100% cable coverage, necessary for electrostatic shield protection. Because of their small size, foil shields are commonly used to shield individual pairs of multi-pair data cables to reduce crosstalk. They have less weight, bulk and cost less than spiral or braid shields and are generally more effective than braid shields in RF ranges. Foil shields are more flexible than braid but have a shorter flex life than spiral or braid.



Drain wires are used with foil shields to make termination easier and to ground electrostatic discharges. The shortcomings in using the foil shield include higher DC resistance and lower mechanical strength than braid or spiral shields.

Braid Shields

A braid shield consists of groups of tinned or bare copper or aluminum strands, one set woven in a clockwise direction and interwoven with another set in a counterclockwise direction.

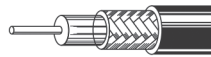

Braid shields provide superior structural integrity, while maintaining good flexibility and flex life. These shields are ideal for minimizing low frequency interference and have lower DC resistance than foil. Braid shields are effective at audio, as well as RF ranges.

Generally, the higher the braid coverage, the more effective the shield. However, the trade-off between cost and braid coverage must be considered. Typical braid coverages are between 80% and 95%. Coverage of 100% is unattainable with a braid shield. Other features to consider when choosing a braid shield are the weave angle, strand diameter, number of carriers (strand groups) and the number of ends (strands).

Braid shields are generally bulkier and heavier than other shields and, in some cases, harder to terminate because the braid may be combed out and pigtailed.

Spiral/Serve Shields

A spiral/serve shield consists of wire (usually copper) wrapped in a spiral around the inner cable core.



Superior flexibility and flex life, ease of termination and

up to 97% coverage are the advantages of spiral shields. They are best suited for audio applications. As a rule, spiral shields are not effective above the audio frequency range due to the coil effect produced by the inductance of served wire strands.

"French Braid" Shields

Belden's patented "French Braid" shield is a double spiral (double serve shield) with the two spirals tied together by one weave. This construction provides improved flex life over standard spiral shields, improved flexibility over conventional braid shields, and lower levels of microphonic or triboelectric noise than either spiral or conventional braid shields.



Combination Shields

Combination shields consist of more than one layer of shielding. They provide maximum shield efficiency across the frequency spectrum. The combination foil/braid shield combines the advantages of 100% foil coverage, plus the strength and low DC resistance of the braid.

Belden has also developed a number of shielding configurations for use with broadband coaxial cables.

- **Duobond®** – Duobond is essentially the same construction as Duofoil® (a laminated tape of foil/film/foil), but with an extra layer of adhesive bonding the foil shield to the dielectric core. This foil shield provides 100% coverage and insures maximum shield protection.

- **Duobond II (Foil/Braid)** – Combines Duobond with an outer braid, applied for greater protection against interference and to increase the overall tensile strength.

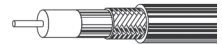

- **Duobond III (Tri-Shield)** – Uses the Duobond II design (foil/braid) plus a surrounding layer of Duofoil. The extra foil layer improves shield reliability and provides an additional interference barrier.



- **Duobond Plus®** – Features foil/braid/foil construction with a shorting fold in the outermost foil. This fold prevents a slot opening from being created in the shield, thereby preventing signal egress or ingress.



- **Duobond IV (Quad Shield)** – Offers an extra layer of braid shield (foil/braid/foil/braid) for improved strength and durability.



Other combination shields are available such as the foil/braid/foil/braid used on the Ethernet cables, braid/braid or foil/spiral.

Shielding

Shield Types Application Guide, Relative Cost Comparison of Shield Types Shield Performance Ratings

Shield Types Application Guide

Choose a Foil Shield...

- For protection against capacitive (electric field) coupling where shield coverage is more important than low DC resistance.
- When possible sources of interference include TV signals, crosstalk from other circuits, radio transmitters, fluorescent lights or computing equipment.
- For MATV, CATV, video, networking, computer I/O cables in office, industrial or commercial environments where ambient EMI levels are low.

Choose a Braid Shield...

- For superior performance against diffusion coupling, where low DC resistance is important, and to a lesser extent, capacitive and inductive coupling.
- When possible sources of interference exhibit low impedance characteristics, such as motor control circuits and switches which operate inductive loads.
- For computer to terminal interconnect for process, instrumentation or control applications.

Choose a Spiral Shield...

- For functional shielding against diffusion and capacitive coupling at audio frequencies only.
- When possible sources of interference are power lines and fluorescent lights.
- For applications when flexibility and flex life are major concerns, such as microphone and audio cables and retractile cords.

Choose a Combination Shield...

- For shielding against high frequency radiated emissions coupling and ESD. Combines the low resistance of braid and 100% coverage of foil shields.
- When possible sources of interference include radio transmitters, TV stations, printed circuit boards, back planes, motor control circuits and computing equipment.
- For Video, CATV, MATV, networking, computer I/O cables and computer-aided manufacturing applications.

Relative Cost Comparison

Relative cost comparisons are based on coaxial cable. Chart shows relative shield cost as one component of the total cost of the cable. These cost ratings may change depending on the physical construction of the cable.

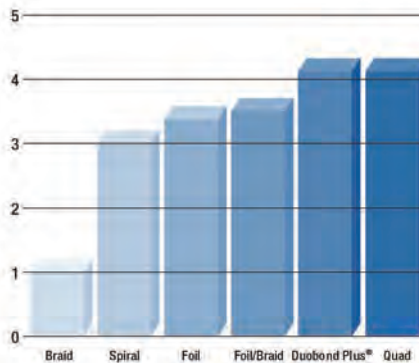

Shield Performance Comparison Chart

Frequency Range and Types of Interference Anticipated	Cable Shield Rating [®]				
	Braid 95% Coverage	Spiral	Foil	Foil/Braid	Foil/Braid/Foil Duobond Plus [®]
Frequency: DC					
Capacitive	A	AA	AAA	AAA	AAA
Diffusion	AAA	A	C	AAA	AAA
Diffusion/Inductive	–	–	–	–	–
Diffusion/Inductive/Capacitive	–	–	–	–	–
Frequency: 15 kHz					
Capacitive	A	AA	AAA	AAA	AAA
Diffusion	AAA	B	C	AAA	AAA
Diffusion/Inductive	AA	C	A	AA	AAA
Diffusion/Inductive/Capacitive	–	–	–	–	–
Frequency: 10 MHz to 1000 MHz					
Capacitive	A	AA	AAA	AAA	AAA
Diffusion	–	–	–	–	–
Diffusion/Inductive	B	C	A	AA	AAA
Diffusion/Inductive/Capacitive	B	C	A	AA	AAA

* Although ratings shown above are based on shielded coaxial cable test results, these ratings also pertain to shielded multi-conductor and flat cable where shield types are available.

Note: Shield effectiveness decreases as frequency increases. Therefore, ratings in one frequency category do not imply equal shield effectiveness in other frequency categories.

Shield Rating Key	
AAA	Best
AA	Better
A	Good
B	Functional
C	Unsatisfactory
–	Not Applicable

Cables Standards Reference Guide

National Electrical Code (NEC)[®] Catalog Reference Information

The National Electrical Code is a set of guidelines describing procedures which minimize the hazards of electrical shock, fires, and explosions caused by electrical installation. The text of the NEC is contained in nine chapters, each chapter broken into individual articles.

NEC types are acronyms consisting of a prefix describing cable type (e.g. coax, CATV, fiber optic) and a suffix indicating the type of flame test it has passed and where it can be installed. Articles describing wire and cable products – including required cable markings – are listed in the chart to the right.

Impact of the NEC

Almost everyone involved with wire and cable is affected by the National Electrical Code. In particular, the following groups must incorporate NEC guidelines into their work: OEM engineers, wire and cable product engineers, distributors, installers, and architects.

Although NEC covers wire and cable installed in factories, office buildings, hotels, motels, apartment buildings, residences, and all cables which pass through any floor, wall, ceiling, or which travel in ducts, plenums, and other air handling spaces, each individual municipality, city, county, or state can decide whether or not they wish to adopt the NEC as law. Local authorities having jurisdiction enforce their own codes. They have the right to accept or refuse any installation in accordance with their own local laws. One of the organizations local inspectors rely on to test wire and cable is Underwriters Laboratories (UL).

Intended Uses of Appliance Wiring Materials (AWM)

In the past, AWM cable was incorrectly used to wire buildings – this was never its intended use.

AWM cable is intended for internal wiring of factory-assembled, listed appliances such as computers, business machines, ranges, washers, dryers, radios, and televisions.

In some cases, AWM cable may be used for external connection. In these situations, the user should be aware that AWM cable temperatures and voltage ratings may differ from NEC ratings.

NEC Article/Type	Description	Installation Type			
		Plenum	Riser	Commercial	Residential
CL2	Class 2 cables	CL2P	CL2R	CL2	CL2X*
CL3	Class 3 cables	CL3P	CL3R	CL3	CL2X*
725 PLTC	A stand-alone class. This is a power limited tray cable – a CL3-type cable which can be used outdoors, is sunlight- and moisture-resistant and must pass the Vertical Tray flame test.	(none)	(none)	PLTC	(none)
760 FPL	Power limited, fire protective signaling circuit cable	FPLP	FPLR	FPL	(none)
770	OFC Fiber cable also containing metallic conductors	OFCP	OFCR	OFCG, OFC	(none)
	OFN Fiber cable only containing optical fibers	OFNP	OFNR	OFNG, OFN	(none)
800 CM	Communications	CMP	CMR	CMG, CM	CMX*
820 CATV	Community antenna television and radio distribution system	CATVP	CATVR	CATV	CATVX**
830 BM	Network-powered broadband communications cable	BLP	BMR	BM	BLX

* Cable diameter must be less than 0.250".

** Cable diameter must be less than 0.375".

C(UL) Certifications

UL/NEC-Approved cables may also be C(UL)/CEC-Approved as communications cables meeting the requirements of the Bi-National Standard CSA C22.2 No. 214/UL 444 and Section 60 of the Canadian Electrical Code, Part I (CEC). The C(UL) cable designation (and its meaning) would be one of the following:

1. **CMP** – Cable meeting CSA FT6 or NFPA 262 (UL 910);
2. **CMR** – Cable meeting UL 1666;
3. **CMG** – Cable meeting CSA FT4 or FT4/IEEE 1202 type of flames exposure (without smoke measurements) in UL 1685;
4. **CM** – Cable meeting UL 1685 (without smoke measurement) (UL 1581, Sec. 1160) Vertical-Tray;
5. **CMX or CMUC** – Meeting UL 1581, Sec. 1080 (VW-1);
6. **CMH** – Cable meeting CSA FT1.

NOTE: The CSA flame tests are defined in CSA C22.2 No. 0.3 as follows:

FT1 Vertical Flame Test – per C.S.A. C22.2 No. 0.3-92 Para 4.11.1

A finished cable shall not propagate a flame or continue to burn for more than 1 minute after five 15-second applications of the test flame. There is an interval of 15 seconds between flame applications. The flame test shall be performed in accordance with Para 4.11.1 of Canadian Standards Association (CSA) Standard C22.2 No. 0.3. In addition, if more than 25% of the indicator flag is burned, the test cable fails.

FT4 Vertical Flame Test – Cables in Cable Trays per C.S.A. C22.2 No. 0.3-92 Para 4.11.4

The FT4 Vertical Flame Test – Cables in Cable Trays is similar to the UL-1685 Vertical Tray Flame Test, but is more severe. The FT4 test has its burner mounted at 20° from the horizontal with the burner ports facing up. The UL-1685 Vertical Tray has its burner at 0° from the horizontal. The FT4 samples must be larger than 13 mm (.512") in diameter.

If not, then the cable samples are grouped in units of at least three (3) to obtain a grouped overall diameter of 13mm. The UL-1581 Vertical Tray does not distinguish on cable size. The FT4 has a maximum char height of 1.5 m (59") measured from the lower edge of the burner face. The UL-1685 has a flame height allowable up to approximately 78" measured from the burner.

FT6 Horizontal Flame & Smoke Test – per C.S.A. C22.2 No. 0.3-92 Appendix B

Belden products passing the FT6 Horizontal Flame and Smoke Test are designated FT6 in the column where the trade number appears. This test is for cables which must pass a Horizontal Flame and Smoke Test in accordance with ANSI/NFPA Standard 262-1985 (UL-910). The maximum flame spread shall be 1.50 meters (4.92 ft.). The smoke density shall be 0.5 at peak optical density and 0.15 at maximum average optical density.

Cables Substitution Chart

Per 2005 NEC®

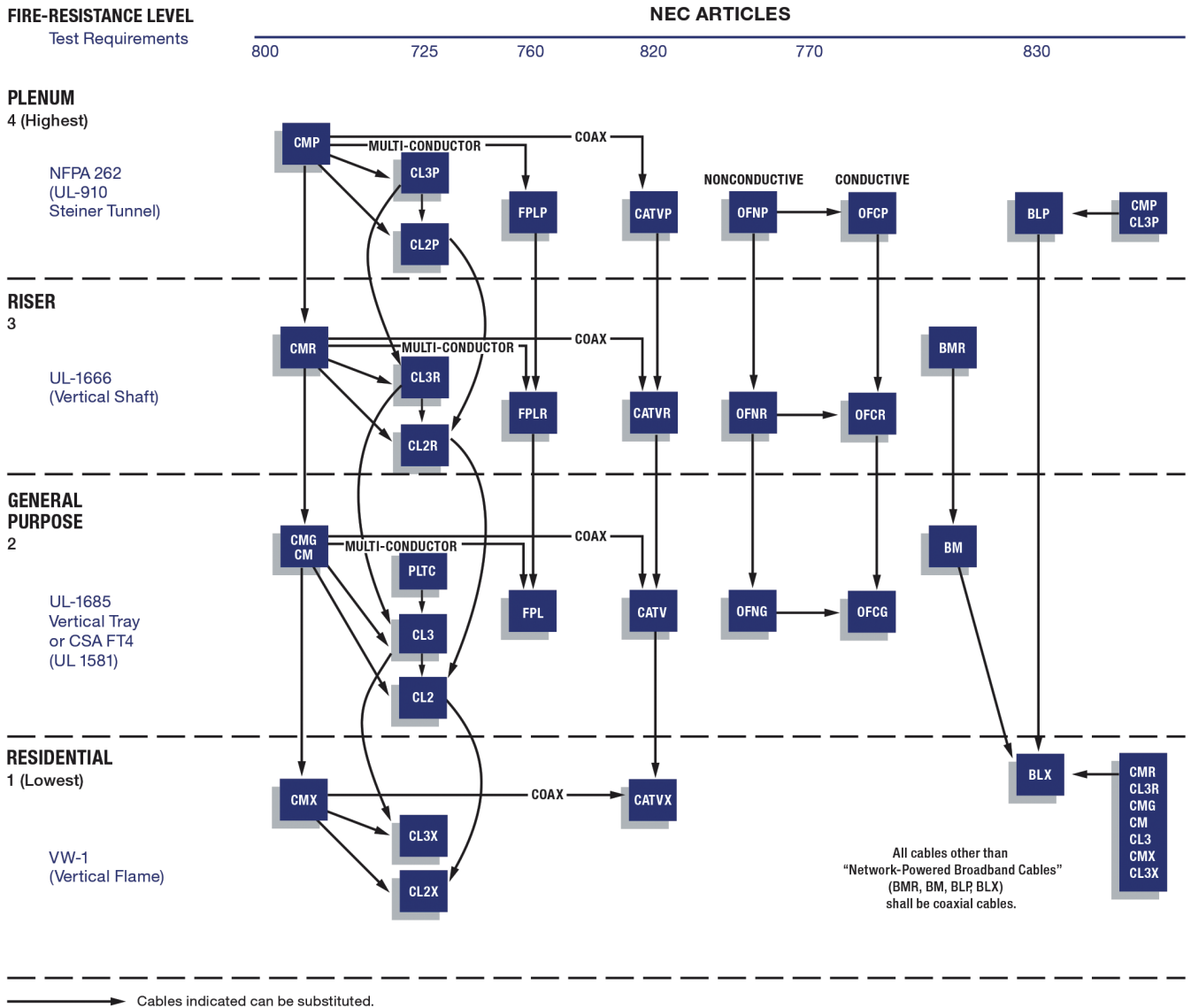

NEC Type	Definition
CMP, CMR, CMG, CM, CMX	Communications Cables
CL3P, CL3R, CL3, CL3X, CL2P, CL2R, CL2, CL2X	Class 2 and Class 3 Remote-Control, Signaling and Power Limited Cables
FPLP, FPLR, FPL	Power Limited Fire Alarm Cables
CATVP, CATVR, CATV, CATVX	Community Antenna Television and Radio Distribution Cables
OFNP, OFNR, OFNG, OFN	Nonconductive Optical Fiber Cables
OFCP, OFCR, OFCG, OFC	Conductive Optical Fiber Cables
PLTC	Power Limited Tray Cables
BMR, BM, BLP, BLX	Network-powered Broadband Communications Cable

National Electrical Code and NEC are registered trademarks of the National Fire Protection Association, Inc., Quincy, MA.

Canadian Substitution Hierarchy and Catalog Terms of Use

Cable Substitution Hierarchy as per C22.2 #214 – Communication Cables

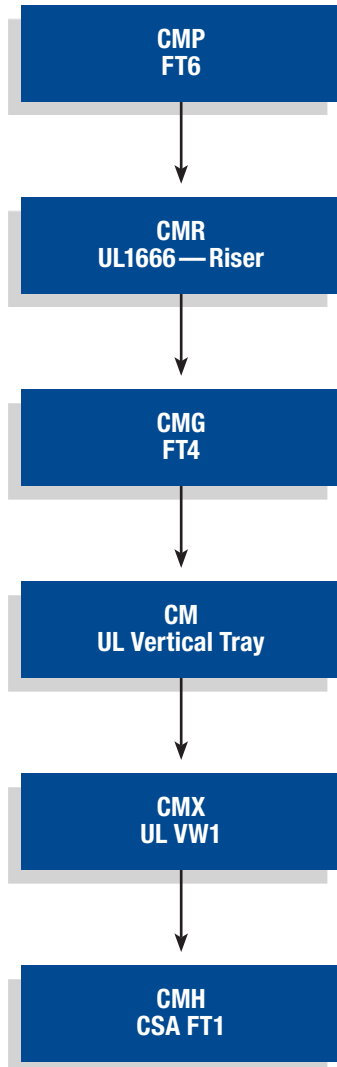

Canadian Electrical Code, Part 1, Table 19, Note 21:

The following cable substitution may be used:

- a. Communication cables marked CMP, CMR, CMG, CM, CMX, CMH, FT6, and FT4/IEEE 1202 have been found to meet the standard criteria for FT1.
- b. Communication cables marked CMP, CMR, CMG, and FT6 have been found to meet the standard criteria for FT4/IEEE 1202.
- c. Communication cables marked CMP have been found to meet the standard criteria for FT6.

Terms of Use

Use of Information; Disclaimers

Although Belden Electronics Division ("Belden") makes every reasonable effort to ensure their accuracy at the time of this publication, information and specifications described in this catalog are subject to change without notice. The most current product information may be found by accessing our Website at www.belden.com or contacting Belden Technical Support at 1-800-BELDEN1.

Belden provides the information and specifications in this catalog on an "AS IS" basis, with no representations or warranties, whether express, statutory or implied. WITH RESPECT TO SUCH INFORMATION AND SPECIFICATIONS, BELDEN DISCLAIMS ALL WARRANTIES OF MERCHANTABILITY, FITNESS FOR INTENDED PURPOSE AND NON-INFRINGEMENT. IT ALSO EXCLUDES ANY EXPRESS OR IMPLIED WARRANTIES ARISING FROM ANY COURSE OF DEALING, USAGE, TRADE PRACTICE OR PERFORMANCE. BELDEN'S SOLE WARRANTIES ARE AS BELDEN MAY PROVIDE IN (AND SUBJECT TO THE TERMS AND LIMITATIONS OF) SEPARATE WARRANTY DOCUMENTATION.

In no event will Belden be liable for any damages (including consequential, indirect, incidental, special, punitive, or exemplary damages) whatsoever, even if Belden has been advised of the possibility of such damages, whether in an action under contract, negligence or any other theory, arising out of or in connection with the use, inability to use, or performance of the information, specifications or products described in this catalog.

Belden's Terms and Conditions of Sale

All sales of Belden® products are subject to Belden's standard terms and conditions of sale.

Intellectual Property Protection

All trademarks or registered trademarks mentioned in this catalog are property of their respective owners. The information contained in this catalog is protected by copyright. No part of this catalog may be reproduced by any means without the prior written permission from Belden.

U.S. Export Laws

The United States Export Controls laws prohibit the export of certain technical data and software to certain territories. No content from this catalog may be reproduced or otherwise exported in violation of United States Law.

Glossary

Abrasion Resistance – Ability of a wire, cable or material to resist surface wear.

Accelerated Aging – A test that simulates long time environmental conditions in a relatively short time.

ACR – Attenuation to Crosstalk Ratio. The difference between attenuation and crosstalk, measured in dB, at a given frequency. Important characteristic in networking transmission to assure that signal sent down a twisted pair is stronger at the receiving end of the cable than are any interference signals imposed on that same pair by crosstalk from other pairs.

Alien Crosstalk – A measure of the unwanted signal coupling between cabling or components in close proximity.

American Wire Gage (AWG) – A standard for expressing wire diameter. As the AWG number gets smaller, the wire diameter gets larger.

Ampacity – Current handling capability expressed in amperes. The maximum current a conductor can carry without being heated beyond a safe limit.

Ampere – A standard unit of current. Defined as the amount of current that flows when one volt of electromotive force (EMF) is applied across one ohm of resistance. One ampere of current is produced by one coulomb of charge passing a point in one second.

Analog Signal – An electrical signal which varies continuously, not having discrete values. Analog signals are copies or representations of other waves in nature. An analog audio signal, for instance, is a representation of the pressure waves which make up audible sound.

Attenuation – The decrease in magnitude of a signal as it travels through any transmitting medium, such as a cable or circuitry. Attenuation is usually expressed logarithmically as the ratio of the original and decreased signal amplitudes. It is usually expressed in decibels (dB).

AWG – American Wire Gage. A wire diameter specification. The smaller the AWG number, the larger the wire diameter.

AWM – Appliance Wiring Material. A UL designation for a type of wire.

Balanced Line – A cable having two identical conductors which carry voltages opposite in polarity, but equal in magnitude with respect to ground, suitable for differential signal transmission.

Bandwidth – The difference between the upper and lower limits of a given band of frequencies. It is expressed in Hertz. The range of frequencies that a transmitted communications signal occupies or that a receiving system can accept. For example, it takes more bandwidth to download a photograph in a second than to download a page of text. Virtual reality and three-dimensional audio/visual presentations require even more.

Baud – Rate of digital transmission equal to the reciprocal of the time of one output signaling element.

Bel – A unit that represents the logarithm of the ratio of two levels. One bel equals the base 10 logarithm of the ratio of two power levels. It is also equal to the base 10 logarithm of square of the ratio of two voltage or current levels, provided the impedances are the same at the two levels. (See dB.)

Belflex® – A premium hybrid matte-finish jacket material that exhibits superior flexibility at low temperatures along with resistance compared to standard PVC jacketing materials.

Beldfoil® – Belden trademark for highly effective electrostatic shield of reinforced metallic foil.

Beldsol™ – Solderable Belden magnet wire combining insulating films of polyurethane for excellent dielectric characteristics and nylon for mechanical protection.

Bend Radius – Radius of curvature that a flat, round fiber optic or metallic cable can bend without any adverse effects.

Binder – A tape or thread used for holding assembled cable components in place.

Bit Error Rate – The number of errors occurring in a system per unit of time (e.g. bits per second).

Bonded Pairs™ – A patented method of providing uniform electrical characteristics in twisted pairs in which the insulations of the pair are bonded so that they maintain consistent geometry of twisting when bent or otherwise stressed during and after installation.

Braid – A group of textile or metallic filaments interwoven to form a tubular flexible structure which may be applied over one or more wires or flattened to form a strap.

Braid Angle – The angle between a strand of wire in a braid shield and the longitudinal axis (i.e., axis along the length of the center) of the cable it is wound around.

Breakdown Voltage – The voltage at which the insulation between two conductors will fail and allow electricity to conduct or “arc.”

Breakout – The point at which elements of a cable are separated from a multiconductor or fiber optic cable. Also called fanout.

Broadband – The technique used to multiplex multiple networks on a single cable without interfering with each other. Technologies that allow you to transmit or receive higher volumes of data at higher speeds.

Buffer – A protective coating over an optical fiber.

Bunch Strand – Conductors twisted together with the same lay and direction without regard to geometric pattern.

Buried – Cables that are required to go underground.

Bus-bar Wire – Uninsulated tinned copper wire used as a common lead.

Butyl Rubber – A synthetic rubber with good electrical insulating properties.

Cable – A group of electrically or optically conductive subcomponents twisted helically.

Cabling – The grouping or twisting together of two or more insulated conductors or subcomponents to form a cable.

Glossary (continued)

Capacitance – The ability of a dielectric material between conductors to store energy when a difference of potential exists between the conductors. The unit of measurement is the farad. Cable capacitance is usually measured in picofarads (pF).

Capacitive Crosstalk – Cable crosstalk or interference resulting from the coupling of the electrostatic field of one conductor upon one or more others.

Capacitive Reactance – The opposition to alternating current due to the capacitance of a capacitor, cable or circuit. It is measured in ohms and is equal to $1/(2\pi fC)$ where pi is approximately 3.1416, f is the frequency in Hz and C is the capacitance in farads.

Capacitor – Two conducting surfaces separated by a dielectric material. The capacitance is determined by the area of the surfaces, type of dielectric and spacing between the conducting surfaces.

Cellular Polyethylene – Expanded or “foam” polyethylene, consists of individual closed cells of inert gas suspended in a polyethylene medium. The result is a desirable reduction of the dielectric constant compared to solid polyethylene, which decreases attenuation and increases the velocity of propagation.

Center-to-Center Distance – Also called pitch. Nominal distance from center-to-center of adjacent conductors within a cable. When conductors are flat, pitch is usually measured from the reference edge of a conductor to the reference edge of the adjacent conductor.

Characteristic Impedance – In a transmission cable of infinite length, the ratio of the applied voltage to the resultant current at the point the voltage is applied. Or the impedance which makes a transmission cable seem infinitely long, when connected across the cable’s output terminals.

Circular Mil – Area of a wire that is one-thousandth of an inch (.001 inch, one mil) in diameter. This area is $\pi/4$ of a square mil. The circular mil area (CMA, cmil) equals the diameter in mils squared. By knowing the CMA of various conductors, they can be used to determine what conductivity and gage size various combinations will produce.

Cladding – A low refractive index material that surrounds the core of an optical fiber causing the transmitted light to travel down the core and protects against surface contaminant scattering or a layer of metal applied over another. Cladding is often chosen to improve conductivity or to resist corrosion.

Coaxial Cable – A cylindrical transmission line composed of a conductor centered inside a metallic tube or shield, separated by a dielectric material, and usually covered by an insulating jacket.

Coil Effect – The inductive effect exhibited by a spiral-wrapped shield, especially above audio frequencies.

Color Code – A system of different colors or stripes used to identify components of cables such as individual conductors or groups of conductors.

Composite Cable – Cable having conductors with two or more AWG sizes or more than one cable type.

Concentric Stranding – A group of uninsulated wires twisted together and containing a center core with subsequent layers spirally wrapped around the core with alternating lay directions to form a single conductor.

Conductivity – The ability of a material to allow electrons to flow, measured by the current per unit of voltage applied. It is the reciprocal of resistivity and is measured in siemens (S) or mhos.

Conductor – A substance, usually metal, used to transfer electrical energy from point to point.

Conduit – A tube of metal or plastic through which wire or cable can be run. Used to protect the wire or cable and, in the case of metal conduit, to contain the fire of a burning wire or cable.

Connector – A device designed to allow electrical flow from one wire or cable to a device on another cable. A connector will allow interruption of the circuit or the transfer to another circuit without any cutting of wire or cable or other preparation.

Cord – A very flexible insulated cable.

Core – The light conducting central portion of an optical fiber with a refractive index higher than that of the cladding. The center of a cable construction. Most often applies to a coaxial cable, where the core is the center conductor and the dielectric material applied to it.

Corona – The ionization of gasses about a conductor that results when the potential gradient reaches a certain value.

Coupling – The transfer of energy (without direct electrical contact) between two or more cables or components of a circuit.

Coverage – The extent to which a metal shield covers an underlying surface. Measured in percent.

CPE – Chlorinated polyethylene can be used as either a thermoplastic or thermoset. It is a tough chemical- and oil-resistant material and makes an excellent jacket for industrial control cable. As a thermoset, it can be used as an oil-resistant cord jacket. Other outstanding properties include low water absorption and superior crush resistance, which are important attributes in industrial control applications.

Crosstalk – A type of interference caused by signals from one pair or cable being coupled into adjacent pairs or cables. Can occur with audio, data or RF signals.

Datalene® – Belden trademark for foam polyolefin.

dB – Decibel

Decibel (dB) – A decibel is one-tenth of a bel and is equal to 10 times the logarithm of the power ratio, 20 times the log of the voltage ratio, or 20 times the log of the current ratio. Decibels are also used to express acoustic power, such as the apparent level of a sound. The decibel can express an actual level only when comparing with some definite reference level that is assumed to be zero dB.

Derating Factor – A multiplier used to reduce the current carrying capacity of conductors in more adverse environments, such as higher temperature, or where multiple conductors are together in one conduit.

Dielectric – An insulating (nonconducting) medium. It is the insulating material between conductors carrying a signal in a cable. In coaxial cables it is between the center conductor and the outer conductor. In twisted pair cables it is the insulation between conductors plus any surrounding air or other material.

Dielectric Breakdown – Any change in the properties of a dielectric that causes it to become conductive. Normally a catastrophic failure of an insulation because of excessive voltage. See Breakdown Voltage.

Dielectric Constant – Also called relative permittivity. That property of a dielectric which determines the amount of electrostatic energy that can be stored by the material when a given voltage is applied to it. Actually, the ratio of the capacitance of a capacitor using the dielectric to the capacitance of an identical capacitor using a vacuum (which has a dielectric constant of 1) as a dielectric. A number which indicates the quality of a material to resist holding an electrical charge when placed between two conductors.

Dielectric Heating – The heating of an insulating material when placed in a radio-frequency field, caused by internal losses during the rapid polarization reversal of molecules in the material.

Dielectric Loss – The power dissipated in a dielectric as the result of the friction produced by molecular motion when an alternating electric field is applied.

Dielectric Strength – The voltage an insulation can withstand before it breaks down. Usually expressed as volts per mil.

Dielectric Withstand Voltage – The voltage an insulation can withstand before it breaks down. Usually expressed as volts per mil.

Dispersion – The cause of bandwidth limitations in an optical fiber. Dispersion causes a broadening of input pulses along the length of the fiber. Two major types are (a) mode dispersion caused by differential optical path lengths in a multimode fiber, and (b) material dispersion caused by a differential delay of various wavelengths of light in a wave guide material.

Distortion – Any undesired change in a waveform or signal.

Drain Wire – A non-insulated wire in contact with parts of a cable, usually the shield, and used in the termination to that shield and as a ground connection.

Duobond® II – Belden trademark for a laminated shielding tape consisting of heat sensitive adhesive, aluminum foil, polyester or polypropylene and aluminum foil.

Duobond® IV – Belden trademark for a four-layer shield: (1) Duobond II foil, (2) tinned copper braid with 94% coverage, (3) Duofoil foil, (4) tinned copper braid with 90% coverage.

Duobond Plus® – Belden trademark for a foil/braid/foil connection with a shorting fold in the outermost shield.

Duofoil® – Belden trademark for a shield in which metallic foil is applied to both sides of a supporting plastic film.

Electromagnetic Coupling – The transfer of energy by means of a varying magnetic field. Inductive coupling.

Energy Dissipation – Loss of energy from a system due to the conversion of work energy into an undesirable form, usually heat. Dissipation of electrical energy occurs when current flows through a resistance.

EPDM – Ethylene-propylene-diene monomer rubber. A chemically cross-linked elastomer with good electrical insulating properties and excellent flexibility at high and low temperatures. It has good insulation resistance and dielectric strength, as well as excellent abrasion resistance and mechanical properties. EPDM has better cut-through resistance than silicone rubber, which it replaces in some applications.

Equilay – More than one layer of helically laid wires with the length of the lay in each layer.

Expanded Polyethylene – Expanded or "foam" polyethylene, consists of individual closed cells of inert gas suspended in a polyethylene medium, resulting in a desirable reduction of the dielectric constant.

Extruded Cable – Conductors are simultaneously insulated and the cable is formed by a continuous extrusion process.

FEP – Fluorinated ethylene-propylene. A thermoplastic material with good electrical insulating properties and chemical and heat resistance.

FEXT – Far End Crosstalk. Crosstalk induced on the pairs, measured at the far end of the cable, referenced to the near end input signal. Usually expressed in decibels (dB).

Fiber – A single, separate optical transmission element characterized by core and cladding.

Fiber Optics – Light transmission through optical fibers for communication and signaling. A technology that transmits information as light pulses along a glass or plastic fiber. Optical fiber carries much more information than conventional copper wire and is generally not subject to interference. Most telephone company long-distance lines are optical fiber.

Field – An area through which electric and/or magnetic lines of force pass.

Filled – Cables that are gel filled to improve waterblocking properties.

Fillers – Non-conducting components cabled with the insulated conductors or optical fibers to impart roundness and/or tensile strength to the cable.

Flamarrest® – Belden trademark for a plenum grade chloride-based thermoplastic jacketing material with low smoke and low flame spread properties; more flexible than traditional fluorocopolymer jacket materials. Cables jacketed with Flamarrest meet the ANSI/ NFPA Standard 2621-985 (UL-910) Flame Test.

Flame Resistance – The ability of a material to resist the spread of an applied flame.

Flex Life – The qualification of the number of times a cable may bend before breaking.

Flexibility – The ability of a cable to bend in a short radius. The ability of a cable to lay flat or conform to a surface as with microphone cables.

Glossary (continued)

Fluorocopolymer – Generic term for PVDF.

Foam Polyethylene – Expanded or “foam” polyethylene, consists of individual closed cells of inert gas suspended in a polyethylene medium, resulting in a desirable reduction of the dielectric constant.

FR-TPE – Flame retarded thermoplastic elastomer is a rubber-like plastic that has properties similar to rubber yet is processed as a thermoplastic. It is used as the insulation and jacket in an all TPE constructions which meets UL 13 and 1277 industrial cable requirements. It has good electrical properties, abrasion resistance, colorability, and flame retardance. This compound is ideal for cold weather applications.

Ground Conductor – A conductor in a transmission cable or line that is grounded.

Haloarrest® – Haloarrest is a non-halogenated flame retarding thermoplastic polyolefin with excellent low smoke and flame properties. It is often used as a jacket over the XLP insulated singles (non-XHHW), and the entire construction meets the UL 13 and 1277 specifications as a non-halogenated PLTC/TC cable. Haloarrest meets the European Specifications on acid gas evolution and % halogen content. This jacket can also be used with XHHW conductors for wet ratings.

HaloarrestXLink™ – HaloarrestXLink is a non-halogenated flame retarding thermoset compound with excellent low smoke and flame properties. The highly oil-resistant material is used as a jacket material in control, communication, and instrumentation applications and is suited for indoor and outdoor applications. The entire construction meets the UL 13 and 1277 specifications as a non-halogenated PLTC/TC cable. HaloarrestXLink meets the European Specifications on acid gas evolution and % halogen content.

Hook-Up Wire – Single conductor wire with various types of insulation.

Impedance Match – A condition whereby the impedance of a particular circuit, cable or component is the same as the impedance of the circuit, cable or device to which it is connected.

Impedance Matching Stub – A section of transmission line or pair of conductors cut to match the impedance of a load. Also called matching stub.

Insulation Stress – The molecule separation pressure caused by a potential difference across an insulator. The practical stress on insulation is expressed in volts per mil.

Interference – Disturbances of an electrical or electromagnetic nature that introduce undesirable responses into other electronic equipment.

Ionization – The formation of ions. Ions are produced when polar compounds are dissolved in a solvent and when a liquid, gas, or solid is caused to lose or gain electrons due to the passage of an electric current.

Ionization Voltage – The potential at which a material ionizes. The potential at which an atom gives up an electron.

Jacket – Pertaining to wire and cable, the outer protective covering that may also provide additional insulation.

Matte Finish PVC – A special formulation of PVC which very closely looks and feels like rubber. See Belflex®.

Mutual Capacitance – Effective capacitance between two conductors when the effects of the other conductors and shield, if present, are removed.

Neoprene – A synthetic rubber with good resistance to oil, chemical, and flame. Also called polychloroprene.

NEXT – Near-end Crosstalk. Crosstalk induced on the pairs, measured at the end near the transmitter. Usually expressed in decibels (dB).

NFPA – National Fire Protection Association.

Noise – In a cable or circuit, any extraneous signal which tends to interfere with the signal normally present in or passing through the system.

Non-Plenum – A description for a cable that does not meet the requirements of NFPA 262 (UL 910) CMP flame test. Such a cable cannot be installed in an area that is used for air return (plenum).

Nylon – An abrasion-resistant thermoplastic with good chemical resistance.

Ozone – Extremely reactive form of oxygen, normally occurring around electrical discharges and present in the atmosphere in small but active quantities. In sufficient concentrations it can break down certain rubber insulations under tension (such as a bent cable).

Plastic – High polymeric substances, including both natural and synthetic products that are capable of flowing under heat and pressure, called thermoplastics. Unlike rubber and other thermoset compounds, plastics can be remelted and reused.

Plasticizer – A chemical added to plastics to make them softer and more flexible.

Plenum – A compartment or chamber to which one or more air ducts are connected and that forms part of the air distribution system. A description for a cable that passes the NFPA 262 (UL-910) CMP flame test requirements.

Polyethylene (PE) – A thermoplastic material having excellent electrical properties. Low dielectric constant, a stable dielectric constant over all frequencies, very high insulation resistance. In terms of flexibility, polyethylene can be rated stiff to very hard, depending on molecular weight and density – low density being the most flexible and the high-density, high-molecular weight formulation being very hard. Moisture resistance is rated excellent.

Polymer – A substance made of many repeating chemical units or molecules. The term polymer is often used in place of plastic, rubber or elastomer.

Polyolefin – Any of the polymers and copolymers of the ethylene family of hydrocarbons, such as polyethylene and polypropylene.

Polypropylene (PP) – A thermoplastic similar to polyethylene but stiffer and having a higher softening point (temperature). This material is primarily used as an insulation material. Typically, it is harder than polyethylene. This makes it suitable for thin wall insulations. The dielectric constant is 2.25 for solid and 1.55 for cellular designs. Also called thermoplastic urethane (TPU).

Polyurethane (PUR or TPU) – Broad class of polymers noted for good abrasion and solvent resistance. Can be in solid or cellular form. This thermoplastic material is used primarily as a cable jacket material. It has excellent oxidation, oil, and ozone resistance. Some formulations also have good flame resistance. It is a hard material with excellent abrasion resistance. It has outstanding memory properties, making it an ideal jacket material for retractile cords.

Polyvinyl Chloride (PVC) – A general purpose thermoplastic used for wire and cable insulation and jackets.

Portable Cordage – Cable with two or more twisted conductors for flexible applications. Also called flexible cord.

PP – Polypropylene

Rated Temperature – The maximum temperature at which an electric component can operate for extended periods without loss of its basic properties.

Rated Voltage – The maximum voltage at which an electric component can operate for extended periods without undue degradation or safety hazard.

RG/U – RG is the abbreviation for radio guide, a military designation for a coaxial cable, and U stands for universal.

Rubber (Wire Insulation) – A general term used to describe wire insulations made of thermosetting elastomers, such as natural or synthetic rubbers, neoprene, butyl rubber and others.

Self-extinguishing – The characteristic of a material that extinguishes its own flame after the igniting flame is removed.

Separator – Pertaining to wire and cable, a layer of insulating material such as textile, paper, Mylar®, etc., which is placed between a conductor and its dielectric, between a cable jacket and the components it covers, or between various components of a multiple-conductor cable. It can be used to improve stripping qualities, flexibility or can offer additional mechanical or electrical protection to the components it separates.

Sheath – Pertaining to wire and cable, the outer protective covering, also called jacket, that may also provide additional insulation.

Shield – A tape, serve or braid (usually copper, aluminum or other conductive material) placed around or between electric circuits or cables or their components, to prevent signal leakage or interference.

Shield Coverage – The optical percentage of a cable actually covered by shielding material.

Shield Effectiveness – The relative ability of a shield to screen out undesirable interference or prevent signal leakage out of the cable. Frequently confused with the term shield coverage.

Shield Percentage – The percentage of physical area of a circuit or cable actually covered by shielding material.

Signal – Any visible or audible indication which can convey information. Also, the information conveyed through a communication system.

Silicone – A material made from silicon and oxygen. Can be in thermosetting elastomer or liquid form. The thermosetting elastomer form is noted for high heat resistance. This is a very soft thermoset insulation. It has excellent electrical properties plus ozone resistance, low moisture absorption, weather resistance, and radiation resistance. It typically has low mechanical strength and poor scuff resistance.

Single-mode Fiber – An optical fiber waveguide in which only one mode will propagate. The fiber has a very small core diameter of approximately 8 micro meters. It permits signal transmission at extremely high bandwidths and is generally used with laser diodes.

Thermoplastic – A material which will soften, flow or distort appreciably when subjected to sufficient heat and pressure. Examples are polyvinyl chloride and polyethylene.

Thermoset – A material which will not soften, flow or distort appreciably when subjected to heat and pressure. Vulcanizable. Examples are rubber and neoprene.

Triaxial Cable – A cable construction having a conductor and two isolated braid shields, all insulated from each other. A coaxial cable with a second braid applied over an inner jacket and an outer jacket applied over the outer braid. Commonly used in television camera systems.

Twinax Cable – Cable with two twisted conductors with established electrical properties (one pair = two conductors sharing a common axis = twinax).

Twisted Pair – Two lengths of insulated conductors twisted together. Gets its name because two insulated copper wires are twisted together, both of which are needed for each connection.

VW-1 – A flammability rating established by Underwriters Laboratories for wires and cables that pass a specially designed vertical flame test, formerly designed FR-1.

XLP – Cross-linked poly is a thermoset and is cross linked by radiation, thermally, or by moisture. XLP offers a wide range of operating temperatures, excellent deformation, abrasion, and flame resistance. XLP can be formulated with halogenated or non-halogenated flame retardant packages. Some grades are also rated XHHW-2 which offers excellent wet electrical properties.



Belden – Wire and Cable solutions for high quality, top performance and total reliability.

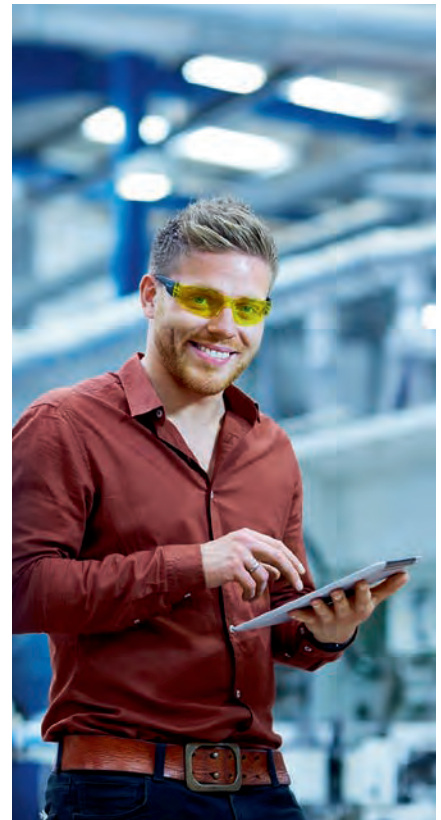



Part Number Index

Section Table of Contents

Part Number Index	
Part Number Index	366–392

Part Number Index

Part Number	Page	Part Number	Page	Part Number	Page
1000A	120	1089A	127	1481A	112
1006A	120	1090A	127	1484A	114
1012A	120	1091A	109	1485A	114
1013A	120	1092A	110	1486A	114
1018A	120	1093A	126	1489A	114
1023A	120	1094A	126	1490A	114
1030A	114	1095A	126	1492A	115
1031A	116	1096A	126	1493A	115
1032A	112	1097A	129	1494A	115
1033A	108	1098A	129	1495A	115
1034A	115	1099A	129	1498A	115
1035A	114	1100A	129	1499A	115
1036A	113	1101A	120	1503A	92
1037A	128	1118A	127	1504A	92
1038A	125	1119A	129	1508A	97
1039A	128	1120A	124	1526A	110
1040A	128	1121A	126	1527A	127
1041A	128	1211A	36	1528A	114
1042A	128	1212A	36	1529A	112
1043A	128	1213A	36	1883A	97
1044A	128	1214A	36	2109A	228
1045A	128	1242A	17	2110A	228
1046A	128	1266A	92	2111A	228
1047A	128	1268A	214	2112A	228
1048A	125	1269A	214	2113A	228
1049A	125	1327A	227	2114A	228
1050A	125	1328A	227	2115A	228
1051A	125	1329A	227	2116A	228
1052A	125	1330A	227	2117A	228
1053A	125	1331A	227	2118A	228
1054A	125	1332A	227	2119A	228
1055A	128	1333A	227	2120A	228
1056A	108	1334A	227	2121A	228
1057A	108	1335A	229	2122A	228
1058A	108	1336A	229	2123A	228
1059A	108	1345F	236	2124A	228
1060A	108	1346F	236	2125A	228
1061A	108	1348A	246	2126A	228
1062A	108	1349A	246	2127A	229
1063A	124	1359A	227	2128A	229
1064A	124	1360A	228	2129A	229
1065A	124	1361A	228	2130A	229
1066A	124	1362A	228	2131A	229
1067A	124	1363A	228	2132A	229
1068A	124	1364A	228	2133A	229
1069A	127	1365A	228	2134A	229
1070A	127	1366A	228	2135A	229
1071A	127	1367A	228	3000A	106
1072A	127	1419A	206	3001A	106
1073A	127	1420A	206	3002A	107
1074A	127	1421A	206	3003A	107
1075A	109	1422A	206	3004A	106
1076A	109	1423A	206	3005A	106
1077A	109	1424A	206	3006A	106
1078A	109	1425A	206	3007A	106
1079A	109	1466A	112	3008A	106
1080A	109	1467A	112	3009A	106
1081A	109	1468A	112	3010A	106
1082A	109	1471A	112	3011A	106
1083A	110	1472A	112	3012A	106
1084A	110	1474A	112	3013A	106
1085A	110	1475A	112	3014A	106
1086A	110	1476A	112	3015A	106
1087A	124	1477A	112	3016A	108
1088A	124	1480A	112	3017A	110

Part Number	Page	Part Number	Page	Part Number	Page
3018A	110	3085A	236	5320FME	33
3020A	110	3086A	237	5320UME	32
3021A	110	3087A	237	5322FME	33
3022A	110	3088A	124	5322UME	32
3023A	110	3088AE	125	5324FME	33
3024A	110	3088CE	125	5324UME	32
3025A	112	3089A	126	5326FME	33
3027A	113	3090A	127	5326UME	32
3028A	113	3090AE	128	6051	69
3029A	111	3090CE	128	6054	69
3030A	113	3091A	129	6059	69
3031A	113	3092A	243	6060	69
3032A	113	3092A	239	6163	71
3033A	113	3092F	239	6179	71
3034A	112	3092F	243	6193	71
3035A	112	3092F	240	7101W	42
3036A	113	3093A	239	7102W	42
3037A	113	3093A	243	7105W	42
3038A	113	3094A	240	7106W	42
3039A	113	3095A	240	7106WS	43
3041A	112	3102A	118	7107W	42
3042A	112	3103A	131	7108W	42
3043A	114	3104A	131	7110W	42
3044A	116	3105A	234	7111W	42
3045A	116	3106A	234	7111WS	43
3046A	116	3107A	234	7113W	42
3047A	116	3108A	234	7116W	42
3048A	116	3109A	234	7117W	42
3049A	116	3111A	120	7122W	42
3050A	114	3112A	120	7123WS	43
3051A	115	3113A	120	7125W	42
3052A	116	3115A	120	7126W	42
3053A	116	3118A	129	7127W	42
3054A	116	3119A	238	7129W	42
3055A	116	3120A	238	7129WS	43
3056A	114	3124A	238	7136WS	43
3057A	115	3125A	238	7145W	42
3064A	126	3126A	238	7200A	234
3067A	110	3130A	129	7200A	249
3068A	113	3131A	240	7201A	234
3069A	116	3132A	240	7201A	249
3072F	245	5000FME	34	7202A	234
3073F	245	5002FME	34	7202A	249
3074F	245	5020FME	34	7203A	234
3076ELS	227	5020UME	32	7203A	249
3076ELS	231	5022FME	34	7205A	249
3076ENH	227	5022UME	32	7206A	249
3076ENH	231	5100FME	34	7400W	44
3076F	231	5102FME	34	7401W	44
3076F	227	5120FME	34	7401WS	46
3077ELS	230	5120UME	32	7402W	44
3077ENH	230	5122FME	34	7403W	44
3077F	230	5122UME	32	7403WS	46
3078F	230	5200FME	33	7404W	44
3079A	232	5201FRE	35	7404WS	46
3079ALS	232	5202FME	33	7405W	44
3079ANH	232	5220FME	33	7406W	44
3079E	232	5220UME	32	7407W	44
3080A	130	5222FME	33	7408W	44
3081A	131	5222UME	32	7408WS	46
3082A	235	5240FRE	35	7409W	44
3082F	235	5300FME	33	7410W	44
3083A	236	5302FME	33	7410WS	46
3084A	236	5304FME	33	7411W	44
3084F	236	5306FME	33	7411WS	46

Part Number Index

Part Number	Page	Part Number	Page	Part Number	Page
7412W	44	7930A	263	8205NH	87
7413W	44	7931A	260	8302	209
7413WS	46	7932A	257	8303	209
7414W	44	7933A	257	8304	209
7415W	44	7934A	259	8305	209
7415WS	46	7935A	259	8306	209
7416W	44	7936A	259	8307	209
7416WS	46	7937A	259	8308	209
7417W	44	7938A	265	8310	209
7417WS	46	7939A	246	8312	209
7418W	44	7939A	263	8315	209
7421W	44	7940A	260	8318	209
7422W	44	7953A	246	8325	209
7422WS	46	7953A	260	8332	210
7423W	44	7957A	258	8333	210
7423WS	46	7958A	258	8334	210
7424W	44	7960A	266	8335	210
7425W	44	7961A	267	8336	210
7426W	44	7962A	268	8337	210
7427W	44	8000	179	8340	210
7427WS	46	8011	179	8342	210
7428W	44	8012	179	8345	210
7428WS	46	8013	179	8348	210
7429W	44	8019	179	8355	210
7429WS	46	8020	179	8434	85
7430W	44	8021	179	8442	18
7435W	45	8022	179	8443	18
7435WS	46	8023	179	8444	18
7436W	45	8024	179	8445	18
7438W	45	8025	179	8446	39
7438WS	46	8049	178	8448	39
7439W	45	8050	178	8450	91
7440W	45	8051	178	8451	91
7442W	45	8052	178	8452	191
7444W	45	8053	178	8453	193
7445W	45	8054	178	8454	194
7445WS	46	8055	178	8455	194
7447W	45	8056	178	8456	18
7447WS	46	8057	178	8457	18
7450WS	46	8058	178	8458	18
7453W	45	8073	178	8459	18
7500A	249	8074	178	8461	87
7501A	249	8075	178	8465	17
7502A	249	8076	178	8466	17
7503A	249	8077	178	8467	17
7504A	249	8078	178	8468	17
7701NH	244	8079	178	8469	17
7702NH	244	8080	178	8471	88
7703NH	244	8081	178	8471	244
7704NH	244	8083	178	8471LS	88
7895A	236	8085	178	8471LS	244
7896A	235	8132	212	8471NH	88
7897A	235	8132F0	206	8471NH	244
7900A	235	8133	212	8472	191
7918A	258	8134	212	8473	88
7919A	258	8134F0	206	8477	88
7921A	246	8135	212	8478	191
7921A	258	8135F0	206	8479	192
7922A	258	8138	212	8484	38
7923A	258	8138F0	206	8486	87
7924A	263	8142	212	8489	17
7927A	260	8142F0	206	8500	163
7928A	259	8148	212	8501	163
7929A	246	8155	212	8502	163
7929A	258	8205	87	8503	163

Part Number	Page	Part Number	Page	Part Number	Page
8504	163	8752	91	9159	87
8505	163	8757	89	9160	89
8520	163	8760	94	9161	87
8521	163	8760LS	94	9182	242
8522	163	8760NH	94	9182LS	242
8523	163	8761	91	9182NH	242
8524	163	8761NH	91	9184	96
8525	163	8762	94	9207	242
8527	163	8762NH	94	9207NH	242
8529	163	8763	86	9250	242
8530	163	8764	98	9260	20
8538	163	8766	98	9261	20
8597	163	8767	98	9271	242
8618	18	8768	98	9272	242
8619	17	8769	100	9302	96
8620	16	8770	18	9305	96
8621	16	8770NH	18	9306	96
8622	16	8771	18	9309	96
8623	16	8771NH	18	9312	118
8624	16	8772	18	9314	117
8627	16	8772NH	18	9315	96
8628	16	8773	100	9316	114
8629	16	8774	100	9318	111
8641	97	8775	100	9319	96
8643	20	8776	100	9320	108
8660	179	8777	100	9322	105
8661	179	8777	243	9327	96
8662	179	8777LS	100	9328	105
8663	179	8777LS	243	9329	105
8668	179	8777NH	100	9330	105
8669	179	8777NH	243	9331	105
8670	179	8777SB	100	9332	105
8673	38	8778	100	9333	105
8675	38	8778LS	100	9335	105
8677	38	8778NH	100	9341	124
8678	38	8786	28	9342	127
8690	87	8787	27	9343	130
8691	87	8788	28	9344	131
8692	87	8791	21	9363	107
8718	95	8794	17	9364	109
8719	95	8795	17	9365	113
8719NH	95	8800	164	9366	115
8720	95	8816	164	9367	117
8722	86	8824	164	9368	111
8723	99	8825	164	9369	111
8723LS	99	8866	177	9388	111
8723NH	99	8868	177	9389	111
8723SB	99	8869	177	9390	111
8724	85	8888	190	9391	111
8725	86	8890	177	9392	111
8728	85	8897	177	9402	103
8729	19	8898	177	9405	39
8730	85	8899	177	9406	99
8734	21	8908	162	9407	105
8735	20	8910	162	9408	108
8740	89	8915	162	9409	111
8741	89	8916	162	9410	114
8742	89	8917	162	9411	117
8743	89	8918	162	9412	118
8744	89	8919	162	9414	91
8747	90	8920	162	9418	19
8748	90	9154	94	9420	39
8749	90	9155	86	9420	194
8750	90	9156	87	9421	18
8751	96	9157	87	9422	39

Part Number Index

Part Number	Page	Part Number	Page	Part Number	Page
9422	194	9513	105	9621	16
9423	18	9514	105	9622	16
9424	39	9515	204	9623	16
9424	194	9516	105	9626	17
9425	39	9519	204	9637	201
9425	194	9520	105	9641	201
9427	39	9521	105	9680	206
9427	194	9524	105	9681	206
9429	39	9525	204	9682	206
9429	194	9526	105	9683	206
9430	18	9527	105	9684	206
9431	18	9531	164	9685	85
9432	18	9533	199	9696	214
9433	18	9534	199	9721	16
9434	18	9534NH	199	9728	207
9438	179	9535	199	9729	207
9439	17	9536	199	9729LS	207
9444	17	9536NH	199	9729NH	207
9445	17	9537	199	9730	207
9451	92	9538	199	9731	207
9451D	92	9539	199	9732	207
9451DP	93	9540	199	9734	207
9451P	93	9541	199	9735	207
9451SB	92	9541NH	199	9736	207
9455	17	9542	199	9737	207
9457	17	9543	199	9738	207
9460	94	9544	199	9740	87
9461	91	9545	199	9741	87
9462	91	9546	199	9742	87
9463	241	9550	204	9743	87
9463DB	241	9552	111	9744	90
9463F	241	9553	111	9745	90
9463LS	241	9554	111	9746	90
9463NH	241	9556	111	9747	90
9486	124	9559	111	9748	90
9487	127	9562	89	9750	87
9488	130	9563	111	9751	87
9489	131	9565	111	9752	87
9491	107	9566	89	9755	87
9492	109	9570	89	9767	100
9493	113	9571	29	9768	100
9494	115	9572	29	9769	100
9495	117	9574	30	9770	19
9498	17	9575	30	9772	27
9501	204	9576	29	9773	103
9501NH	204	9578	30	9774	103
9502	204	9579	30	9775	103
9502LS	204	9580	29	9776	103
9502NH	204	9581	30	9777	103
9503	204	9582	29	9794	17
9503NH	204	9583	30	9802	36
9504	204	9585	89	9803	36
9504NH	204	9608	200	9804	212
9505	204	9609	200	9805	212
9505NH	204	9610	200	9806	212
9506	204	9611	200	9807	212
9506NH	204	9612	200	9808	212
9507	204	9613	200	9809	212
9507NH	204	9614	200	9812	212
9508	204	9615	200	9813	212
9508NH	204	9616	200	9814	212
9509	204	9617	200	9819	212
9510	204	9618	200	9825	212
9510NH	204	9619	200	9829NH	210
9512	105	9620	16	9841	213

Part Number	Page	Part Number	Page	Part Number	Page
9841	233	9939	202	19204	191
9841LS	213	9940	202	19205	192
9841LS	233	9941	202	19206	192
9841NH	213	9942	202	19207	192
9841NH	233	9943	202	19208	192
9842	213	9944	202	19209	192
9842	233	9945	202	19216	194
9842LS	213	9946	202	19217	194
9842LS	233	9947	202	19227	191
9842NH	213	9948	202	19228	191
9842NH	233	9949	202	19229	192
9843	213	9950	202	19230	192
9843	233	9951	37	19348	192
9843NH	213	9952	37	19349	192
9843NH	233	9953	37	19350	193
9844	213	9954	37	19352	192
9844	233	9961	37	19353	192
9844LS	213	9962	37	19354	192
9844NH	213	9963	37	19362	193
9844NH	233	9964	37	19363	193
9855	214	9965	37	19364	193
9860	242	9966	37	19401	193
9867	177	9967	37	19402	193
9873	103	9968	37	19403	193
9874	103	9975	160	19404	190
9875	103	9976	160	19405	190
9876	103	9977	160	19500	191
9877	103	9978	160	19501	191
9879	103	9979	160	19502	191
9880	248	9980	160	19503	193
9883	103	9981	160	19504	193
9886	103	9982	160	19505	193
9890	36	9983	160	19506	191
9894	36	9984	160	19507	191
9899	177	9985	160	19508	191
9904	163	9986	160	21100	132
9906	163	9987	160	21101	132
9907	248	9989	161	21102	132
9908	162	9990	98	21103	132
9909	160	9991	98	21104	132
9910	162	9992	98	21105	132
9911	160	9993	98	21106	132
9912	162	9995	98	21107	132
9916	161	9998	193	21108	132
9917	160	11700A	258	21109	132
9918	161	11700A2	258	21110	132
9919	161	11872A	260	21111	132
9920	161	19105	192	21112	132
9921	161	19106	192	21113	132
9923	161	19107	192	21114	132
9924	162	19108	192	21115	132
9925	203	19109	192	21116	132
9926	161	19115	190	21117	132
9927	203	19120	191	21118	132
9928	161	19122	190	21119	132
9929	203	19123	190	21120	132
9930	161	19124	192	21121	132
9931	203	19125	192	21122	132
9932	203	19126	190	21123	132
9933	203	19129	192	21124	132
9934	203	19130	192	21125	132
9935	203	19140	191	21126	132
9936	203	19201	191	21127	132
9937	203	19202	191	21128	132
9938	203	19203	191	21129	132

Part Number Index

Part Number	Page	Part Number	Page	Part Number	Page
21130	132	21251	132	21348	62
21131	132	21252	132	21350	61
21132	132	21253	132	21351	61
21133	132	21254	132	21352	61
21134	132	21255	132	21353	61
21135	132	21256	132	21354	61
21136	132	21257	132	21355	61
21137	132	21258	132	21356	61
21138	132	21259	132	21357	61
21139	132	21260	132	21358	61
21140	132	21261	132	21359	61
21141	132	21262	132	21360	61
21142	132	21263	132	21361	61
21143	132	21264	132	21362	61
21144	132	21265	132	21363	61
21145	132	21266	132	21364	61
21146	132	21267	132	21365	61
21147	132	21300	61	21366	61
21148	132	21301	61	21367	61
21149	132	21302	61	21368	61
21150	132	21303	61	21369	61
21151	132	21304	61	21370	61
21152	132	21305	61	21371	61
21153	132	21306	61	21372	61
21154	132	21307	61	21373	61
21155	132	21308	61	21374	61
21212	132	21309	61	21375	61
21213	132	21310	61	21376	61
21214	132	21311	61	21377	61
21215	132	21312	61	21378	61
21216	132	21313	61	21379	61
21217	132	21314	61	21380	61
21218	132	21315	61	21381	61
21219	132	21316	61	21382	61
21220	132	21317	61	21383	61
21221	132	21318	61	21384	61
21222	132	21319	61	21385	61
21223	132	21320	61	21386	61
21224	132	21321	61	21387	61
21225	132	21322	61	21388	61
21226	132	21323	61	21389	62
21227	132	21324	61	21390	62
21228	132	21325	61	21391	62
21229	132	21326	61	21392	62
21230	132	21327	61	21393	62
21231	132	21328	61	21394	62
21232	132	21329	61	21395	62
21233	132	21330	61	21396	62
21234	132	21331	61	21397	62
21235	132	21332	61	21398	62
21236	132	21333	61	21400	61
21237	132	21334	61	21401	61
21238	132	21335	61	21402	61
21239	132	21336	61	21403	61
21240	132	21337	61	21404	61
21241	132	21338	61	21405	61
21242	132	21339	62	21406	61
21243	132	21340	62	21407	61
21244	132	21341	62	21408	61
21245	132	21342	62	21409	61
21246	132	21343	62	21410	61
21247	132	21344	62	21411	61
21248	132	21345	62	21412	61
21249	132	21346	62	21413	61
21250	132	21347	62	21414	61

Part Number	Page	Part Number	Page	Part Number	Page
21415	61	21501	61	21567	61
21416	61	21502	61	21568	61
21417	61	21503	61	21569	61
21418	61	21504	61	21570	61
21419	61	21505	61	21571	61
21420	61	21506	61	21572	61
21421	61	21507	61	21573	61
21422	61	21508	61	21574	61
21423	61	21509	61	21575	61
21424	61	21510	61	21576	61
21425	61	21511	61	21577	61
21426	61	21512	61	21578	61
21427	61	21513	61	21579	61
21428	61	21514	61	21580	61
21429	61	21515	61	21581	61
21430	61	21516	61	21582	61
21431	61	21517	61	21583	61
21432	61	21518	61	21584	61
21433	61	21519	61	21585	61
21434	61	21520	61	21586	61
21435	61	21521	61	21587	61
21436	61	21522	61	21588	61
21437	61	21523	61	21589	62
21438	61	21524	61	21590	62
21439	62	21525	61	21591	62
21440	62	21526	61	21592	62
21441	62	21527	61	21593	62
21442	62	21528	61	21594	62
21443	62	21529	61	21595	62
21444	62	21530	61	21596	62
21445	62	21531	61	21597	62
21446	62	21532	61	21598	62
21447	62	21533	61	21600	61
21448	62	21534	61	21601	61
21450	62	21535	61	21602	61
21451	62	21536	61	21603	61
21452	62	21537	61	21604	61
21453	62	21538	61	21605	61
21454	62	21539	62	21606	61
21455	62	21540	62	21607	61
21456	62	21541	62	21608	61
21457	62	21542	62	21609	61
21458	62	21543	62	21610	61
21459	62	21544	62	21611	61
21460	62	21545	62	21612	61
21461	62	21546	62	21613	61
21462	62	21547	62	21614	61
21463	62	21548	62	21615	61
21464	62	21550	61	21616	61
21465	62	21551	61	21617	61
21466	62	21552	61	21618	61
21467	62	21553	61	21619	61
21468	62	21554	61	21620	61
21469	62	21555	61	21621	61
21470	62	21556	61	21622	61
21471	62	21557	61	21623	61
21472	62	21558	61	21624	61
21473	62	21559	61	21625	61
21474	62	21560	61	21626	61
21475	62	21561	61	21627	61
21476	62	21562	61	21628	61
21477	62	21563	61	21629	61
21478	62	21564	61	21630	61
21479	62	21565	61	21631	61
21500	61	21566	61	21632	61

Part Number Index

Part Number	Page	Part Number	Page	Part Number	Page
21633	61	22019	133	22128	63
21634	61	22020	133	22130	63
21635	61	22021	133	22134	63
21636	61	22022	133	22138	63
21637	61	22023	133	22140	63
21638	61	22024	133	22141	63
21639	62	22025	133	22142	63
21640	62	22041	133	22143	63
21641	62	22042	133	22144	63
21642	62	22043	133	22145	63
21643	62	22044	133	22146	63
21644	62	22045	133	22147	63
21645	62	22046	133	22148	63
21646	62	22047	133	22150	63
21647	62	22048	133	22152	63
21648	62	22049	133	22154	63
21650	62	22050	133	22160	64
21651	62	22051	133	22161	64
21652	62	22052	133	22162	64
21653	62	22054	132	22170	64
21654	62	22055	132	22171	64
21655	62	22056	132	22180	64
21656	62	22057	132	22181	64
21657	62	22058	132	22603	135
21658	62	22059	132	22628	134
21659	62	22060	132	22629	134
21660	62	22061	132	22630	134
21661	62	22062	132	22631	134
21662	62	22063	132	22632	134
21663	62	22064	132	22633	134
21664	62	22065	132	22634	134
21665	62	22066	132	22635	134
21666	62	22067	132	22636	134
21667	62	22068	133	22637	134
21668	62	22069	133	22638	134
21669	62	22070	133	22639	134
21670	62	22071	133	22640	134
21671	62	22072	133	22641	134
21672	62	22073	133	22643	134
21673	62	22074	133	22645	134
21674	62	22075	133	22646	134
21675	62	22076	133	22647	134
21676	62	22077	133	22648	134
21677	62	22078	133	22654	134
21678	62	22079	133	22660	135
21679	62	22100	63	22662	135
22000	132	22101	63	22663	135
22001	132	22102	63	22670	134
22002	132	22103	63	22671	134
22003	132	22104	63	22672	135
22004	132	22105	63	22673	135
22005	132	22106	63	22674	135
22006	132	22107	63	22675	135
22007	132	22108	63	22676	134
22008	132	22110	63	22677	135
22009	132	22114	63	22678	135
22010	132	22118	63	22679	135
22011	132	22120	63	22680	135
22012	132	22121	63	22681	135
22013	132	22122	63	22682	135
22014	133	22123	63	22683	135
22015	133	22124	63	22684	135
22016	133	22125	63	22685	134
22017	133	22126	63	22686	134
22018	133	22127	63	22687	135

Part Number	Page	Part Number	Page	Part Number	Page
22688	135	24512	138	26535	136
22689	135	24513	138	26536	136
23500	136	24514	138	26537	136
23501	136	24515	138	26538	136
23503	136	24516	138	26539	137
23505	137	24517	138	26540	137
23506	136	24518	138	26541	137
23507	137	24519	138	26542	137
23508	137	24520	138	26543	137
23509	136	25500	138	26544	137
23510	136	25501	138	26545	137
23511	136	25502	138	26546	136
23512	137	25503	138	26547	137
23513	136	25504	138	26551	136
23514	136	25505	138	26553	137
23515	137	25506	138	26555	136
23516	137	25507	138	27080A	49
23519	136	25508	138	27109A	51
23520	137	25509	138	27138A	52
23521	136	25510	138	27243	55
23522	137	25511	138	27244	55
23523	137	25512	138	27245	55
23524	136	25513	138	27246	55
23525	136	25514	138	27247	55
23526	137	25517	138	27248	55
23527	136	25518	138	27249	55
23528	136	25519	138	27250	55
23529	137	25520	138	27251	55
23530	136	25522	138	27252	55
23531	136	25523	138	27253	55
23532	136	26500	136	27254	55
23533	136	26501	136	27255	55
23534	136	26502	137	27256	55
23536	137	26503	136	27257	56
23537	137	26504	136	27258	56
23538	136	26505	136	27259	56
23539	136	26506	136	27260	56
23541	137	26507	136	27261	56
23542	136	26508	136	27262	56
23543	136	26509	137	27263	56
23544	136	26510	137	27264	56
23545	137	26511	137	27265	56
23546	137	26512	137	27267	56
23547	137	26513	137	27268	56
23548	137	26514	136	27269	55
23549	137	26515	136	27270	55
23550	137	26516	136	27271	55
23554	136	26517	136	27272	55
23567	137	26518	136	27273	55
23568	136	26519	136	27274	55
23571	137	26520	136	27275	55
23575	136	26521	136	27276	55
23578	137	26522	137	27277	55
24500	138	26523	137	27278	55
24501	138	26524	137	27279	55
24502	138	26525	137	27280	55
24503	138	26526	137	27281	56
24504	138	26527	137	27282	56
24505	138	26528	137	27283	56
24506	138	26529	137	27284	56
24507	138	26530	136	27285	56
24508	138	26531	136	27286	56
24509	138	26532	136	27287	56
24510	138	26533	136	27288	56
24511	138	26534	136	27289	56

Part Number Index

Part Number	Page	Part Number	Page	Part Number	Page
27290	56	27882	59	28127A	51
27291	56	27883	59	28128A	51
27292	55	27884	59	28129A	51
27293	56	27885	58	28130A	51
27325A	48	27886	58	28131A	51
27325AS	48	27887	58	28132A	51
27337A	49	27888	59	28133A	51
27337AS	49	27889	59	28134A	51
27428	57	27890	60	28135A	51
27429	57	27891	60	28136A	51
27430	57	27892	60	28137A	51
27431	57	27893	60	28139A	52
27432	55	27894	59	28140A	52
27433	55	27895	59	28141A	52
27434	55	27896	59	28142A	52
27535	55	27916A	48	28143A	52
27538	55	27917A	49	28144A	52
27539	55	27969	55	28145A	52
27540	55	28081A	49	28146A	52
27541	56	28081AS	50	28147A	52
27636A	49	28082A	50	28148A	52
27641A	51	28082AS	50	28149A	52
27643A	52	28083A	50	28150A	52
27840	58	28084A	50	28151A	52
27841	58	28085A	50	28152A	52
27842	58	28086A	50	28153A	52
27843	58	28087A	50	28154A	52
27844	58	28088A	50	28155A	53
27845	58	28089A	50	28156A	53
27846	58	28090A	50	28157A	53
27847	58	28091A	50	28158A	53
27848	58	28092A	50	28159A	53
27849	58	28093A	50	28160A	53
27850	58	28094A	50	28161A	53
27851	58	28095A	50	28165A	53
27852	58	28096A	50	28166A	53
27853	58	28097A	50	28167A	53
27854	58	28098A	50	28168A	53
27855	58	28099A	50	28169A	53
27856	58	28100A	50	28170A	53
27857	58	28101A	50	28171A	53
27858	58	28102A	50	28172A	53
27859	58	28103A	50	28173A	53
27860	58	28104A	50	28174A	53
27861	58	28105A	50	28175A	53
27862	58	28106A	50	28176A	53
27863	58	28107A	50	28177A	53
27864	58	28108A	50	28178A	53
27865	58	28110A	51	28243	55
27866	59	28111A	51	28244	55
27867	59	28112A	51	28245	55
27868	59	28113A	51	28246	55
27869	59	28114A	51	28247	55
27870	59	28115A	51	28248	55
27871	59	28116A	51	28249	55
27872	59	28117A	51	28250	55
27873	59	28118A	51	28251	55
27874	59	28119A	51	28252	55
27875	59	28120A	51	28253	55
27876	59	28121A	51	28254	55
27877	59	28122A	51	28255	55
27878	59	28123A	51	28256	55
27879	59	28124A	51	28257	56
27880	59	28125A	51	28258	56
27881	59	28126A	51	28259	56

Part Number	Page	Part Number	Page	Part Number	Page
28260	56	28602A	48	28873	59
28261	56	28603A	48	28874	59
28262	56	28604A	48	28875	59
28263	56	28605A	48	28876	59
28264	56	28606A	48	28877	59
28265	56	28607A	48	28878	59
28267	56	28608A	48	28879	59
28268	56	28609A	48	28880	59
28269	55	28610A	48	28881	59
28270	55	28611A	48	28882	59
28271	55	28612A	48	28883	59
28272	55	28613A	48	28884	59
28273	55	28614A	48	28885	58
28274	55	28615A	49	28886	58
28275	55	28616A	49	28887	58
28276	55	28617A	49	28888	59
28277	55	28618A	49	28889	59
28278	55	28619A	49	28890	60
28279	55	28620A	49	28891	60
28280	55	28621A	49	28892	60
28281	56	28622A	49	28893	60
28282	56	28623A	49	28894	59
28283	56	28624A	49	28895	59
28284	56	28625A	49	28896	59
28285	56	28626A	49	28912A	50
28286	56	28627A	49	28969	55
28287	56	28628A	49	29004	66
28288	56	28629A	50	29005	66
28289	56	28630A	51	29006	66
28290	56	28632A	48	29007	66
28291	56	28633A	49	29008	66
28292	55	28634A	51	29009	66
28293	56	28840	58	29016	66
28323A	49	28841	58	29017	66
28324A	49	28842	58	29018	66
28326A	48	28843	58	29019	66
28326AS	48	28844	58	29020	66
28327A	48	28845	58	29021	66
28328A	48	28846	58	29022	66
28329A	48	28847	58	29023	66
28330A	49	28848	58	29024	66
28331A	49	28849	58	29025	66
28331AS	49	28850	58	29030	66
28334A	48	28851	58	29031	66
28334AS	48	28852	58	29032	66
28335A	48	28853	58	29033	66
28336A	48	28854	58	29034	66
28338A	49	28855	58	29035	66
28339A	49	28856	58	29036	66
28340A	49	28857	58	29038	66
28341A	49	28858	58	29040	66
28428	57	28859	58	29043	66
28429	57	28860	58	29048	66
28430	57	28861	58	29053	66
28431	57	28862	58	29058	66
28432	55	28863	58	29068	66
28433	55	28864	58	29078	66
28434	55	28865	58	29500	145
28535	55	28866	59	29500T	147
28538	55	28867	59	29500X	148
28539	55	28868	59	29501	145
28540	55	28869	59	29501T	147
28541	56	28870	59	29501X	148
28600A	48	28871	59	29502	145
28601A	48	28872	59	29502T	147

Part Number Index

Part Number	Page	Part Number	Page	Part Number	Page
29502X	148	30804	176	34410	172
29503	145	30806	176	34412	172
29503T	147	30808	176	34414	172
29503X	148	30810	176	34416	172
29504	145	30812	176	34418	172
29504T	147	30814	176	34430	172
29504X	148	30816	176	34440	172
29505	145	30818	176	34490	172
29505T	147	30820	176	34914	172
29505X	148	30830	176	34916	172
29506	145	30840	176	34918	172
29506T	147	30890	176	34920	172
29506X	148	31008N	171	34922	172
29507	145	31010	171	35410	171
29507T	147	31010N	171	35412	171
29507X	148	31012	171	35414	171
29510	145	31012N	171	35416	171
29511	145	31014	171	35418	171
29512	145	31014N	171	35420	171
29513	145	31502	174	35606	170
29528	145	31504	174	35608	170
29528T	147	31506	174	35610	170
29528X	148	31508	174	35612	170
29529	145	31510	174	35614	170
29529T	147	31512	174	35616	170
29529X	148	31514	174	35618	170
29530	145	31516	174	35620	170
29530T	147	31518	174	35622	170
29530X	148	31520	174	35716	170
29531	145	32410	176	35718	170
29531T	147	32412	176	35720	170
29531X	148	32414	176	35722	170
29532	145	32416	176	36100	173
29532T	147	32418	176	36101	173
29532X	148	32516	174	36102	173
29533	146	32518	174	36104	173
29534	146	32718	162	36106	173
29535	146	32720	162	36108	173
29536	146	32722	162	36140	173
29537	146	32820	161	36190	173
29538	146	32822	161	37100	168
29539	146	33302	175	37101	168
29540	146	33304	175	37102	168
29541	146	33306	175	37103	168
29542	146	33308	175	37104	168
29543	146	33310	175	37106	168
29544	146	33312	175	37108	168
29545	146	33314	175	37110	168
29546	146	33316	175	37112	168
29547	146	33318	175	37114	168
29550C	150	33320	175	37116	168
29551C	150	33322	175	37118	168
29552C	150	33390	175	37130	168
29553C	150	33414	175	37140	168
29554C	150	33416	175	37190	168
29555C	150	33418	175	37212	169
29556C	150	34017	177	37214	169
29557C	150	34020	177	37216	169
29558C	150	34400	172	37218	169
29559C	150	34401	172	37220	169
29560C	150	34402	172	37222	169
29561C	150	34403	172	37500	169
30800	176	34404	172	37501	169
30801	176	34406	172	37502	169
30802	176	34408	172	37504	169

Part Number	Page	Part Number	Page	Part Number	Page
37506	169	74002NH	263	83303E	26
37508	169	74002PU	263	83304E	26
37530	169	74003PU	265	83305E	26
37540	169	74004E	261	83306E	26
37590	169	74004NH	261	83307E	26
39110	165	74005E	264	83308E	26
39112	165	74005NH	264	83317E	26
39114	165	74005PU	264	83318E	26
39116	165	74009PU	265	83319E	26
39118	165	82418	19	83320E	26
39120	165	82418	22	83321E	26
39122	165	82442	22	83322E	26
39124	165	82442	88	83332E	26
39126	165	82444	22	83333E	26
39128	165	82489	22	83334E	26
70001E	231	82502	205	83335E	26
70001LS	231	82503	205	83336E	26
70001NH	231	82504	205	83337E	26
70006E	266	82505	205	83347E	26
70006NH	266	82506	205	83348E	26
70007E	267	82509	205	83349E	26
70007NH	267	82641	97	83350E	26
70007PU	267	82641	205	83351E	26
70008PU	268	82723	101	83352E	26
70009PU	268	82729	208	83393	25
70101E	232	82740	89	83394	25
70101LS	232	82741	88	83395	25
70101NH	232	82742	88	83396	25
70101PE	232	82743	88	83503	23
70102E	232	82757	88	83504	23
70103E	232	82760	94	83506	23
70105PU	232	82761	93	83509	23
70110E	231	82777	102	83512	23
70200E	231	82777	243	83515	23
70200LS	231	82778	102	83552	23
70200NH	231	82841	213	83553	23
70201E	153	82841	233	83554	23
70202E	153	82842	213	83556	23
70203E	153	82842	233	83559	23
70251PU	154	83000	166	83562	23
70252PU	154	83001	166	83569	23
70254PU	154	83002	166	83602	23
70256PU	154	83003	166	83604	23
70257PU	154	83004	166	83606	23
70258PU	154	83005	166	83609	23
70259PU	154	83006	166	83612	23
70260PU	155	83007	166	83652	23
70261PU	154	83008	166	83653	23
70262PU	154	83009	167	83654	23
70263PU	154	83010	167	83656	23
70264PU	154	83023	166	83659	23
70265PU	154	83025	166	83662	23
70266PU	155	83026	166	83702	23
70267PU	155	83027	166	83703	23
70268PU	154	83028	166	83704	23
70269PU	154	83029	166	83706	23
72001E	257	83030	166	83709	23
72001NH	257	83041	167	83712	23
72002E	262	83043	167	83715	23
72002NH	262	83045	167	83719	23
72002PU	262	83046	167	83752	31
74001E	258	83047	167	83753	31
74001NH	259	83048	167	83754	31
74001PU	259	83049	167	83756	31
74002E	263	83050	167	83802	31

Part Number Index

Part Number	Page	Part Number	Page	Part Number	Page
83803	31	89880	248	C5540	67
83804	31	89907	248	C5543	67
83806	31	121700A	258	C5548	67
83900	121	121700R	258	C5553	67
83905	121	121872A	260	C5558	67
83910	121	123092A	239	C5560	68
83915	121	123107A	234	C5561	68
83930	121	129463	241	C5562	68
83932	121	139463	241	C5563	68
83950	121	183076F	227	C5564	68
83951	121	183076F	231	C5565	68
83952	121	183079A	232	C5566	68
83953	121	183092A	239	C5568	68
83954	121	189463	241	C5570	68
83955	121	1229500	149	C5573	68
85102	24	1229501	149	C5578	68
85102	244	1229502	149	C5579	68
85103	24	1229503	149	C5580	68
85109	24	1229504	149	C5581	68
85164	97	1229505	149	C5582	68
85168	97	1229506	149	C5583	68
85220	24	1229507	149	C5590	70
85221	24	1229528	149	C5591	70
85230	25	1229529	149	C5592	70
85231	25	1229530	149	C5601	71
85240	25	1229531	149	C5602	71
85241	25	1229532	149	C5611	71
87723	101	1329500	149	C5621	71
87740	89	1329501	149	C5622	71
87760	94	1329502	149	C5625	71
87761	93	1329503	149	C5626	71
87777	102	1329504	149	C5701	70
87778	102	1329505	149	C5702	70
88442	22	1329506	149	C5730	70
88442	88	1329507	149	C5731	70
88444	22	1329528	149	C5732	70
88489	22	1329529	149	C5760	70
88641	97	1329530	149	C5761	70
88641	205	1329531	149	C5762	70
88723	101	1329532	149	C6064	67
88741	88	BE43769	277	CA00600	271
88757	88	BE43800	277	CA00613	272
88760	94	BE43802	277	CA00630	272
88761	93	C5500	67	CA00641	271
88770	22	C5501	67	CA00642	271
88777	102	C5502	67	CA00643	271
88778	102	C5503	67	CA00652	272
89182	242	C5504	67	CA00656	271
89418	22	C5505	67	CA00658	271
89463	241	C5506	67	CA00660	272
89503	205	C5508	67	CA00661	272
89504	205	C5510	67	CA00664	271
89505	205	C5513	67	CA00665	271
89696	214	C5518	67	CA00730	272
89728	208	C5523	67	CA00735	272
89729	208	C5528	67	E500001 010S1	274
89730	208	C5529	67	E500002 010S1	274
89731	208	C5530	67	E500003 010S1	274
89732	208	C5531	67	E500005 010S1	274
89740	89	C5532	67	E500025 010S1	274
89841	213	C5533	67	E501001 010S1	274
89841	233	C5534	67	E501002 010S1	274
89842	213	C5535	67	E501003 010S1	274
89842	233	C5536	67	E501005 010S1	274
89855	214	C5538	67	E502001 010S1	274

Part Number	Page	Part Number	Page	Part Number	Page
E502002 010S1	274	GAAD848	327	GBCD236	317
E502003 010S1	274	GAAD860	327	GBCD248	317
E502005 010S1	274	GAAD872	327	GBCD260	317
E502025 010S1	274	GAADD12	327	GBCD272	317
E503001 010S1	274	GAADD24	327	GBCD712	317
E503002 010S1	274	GAADD36	327	GBCD724	317
E503003 010S1	274	GAADD48	327	GBCD736	317
E503005 010S1	274	GAADD60	327	GBCD748	317
E504001 010S1	274	GAADD72	327	GBCD760	317
E504002 010S1	274	GAAD12	327	GBCD772	317
E504003 010S1	274	GAAD24	327	GBCD812	317
E504005 010S1	274	GAAD36	327	GBCD824	317
E504025 010S1	274	GAAD48	327	GBCD836	317
E505001 010S1	274	GAAD60	327	GBCD848	317
E505002 010S1	274	GAAD72	327	GBCD860	317
E505003 010S1	274	GAAE184	327	GBCD872	317
E505005 010S1	274	GAAE196	327	GBCDD12	317
E506001 010S1	274	GAAE284	327	GBCDD24	317
E506002 010S1	274	GAAE296	327	GBCDD36	317
E506003 010S1	274	GAAE784	327	GBCDD48	317
E506005 010S1	274	GAAE796	327	GBCDD60	317
E506025 010S1	274	GAAE884	327	GBCDD72	317
E507001 010S1	274	GAAE896	327	GBCDE12	317
E507002 010S1	274	GAAED84	327	GBCDE24	317
E507003 010S1	274	GAAED96	327	GBCDE36	317
E507005 010S1	274	GAAEE84	327	GBCDE48	317
E600001 010S1	273	GAAEE96	327	GBCDE60	317
E600002 010S1	273	GAAG106	327	GBCDE72	317
E600003 010S1	273	GAAG112	327	GBCE196	317
E600005 010S1	273	GAAG118	327	GBCE296	317
E600025 010S1	273	GAAG124	327	GBCE896	317
E601001 010S1	273	GAAG136	327	GBCED96	317
E601002 010S1	273	GAAG206	327	GBCEE96	317
E601003 010S1	273	GAAG212	327	GBCF144	317
E601005 010S1	273	GAAG218	327	GBCF244	317
E604001 010S1	273	GAAG224	327	GBCF844	317
E604002 010S1	273	GAAG236	327	GBCFD44	317
E604003 010S1	273	GAAG706	327	GBCFE44	317
E604005 010S1	273	GAAG712	327	GBCG106	317
E604025 010S1	273	GAAG718	327	GBCG112	317
E605001 010S1	273	GAAG724	327	GBCG118	317
E605002 010S1	273	GAAG736	327	GBCG124	317
E605003 010S1	273	GAAG806	327	GBCG136	317
E605005 010S1	273	GAAG812	327	GBCG206	317
GAAD112	327	GAAG818	327	GBCG212	317
GAAD124	327	GAAG824	327	GBCG218	317
GAAD136	327	GAAG836	327	GBCG224	317
GAAD148	327	GAAGD06	327	GBCG236	317
GAAD160	327	GAAGD12	327	GBCG706	317
GAAD172	327	GAAGD18	327	GBCG712	317
GAAD212	327	GAAGD24	327	GBCG718	317
GAAD224	327	GAAGD36	327	GBCG724	317
GAAD236	327	GAAGE06	327	GBCG736	317
GAAD248	327	GAAGE12	327	GBCG806	317
GAAD260	327	GAAGE18	327	GBCG812	317
GAAD272	327	GAAGE24	327	GBCG818	317
GAAD712	327	GAAGE36	327	GBCG824	317
GAAD724	327	GBCD112	317	GBCG836	317
GAAD736	327	GBCD124	317	GBCGD06	317
GAAD748	327	GBCD136	317	GBCGD12	317
GAAD760	327	GBCD148	317	GBCGD18	317
GAAD772	327	GBCD160	317	GBCGD24	317
GAAD812	327	GBCD172	317	GBCGD36	317
GAAD824	327	GBCD212	317	GBCGE06	317
GAAD836	327	GBCD224	317	GBCGE12	317

Part Number Index

Part Number	Page	Part Number	Page	Part Number	Page
GBCGE18	317	GBDG736	321	GBRG112	313
GBCGE24	317	GBDG806	321	GBRG118	313
GBCGE36	317	GBDG812	321	GBRG124	313
GBDD112	321	GBDG818	321	GBRG136	313
GBDD124	321	GBDG824	321	GBRG206	313
GBDD136	321	GBDG836	321	GBRG212	313
GBDD148	321	GBDGD06	321	GBRG218	313
GBDD160	321	GBDGD12	321	GBRG224	313
GBDD172	321	GBDGD18	321	GBRG236	313
GBDD212	321	GBDGD24	321	GBRG706	313
GBDD224	321	GBDGD36	321	GBRG712	313
GBDD236	321	GBDGE06	321	GBRG718	313
GBDD248	321	GBDGE12	321	GBRG724	313
GBDD260	321	GBDGE18	321	GBRG736	313
GBDD272	321	GBDGE24	321	GBRG806	313
GBDD712	321	GBDGE36	321	GBRG812	313
GBDD724	321	GBRD112	313	GBRG818	313
GBDD736	321	GBRD124	313	GBRG824	313
GBDD748	321	GBRD136	313	GBRG836	313
GBDD760	321	GBRD148	313	GBRGD06	313
GBDD772	321	GBRD160	313	GBRGD12	313
GBDD812	321	GBRD172	313	GBRGD18	313
GBDD824	321	GBRD212	313	GBRGD24	313
GBDD836	321	GBRD224	313	GBRGD36	313
GBDD848	321	GBRD236	313	GBRGE06	313
GBDD860	321	GBRD248	313	GBRGE12	313
GBDD872	321	GBRD260	313	GBRGE18	313
GBDDD12	321	GBRD272	313	GBRGE24	313
GBDDD24	321	GBRD712	313	GBRGE36	313
GBDDD36	321	GBRD724	313	GBWD112	325
GBDDD48	321	GBRD736	313	GBWD124	325
GBDDD60	321	GBRD748	313	GBWD136	325
GBDDD72	321	GBRD760	313	GBWD148	325
GBDDE12	321	GBRD772	313	GBWD160	325
GBDDE24	321	GBRD812	313	GBWD172	325
GBDDE36	321	GBRD824	313	GBWD212	325
GBDDE48	321	GBRD836	313	GBWD224	325
GBDDE60	321	GBRD848	313	GBWD236	325
GBDDE72	321	GBRD860	313	GBWD248	325
GBDE196	321	GBRD872	313	GBWD260	325
GBDE296	321	GBRDD12	313	GBWD272	325
GBDE796	321	GBRDD24	313	GBWD712	325
GBDE896	321	GBRDD36	313	GBWD724	325
GBDED96	321	GBRDD48	313	GBWD736	325
GBDEE96	321	GBRDD60	313	GBWD748	325
GBDF144	321	GBRDD72	313	GBWD760	325
GBDF244	321	GBRDE12	313	GBWD772	325
GBDF744	321	GBRDE24	313	GBWD812	325
GBDF844	321	GBRDE36	313	GBWD824	325
GBDFD44	321	GBRDE48	313	GBWD836	325
GBDFE44	321	GBRDE60	313	GBWD848	325
GBDG106	321	GBRDE72	313	GBWD860	325
GBDG112	321	GBRE196	313	GBWD872	325
GBDG118	321	GBRE296	313	GBWDD12	325
GBDG124	321	GBRE796	313	GBWDD24	325
GBDG136	321	GBRE896	313	GBWDD36	325
GBDG206	321	GBRED96	313	GBWDD48	325
GBDG212	321	GBREE96	313	GBWDD60	325
GBDG218	321	GBRF144	313	GBWDD72	325
GBDG224	321	GBRF244	313	GBWDE12	325
GBDG236	321	GBRF744	313	GBWDE24	325
GBDG706	321	GBRF844	313	GBWDE36	325
GBDG712	321	GBRFD44	313	GBWDE48	325
GBDG718	321	GBRFE44	313	GBWDE60	325
GBDG724	321	GBRG106	313	GBWDE72	325

Part Number	Page	Part Number	Page	Part Number	Page
GBWG106	325	GCCDE72	315	GCDD860	319
GBWG112	325	GCCCE196	315	GCDD872	319
GBWG118	325	GCCCE296	315	GCDDD12	319
GBWG124	325	GCCCE796	315	GCDDD24	319
GBWG136	325	GCCCE896	315	GCDDD36	319
GBWG206	325	GCCCE96	315	GCDDD48	319
GBWG212	325	GCCCE96	315	GCDDD60	319
GBWG218	325	GCCCF144	315	GCDDD72	319
GBWG224	325	GCCCF244	315	GCDE12	319
GBWG236	325	GCCCF744	315	GCDE24	319
GBWG706	325	GCCF844	315	GCDE36	319
GBWG712	325	GCCFD44	315	GCDE48	319
GBWG718	325	GCCFE44	315	GCDE60	319
GBWG724	325	GCCG106	315	GCDE72	319
GBWG736	325	GCCG112	315	GCDE196	319
GBWG806	325	GCCG118	315	GCDE296	319
GBWG812	325	GCCG124	315	GCDE796	319
GBWG818	325	GCCG136	315	GCDE896	319
GBWG824	325	GCCG206	315	GCDED96	319
GBWG836	325	GCCG212	315	GCDEE96	319
GBWGD06	325	GCCG218	315	GCDF144	319
GBWGD12	325	GCCG224	315	GCDF244	319
GBWGD18	325	GCCG236	315	GCDF744	319
GBWGD24	325	GCCG706	315	GCDF844	319
GBWGD36	325	GCCG712	315	GCDFD44	319
GBWGE06	325	GCCG718	315	GCDFE44	319
GBWGE12	325	GCCG724	315	GCDG106	319
GBWGE18	325	GCCG736	315	GCDG112	319
GBWGE24	325	GCCG806	315	GCDG118	319
GBWGE36	325	GCCG812	315	GCDG124	319
GCCD112	315	GCCG818	315	GCDG136	319
GCCD124	315	GCCG824	315	GCDG206	319
GCCD136	315	GCCG836	315	GCDG212	319
GCCD148	315	GCCGD06	315	GCDG218	319
GCCD160	315	GCCGD12	315	GCDG224	319
GCCD172	315	GCCGD18	315	GCDG236	319
GCCD212	315	GCCGD24	315	GCDG706	319
GCCD224	315	GCCGD36	315	GCDG712	319
GCCD236	315	GCCGE06	315	GCDG718	319
GCCD248	315	GCCGE12	315	GCDG724	319
GCCD260	315	GCCGE18	315	GCDG736	319
GCCD272	315	GCCGE24	315	GCDG806	319
GCCD712	315	GCCGE36	315	GCDG812	319
GCCD724	315	GCDD112	319	GCDG818	319
GCCD736	315	GCDD124	319	GCDG824	319
GCCD748	315	GCDD136	319	GCDG836	319
GCCD760	315	GCDD148	319	GCDGD06	319
GCCD772	315	GCDD160	319	GCDGD12	319
GCCD812	315	GCDD172	319	GCDGD18	319
GCCD824	315	GCDD212	319	GCDGD24	319
GCCD836	315	GCDD224	319	GCDGD36	319
GCCD848	315	GCDD236	319	GCDGE06	319
GCCD860	315	GCDD248	319	GCDGE12	319
GCCD872	315	GCDD260	319	GCDGE18	319
GCCDD12	315	GCDD272	319	GCDGE24	319
GCCDD24	315	GCDD712	319	GCDGE36	319
GCCDD36	315	GCDD724	319	GCRD112	311
GCCDD48	315	GCDD736	319	GCRD124	311
GCCDD60	315	GCDD748	319	GCRD136	311
GCCDD72	315	GCDD760	319	GCRD148	311
GCCDE12	315	GCDD772	319	GCRD160	311
GCCDE24	315	GCDD812	319	GCRD172	311
GCCDE36	315	GCDD824	319	GCRD212	311
GCCDE48	315	GCDD836	319	GCRD224	311
GCCDE60	315	GCDD848	319	GCRD236	311

Part Number Index

Part Number	Page	Part Number	Page	Part Number	Page
GCRD248	311	GCRGE12	311	GCWGE06	323
GCRD260	311	GCRGE18	311	GCWGE12	323
GCRD272	311	GCRGE24	311	GCWGE18	323
GCRD712	311	GCRGE36	311	GCWGE24	323
GCRD724	311	GCWD112	323	GCWGE36	323
GCRD736	311	GCWD124	323	GDCD112	317
GCRD748	311	GCWD136	323	GDCD124	317
GCRD760	311	GCWD148	323	GDCD136	317
GCRD772	311	GCWD160	323	GDCD148	317
GCRD812	311	GCWD172	323	GDCD160	317
GCRD824	311	GCWD212	323	GDCD172	317
GCRD836	311	GCWD224	323	GDCD212	317
GCRD848	311	GCWD236	323	GDCD224	317
GCRD860	311	GCWD248	323	GDCD236	317
GCRD872	311	GCWD260	323	GDCD248	317
GCRDD12	311	GCWD272	323	GDCD260	317
GCRDD24	311	GCWD712	323	GDCD272	317
GCRDD36	311	GCWD724	323	GDCD712	317
GCRDD48	311	GCWD736	323	GDCD724	317
GCRDD60	311	GCWD748	323	GDCD736	317
GCRDD72	311	GCWD760	323	GDCD748	317
GCRDE12	311	GCWD772	323	GDCD760	317
GCRDE24	311	GCWD812	323	GDCD772	317
GCRDE36	311	GCWD824	323	GDCD812	317
GCRDE48	311	GCWD836	323	GDCD824	317
GCRDE60	311	GCWD848	323	GDCD836	317
GCRDE72	311	GCWD860	323	GDCD848	317
GCRE144	311	GCWD872	323	GDCD860	317
GCRE196	311	GCWDD12	323	GDCD872	317
GCRE244	311	GCWDD24	323	GDCDD12	317
GCRE296	311	GCWDD36	323	GDCDD24	317
GCRE796	311	GCWDD48	323	GDCDD36	317
GCRE896	311	GCWDD60	323	GDCDD48	317
GCRE96	311	GCWDD72	323	GDCDD60	317
GCRF744	311	GCWDE12	323	GDCDD72	317
GCRF844	311	GCWDE24	323	GDCDE12	317
GCRFD44	311	GCWDE36	323	GDCDE24	317
GCRFE44	311	GCWDE48	323	GDCDE36	317
GCRG106	311	GCWDE60	323	GDCDE48	317
GCRG112	311	GCWDE72	323	GDCDE60	317
GCRG118	311	GCWGE106	323	GDCDE72	317
GCRG124	311	GCWG112	323	GDCE196	317
GCRG136	311	GCWG118	323	GDCE296	317
GCRG206	311	GCWG124	323	GDCE896	317
GCRG212	311	GCWG136	323	GDCE96	317
GCRG218	311	GCWG206	323	GDCEE96	317
GCRG224	311	GCWG212	323	GDCF144	317
GCRG236	311	GCWG218	323	GDCF244	317
GCRG706	311	GCWG224	323	GDCF844	317
GCRG712	311	GCWG236	323	GDCF444	317
GCRG718	311	GCWG706	323	GDCFE44	317
GCRG724	311	GCWG712	323	GDCG106	317
GCRG736	311	GCWG718	323	GDCG112	317
GCRG806	311	GCWG724	323	GDCG118	317
GCRG812	311	GCWG736	323	GDCG124	317
GCRG818	311	GCWG806	323	GDCG136	317
GCRG824	311	GCWG812	323	GDCG206	317
GCRG836	311	GCWG818	323	GDCG212	317
GCRGD06	311	GCWG824	323	GDCG218	317
GCRGD12	311	GCWG836	323	GDCG224	317
GCRGD18	311	GCWGD06	323	GDCG236	317
GCRGD24	311	GCWGD12	323	GDCG706	317
GCRGD36	311	GCWGD18	323	GDCG712	317
GCRGE06	311	GCWGD24	323	GDCG718	317
		GCWGD36	323	GDCG724	317

Part Number	Page	Part Number	Page	Part Number	Page
GDCG736	317	GDDG112	321	GDRE196	313
GDCG806	317	GDDG118	321	GDRE296	313
GDCG812	317	GDDG124	321	GDRE796	313
GDCG818	317	GDDG136	321	GDRE896	313
GDCG824	317	GDDG206	321	GDRED96	313
GDCG836	317	GDDG212	321	GDREE96	313
GDCGD06	317	GDDG218	321	GDRF144	313
GDCGD12	317	GDDG224	321	GDRF244	313
GDCGD18	317	GDDG236	321	GDRF744	313
GDCGD24	317	GDDG706	321	GDRF844	313
GDCGD36	317	GDDG712	321	GDRFD44	313
GDCGE06	317	GDDG718	321	GDRFE44	313
GDCGE12	317	GDDG724	321	GDRG106	313
GDCGE18	317	GDDG736	321	GDRG112	313
GDCGE24	317	GDDG806	321	GDRG118	313
GDCGE36	317	GDDG812	321	GDRG124	313
GDDD112	321	GDDG818	321	GDRG136	313
GDDD124	321	GDDG824	321	GDRG206	313
GDDD136	321	GDDG836	321	GDRG212	313
GDDD148	321	GDDGD06	321	GDRG218	313
GDDD160	321	GDDGD12	321	GDRG224	313
GDDD172	321	GDDGD18	321	GDRG236	313
GDDD212	321	GDDGD24	321	GDRG706	313
GDDD224	321	GDDGD36	321	GDRG712	313
GDDD236	321	GDDGE06	321	GDRG718	313
GDDD248	321	GDDGE12	321	GDRG724	313
GDDD260	321	GDDGE18	321	GDRG736	313
GDDD272	321	GDDGE24	321	GDRG806	313
GDDD712	321	GDDGE36	321	GDRG812	313
GDDD724	321	GDRD112	313	GDRG818	313
GDDD736	321	GDRD124	313	GDRG824	313
GDDD748	321	GDRD136	313	GDRG836	313
GDDD760	321	GDRD148	313	GDRGD06	313
GDDD772	321	GDRD160	313	GDRGD12	313
GDDD812	321	GDRD172	313	GDRGD18	313
GDDD824	321	GDRD212	313	GDRGD24	313
GDDD836	321	GDRD224	313	GDRGD36	313
GDDD848	321	GDRD236	313	GDRGE06	313
GDDD860	321	GDRD248	313	GDRGE12	313
GDDD872	321	GDRD260	313	GDRGE18	313
GDDD12	321	GDRD272	313	GDRGE24	313
GDDDD24	321	GDRD712	313	GDRGE36	313
GDDDD36	321	GDRD724	313	GDWD112	325
GDDDD48	321	GDRD736	313	GDWD124	325
GDDDD60	321	GDRD748	313	GDWD136	325
GDDDD72	321	GDRD760	313	GDWD148	325
GDDDE12	321	GDRD772	313	GDWD160	325
GDDDE24	321	GDRD812	313	GDWD172	325
GDDDE36	321	GDRD824	313	GDWD212	325
GDDDE48	321	GDRD836	313	GDWD224	325
GDDDE60	321	GDRD848	313	GDWD236	325
GDDDE72	321	GDRD860	313	GDWD248	325
GDDE196	321	GDRD872	313	GDWD260	325
GDDE296	321	GDRDD12	313	GDWD272	325
GDDE796	321	GDRDD24	313	GDWD712	325
GDDE896	321	GDRDD36	313	GDWD724	325
GDDED96	321	GDRDD48	313	GDWD736	325
GDDEE96	321	GDRDD60	313	GDWD748	325
GDDF144	321	GDRDD72	313	GDWD760	325
GDDF244	321	GDRDE12	313	GDWD772	325
GDDF744	321	GDRDE24	313	GDWD812	325
GDDF844	321	GDRDE36	313	GDWD824	325
GDDFD44	321	GDRDE48	313	GDWD836	325
GDDFE44	321	GDRDE60	313	GDWD848	325
GDDG106	321	GDRDE72	313	GDWD860	325

Part Number Index

Part Number	Page	Part Number	Page	Part Number	Page
GDWD872	325	GMSN804	289	GOCBE06	293
GDWDD12	325	GMSN806	289	GOCBE08	293
GDWDD24	325	GMSN808	289	GOCBE12	293
GDWDD36	325	GMSN812	289	GOCBE16	293
GDWDD48	325	GMSN816	289	GOCBE24	293
GDWDD60	325	GMSN824	289	GOCN104	293
GDWDD72	325	GMSND02	289	GOCN106	293
GDWDE12	325	GMSND04	289	GOCN108	293
GDWDE24	325	GMSND06	289	GOCN112	293
GDWDE36	325	GMSND08	289	GOCN116	293
GDWDE48	325	GMSND12	289	GOCN124	293
GDWDE60	325	GMSND16	289	GOCN204	293
GDWDE72	325	GMSND24	289	GOCN206	293
GDWG106	325	GMSNE02	289	GOCN208	293
GDWG112	325	GMSNE04	289	GOCN212	293
GDWG118	325	GMSNE06	289	GOCN216	293
GDWG124	325	GMSNE08	289	GOCN224	293
GDWG136	325	GMSNE12	289	GOCN704	293
GDWG206	325	GMSNE16	289	GOCN706	293
GDWG212	325	GMSNE24	289	GOCN708	293
GDWG218	325	GMSNF02	289	GOCN712	293
GDWG224	325	GMSNF04	289	GOCN716	293
GDWG236	325	GMSNF06	289	GOCN724	293
GDWG706	325	GMSNF08	289	GOCN804	293
GDWG712	325	GMSNF12	289	GOCN806	293
GDWG718	325	GMSNF16	289	GOCN808	293
GDWG724	325	GMSNF24	289	GOCN812	293
GDWG736	325	GMSNI02	289	GOCN816	293
GDWG806	325	GMSNI04	289	GOCN824	293
GDWG812	325	GMSNI06	289	GOCND04	293
GDWG818	325	GMSNI08	289	GOCND06	293
GDWG824	325	GMSNI12	289	GOCND08	293
GDWG836	325	GMSNI16	289	GOCND12	293
GDWGD06	325	GMSNI24	289	GOCND16	293
GDWGD12	325	GOCB104	293	GOCND24	293
GDWGD18	325	GOCB106	293	GOCNE04	293
GDWGD24	325	GOCB108	293	GOCNE06	293
GDWGD36	325	GOCB112	293	GOCNE08	293
GDWGE06	325	GOCB116	293	GOCNE12	293
GDWGE12	325	GOCB124	293	GOCNE16	293
GDWGE18	325	GOCB204	293	GOCNE24	293
GDWGE24	325	GOCB206	293	GODB104	297
GDWGE36	325	GOCB208	293	GODB106	297
GMSN102	289	GOCB212	293	GODB108	297
GMSN104	289	GOCB216	293	GODB112	297
GMSN106	289	GOCB224	293	GODB116	297
GMSN108	289	GOCB704	293	GODB124	297
GMSN112	289	GOCB706	293	GODB204	297
GMSN116	289	GOCB708	293	GODB206	297
GMSN124	289	GOCB712	293	GODB208	297
GMSN202	289	GOCB716	293	GODB212	297
GMSN204	289	GOCB724	293	GODB216	297
GMSN206	289	GOCB804	293	GODB224	297
GMSN208	289	GOCB806	293	GODB704	297
GMSN212	289	GOCB808	293	GODB706	297
GMSN216	289	GOCB812	293	GODB708	297
GMSN224	289	GOCB816	293	GODB712	297
GMSN702	289	GOCB824	293	GODB716	297
GMSN704	289	GOCBD04	293	GODB724	297
GMSN706	289	GOCBD06	293	GODB804	297
GMSN708	289	GOCBD08	293	GODB806	297
GMSN712	289	GOCBD12	293	GODB808	297
GMSN716	289	GOCBD16	293	GODB812	297
GMSN724	289	GOCBD24	293	GODB816	297
GMSN802	289	GOCBE04	293	GODB824	297

Part Number	Page	Part Number	Page	Part Number	Page
GODBD04	297	GOFB724	309	GOHN216	301
GODBD06	297	GOFB804	309	GOHN224	301
GODBD08	297	GOFB806	309	GOHN704	301
GODBD12	297	GOFB808	309	GOHN706	301
GODBD16	297	GOFB812	309	GOHN708	301
GODBD24	297	GOFB816	309	GOHN712	301
GODBE04	297	GOFB824	309	GOHN716	301
GODBE06	297	GOFBD04	309	GOHN724	301
GODBE08	297	GOFBD06	309	GOHN804	301
GODBE12	297	GOFBD08	309	GOHN806	301
GODBE16	297	GOFBD12	309	GOHN808	301
GODBE24	297	GOFBD16	309	GOHN812	301
GODN104	297	GOFBD24	309	GOHN816	301
GODN106	297	GOFBE04	309	GOHN824	301
GODN108	297	GOFBE06	309	GOHND04	301
GODN112	297	GOFBE08	309	GOHND06	301
GODN116	297	GOFBE12	309	GOHND08	301
GODN124	297	GOFBE16	309	GOHND12	301
GODN204	297	GOFBE24	309	GOHND16	301
GODN206	297	GOFN104	309	GOHND24	301
GODN208	297	GOFN106	309	GOHNE04	301
GODN212	297	GOFN108	309	GOHNE06	301
GODN216	297	GOFN112	309	GOHNE08	301
GODN224	297	GOFN116	309	GOHNE12	301
GODN704	297	GOFN124	309	GOHNE16	301
GODN706	297	GOFN204	309	GOHNE24	301
GODN708	297	GOFN206	309	GORN102	287
GODN712	297	GOFN208	309	GORN104	287
GODN716	297	GOFN212	309	GORN106	287
GODN724	297	GOFN216	309	GORN108	287
GODN804	297	GOFN224	309	GORN112	287
GODN806	297	GOFN704	309	GORN116	287
GODN808	297	GOFN706	309	GORN124	287
GODN812	297	GOFN708	309	GORN202	287
GODN816	297	GOFN712	309	GORN204	287
GODN824	297	GOFN716	309	GORN206	287
GODND04	297	GOFN724	309	GORN208	287
GODND06	297	GOFN804	309	GORN212	287
GODND08	297	GOFN806	309	GORN216	287
GODND12	297	GOFN808	309	GORN224	287
GODND16	297	GOFN812	309	GORN702	287
GODND24	297	GOFN816	309	GORN704	287
GODNE04	297	GOFN824	309	GORN706	287
GODNE06	297	GOFND04	309	GORN708	287
GODNE08	297	GOFND06	309	GORN712	287
GODNE12	297	GOFND08	309	GORN716	287
GODNE16	297	GOFND12	309	GORN724	287
GODNE24	297	GOFND16	309	GORN802	287
GOFB104	309	GOFND24	309	GORN804	287
GOFB106	309	GOFNE04	309	GORN806	287
GOFB108	309	GOFNE06	309	GORN808	287
GOFB112	309	GOFNE08	309	GORN812	287
GOFB116	309	GOFNE12	309	GORN816	287
GOFB124	309	GOFNE16	309	GORN824	287
GOFB204	309	GOFNE24	309	GORND02	287
GOFB206	309	GOHN104	301	GORND04	287
GOFB208	309	GOHN106	301	GORND06	287
GOFB212	309	GOHN108	301	GORND08	287
GOFB216	309	GOHN112	301	GORND12	287
GOFB224	309	GOHN116	301	GORND16	287
GOFB704	309	GOHN124	301	GORND24	287
GOFB706	309	GOHN204	301	GORNE02	287
GOFB708	309	GOHN206	301	GORNE04	287
GOFB712	309	GOHN208	301	GORNE06	287
GOFB716	309	GOHN212	301	GORNE08	287

Part Number Index

Part Number	Page	Part Number	Page	Part Number	Page
GORNE12	287	GOVN724	287	GOWN206	305
GORNE16	287	GOVN802	287	GOWN208	305
GORNE24	287	GOVN804	287	GOWN212	305
GOSN102	287	GOVN806	287	GOWN216	305
GOSN104	287	GOVN808	287	GOWN224	305
GOSN106	287	GOVN812	287	GOWN704	305
GOSN108	287	GOVN816	287	GOWN706	305
GOSN112	287	GOVN824	287	GOWN708	305
GOSN116	287	GOVND02	287	GOWN712	305
GOSN124	287	GOVND04	287	GOWN716	305
GOSN202	287	GOVND06	287	GOWN724	305
GOSN204	287	GOVND08	287	GOWN804	305
GOSN206	287	GOVND12	287	GOWN806	305
GOSN208	287	GOVND16	287	GOWN808	305
GOSN212	287	GOVND24	287	GOWN812	305
GOSN216	287	GOVNE02	287	GOWN816	305
GOSN224	287	GOVNE04	287	GOWN824	305
GOSN702	287	GOVNE06	287	GOWND04	305
GOSN704	287	GOVNE08	287	GOWND06	305
GOSN706	287	GOVNE12	287	GOWND08	305
GOSN708	287	GOVNE16	287	GOWND12	305
GOSN712	287	GOVNE24	287	GOWND16	305
GOSN716	287	GOWB104	305	GOWND24	305
GOSN724	287	GOWB106	305	GOWNE04	305
GOSN802	287	GOWB108	305	GOWNE06	305
GOSN804	287	GOWB112	305	GOWNE08	305
GOSN806	287	GOWB116	305	GOWNE12	305
GOSN808	287	GOWB124	305	GOWNE16	305
GOSN812	287	GOWB204	305	GOWNE24	305
GOSN816	287	GOWB206	305	GUCB104	291
GOSN824	287	GOWB208	305	GUCB106	291
GOSND02	287	GOWB212	305	GUCB108	291
GOSND04	287	GOWB216	305	GUCB112	291
GOSND06	287	GOWB224	305	GUCB116	291
GOSND08	287	GOWB704	305	GUCB124	291
GOSND12	287	GOWB706	305	GUCB204	291
GOSND16	287	GOWB708	305	GUCB206	291
GOSND24	287	GOWB712	305	GUCB208	291
GOSNE02	287	GOWB716	305	GUCB212	291
GOSNE04	287	GOWB724	305	GUCB216	291
GOSNE06	287	GOWB804	305	GUCB224	291
GOSNE08	287	GOWB806	305	GUCB704	291
GOSNE12	287	GOWB808	305	GUCB706	291
GOSNE16	287	GOWB812	305	GUCB708	291
GOSNE24	287	GOWB816	305	GUCB712	291
GOVN102	287	GOWB824	305	GUCB716	291
GOVN104	287	GOWBD04	305	GUCB724	291
GOVN106	287	GOWBD06	305	GUCB804	291
GOVN108	287	GOWBD08	305	GUCB806	291
GOVN112	287	GOWBD12	305	GUCB808	291
GOVN116	287	GOWBD16	305	GUCB812	291
GOVN124	287	GOWBD24	305	GUCB816	291
GOVN202	287	GOWBE04	305	GUCB824	291
GOVN204	287	GOWBE06	305	GUCBD04	291
GOVN206	287	GOWBE08	305	GUCBD06	291
GOVN208	287	GOWBE12	305	GUCBD08	291
GOVN212	287	GOWBE16	305	GUCBD12	291
GOVN216	287	GOWBE24	305	GUCBD16	291
GOVN224	287	GOWN104	305	GUCBD24	291
GOVN702	287	GOWN106	305	GUCBE04	291
GOVN704	287	GOWN108	305	GUCBE06	291
GOVN706	287	GOWN112	305	GUCBE08	291
GOVN708	287	GOWN116	305	GUCBE12	291
GOVN712	287	GOWN124	305	GUCBE16	291
GOVN716	287	GOWN204	305	GUCBE24	291

Part Number	Page	Part Number	Page	Part Number	Page
GUCN104	291	GUDBD24	295	GUFB816	307
GUCN106	291	GUDBE04	295	GUFB824	307
GUCN108	291	GUDBE06	295	GUFBD04	307
GUCN112	291	GUDBE08	295	GUFBD06	307
GUCN116	291	GUDBE12	295	GUFBD08	307
GUCN124	291	GUDBE16	295	GUFBD12	307
GUCN204	291	GUDBE24	295	GUFBD16	307
GUCN206	291	GUDN104	295	GUFBD24	307
GUCN208	291	GUDN106	295	GUFBE04	307
GUCN212	291	GUDN108	295	GUFBE06	307
GUCN216	291	GUDN112	295	GUFBE08	307
GUCN224	291	GUDN116	295	GUFBE12	307
GUCN704	291	GUDN124	295	GUFBE16	307
GUCN706	291	GUDN204	295	GUFBE24	307
GUCN708	291	GUDN206	295	GUFN104	307
GUCN712	291	GUDN208	295	GUFN106	307
GUCN716	291	GUDN212	295	GUFN108	307
GUCN724	291	GUDN216	295	GUFN112	307
GUCN804	291	GUDN224	295	GUFN116	307
GUCN806	291	GUDN704	295	GUFN124	307
GUCN808	291	GUDN706	295	GUFN204	307
GUCN812	291	GUDN708	295	GUFN206	307
GUCN816	291	GUDN712	295	GUFN208	307
GUCN824	291	GUDN716	295	GUFN212	307
GUCND04	291	GUDN724	295	GUFN216	307
GUCND06	291	GUDN804	295	GUFN224	307
GUCND08	291	GUDN806	295	GUFN704	307
GUCND12	291	GUDN808	295	GUFN706	307
GUCND16	291	GUDN812	295	GUFN708	307
GUCND24	291	GUDN816	295	GUFN712	307
GUCNE04	291	GUDN824	295	GUFN716	307
GUCNE06	291	GUDND04	295	GUFN724	307
GUCNE08	291	GUDND06	295	GUFN804	307
GUCNE12	291	GUDND08	295	GUFN806	307
GUCNE16	291	GUDND12	295	GUFN808	307
GUCNE24	291	GUDND16	295	GUFN812	307
GUDB104	295	GUDND24	295	GUFN816	307
GUDB106	295	GUDBE04	295	GUFN824	307
GUDB108	295	GUDBE06	295	GUFND04	307
GUDB112	295	GUDBE08	295	GUFND06	307
GUDB116	295	GUDBE12	295	GUFND08	307
GUDB124	295	GUDBE16	295	GUFND12	307
GUDB204	295	GUDBE24	295	GUFND16	307
GUDB206	295	GUFB104	307	GUFND24	307
GUDB208	295	GUFB106	307	GUFNE04	307
GUDB212	295	GUFB108	307	GUFNE06	307
GUDB216	295	GUFB112	307	GUFNE08	307
GUDB224	295	GUFB116	307	GUFNE12	307
GUDB704	295	GUFB124	307	GUFNE16	307
GUDB706	295	GUFB204	307	GUFNE24	307
GUDB708	295	GUFB206	307	GUHA104	299
GUDB712	295	GUFB208	307	GUHA106	299
GUDB716	295	GUFB212	307	GUHA108	299
GUDB724	295	GUFB216	307	GUHA112	299
GUDB804	295	GUFB224	307	GUHA116	299
GUDB806	295	GUFB704	307	GUHA124	299
GUDB808	295	GUFB706	307	GUHA204	299
GUDB812	295	GUFB708	307	GUHA206	299
GUDB816	295	GUFB712	307	GUHA208	299
GUDB824	295	GUFB716	307	GUHA212	299
GUDBD04	295	GUFB724	307	GUHA216	299
GUDBD06	295	GUFB804	307	GUHA224	299
GUDBD08	295	GUFB806	307	GUHA704	299
GUDBD12	295	GUFB808	307	GUHA706	299
GUDBD16	295	GUFB812	307	GUHA708	299

Part Number Index

Part Number	Page	Part Number	Page	Part Number	Page
GUHA712	299	GUSL106	285	GUSN812	285
GUHA716	299	GUSL108	285	GUSN816	285
GUHA724	299	GUSL112	285	GUSN824	285
GUHA804	299	GUSL116	285	GUSND02	285
GUHA806	299	GUSL124	285	GUSND04	285
GUHA808	299	GUSL202	285	GUSND06	285
GUHA812	299	GUSL204	285	GUSND08	285
GUHA816	299	GUSL206	285	GUSND12	285
GUHA824	299	GUSL208	285	GUSND16	285
GUHAD04	299	GUSL212	285	GUSND24	285
GUHAD06	299	GUSL216	285	GUSNE02	285
GUHAD08	299	GUSL224	285	GUSNE04	285
GUHAD12	299	GUSL702	285	GUSNE06	285
GUHAD16	299	GUSL704	285	GUSNE08	285
GUHAD24	299	GUSL706	285	GUSNE12	285
GUHAE04	299	GUSL708	285	GUSNE16	285
GUHAE06	299	GUSL712	285	GUSNE24	285
GUHAE08	299	GUSL716	285	GUVN102	285
GUHAE12	299	GUSL724	285	GUVN104	285
GUHAE16	299	GUSL802	285	GUVN106	285
GUHAE24	299	GUSL804	285	GUVN108	285
GURN102	285	GUSL806	285	GUVN112	285
GURN104	285	GUSL808	285	GUVN116	285
GURN106	285	GUSL812	285	GUVN124	285
GURN108	285	GUSL816	285	GUVN202	285
GURN112	285	GUSL824	285	GUVN204	285
GURN116	285	GUSLD02	285	GUVN206	285
GURN124	285	GUSLD04	285	GUVN208	285
GURN202	285	GUSLD06	285	GUVN212	285
GURN204	285	GUSLD08	285	GUVN216	285
GURN206	285	GUSLD12	285	GUVN224	285
GURN208	285	GUSLD16	285	GUVN702	285
GURN212	285	GUSLD24	285	GUVN704	285
GURN216	285	GUSLE02	285	GUVN706	285
GURN224	285	GUSLE04	285	GUVN708	285
GURN702	285	GUSLE06	285	GUVN712	285
GURN704	285	GUSLE08	285	GUVN716	285
GURN706	285	GUSLE12	285	GUVN724	285
GURN708	285	GUSLE16	285	GUVN802	285
GURN712	285	GUSLE24	285	GUVN804	285
GURN716	285	GUSN102	285	GUVN806	285
GURN724	285	GUSN104	285	GUVN808	285
GURN802	285	GUSN106	285	GUVN812	285
GURN804	285	GUSN108	285	GUVN816	285
GURN806	285	GUSN112	285	GUVN824	285
GURN808	285	GUSN116	285	GUVND02	285
GURN812	285	GUSN124	285	GUVND04	285
GURN816	285	GUSN202	285	GUVND06	285
GURN824	285	GUSN204	285	GUVND08	285
GURND02	285	GUSN206	285	GUVND12	285
GURND04	285	GUSN208	285	GUVND16	285
GURND06	285	GUSN212	285	GUVND24	285
GURND08	285	GUSN216	285	GUVNE02	285
GURND12	285	GUSN224	285	GUVNE04	285
GURND16	285	GUSN702	285	GUVNE06	285
GURND24	285	GUSN704	285	GUVNE08	285
GURNE02	285	GUSN706	285	GUVNE12	285
GURNE04	285	GUSN708	285	GUVNE16	285
GURNE06	285	GUSN712	285	GUVNE24	285
GURNE08	285	GUSN716	285	GUWB104	303
GURNE12	285	GUSN724	285	GUWB106	303
GURNE16	285	GUSN802	285	GUWB108	303
GURNE24	285	GUSN804	285	GUWB112	303
GUSL102	285	GUSN806	285	GUWB116	303
GUSL104	285	GUSN808	285	GUWB124	303

Part Number	Page	Part Number	Page	Part Number	Page
GUWB204	303	GUWNE24	303	MIPP-04-001	337
GUWB206	303	MIPP-00-001	336	MIPP-04-002	339
GUWB208	303	MIPP-00-001	339	MIPP-05-001	341
GUWB212	303	MIPP-00-001	341	MIPP-10-001	337
GUWB216	303	MIPP-00-002	336	MIPP-10-002	337
GUWB224	303	MIPP-00-003	336	MIPP-10-003	337
GUWB704	303	MIPP-00-004	336	MIPP-10-004	337
GUWB706	303	MIPP-00-005	339	MIPP-10-005	337
GUWB708	303	MIPP-00-006	339	MIPP-10-006	337
GUWB712	303	MIPP-01-001	336	MIPP-10-007	337
GUWB716	303	MIPP-01-002	336	MIPP-10-008	337
GUWB724	303	MIPP-01-003	336	MIPP-10-009	337
GUWB804	303	MIPP-01-004	336	MIPP-10-010	337
GUWB806	303	MIPP-01-005	336	MIPP-10-011	337
GUWB808	303	MIPP-01-006	336	MIPP-10-012	337
GUWB812	303	MIPP-01-007	336	MIPP-20-001	337
GUWB816	303	MIPP-01-008	336	MIPP-21-001	341
GUWB824	303	MIPP-01-009	336	PS/PSX 45-05	72
GUWBD04	303	MIPP-01-010	336	PS/PSX 55-05	72
GUWBD06	303	MIPP-01-011	336	PS/PSX 65-05	72
GUWBD08	303	MIPP-01-012	336	PS/PSX 75-05	72
GUWBD12	303	MIPP-01-013	336	PS/PSX 85-05	72
GUWBD16	303	MIPP-01-014	336	PS/PSX 95-05	72
GUWBD24	303	MIPP-01-015	336	PS/PSX 99-07	72
GUWBE04	303	MIPP-01-016	336	PS/PSX 107-07	72
GUWBE06	303	MIPP-01-017	336	PS/PSX 112-10	72
GUWBE08	303	MIPP-01-018	336	PS/PSX 113-07	72
GUWBE12	303	MIPP-01-019	336	PS/PSX 121-07	72
GUWBE16	303	MIPP-01-020	339	PS/PSX 125-10	72
GUWBE24	303	MIPP-01-021	339	PS/PSX 138-10	72
GUWN104	303	MIPP-01-022	339	PS/PSX 138-12	72
GUWN106	303	MIPP-01-023	339	PS/PSX 156-12	72
GUWN108	303	MIPP-01-024	339	PS/PSX 174-12	72
GUWN112	303	MIPP-01-025	339	PS/PSX 174-15	72
GUWN116	303	MIPP-01-026	339	PS/PSX 188-12	72
GUWN124	303	MIPP-01-027	339	PS/PSX 188-15	72
GUWN204	303	MIPP-01-030	336	PS/PSX 200-15	72
GUWN206	303	MIPP-01-031	336	PS/PSX 218-15	72
GUWN208	303	MIPP-01-032	336	PS/PSX 219-20	72
GUWN212	303	MIPP-01-033	336	PS/PSX 236-20	72
GUWN216	303	MIPP-01-034	336	PS/PSX 247-20	72
GUWN224	303	MIPP-01-035	336	PS/PSX 261-20	72
GUWN704	303	MIPP-01-036	336	PS/PSX 263-25	72
GUWN706	303	MIPP-01-037	336	PS/PSX 280-25	72
GUWN708	303	MIPP-01-038	336	PS/PSX 296-25	72
GUWN712	303	MIPP-01-039	336	PS/PSX 297-30	72
GUWN716	303	MIPP-01-040	336	PS/PSX 311-30	72
GUWN724	303	MIPP-01-041	336	PS/PSX 327-30	72
GUWN804	303	MIPP-01-042	336	PS/PSX 343-30	72
GUWN806	303	MIPP-01-043	336	PS/PSX 359-30	72
GUWN808	303	MIPP-01-044	336	PS/PSX 375-35	72
GUWN812	303	MIPP-01-045	336	PS/PSX 392-35	72
GUWN816	303	MIPP-01-046	336	PS/PSX 412-35	72
GUWN824	303	MIPP-02-001	337	PS/PSX 423-40	72
GUWND04	303	MIPP-02-002	337	PS/PSX 437-40	72
GUWND06	303	MIPP-02-003	337	PS/PSX 451-40	72
GUWND08	303	MIPP-02-004	337	PS/PSX 462-40	72
GUWND12	303	MIPP-02-005	341	R601001 010S1	273
GUWND16	303	MIPP-02-006	337	R601002 010S1	273
GUWND24	303	MIPP-02-007	341	R601003 010S1	273
GUWNE04	303	MIPP-02-008	337	R601005 010S1	273
GUWNE06	303	MIPP-02-009	341	R605001 010S1	273
GUWNE08	303	MIPP-02-010	339	R605002 010S1	273
GUWNE12	303	MIPP-02-011	341	R605003 010S1	273
GUWNE16	303	MIPP-03-001	341	R605005 010S1	273

Part Number Index

Part Number	Page	Part Number	Page
ST050-462	72	ST400-486	72
ST050-464	72	TMC165	72
ST050-465	72	TMC285	72
ST050-466	72	TMC3112	72
ST075-467	72	TMC4140	72
ST075-468	72	TMC5161	72
ST100-469	72	TMC6206	72
ST125-470	72	TMC7247	72
ST125-471	72	TMC8302	72
ST125-550	72	TMC9352	72
ST150-472	72	TMC10402	72
ST150-473	72	TMCX165	72
ST200-474	72	TMCX285	72
ST200-475	72	TMCX3112	72
ST200-476	72	TMCX4140	72
ST200-551	72	TMCX5161	72
ST250-477	72	TMCX6206	72
ST250-478	72	TMCX7247	72
ST300-479	72	TMCX8302	72
ST300-480	72	TMCX9352	72
ST300-481	72	TMCX10402	72
ST350-482	72	YE00819	247
ST350-483	72	YE00820	247
ST400-484	72	YE00905	247
ST400-485	72	YE00906	247

GLOBAL LOCATIONS

For more information, please visit us at:
www.beldensolutions.com



**Be certain
 you stay
 in touch.**

EUROPE/MIDDLE EAST/AFRICA

The Netherlands – Head Office
 Phone: +31-773-878-555
venlo.salesinfo@belden.com

France
 Phone: +33-472-109-990
lyon.salesinfo@belden.com

Germany
 Phone: +49-7127-14-0
inet-sales@belden.com

Italy
 Phone: +39-039-5965-250
info.milano@belden.com

Russia
 Phone: +7-495-287-1391
info@belden.ru

Spain
 Phone: +34-91-746-17-30
madrid.salesinfo@belden.com

Sweden
 Phone: +46-40-699-88-60
inet-sales@belden.com

United Arab Emirates
 Phone: +971-4-391-0490
dubai.salesinfo@belden.com

United Kingdom
 Phone: +44 161 4983749
manchestersalesinfo@belden.com

Americas

USA
 Phone: +1-855-400-9071
inetsalesops@belden.com

Asia/Pacific

Singapore
 Phone: +65-6879-9800
singapore.sales@belden.com

China
 Phone: +86-21-5445-2353
China.Marketing@belden.com

Belden, Belden Sending All The Right Signals, GarrettCom, Hirschmann, Tofino Security and the Belden logo are trademarks or registered trademarks of Belden Inc. or its affiliated companies in the United States and other jurisdictions. Belden and other parties may also have trademark rights in other terms used herein.